

Detecção Remota Microondas



Introdução ao Radar de abertura sintética

João Catalão Fernandes, FCUL

Tópicos

- Ondas eletromagnéticas e Equação de Maxwell
- Polarização e Interferência das ondas eletromagnéticas
- Sensores ativos e passivos
- Formação das imagens RADAR
- Interação com a superfície
- Geometria e Resolução
- Radar de Abertura Sintética
- Distorção das imagens SAR
- Mecanismos de scattering
- Speckle
- Polarização
- Missões Microondas
- Serviços Copernicus

Deteção Remota

RADAR micro-ondas

RADAR=Radio Detection And Ranging

Microwave Radar and Radiometric Remote Sensing
Fawwaz T. Ulaby, David G. Long

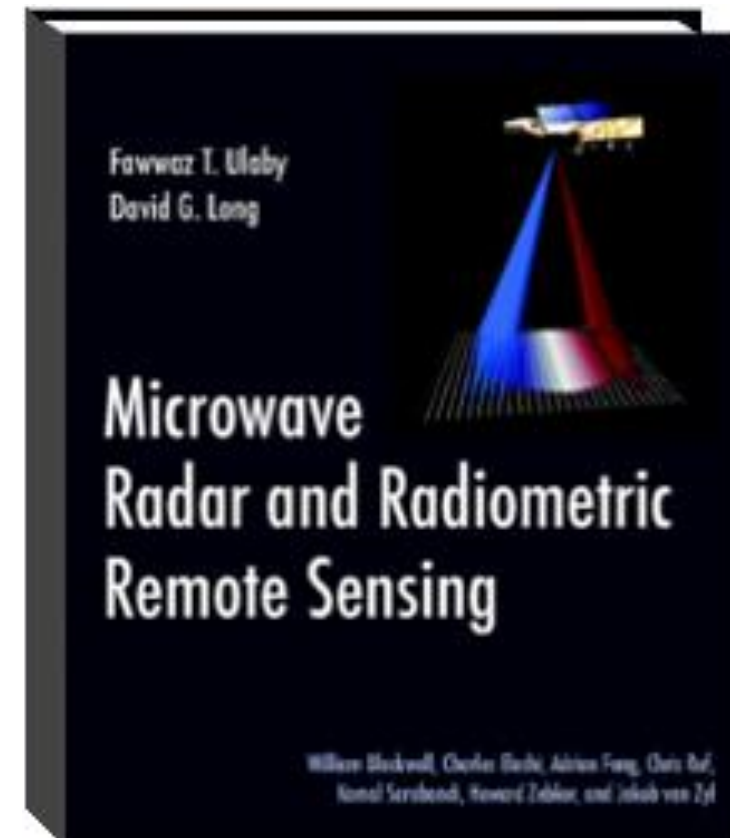



(2000)

ERS and Volcanic activities

Oceanography and sea Ice

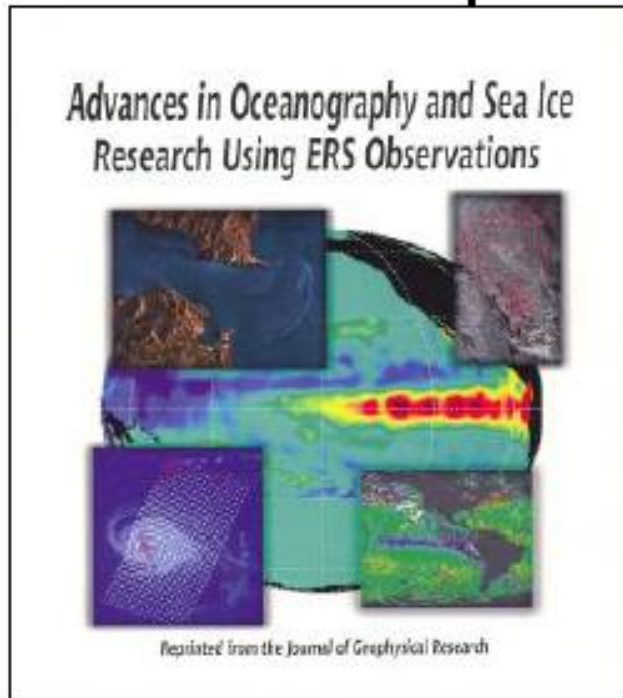

ERS and SAR Interferometry

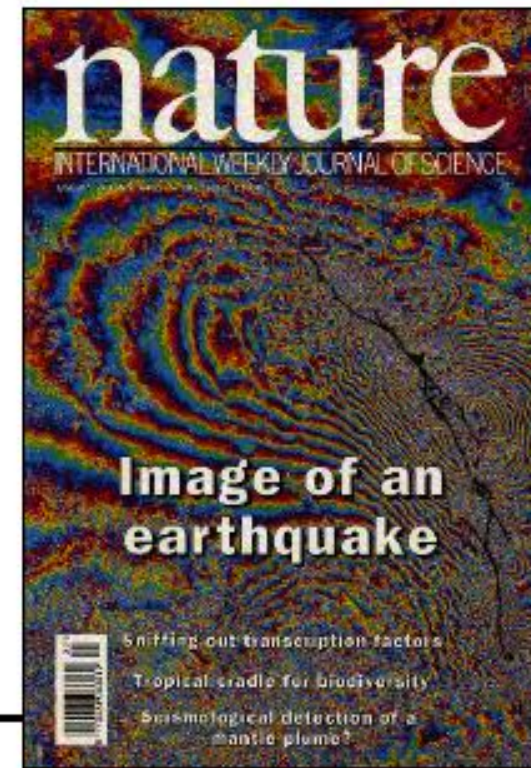

(1993)

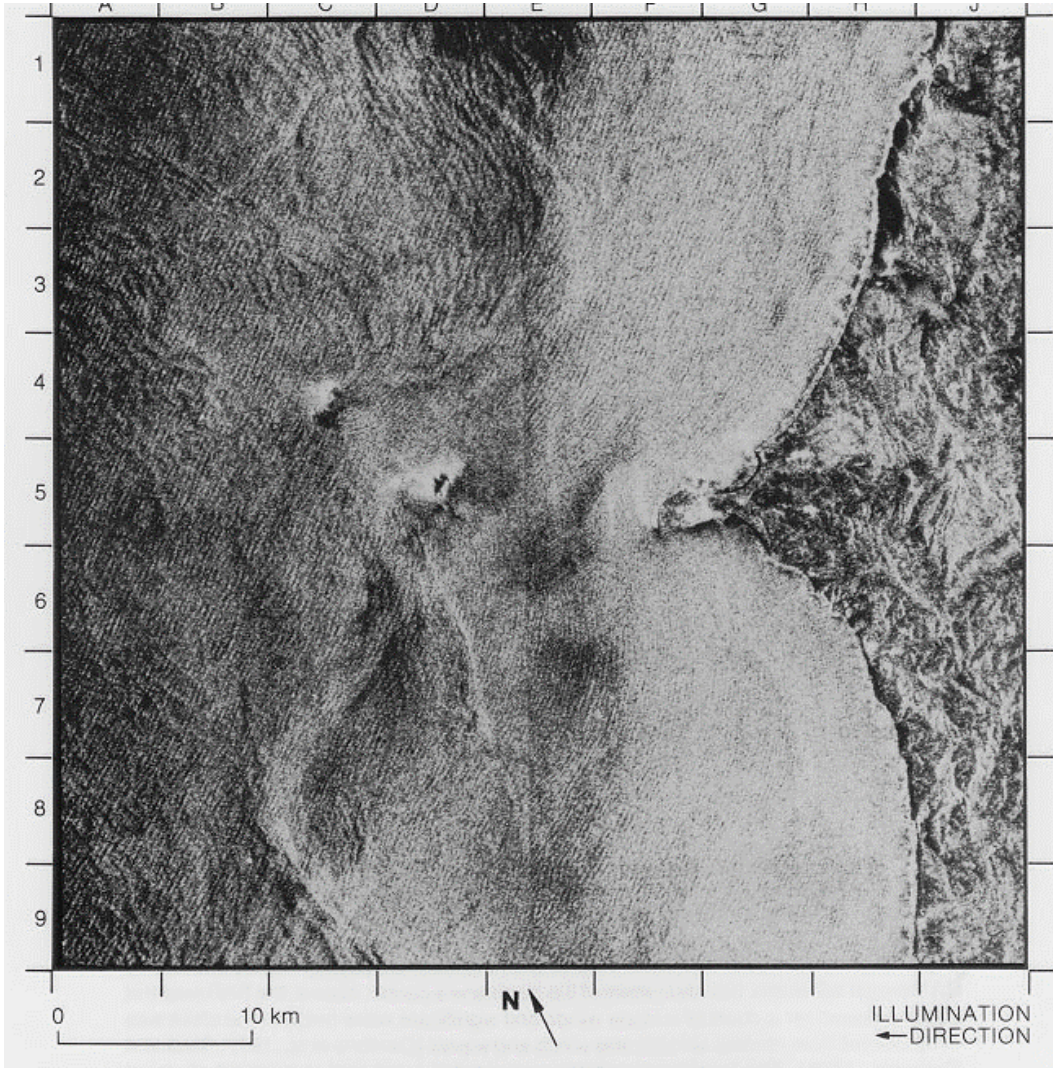

Seasat SAR

One of the microwave radars on board Seasat was a synthetic-aperture radar (SAR).

(Radar de Abertura Sintética, banda L)

The refraction of impinging deep ocean waves by varying bottom topography in near-shore areas is one of the major concerns of coastal engineers. This image shows how deep ocean waves are refracted by the bottom topography west of Portugal.

Fu, L-L, Holt, B., **1982**. Seasat Views Oceans and Sea Ice with Synthetic-Aperture Radar. JPL Publication 81-120, NASA, Jet Propulsion Laboratory, California Institute of Technology, Pasadena, California, p. 200.

Repeat Track Interferometry

Two interferograms were differenced to generate this image, which shows changes that occurred between the observations.

Yellow: no change

Black: loss coherence

Other: small motions 2-3 cm
(due to watering)

Gabriel, A., Goldstein, R., Zebker, H., **1989**. Mapping small elevation changes over large areas: Differential radar interferometry. *Journal of Geophysical Research*, VOL. 94, NO. B7, P. 9183, doi:10.1029/JB094iB07p09183.

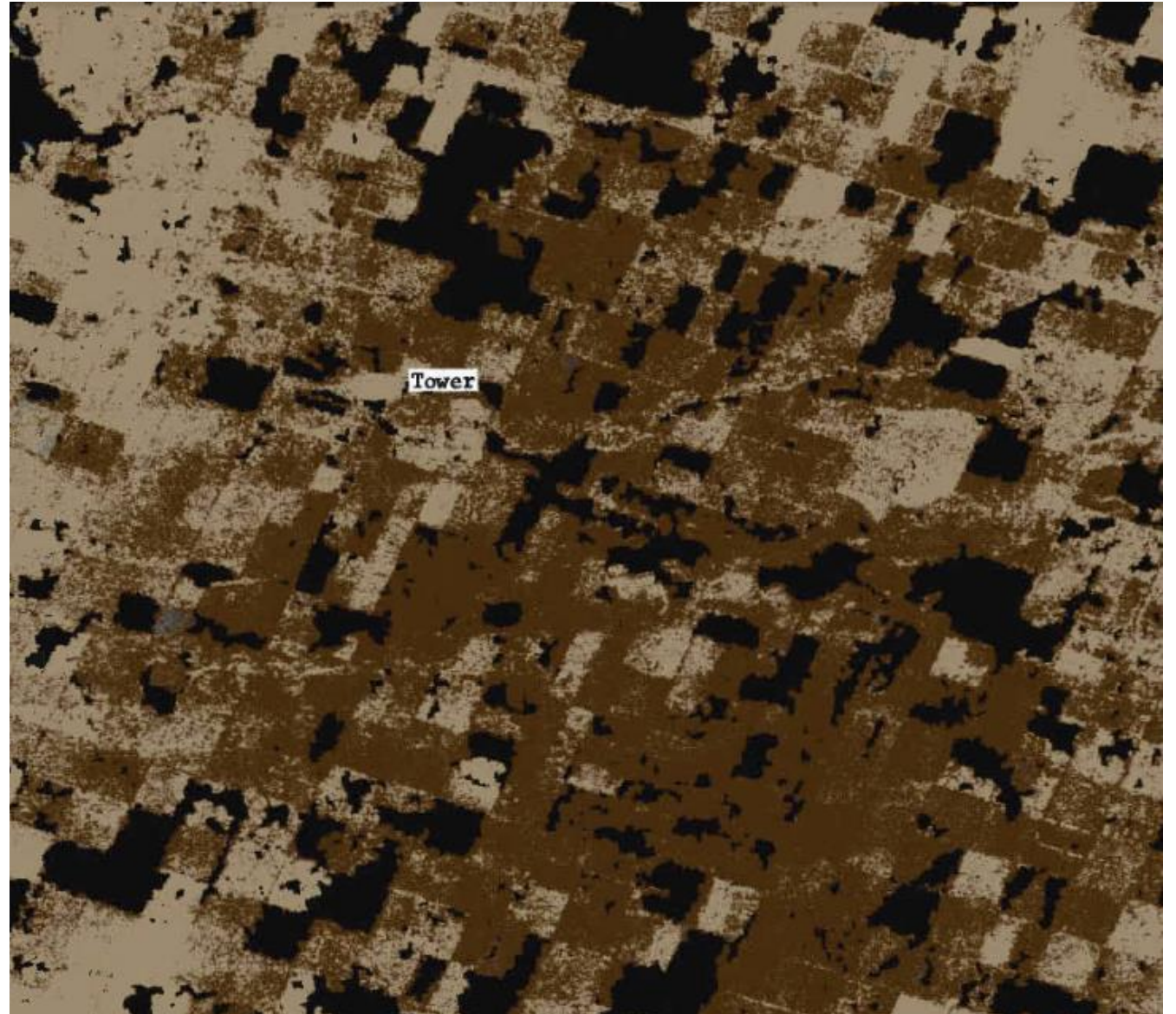

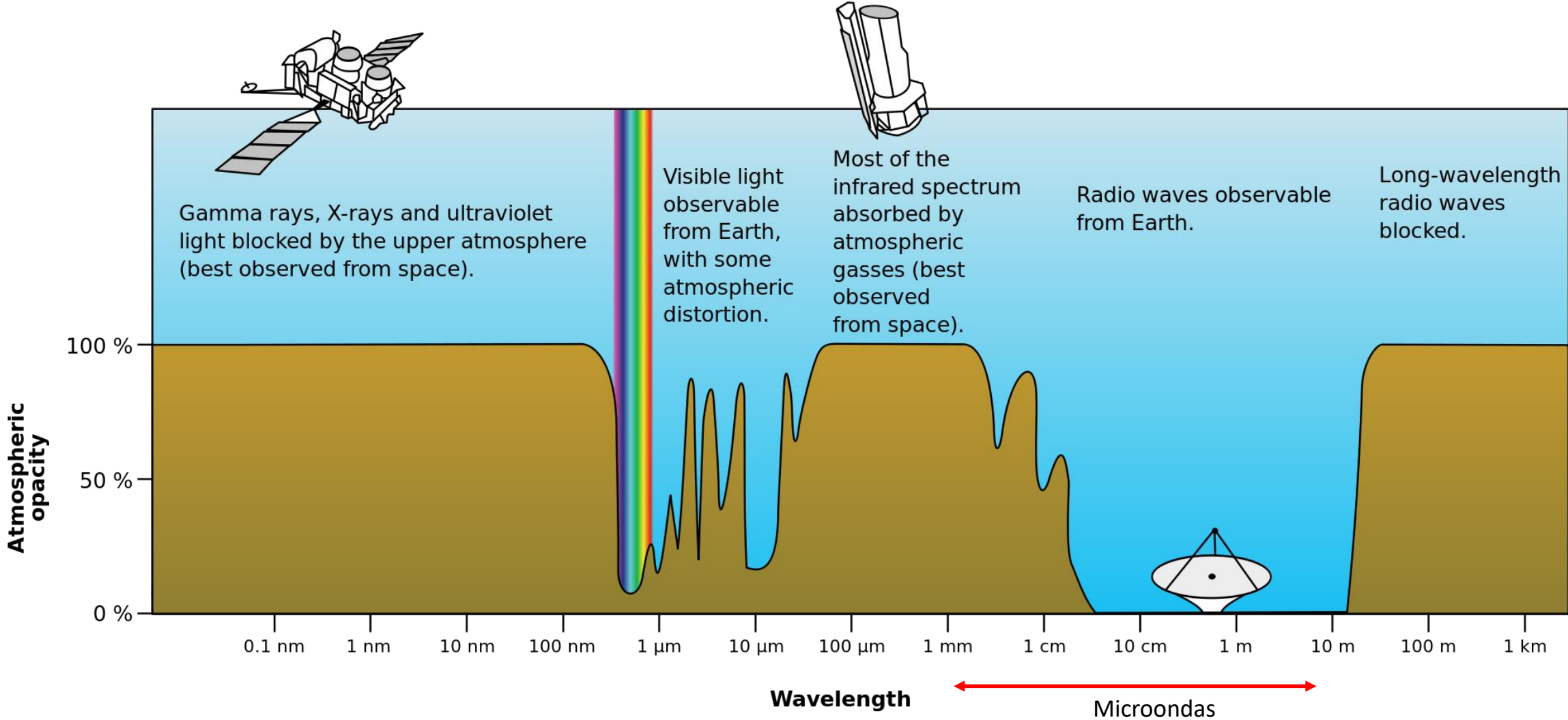

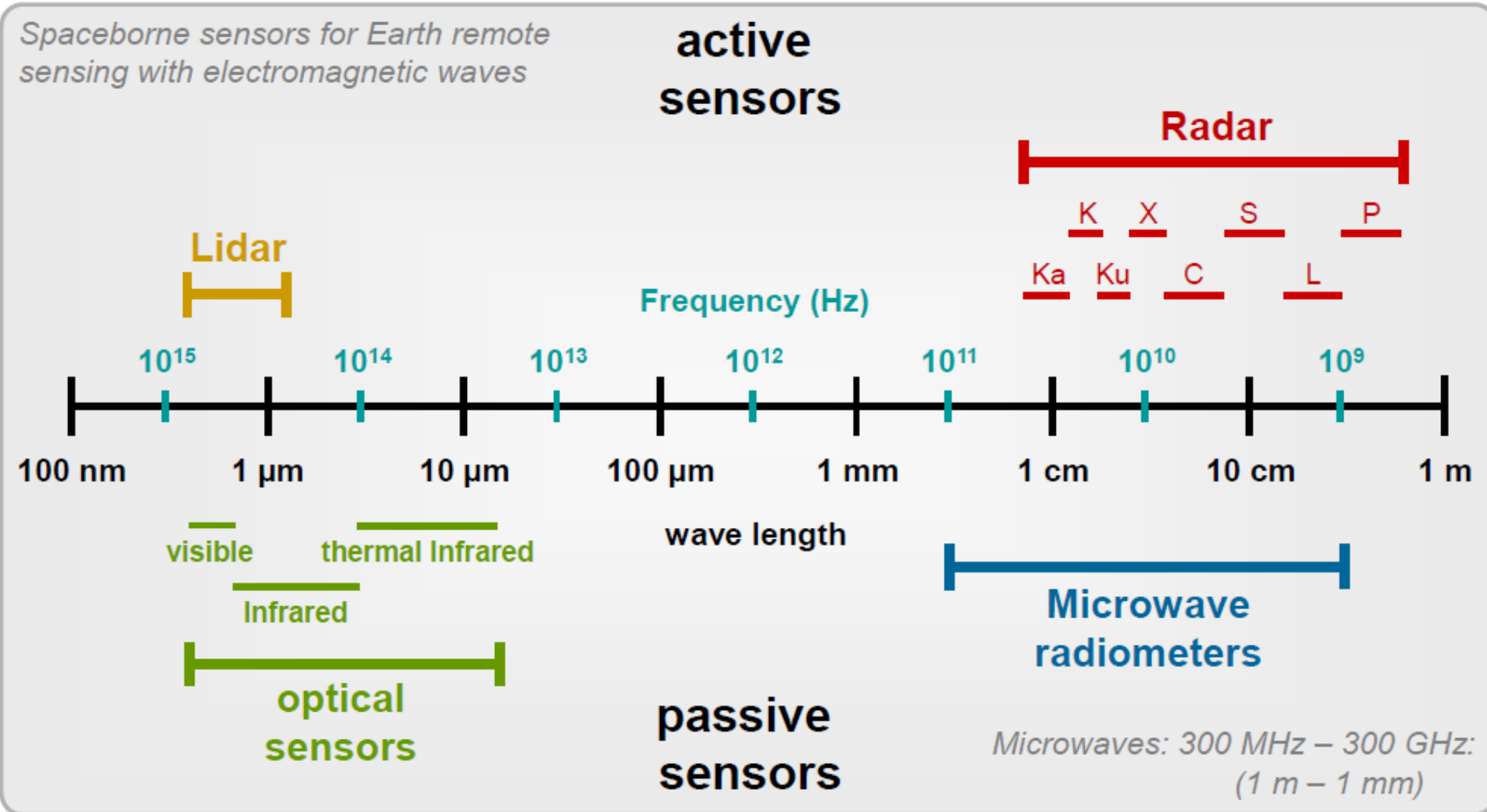

As microondas têm propriedades importantes para a DR devido ao seu grande comprimento de onda (quando comparado com o visível)



Os maiores comprimentos de onda podem atravessar nuvens, pó, "haze" ou mesmo chuva leve uma vez que os maiores c.o. não são susceptíveis à dispersão atmosférica.

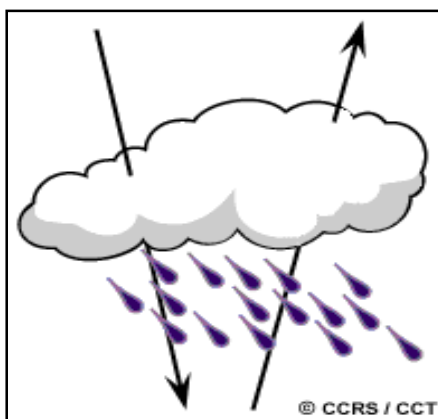

"All-weather"

"Day and Night"

In physics, radiation is the emission or transmission of energy in the form of waves or particles through space or through a material medium

In this course we are going to address systems based on electromagnetic radiation

Modelo das Partículas (Planck)

A radiação é transportada por fótons, ou quanta, que viajam à velocidade da luz e cuja energia é proporcional à frequência de oscilação.

$$Q = hf$$

+

$$c = \lambda f$$



$$Q = \frac{hc}{\lambda}$$

Q é a energia de um quantum (em Joules), h a constante de Planck (6.626×10^{-34} J.s)
f a frequência em Hz (Hertz) e c a velocidade da luz.

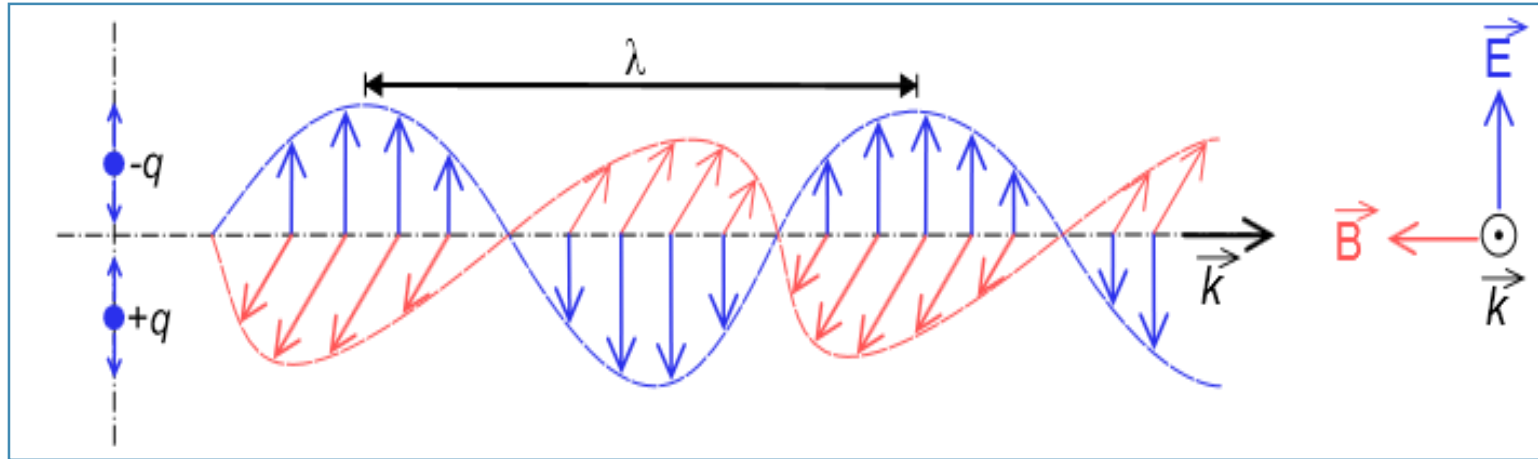

E : campo eléctrico; **B** : campo magnético; **k** : deslocamento

- Frequência (f): número de ondas completas que passam por um ponto por unidade de tempo (segundo)
- Período (T): tempo necessário para uma onda dar uma volta completa pelo mesmo ponto

Equações de Maxwell

Publicadas num artigo "On Physical Lines of Force" em 1861 (reescritas por Oliver Heaviside e Willard Gibbs , que em 1884).

$$\nabla \times \mathbf{H} = \frac{\partial \mathbf{D}}{\partial t} + \mathbf{j}$$

$$\nabla \cdot \mathbf{D} = \rho_e$$

D: deslocamento

E: campo elétrico

$$\nabla \times \mathbf{E} = -\frac{\partial \mathbf{B}}{\partial t}$$

$$\nabla \cdot \mathbf{B} = 0$$

H: campo magnético

B: indução magnética

Em que: $\nabla = \left(\frac{\partial}{\partial x}, \frac{\partial}{\partial y}, \frac{\partial}{\partial z} \right)$ é o operador Nabla, usado

Como rotacional $\nabla \times$ e divergência $\nabla \cdot$, \mathbf{j} é a densidade da corrente elétrica e ρ_e a densidade da carga elétrica.

Para um meio homogéneo e isotrópico distante de qualquer fonte emissora, os campos **D** e **H** estão relacionados com os campos **E** e **B** pelas expressões:

$$\mathbf{D} = \varepsilon \mathbf{E}$$

$$\mathbf{B} = \mu \mathbf{H}$$

Deslocamento \approx Campo Elétrico

Em que:

ε é a constante dielétrica ou permitividade elétrica e
 μ é a permeabilidade magnética.

No caso do vácuo, que é um meio linear, homogéneo e isotrópico, as constantes elétricas são designadas por ε_0 e μ_0 .

$$\vec{\nabla} \cdot \vec{E} = 0 \Leftrightarrow \frac{\partial E_x}{\partial x} + \frac{\partial E_y}{\partial y} + \frac{\partial E_z}{\partial z} = 0$$

$$\vec{\nabla} \cdot \vec{B} = 0 \Leftrightarrow \frac{\partial B_x}{\partial x} + \frac{\partial B_y}{\partial y} + \frac{\partial B_z}{\partial z} = 0$$

$$\nabla \times \mathbf{E} = -\frac{\partial \mathbf{B}}{\partial t} \quad \vec{\nabla} \times \vec{E} = -\frac{\partial \vec{B}}{\partial t} \Leftrightarrow \begin{vmatrix} \hat{i} & \hat{j} & \hat{k} \\ \frac{\partial}{\partial x} & \frac{\partial}{\partial y} & \frac{\partial}{\partial z} \\ E_x & E_y & E_z \end{vmatrix} = -\frac{\partial}{\partial t} \begin{pmatrix} B_x \\ B_y \\ B_z \end{pmatrix} \Leftrightarrow \begin{matrix} \frac{\partial E_z}{\partial y} - \frac{\partial E_y}{\partial z} = -\frac{\partial B_x}{\partial t} \\ \frac{\partial E_x}{\partial z} - \frac{\partial E_z}{\partial x} = -\frac{\partial B_y}{\partial t} \\ \frac{\partial E_y}{\partial x} - \frac{\partial E_x}{\partial y} = -\frac{\partial B_z}{\partial t} \end{matrix}$$

$$\begin{matrix} \nabla \times \mathbf{H} = \frac{\partial \mathbf{D}}{\partial t} + \mathbf{j} \\ \mathbf{D} = \epsilon \mathbf{E} \\ \mathbf{B} = \mu \mathbf{H} \end{matrix} \rightarrow$$

$$\vec{\nabla} \times \vec{B} = \epsilon_0 \mu_0 \frac{\partial \vec{E}}{\partial t} \Leftrightarrow \begin{vmatrix} \hat{i} & \hat{j} & \hat{k} \\ \frac{\partial}{\partial x} & \frac{\partial}{\partial y} & \frac{\partial}{\partial z} \\ B_x & B_y & B_z \end{vmatrix} = \epsilon_0 \mu_0 \frac{\partial}{\partial t} \begin{pmatrix} E_x \\ E_y \\ E_z \end{pmatrix} \Leftrightarrow \begin{matrix} \frac{\partial B_z}{\partial y} - \frac{\partial B_y}{\partial z} = \epsilon_0 \mu_0 \frac{\partial E_x}{\partial t} \\ \frac{\partial B_x}{\partial z} - \frac{\partial B_z}{\partial x} = \epsilon_0 \mu_0 \frac{\partial E_y}{\partial t} \\ \frac{\partial B_y}{\partial x} - \frac{\partial B_x}{\partial y} = \epsilon_0 \mu_0 \frac{\partial E_z}{\partial t} \end{matrix}$$

Definições e unidades

Símbolo	Significado (o primeiro termo é o mais comum)	Unidade SI de medida
E	Campo elétrico Também chamado de intensidade de campo elétrico	volt por metro newton por coulomb
B	Campo magnético Também chamado de indução magnética Densidade de campo magnético Densidade de fluxo magnético	tesla weber por metro quadrado, volt-segundo por metro quadrado
D	Campo de deslocamento elétrico Também chamado de indução elétrica Densidade de fluxo elétrico	coulomb por metro quadrado newton por volt-metro
H	Campo magnetizante Também chamado de campo magnético auxiliar Intensidade de campo magnético Campo magnético	ampère por metro
$\nabla \cdot$	Operador divergência	"por metro"
$\nabla \times$	Operador rotacional	"por metro"
$\frac{\partial}{\partial t}$	Derivada parcial com respeito ao tempo	"por segundo" hertz
dA	Elemento vetorial diferencial da superfície "A", com magnitude infinitesimalmente pequena e direção normal à superfície "S"	metro quadrado
dI	Elemento vetorial diferencial do comprimento tangencial à curva	metro
ϵ_0	Permissividade do vácuo , também chamada de constante elétrica , uma constante universal	farad por metro coulomb ao quadrado por newton metro quadrado
μ_0	Permeabilidade do vácuo , também chamada de constante magnética , uma constante universal	henry por metro newton por ampère ao quadrado
ρ_f	Densidade de carga livre (cargas ligadas)	coulomb por metro cúbico
ρ	Densidade de carga total (incluindo cargas livres e ligadas)	coulomb por metro cúbico
J_f	Densidade de corrente livre (não incluindo correntes ligadas)	ampère por metro quadrado
J	Densidade de corrente total (incluindo correntes livres e ligadas)	ampère por metro quadrado
$Q_f(V)$	Rede de cargas elétricas livres dentro de um volume tridimensional V (não incluindo cargas ligadas)	coulomb
$Q(V)$	Rede de cargas elétricas ligadas a um volume tridimensional V (incluindo cargas livres e ligadas)	coulomb

Tabela 1 – Propriedades físicas de diversos materiais (Annan, 1992).

Material	Constante dielétrica	Condutividade elétrica (mS/m)	Velocidade (m/ns)	Atenuação (db/m)
Ar	1	0	0.3	0
Água destilada	80	0.01	0.033	$2 \cdot 10^{-3}$
Água doce	80	0.5	0.033	0.1
Areia seca	3.0–5.0	0.01	0.15	0.01
Areia saturada	20–30	0.1–1	0.06	0.03–0.3
Calcário	4.0–8.0	0.5–2	0.12	0.4–1
Folhelho	5.0–15.0	1–100	0.09	1–100
Siltito	5.0–30.0	1–100	0.07	1–100
Argila	5.0–40.0	2–1000	0.06	1–300
Granito	4.0–6.0	0.01–1	0.13	0.01–1

Assumindo a simplificação anterior as equações de Maxwell escrevem-se como:

$$-\nabla^2 \mathbf{E} = -\frac{\partial \nabla \times \mathbf{B}}{\partial t} = -\frac{\partial}{\partial t} \left(\mu_0 \epsilon_0 \frac{\partial \mathbf{E}}{\partial t} \right)$$

$$-\nabla^2 \mathbf{B} = \mu_0 \epsilon_0 \frac{\partial \nabla \times \mathbf{E}}{\partial t} = \mu_0 \epsilon_0 \left(-\frac{\partial \mathbf{B}}{\partial t} \right)$$

$$\nabla \times \begin{cases} \nabla \times \mathbf{H} = \frac{\partial \mathbf{D}}{\partial t} + \mathbf{j} \\ \nabla \times \mathbf{E} = -\frac{\partial \mathbf{B}}{\partial t} \end{cases}$$

De onde resulta a equação da onda para o campo elétrico:

$$\frac{\partial^2 \mathbf{E}}{\partial t^2} - \frac{1}{\mu_0 \epsilon_0} \nabla^2 \mathbf{E} = 0$$

$$\begin{matrix} \longrightarrow \\ c_0^2 = \frac{1}{\mu_0 \epsilon_0} \end{matrix}$$

$$\frac{\partial^2 \mathbf{E}}{\partial t^2} - c_0^2 \nabla^2 \mathbf{E} = 0$$

Equação vetorial

Comecemos por considerar uma oscilação fixa no espaço (sem propagação no espaço).

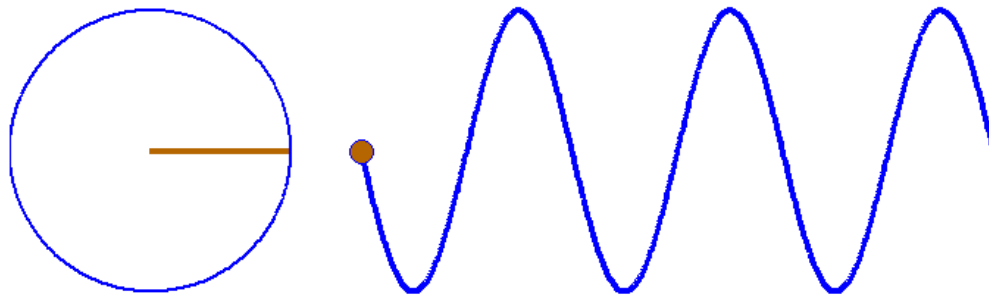

$$\frac{\partial^2 \mathbf{E}}{\partial t^2} - c_0^2 \nabla^2 \mathbf{E} = 0$$

$$c_0^2 = \frac{1}{\mu_0 \epsilon_0}$$

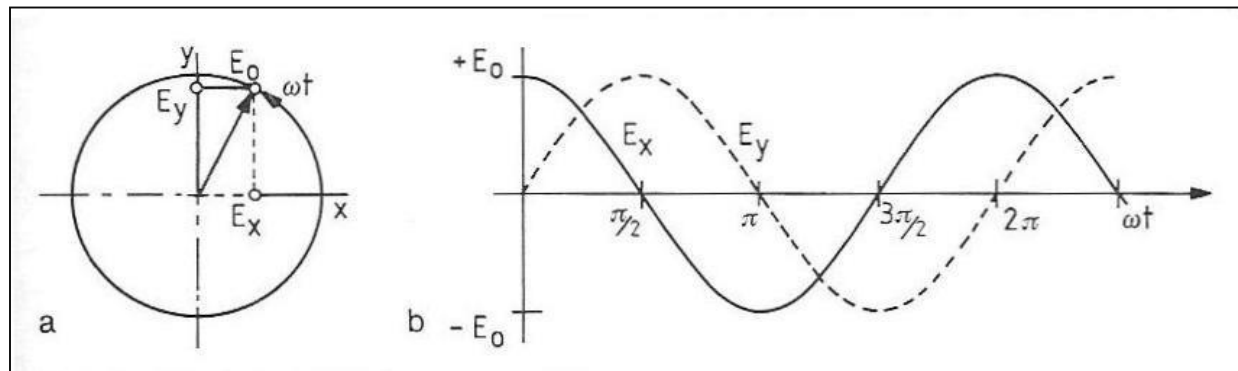

$$\frac{d^2 \mathbf{E}}{dt^2} + \omega^2 \mathbf{E} = 0$$

Em que E é o campo elétrico e ω é uma constante (frequência angular)

Uma possível solução para esta equação é: $E = E_0 \cos \omega t$

$$\frac{d^2 E}{dt^2} + \omega^2 E = 0$$

Outra possível solução seria: $E = E_0 \sin \omega t$

Para englobar as duas possíveis soluções é usual representar o movimento no plano complexo com o eixo dos x real e um eixo dos y imaginário. A solução é:

$$E = E_0 (\cos \omega t + i \sin \omega t) = E_0 \exp(i\omega t)$$

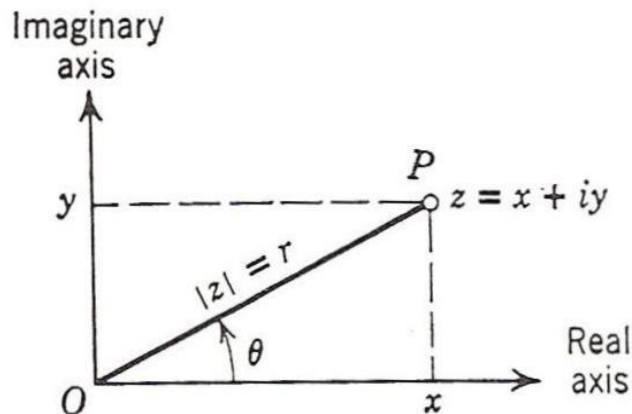

$$x = r \cos \theta; \quad y = r \sin \theta; \quad z = r (\cos \theta + i \sin \theta)$$

$$e^{iy} = \cos y + i \sin y \quad (\text{Formula de Euler})$$

$$z = r e^{i\theta}$$

Com propagação no espaço, na direção z:

$$\frac{\partial^2 \mathbf{E}}{\partial t^2} - c^2 \frac{\partial^2 \mathbf{E}}{\partial z^2} = 0$$

A solução é:

$$\mathbf{E}(z, t) = E_0 \cos(\omega t - kz)$$

Verificar esta solução

Em que k uma constante relacionada com o numero de oscilações ao longo da direção z. As equações de Maxwell ficam então:

$$\left\{ \begin{array}{l} E_x(z, t) = E_0 \cos(\omega t - kz) \\ E_y(z, t) = 0 \\ E_z(z, t) = 0 \end{array} \right.$$

$$k = \frac{2 \cdot \pi}{\lambda} \quad \text{Número de onda}$$

$$\omega = \frac{2 \cdot \pi}{T} = 2 \cdot \pi \cdot f$$

Esta solução representa uma onda que se propaga na direção z (a onda transporta a energia eletromagnética, neste sentido)

Outra solução das equações de Maxwell, rodada 90°, é: Ou seja: no plano yy.

$$\left\{ \begin{array}{l} E_x(z, t) = 0 \\ E_y(z, t) = E_0 \cos(\omega t - kz) \\ E_z(z, t) = 0 \end{array} \right.$$

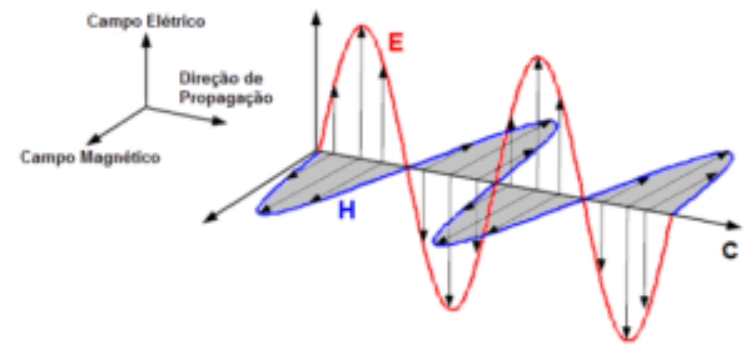

A solução geral das equações de Maxwell, é:

$$\left\{ \begin{array}{l} E_x(z, t) = E_{0,x} \cos(\omega t - kz - \varphi_x) \\ E_y(z, t) = E_{0,y} \cos(\omega t - kz - \varphi_y) \\ E_z(z, t) = 0 \end{array} \right.$$

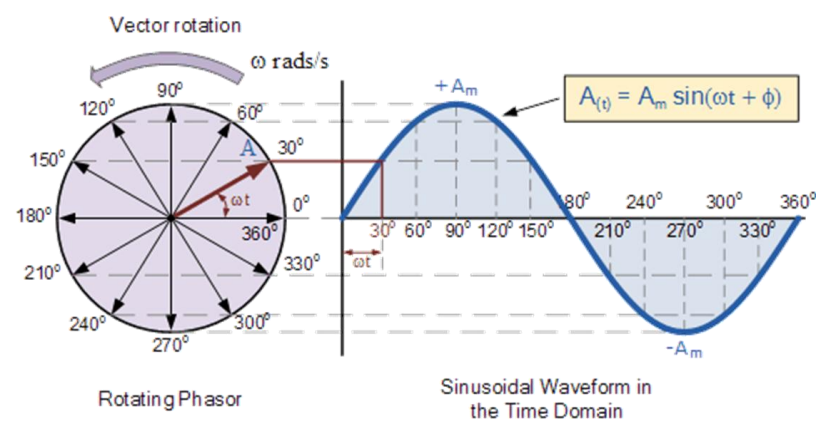

A diferença de fase $\varphi_y - \varphi_x$ determina o estado de polarização da onda eletromagnética.

A polarização é dada pela direção do campo elétrico E.

$$\begin{aligned} \varphi_y - \varphi_x &= 0 \\ \varphi_y - \varphi_x &= \pi \quad (\text{ou } -\pi) \end{aligned} \quad \Rightarrow \quad \text{Polarização linear}$$

$$\varphi_y - \varphi_x = \frac{\pi}{2} \quad \Rightarrow \quad \begin{aligned} E_{ox} &\neq E_{oy} && \text{Polarização elíptica de esquerda} \\ E_{ox} &= E_{oy} && \text{Polarização circular de esquerda} \end{aligned}$$

$$\varphi_y - \varphi_x = -\frac{\pi}{2} \quad \Rightarrow \quad \begin{aligned} E_{ox} &\neq E_{oy} && \text{Polarização elíptica de direita} \\ E_{ox} &= E_{oy} && \text{Polarização circular de direita} \end{aligned}$$

Por definição, a polarização de uma onda eletromagnética é o plano no qual se encontra a componente elétrica da onda.

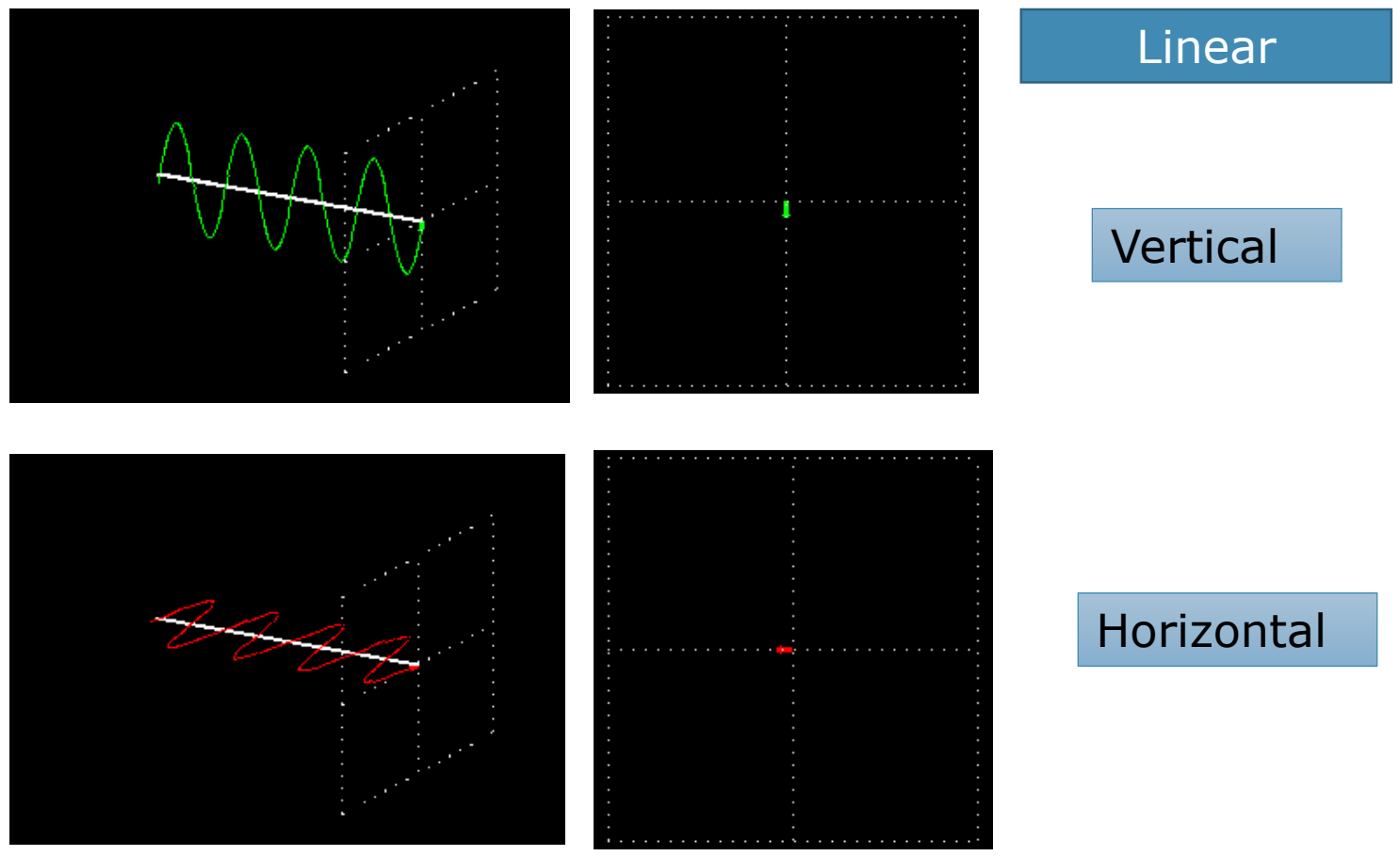

A combinação de duas ondas linearmente polarizadas, uma vertical e outra horizontal, de mesma amplitude e eletricamente desfasadas de 90 graus, $\varphi_y - \varphi_x = \frac{\pi}{2}$ resulta em uma onda circularmente polarizada.

Polarização Circular

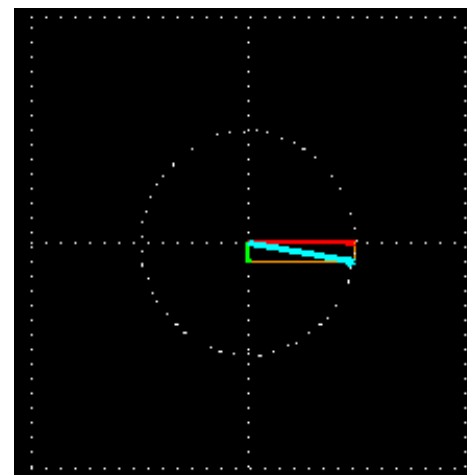
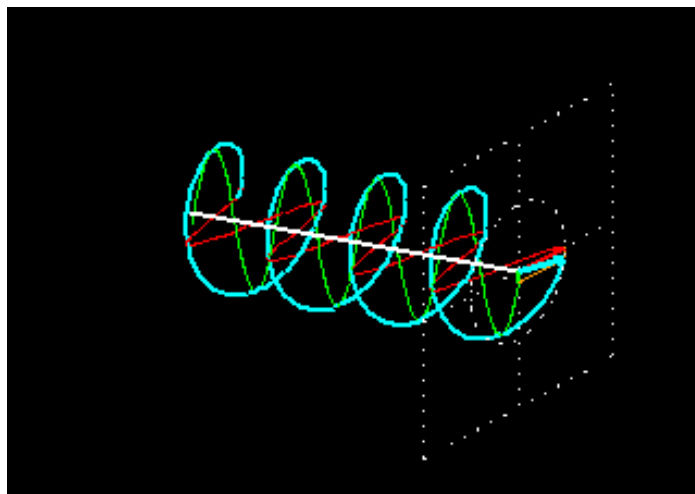

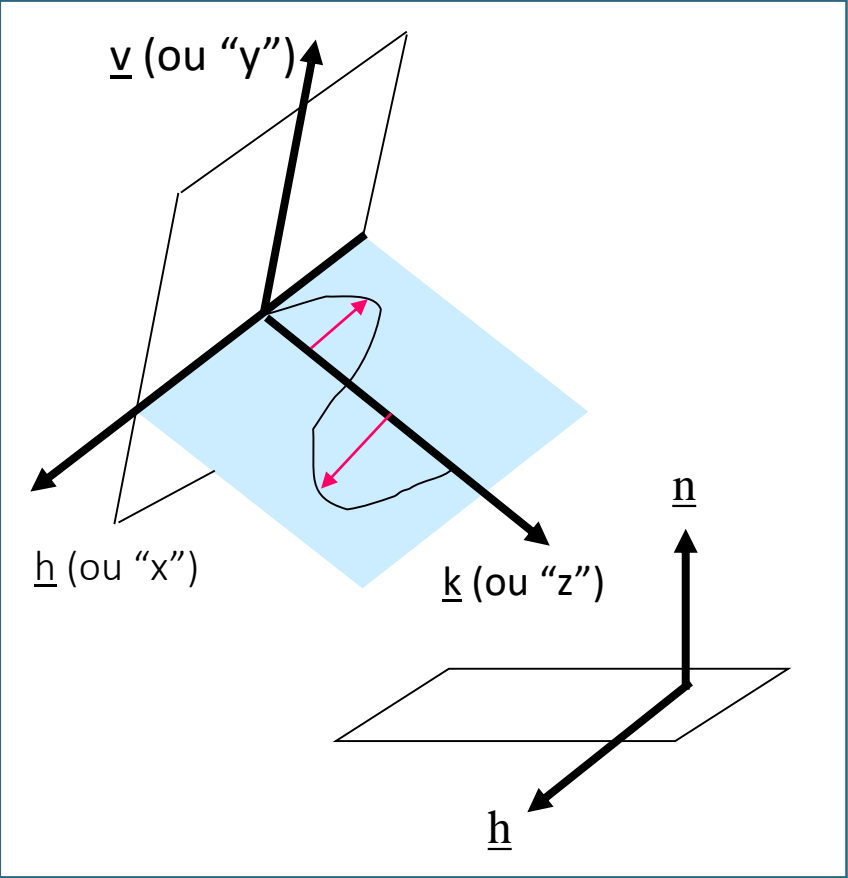

Polarização horizontal
(Ex. RADARSAT HH)

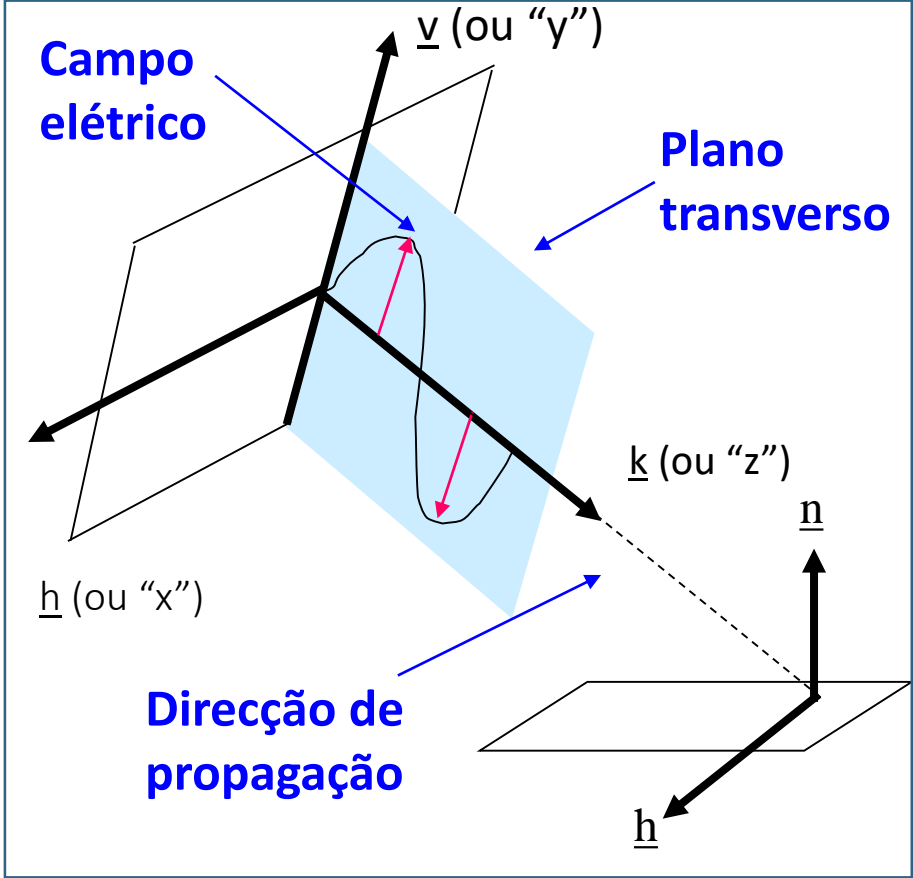

Polarização vertical
(Ex. ERS-1/2 VV)

Tejo VH



Tejo VV



Interferência

Fenómeno caracterizado por uma variação da intensidade (espacial ou temporal) da radiação eletromagnética na sequência da sobreposição de duas ondas eletromagnéticas **com a mesma frequência** e que se propagam na mesma direção. A intensidade não é igual ao somatório das intensidades de cada uma das duas ondas.

Interferência



Fontes coerentes

fontes que emitem radiação eletromagnética com uma diferença de fase constante no tempo (ou no espaço).

Exemplos de fontes coerentes são:

LASER

RADAR

Coerência Espacial

diferença de fase observada no instante t entre os pontos $P1$ e $P2$. Se essa diferença de fase se mantiver constante no tempo fala-se em coerência espacial perfeita.

Coerência Temporal

diferença de fase observada no ponto P nos instantes t e $t+\Delta t$. Se, por um dado Δt , essa diferença de fase se mantiver constante, por cada t , fala-se em coerência temporal perfeita.

As duas fontes punctiformes S1 e S2 são coerentes e monocromáticas de frequência f .

O plano AA' é paralelo ao plano que contém as fontes S1 e S2.

A distancia H é muito maior do que a separação B entre as fontes.

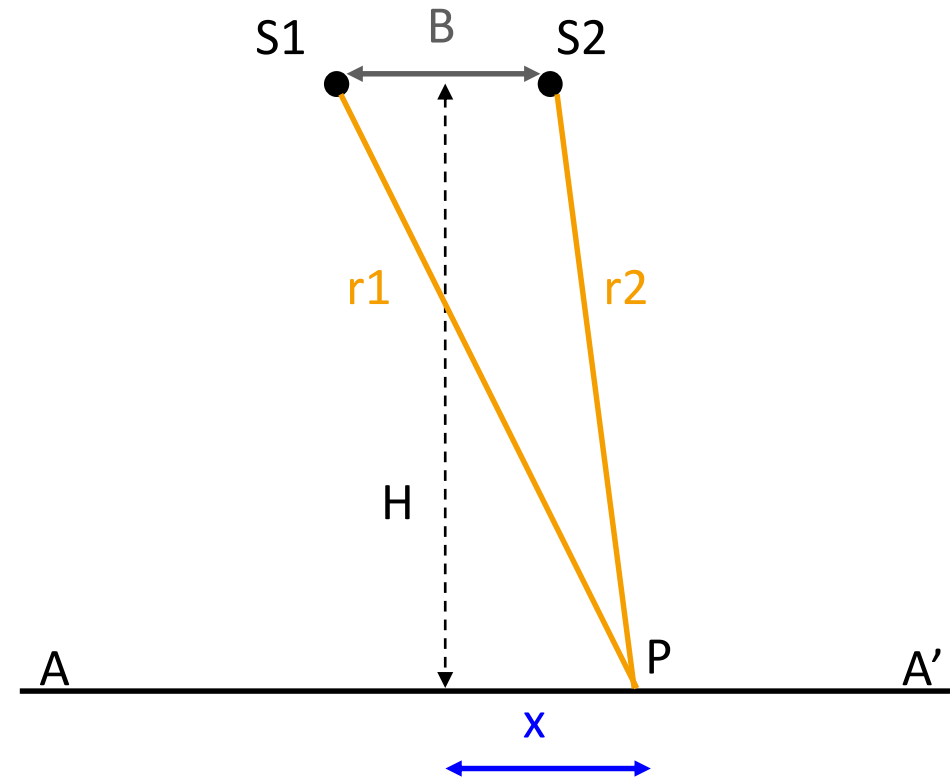

O campo elétrico total no ponto P (com posição x) é dado por

$$E_1(r_1, t) + E_2(r_2, t) = E_{0,1} \cos\left(2\pi\left(\frac{t}{T} - \frac{r_1}{\lambda}\right) + \varphi_1\right) + E_{0,2} \cos\left(2\pi\left(\frac{t}{T} - \frac{r_2}{\lambda}\right) + \varphi_2\right)$$

(sabendo que $\omega=2\pi/T$ e $k=2\pi/\lambda$)

O somatório de duas ondas de amplitude E_0 é dada por:

$$E_1(r_1, t) + E_2(r_2, t) \sim E_0 \left\{ \cos\left(2\pi\left(\frac{t}{T} - \frac{r_1}{\lambda}\right) + \varphi_1\right) + \cos\left(2\pi\left(\frac{t}{T} - \frac{r_2}{\lambda}\right) + \varphi_2\right) \right\}$$

Nestes condições observam-se sobre o ecrã AA' áreas iluminadas e áreas obscuras alternadas (as chamadas franjas de interferência):

$$I_{tot} \approx \frac{E_0^2}{Z_0} + \frac{E_0^2}{Z_0} \cdot \cos\left(\frac{2\pi}{\lambda} \cdot [r_1 - r_2] - [\varphi_1 - \varphi_2]\right)$$

Z_0 - impedancia

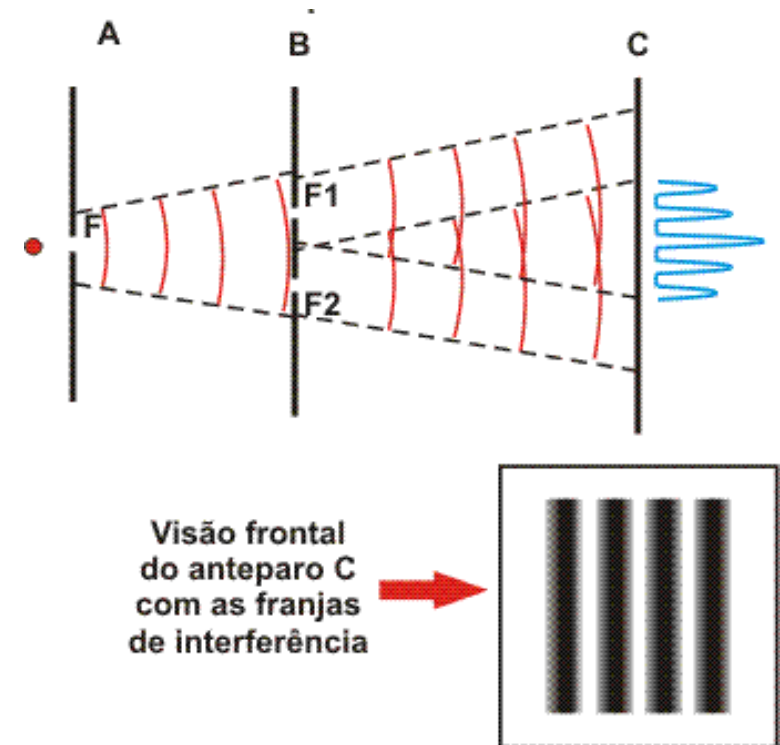

No caso da interferometria radar a interferência é observada ao nível da fase (e não da intensidade) sendo esta dependente da morfologia do terreno ou das suas variações.

Usando a notação complexa para o campo elétrico

$$E_1 = E_0 \cdot e^{i \cdot \left(2\pi \cdot \left[\frac{t}{T} - \frac{r_1}{\lambda} \right] + \phi_1 \right)} \quad E_2 = E_0 \cdot e^{i \cdot \left(2\pi \cdot \left[\frac{t}{T} - \frac{r_2}{\lambda} \right] + \phi_2 \right)}$$

O termo de interferência é dado por

$$E_1 \cdot E_2^* = E_{0,1} \cdot e^{i \cdot \left(2\pi \cdot \left[\frac{t}{T} - \frac{r_1}{\lambda} \right] + \phi_1 \right)} \cdot E_{0,2} \cdot e^{-i \cdot \left(2\pi \cdot \left[\frac{t}{T} - \frac{r_2}{\lambda} \right] + \phi_2 \right)} = |E_0|^2 \cdot e^{i \cdot \left(\frac{2\pi}{\lambda} \cdot [r_2 - r_1] - [\phi_2 - \phi_1] \right)}$$

$$z = r e^{i\theta} = E_1 \cdot E_2^* = |E_0|^2 \cdot e^{i \cdot \left(\frac{2\pi}{\lambda} [r_2 - r_1] - [\phi_2 - \phi_1] \right)}$$

O argumento (ângulo θ) do numero complexo z fornece a informação contida no interferograma SAR.

$$\theta = \frac{2\pi}{\lambda} \cdot [r_2 - r_1] - [\phi_2 - \phi_1]$$



$$\theta = -\frac{2\pi}{\lambda} \cdot [r_1 - r_2]$$

$$\phi_1 - \phi_2 = 0$$

Diferença de fase constante devido à coerência das fontes de radiação electromagnética

No caso da medição se realizar ao nível do sensor então em vez de r estamos a medir a distancia $2r$

$$\theta = -\frac{4\pi}{\lambda} \cdot [r_1 - r_2]$$

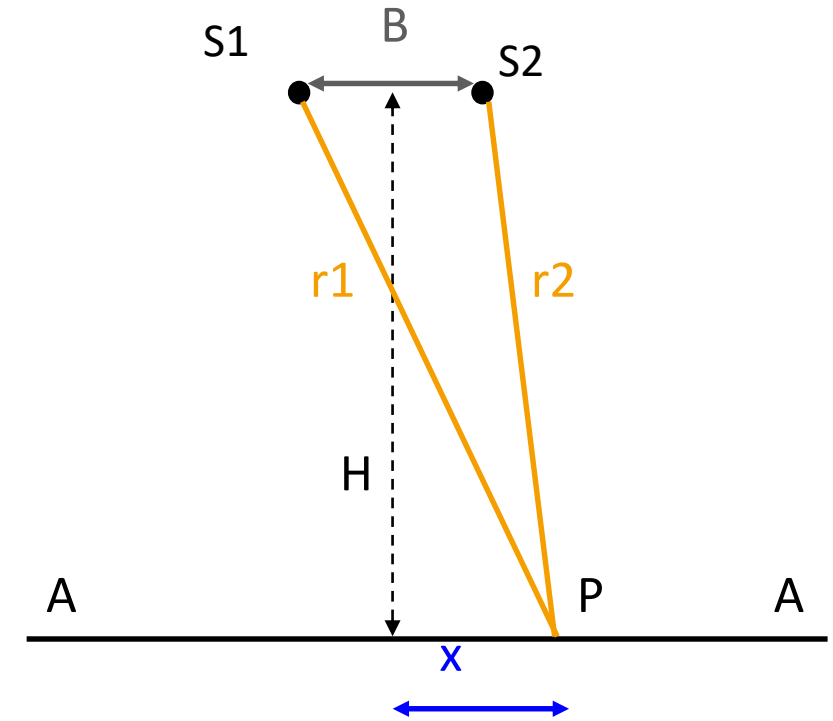

Interferometria SAR

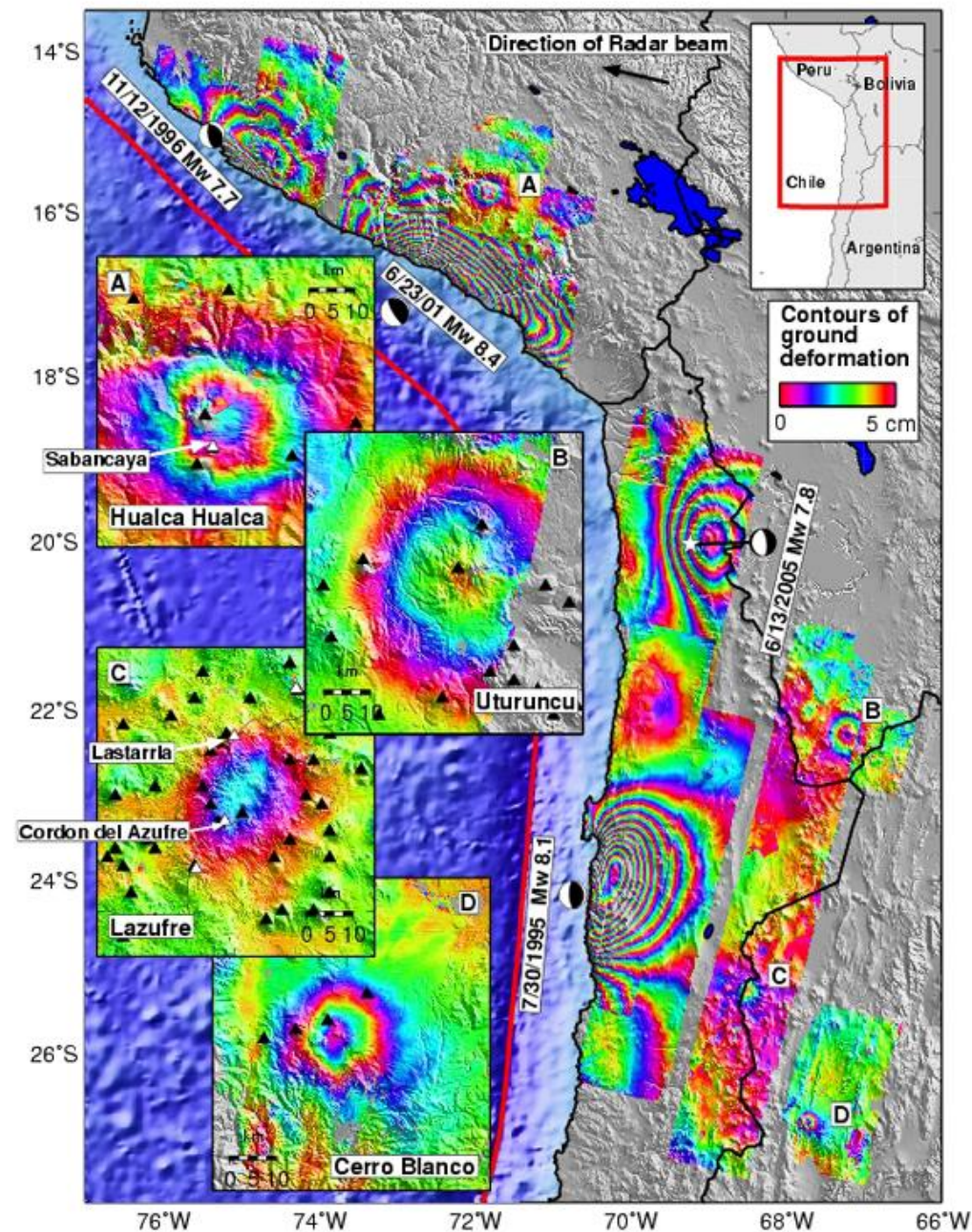
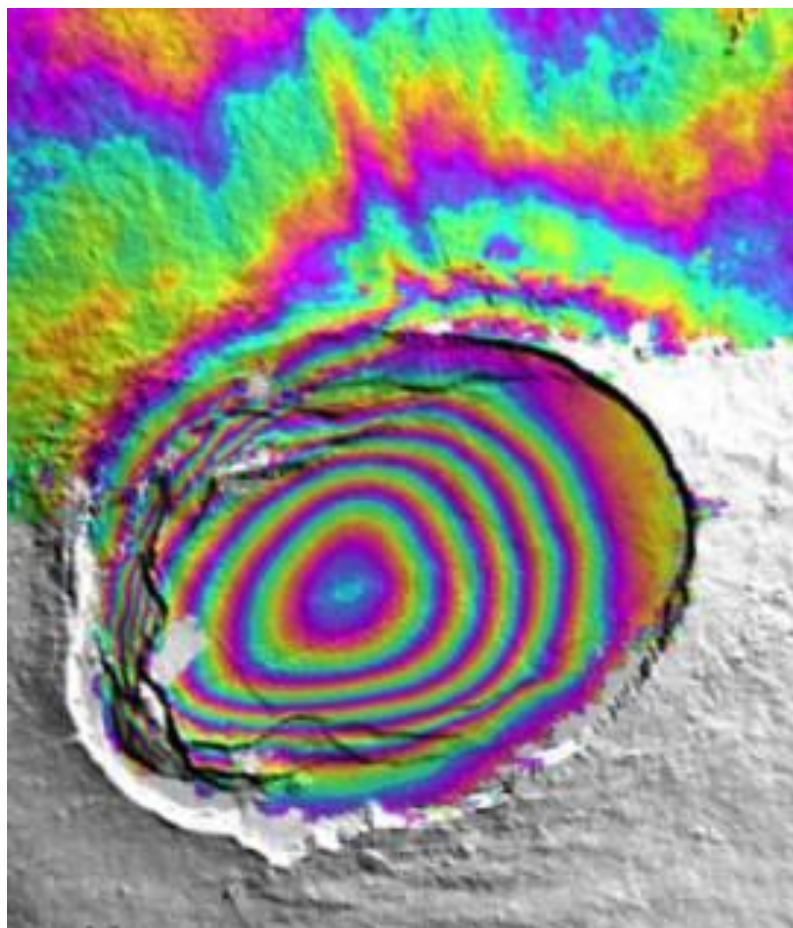



SPOT 5
(optical satellite)

passive



Further Examples:

Non-imaging: radiometer, magnetic sensor

Imaging: cameras, optical mechanical scanner, spectrometer, radiometer



active



TerraSAR-X
(radar satellite)

Further Examples:

Non-imaging: radiometer, altimeter, laser

Imaging: Real Aperture Radar, Synthetic Aperture Radar

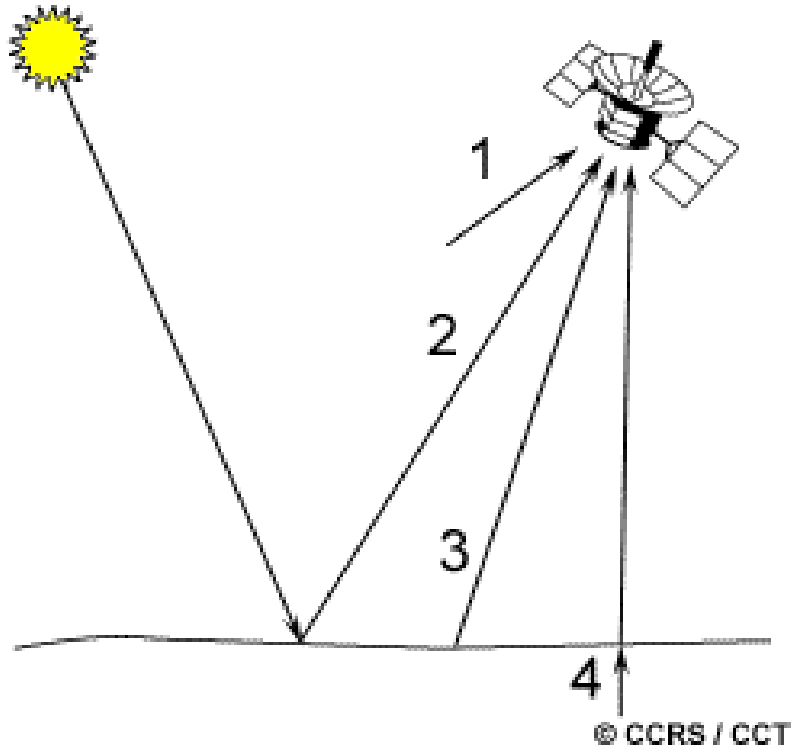

A energia das microondas registada num sensor passivo (radiómetro) pode ser:

1. Emitida pela atmosfera
2. Reflectida pela superfície
3. Emitida pela superfície
4. Transmitida pela superfície

Como o c.o. é “muito grande”, a energia disponível é muito pequena quando comparada com os c.o. ópticos.



Por isso o elemento resolução no terreno deve ser suficientemente grande para que a energia seja suficiente para ser detetada ao nível do satélite. Os sensores passivos microondas (radiómetros) são caracterizados por uma baixa resolução espacial.

Soil Moisture and Ocean Salinity (SMOS)

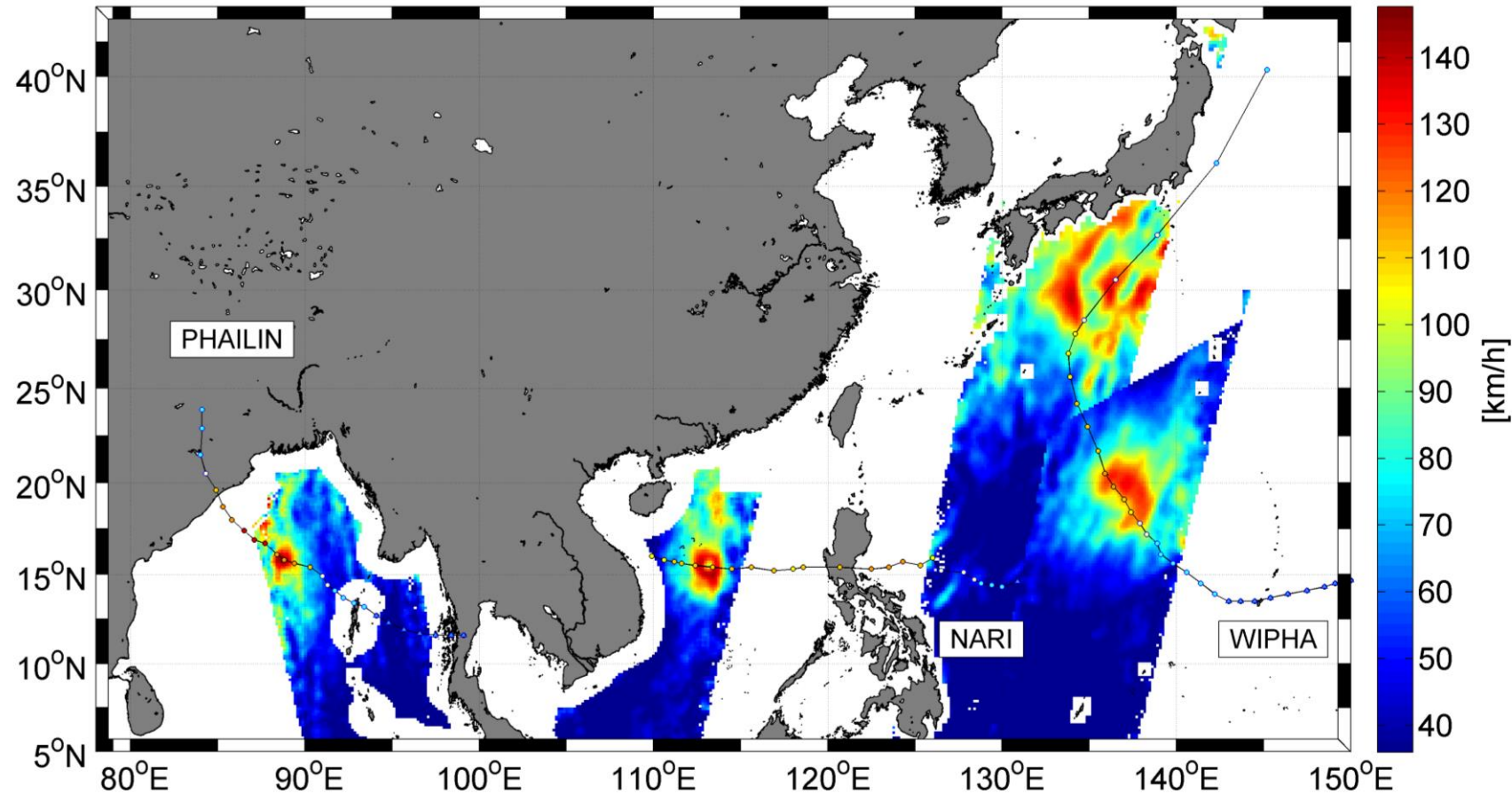

SMOS's microwave radiometer captured wind speed readings from three different typhoons during 10–15 October 2013. The image shows wind speeds up to 140 km/h (dark red) for Cyclone Phailin (left), Typhoon Nari (middle) and Typhoon Wipha (right). Pixel size 43 km

Soil Moisture map of Europe - November 2011

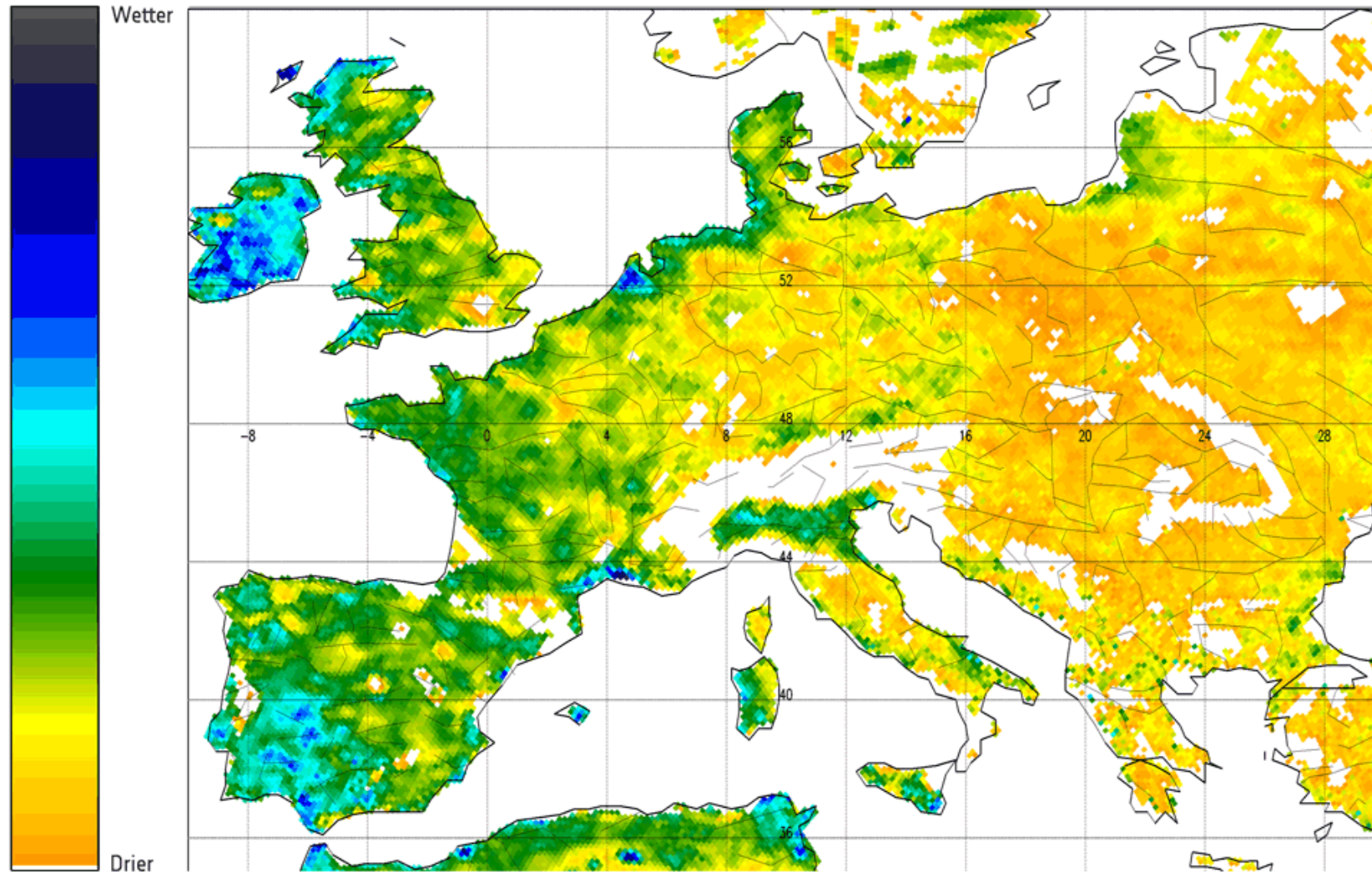

RADAR is an active sensor, transmitting its own energy, and then measuring the return scattered by the earth's surface back to the satellite's antenna.

The data for a RADAR image is collected by a satellite with a side looking antenna, which transmits a stream of radar pulses and records the backscattered signal corresponding to each pulse.

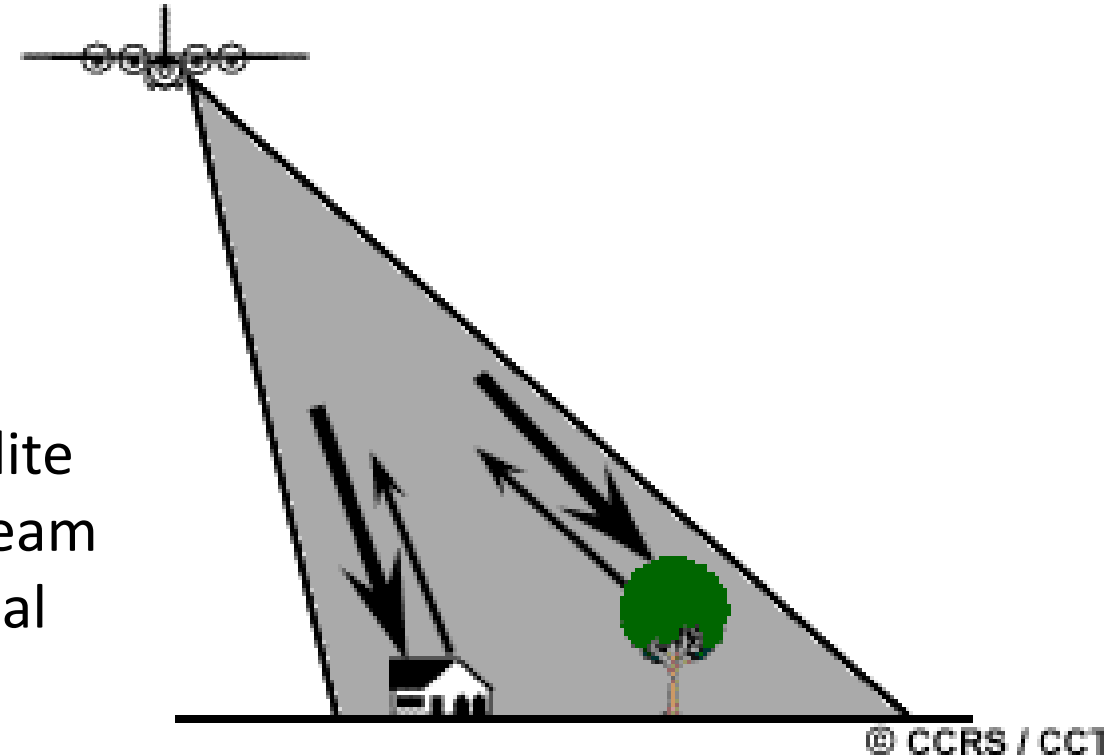

RADAR (Radio Dectection And Ranging)

Formação das imagens RADAR

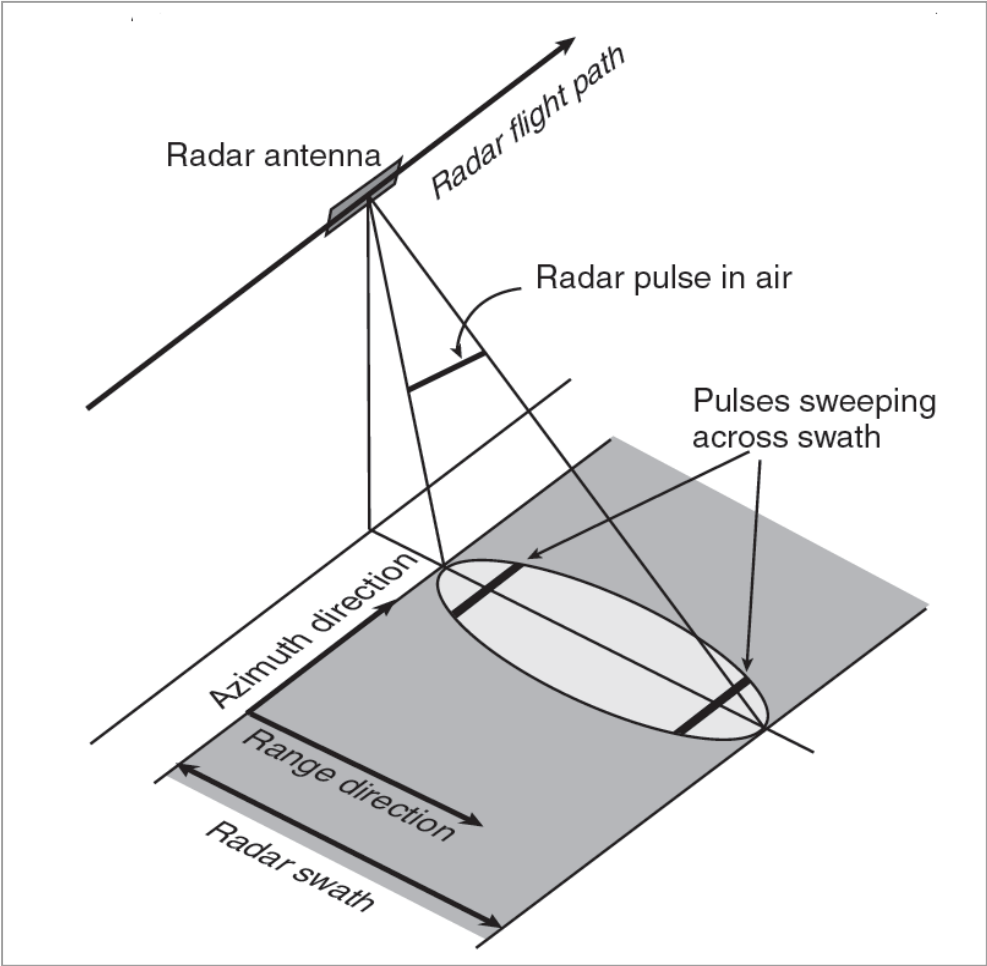
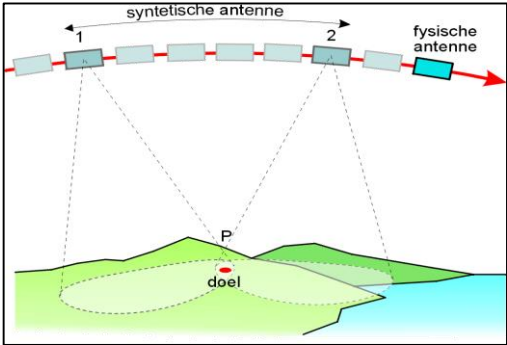
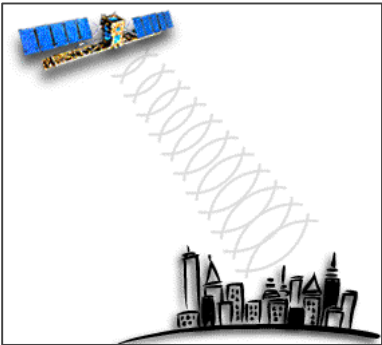
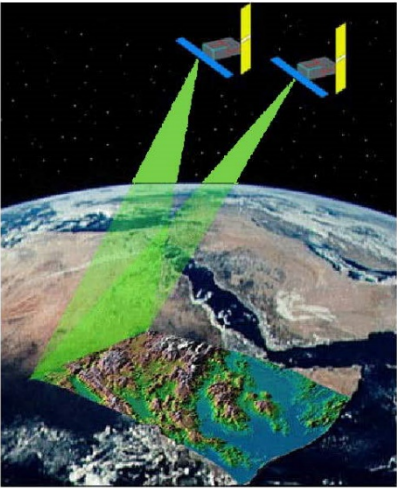
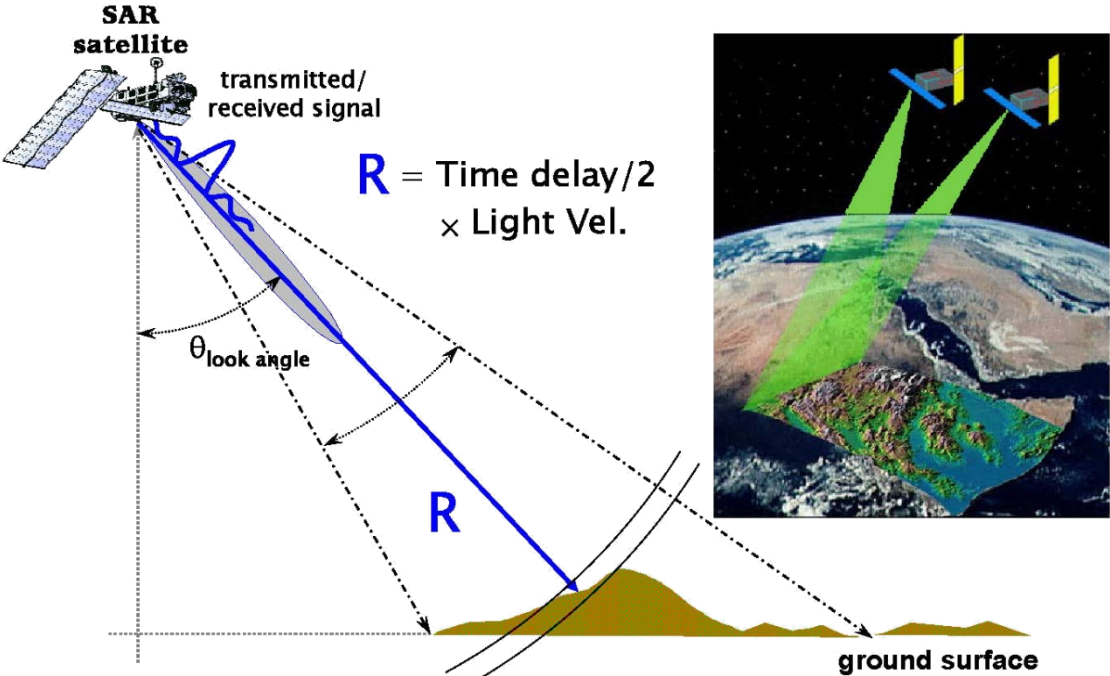

Radar Principle

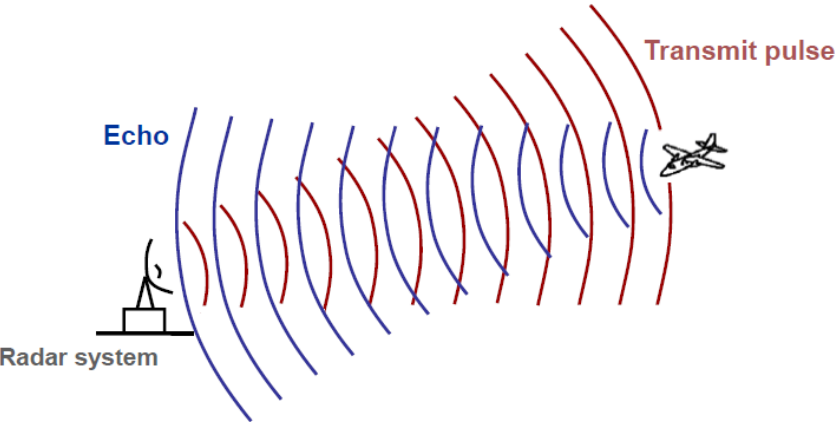

Radar Measurement Principle

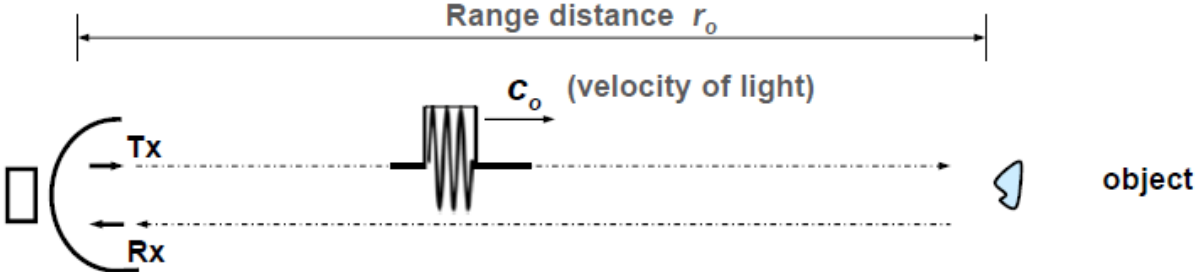

• Received echo signal (back-scattered signal of imaged object):

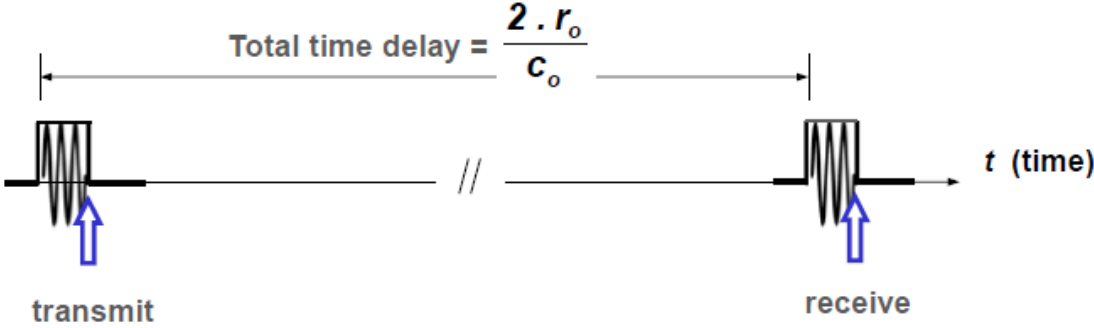

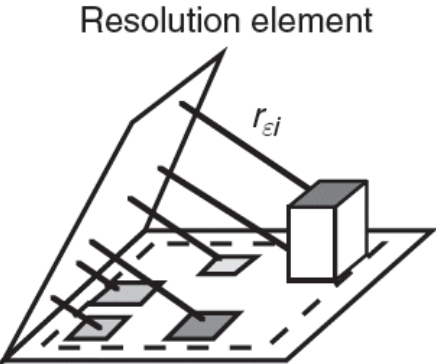
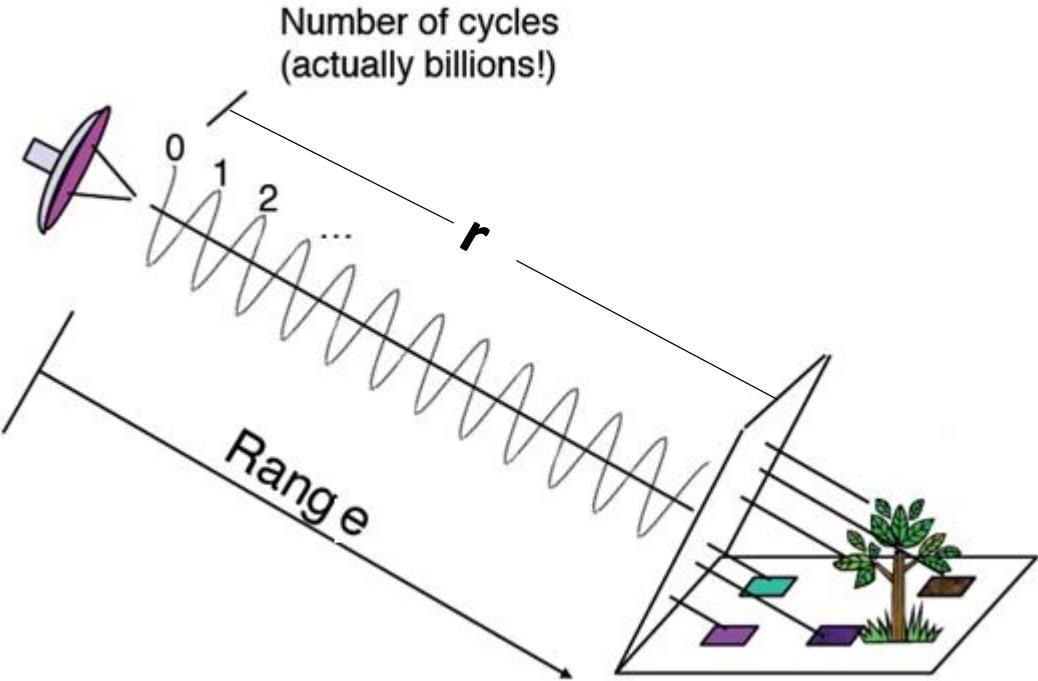

$$\sum_i A_{ei} e^{j\phi_{ei}} e^{-j(4\pi/\lambda)r_{ei}}$$

Contribuição individual

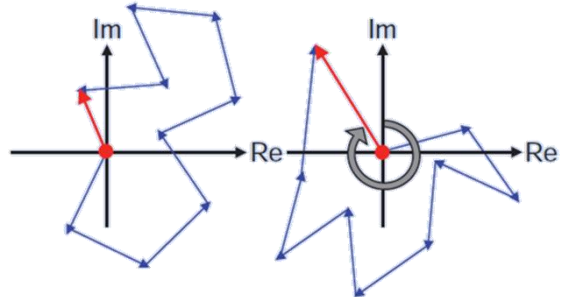

$$s_1 = A_B \cdot e^{(j\phi_B)} \cdot e^{-j\left(\frac{4\pi}{\lambda}\right) \cdot r}$$

Backscattered phase do elemento

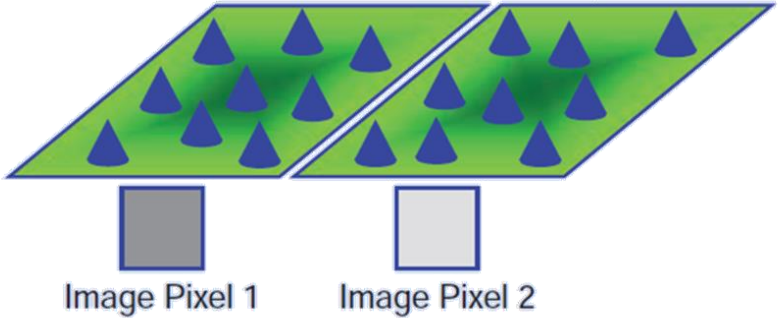



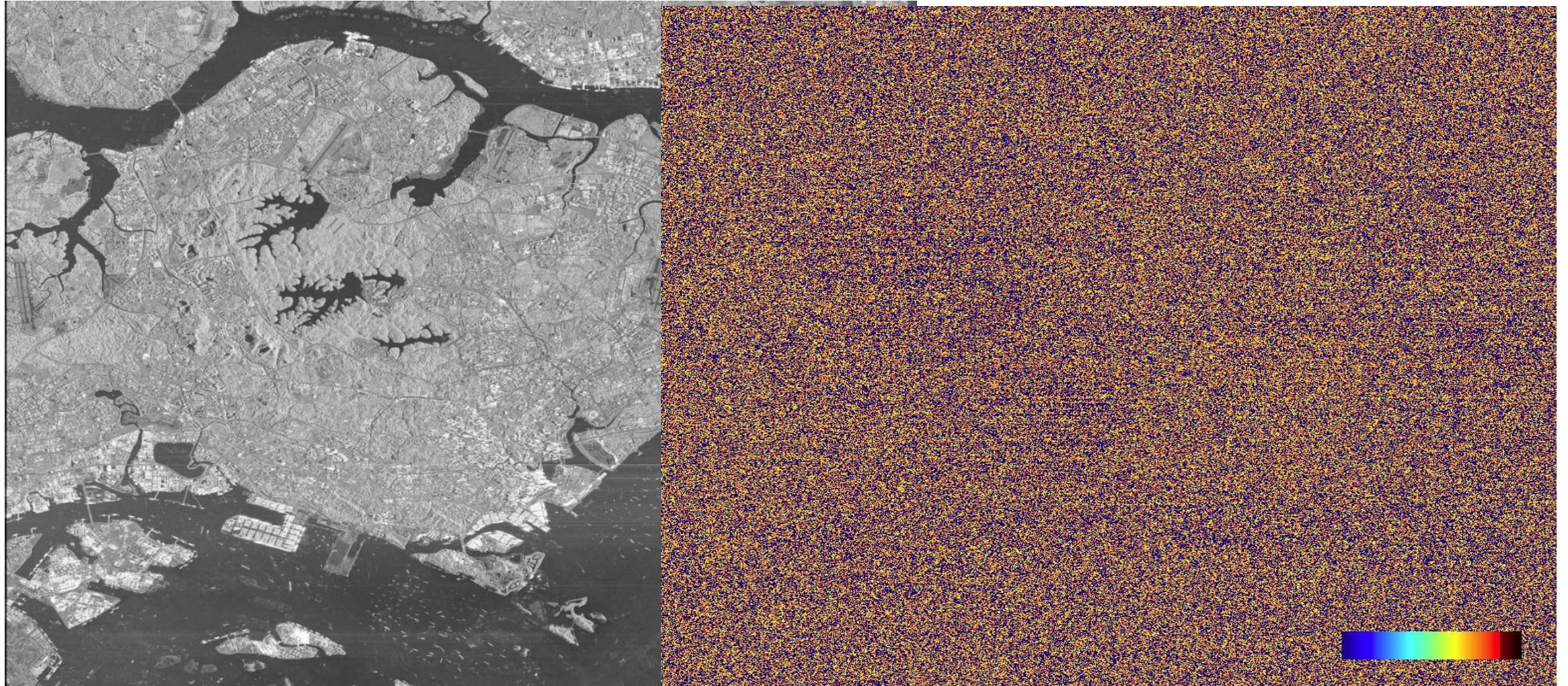

Advantages compared to optical remote sensing

- all weather capability (small sensitivity of clouds, light rain)
- day and night operation (independence of sun illumination)
- no effects of atmospheric constituents (multitemporal analysis)
- sensitivity to dielectric properties (water content , biomass, ice)
- sensitivity to surface roughness (ocean wind speed)
- accurate measurements of distance (interferometry)
- sensitivity to man made objects
- sensitivity to target structure (use of polarimetry)
- subsurface penetration

Inconvenients

- complex interactions (difficulty in understanding, complex processing)
- speckle effects (difficulty in visual interpretation)
- topographic effects
- effect of surface roughness

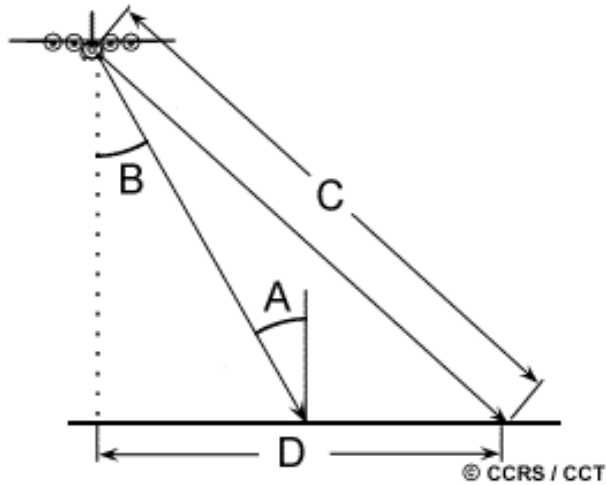

Ângulo Incidente (A)

Ângulo entre o feixe radar e a superfície do terreno. Aumenta na direção do "range" (incidence angle).

Ângulo de vista (B)

É o ângulo de iluminação da superfície (view angle).

Slant Range(C)

(distância inclinada)

A distância entre o sensor e o alvo na superfície medida ao longo da linha de vista (Line Of Sight, LOS)

Ground Range(D)

Distância projectada no terreno a partir da "slant" range

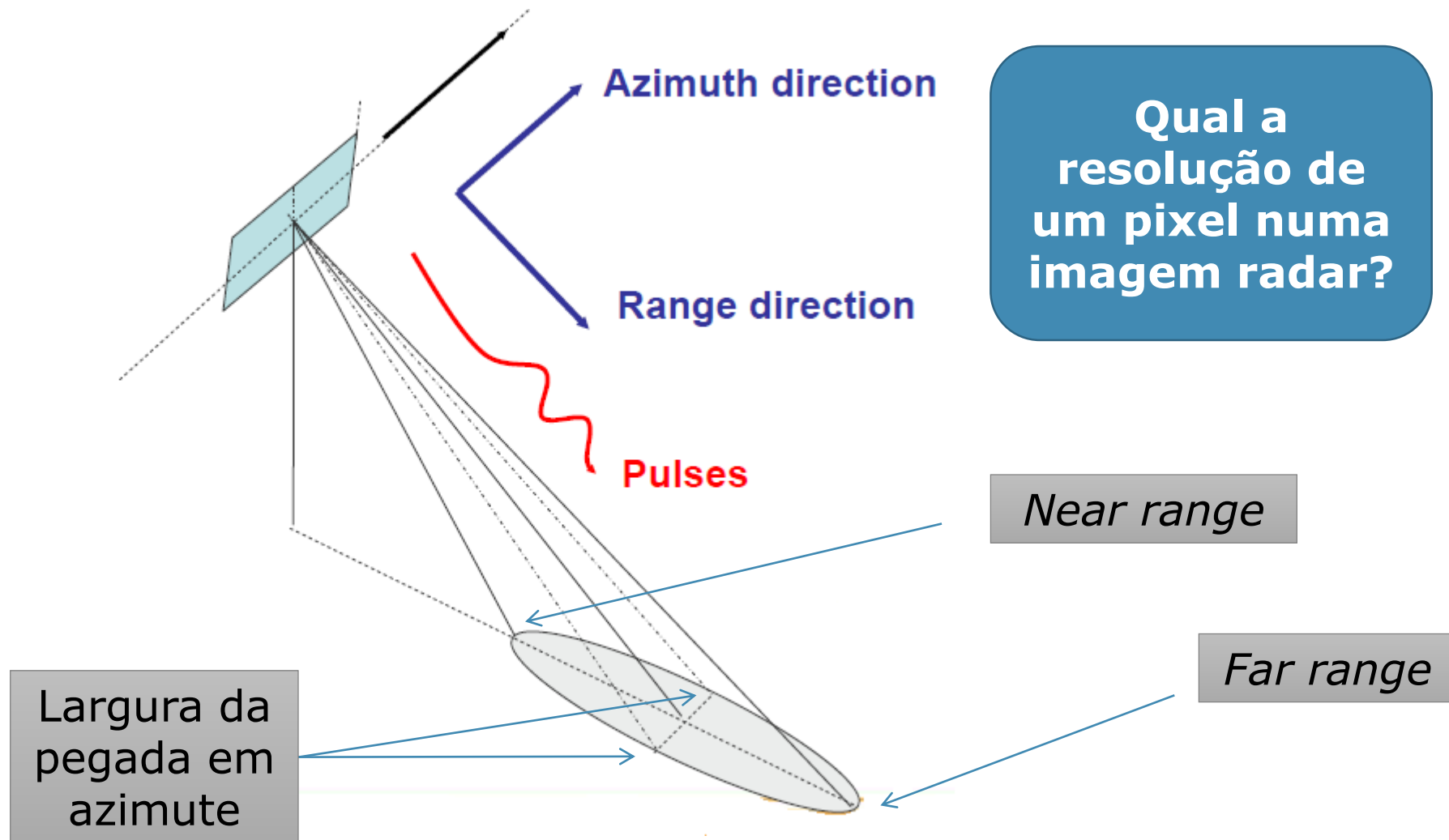

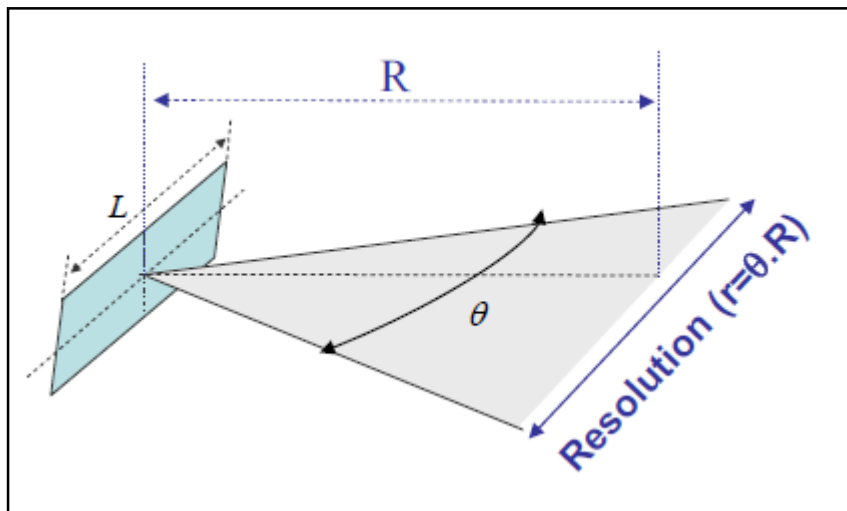

Para uma antena de largura L

Abertura angular

Comprimento de onda

$$\theta = \frac{\lambda}{L}$$

Largura da antena

$$r = \frac{\lambda R}{L}$$



Quanto maior a antena mais fina é a resolução

Exemplo:

Para uma antena de 10m e c.o. de 5 cm (banda C) a resolução em azimute é de **5 km**

$$r = \frac{\lambda R}{L}$$

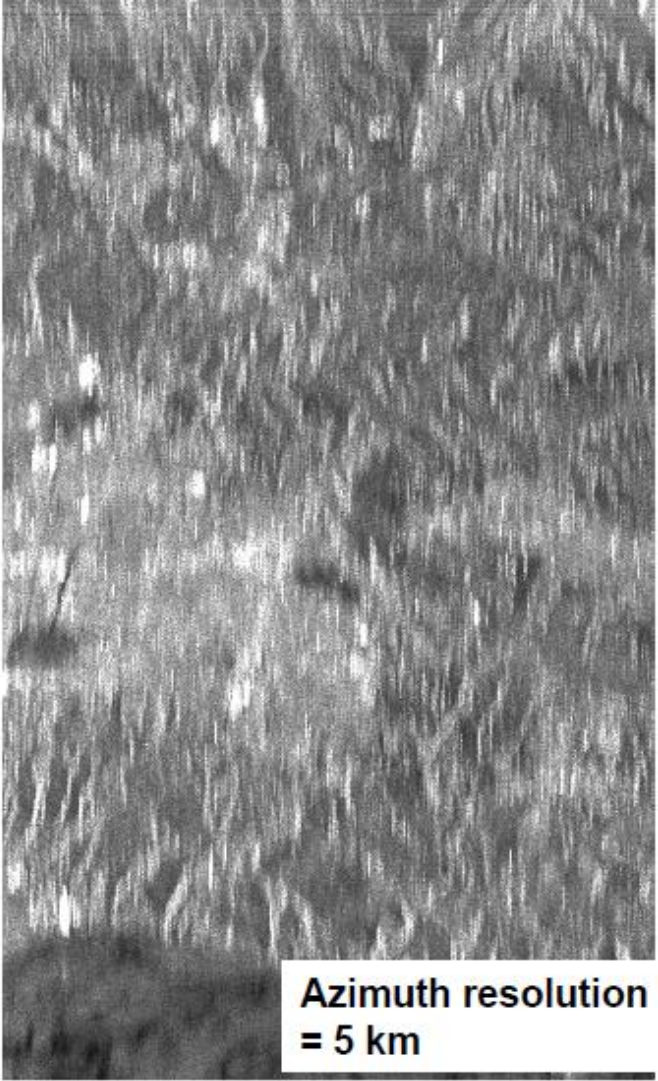
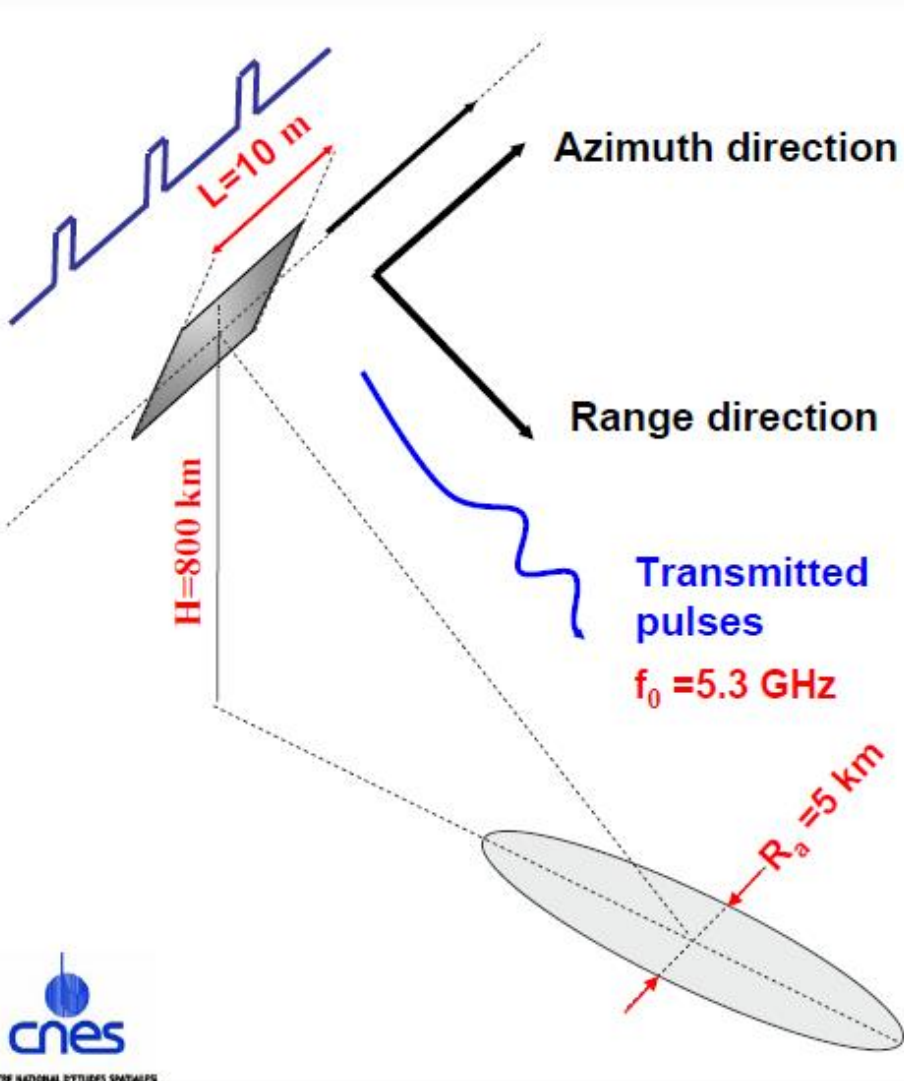

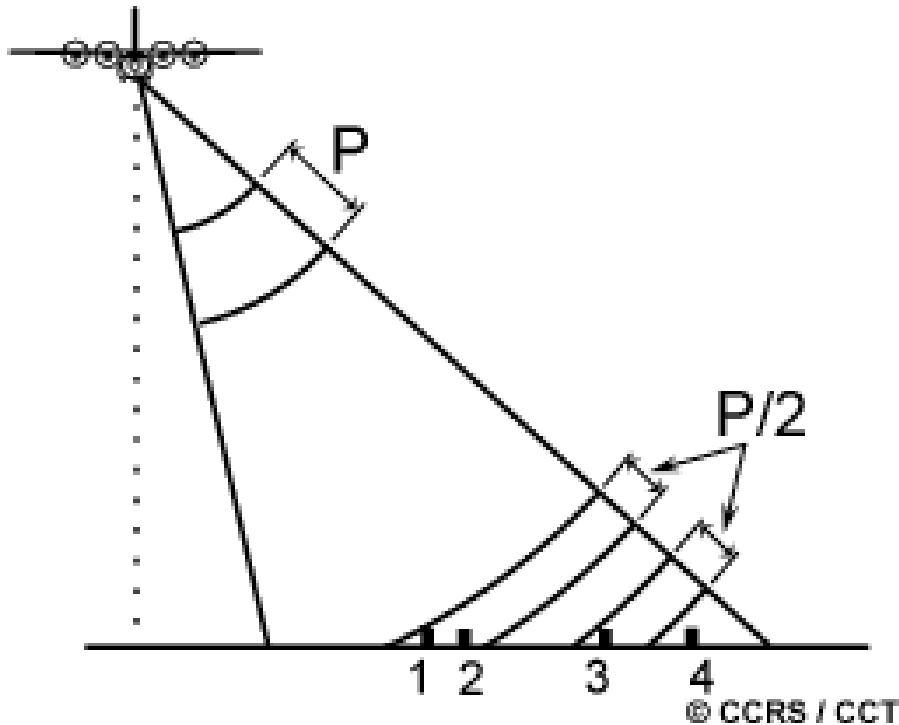

A resolução em range é dependente do comprimento do pulso (P) na direção do “slant range”.



Dois alvos são separáveis se a sua separação é superior metade do comprimento do pulso

$$\Delta r = \frac{c P}{2} \quad \text{Resolução slant range}$$

A resolução em “slant range” é constante (e independente da altitude do voo) enquanto que a resolução na “ground range” é variável e dependente do ângulo de incidência. Objectos 1 e 2 não são separáveis, mas os objectos 3 e 4 são.

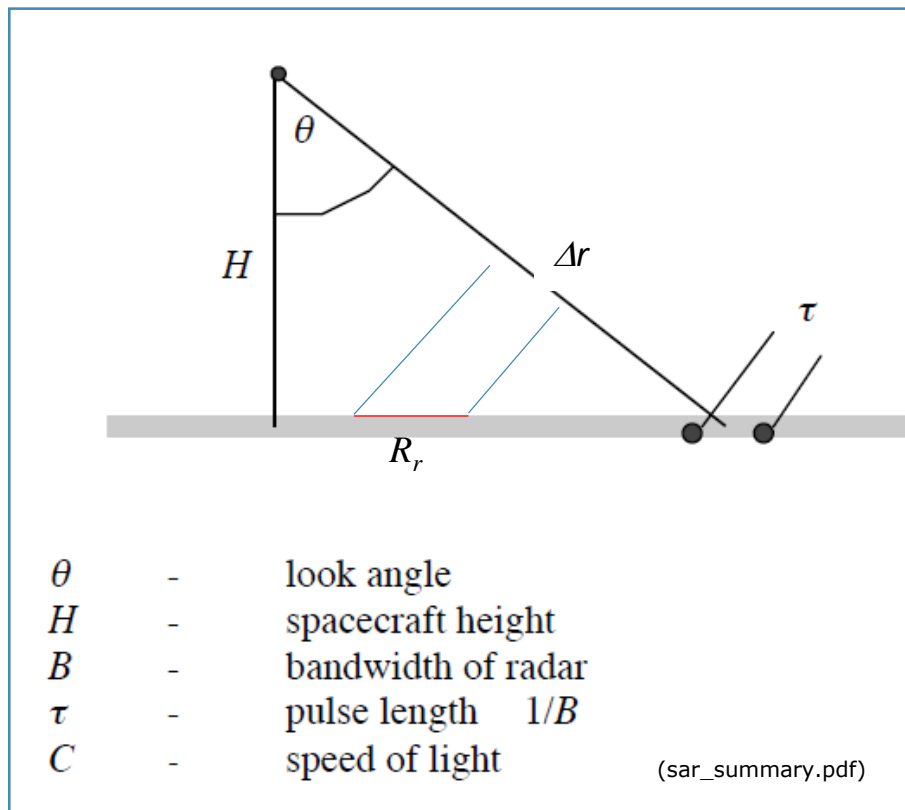

$$\Delta r = \frac{C\tau}{2} \quad - \text{ slant range resolution}$$

$$R_r = \frac{C\tau}{2} \frac{1}{\sin\theta} \quad - \text{ ground range resolution}$$

ERS: Band width 15.5 MHz
 Slant Range resolution = 9.6 m
 Ground range resolution = 24.7 m

TRX: Band width 150 MHz
 Slant Range resolution = 1.0 m
 Ground range resolution = 2.9m

ERS
 Azimuth = 5 km
 Range = 25 m

PRF = 1.640 – 1.720 kHz

TRX
 Azimuth = 4.4 km
 Range = 3 m

PRF = 2.0 – 6.5 kHz

Resolução em Range

Pode ser aumentada usando pulsos com menor comprimento, o que pode ser conseguido dentro de certos limites da engenharia.

Resolução em Azimute

Pode ser conseguida aumentando o tamanho da antena.

Contudo o tamanho das antenas é limitado a 10 ou 15 metros.

Criação de uma antena sintética : Synthetic Aperture Radar (SAR)

(proposto por Wiley, 1954 e demonstrado por Graham em 1974)

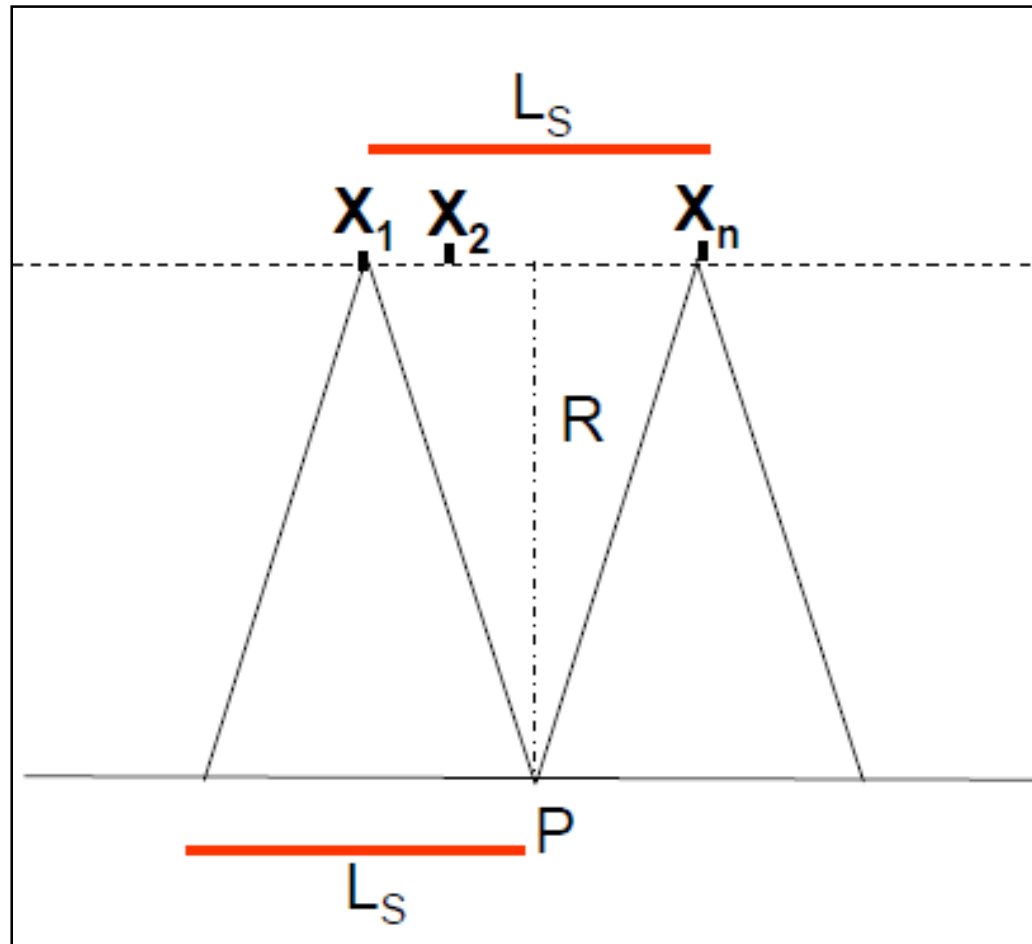

Os ecos obtidos das posições $X_1, X_2 \dots X_n$ são registados coerentemente (amplitude e fase) em função do tempo.

A distância entre a primeira posição registada e a última determina a abertura sintética da antena L_s .

Este método é designado por:

Synthetic Aperture Radar

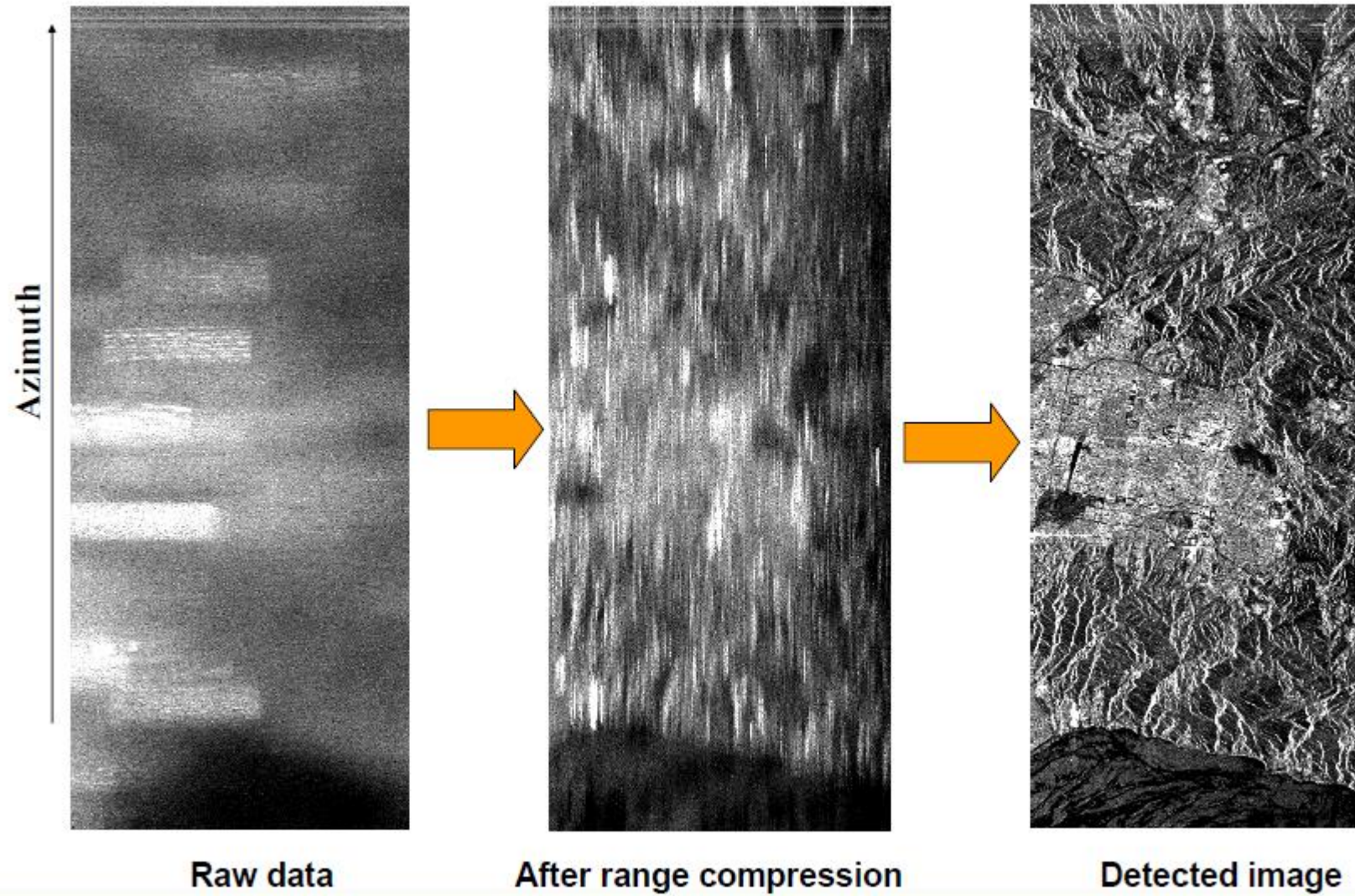

Causas da distorção nas imagens SAR:

facto de haver apenas a medição de uma distância

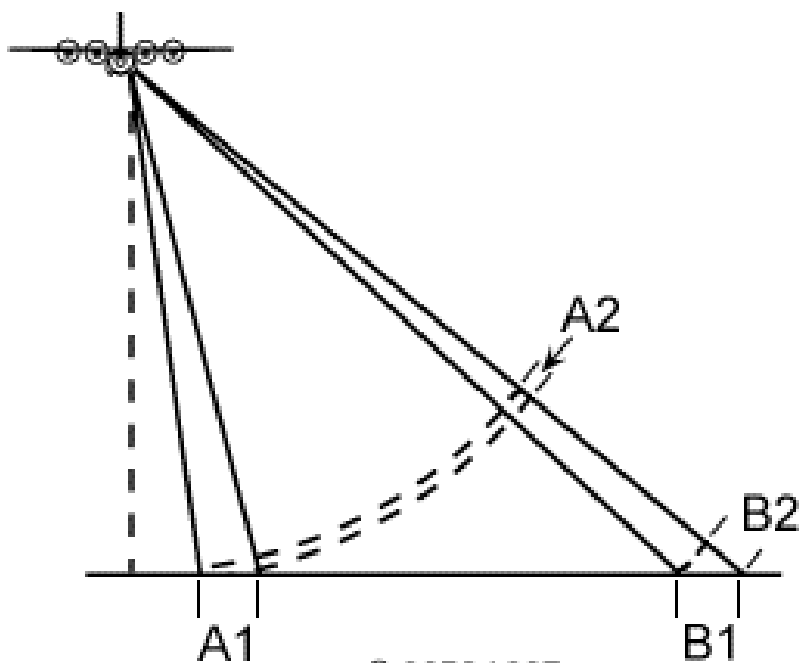

© CCRS / CCT

à geometria de aquisição com uma visada lateral,

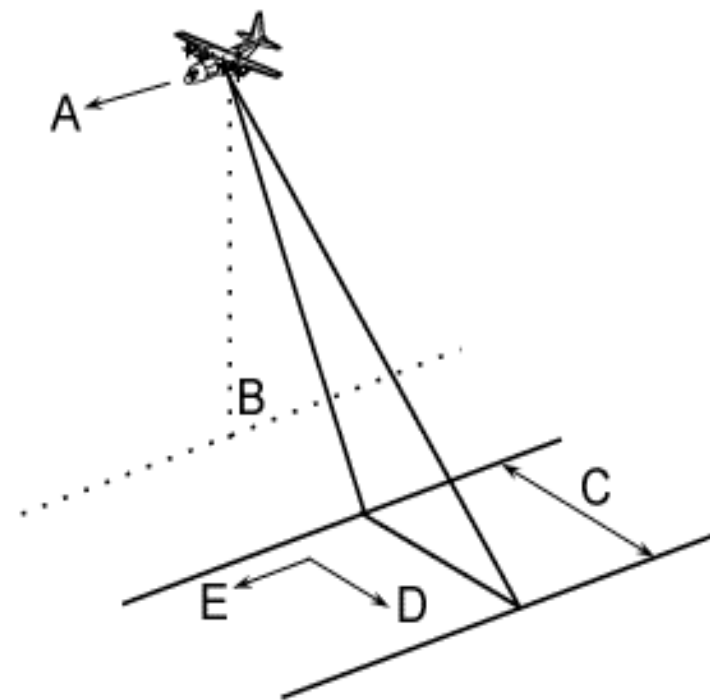

A distorções devidas ao relevo são unidimensionais e ocorrem perpendicularmente à linha de voo.

Foreshortening

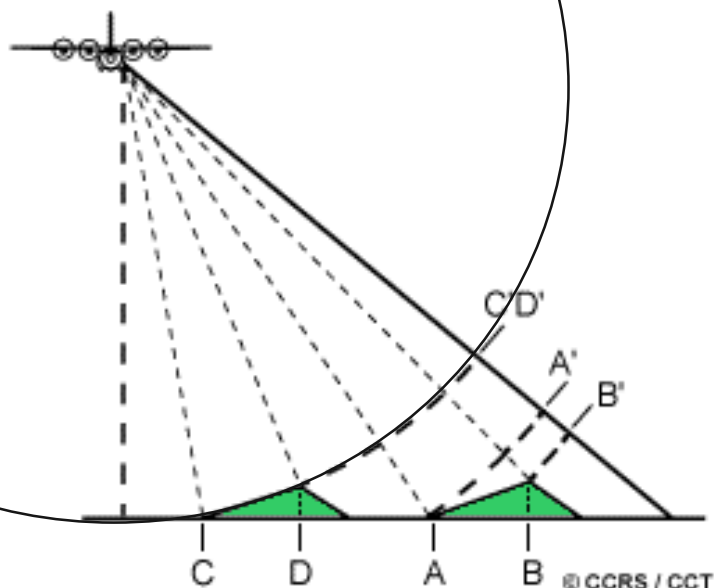

Layover

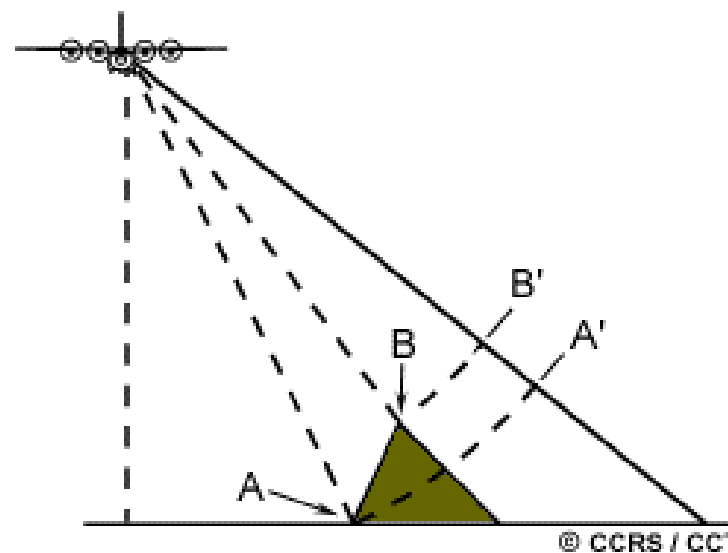

© CCRS / CCT

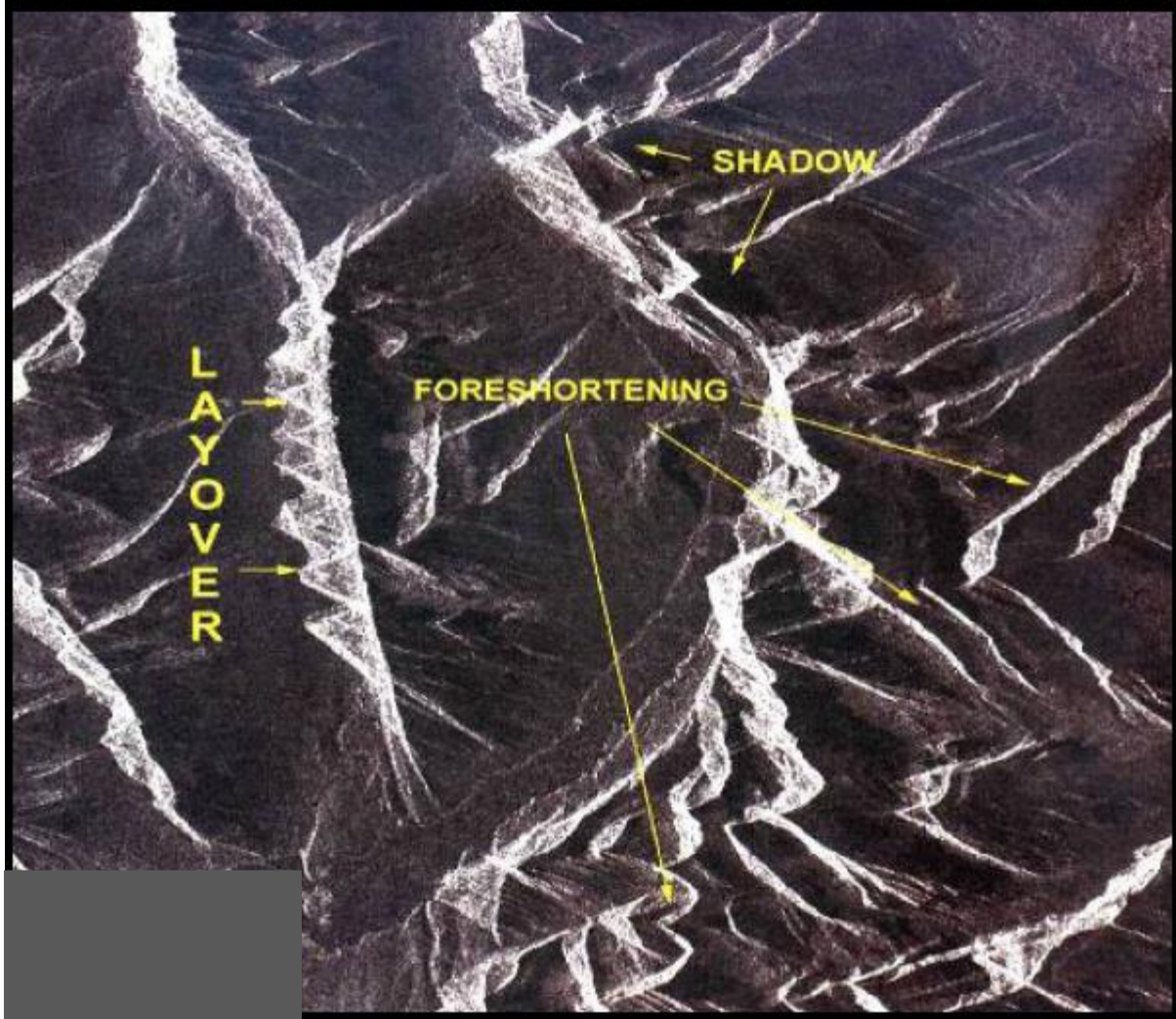
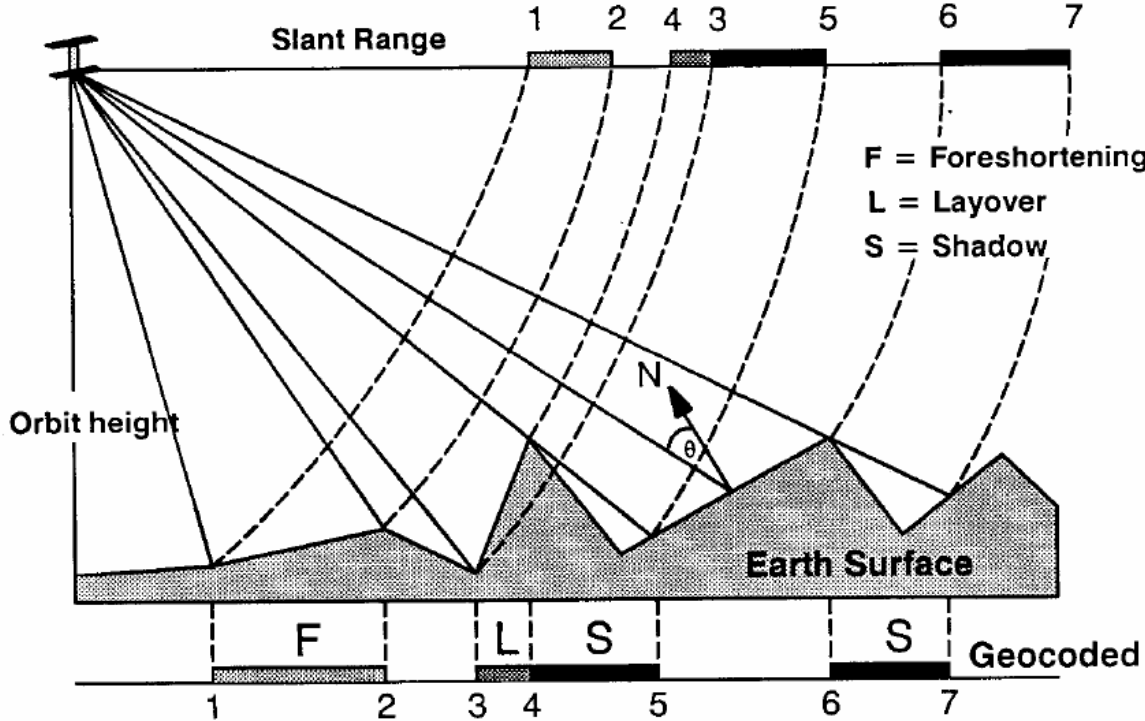

Distorção devida ao relevo

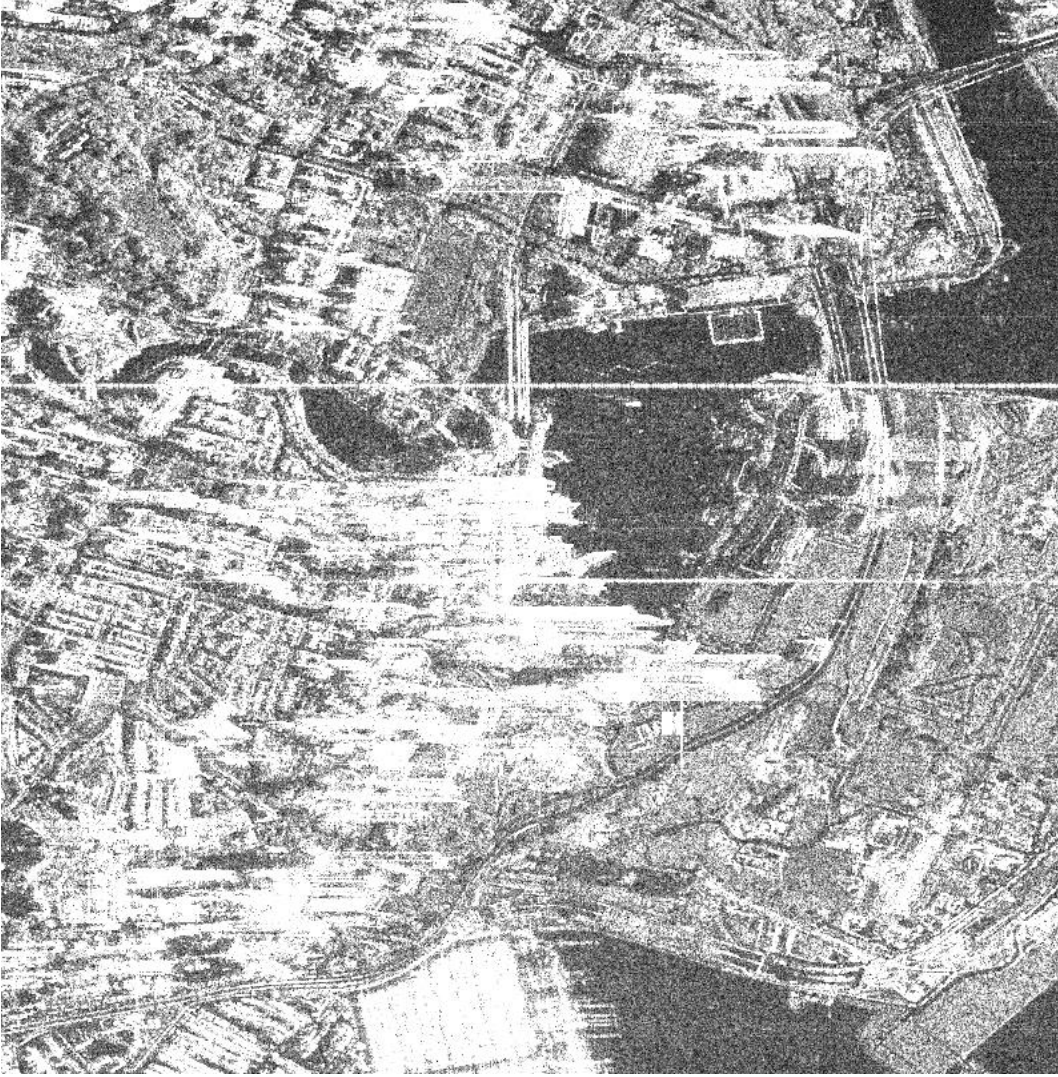
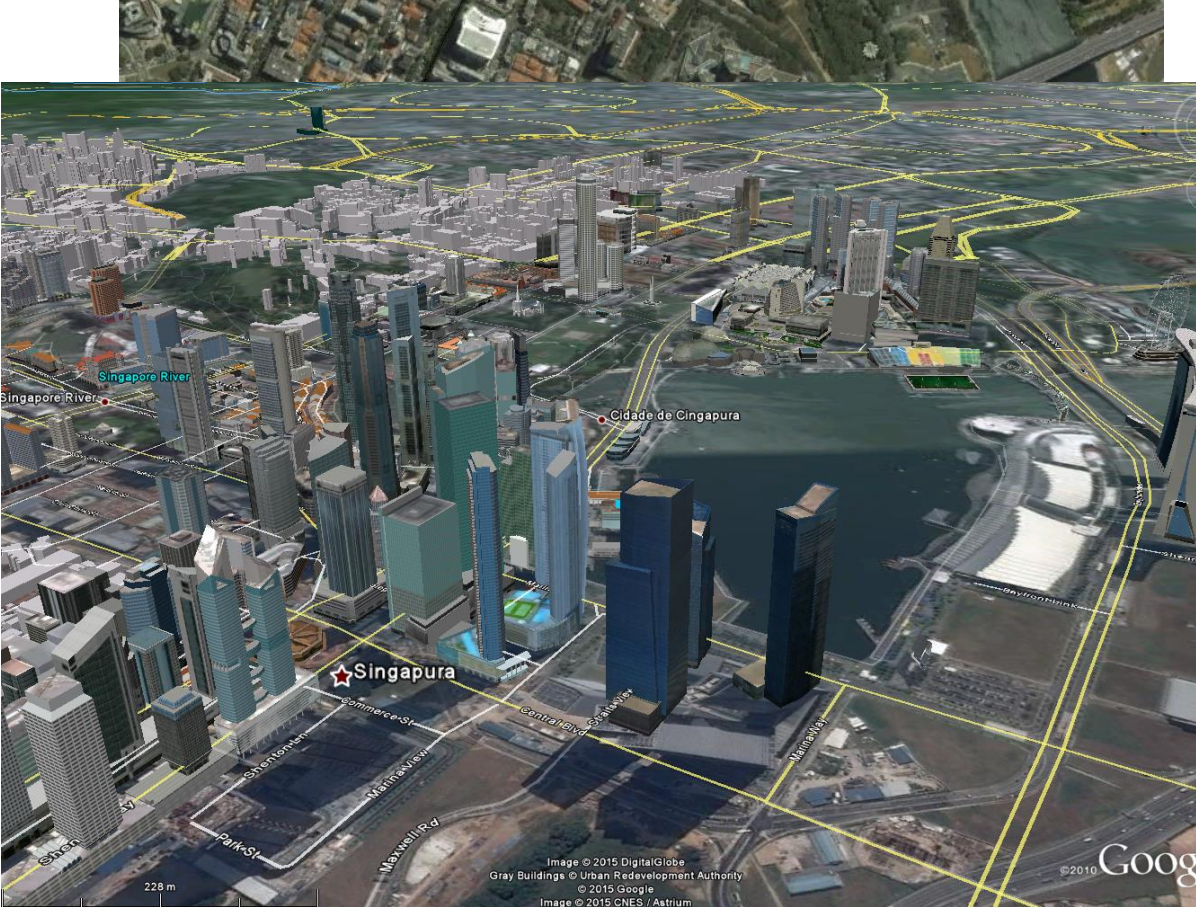

What does the Radar measure ?

- *Radar reflectivity (backscattered signal) of targets as a function of their position*

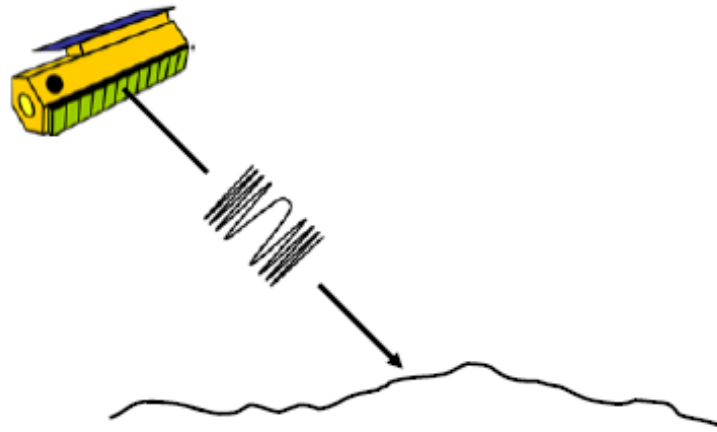

- radar transmits a pulse
(travelling velocity is equal to velocity of light)

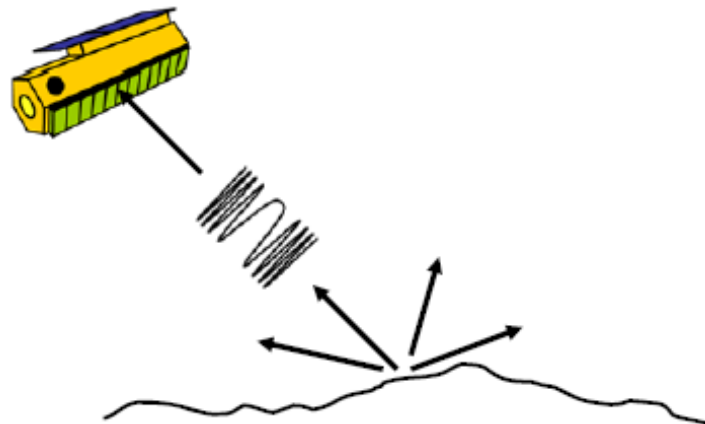

- some of the energy in the radar pulse is reflected back towards the radar.
This is what the radar measures.
It is known as radar backscatter σ_0
(sigma nought or sigma zero).

What does the Radar measure ?

- Normalized radar cross-section (backscattering coefficient) is given by:

$$\sigma_o \text{ (dB)} = 10 \cdot \text{Log}_{10} \text{ (energy ratio)}$$

whereby

$$\text{energy ratio} = \frac{\text{received energy by the sensor}}{\text{“energy reflected in an isotropic way”}}$$

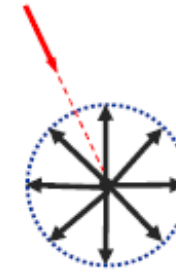

Isotropic scatterer

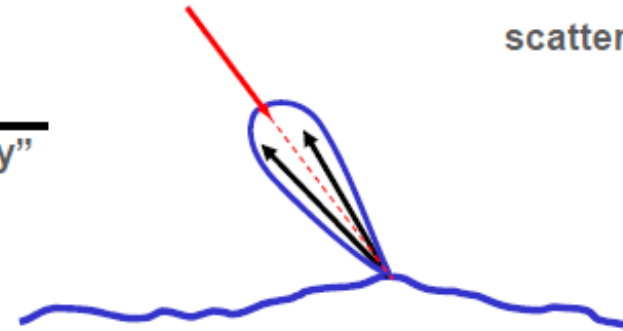

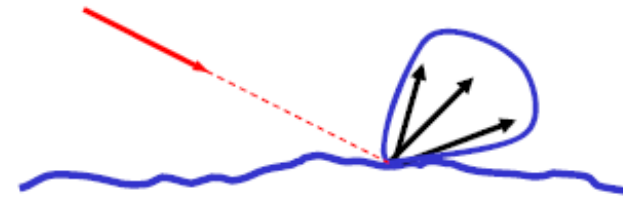

The backscattered coefficient can be a positive number if there is a focusing of backscattered energy towards the radar

or



The backscattered coefficient can be a negative number if there is a focusing of backscattered energy way from the radar (e.g. smooth surface)

Backscattering Coefficient σ_0

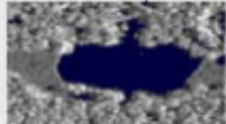
<i>Levels of Radar backscatter</i>		<i>Typical scenario</i>
<ul style="list-style-type: none">• <i>Very high backscatter (above -5 dB)</i>		<i>Man-Made objects (urban) Terrain Slopes towards radar very rough surface radar looking very steep</i>
<ul style="list-style-type: none">• <i>High backscatter (-10 dB to 0 dB)</i>		<i>rough surface dense vegetation (forest)</i>
<ul style="list-style-type: none">• <i>Moderate backscatter (-20 to -10 dB)</i>		<i>medium level of vegetation agricultural crops moderately rough surfaces</i>
<ul style="list-style-type: none">• <i>Low backscatter (below -20 dB)</i>		<i>smooth surface calm water, road very dry terrain (sand)</i>

O sinal transmitido tem as seguintes características:

- **Amplitude**
- **Fase e referencia temporal**
- **Polarização**
- **Comprimento de onda ou frequência**

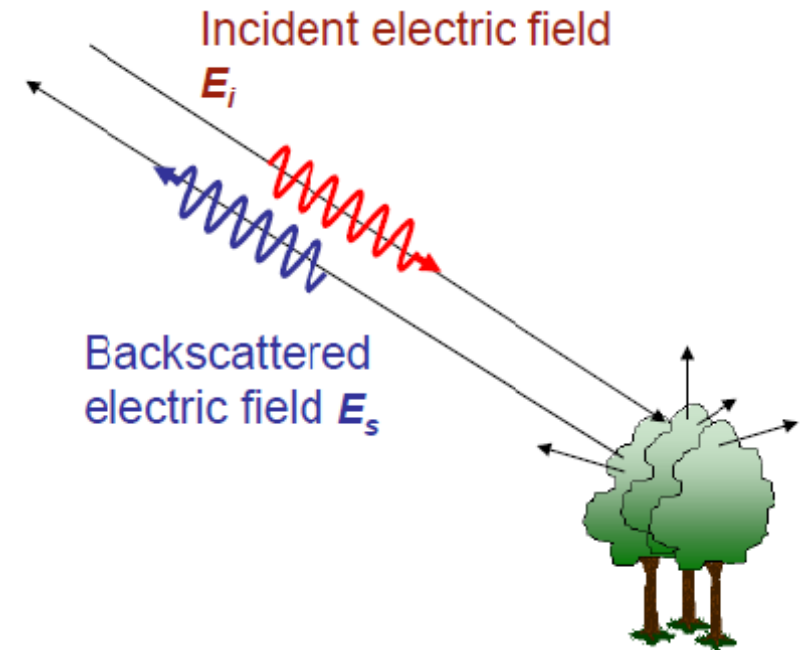

A comparação das características do sinal recebido com sinal transmitido permite determinar as propriedades dos objetos.

O sinal retro-disperso resulta de:

Surface scattering

Volume scattering

A importância relativa destas contribuições depende da:

(Surface
Roughness)

**Rugosidade da
superfície**

**Propriedades dieléctricas
do meio**

Todos estes factores dependem de:

Frequência do radar

Ângulo de incidência

Polarização

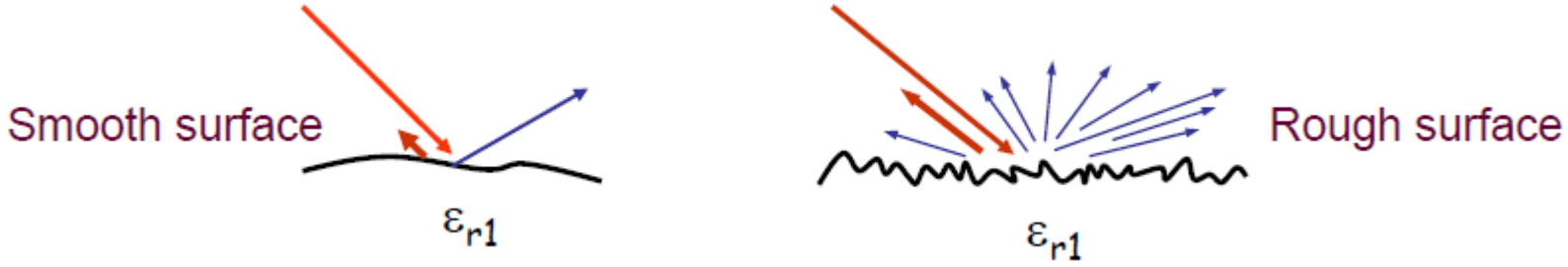

Smooth surface ϵ_{r1} Rough surface ϵ_{r1}

A rugosidade da superfície (relativamente ao comprimento de onda) condiciona o padrão da dispersão.

$\epsilon_{r2} > \epsilon_{r1}$ medium 2 is wetter than medium 1

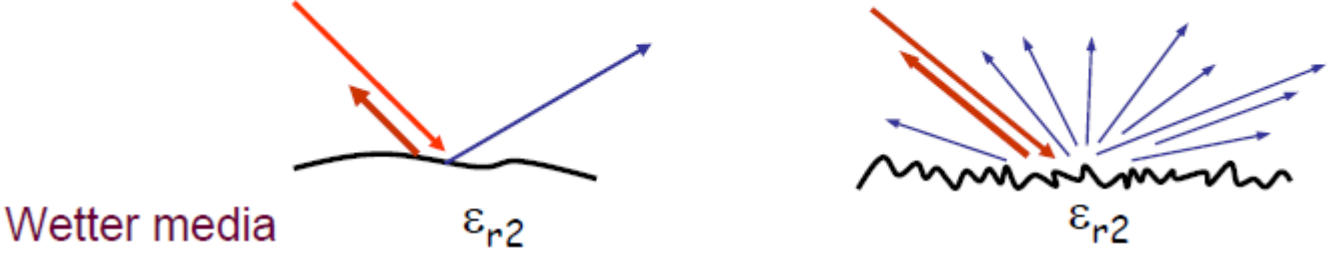

Wetter media ϵ_{r2} ϵ_{r2}

A constante dielétrica (humidade do solo) condiciona a intensidade do sinal retro-disperso.

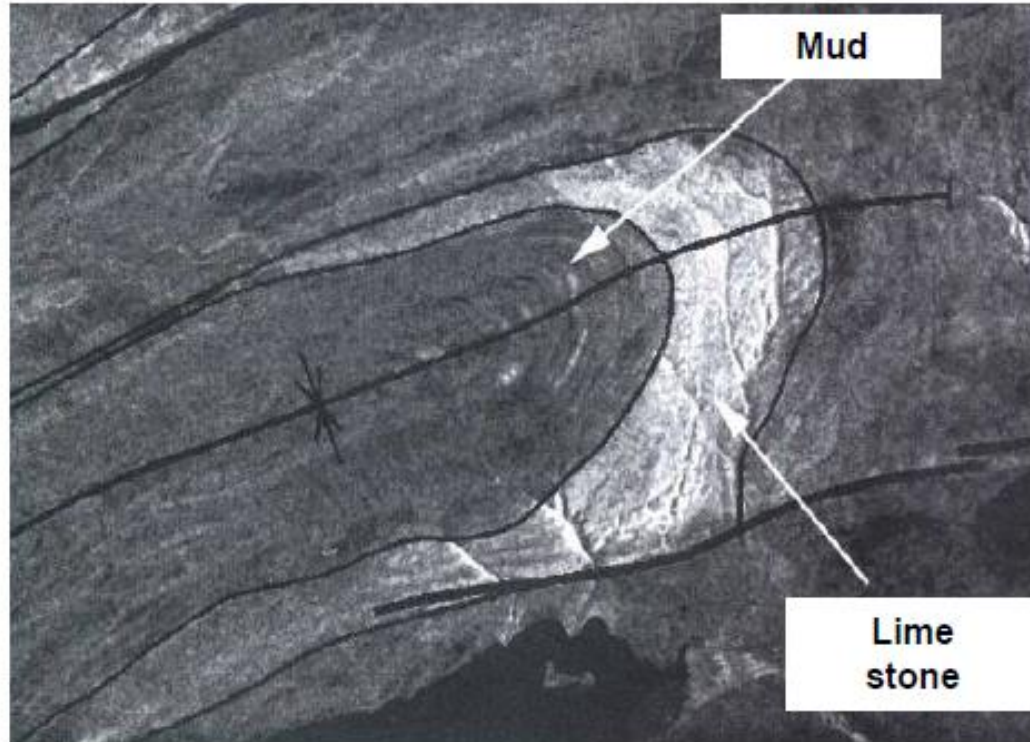

RADARSAT
(C band, HH, 45°)

Quaternary lithology:
Bathurst Island, Canada

From : RADARSAT Geology Handbook



Mud fragments (smooth surface)
➡ low radar backscatter
(marga/argila)

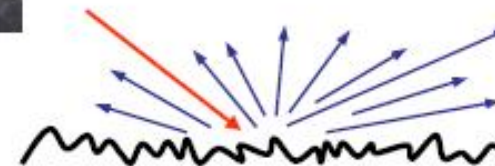

Limestone ➡ Higher backscatter
because of rougher surface
(calcário)

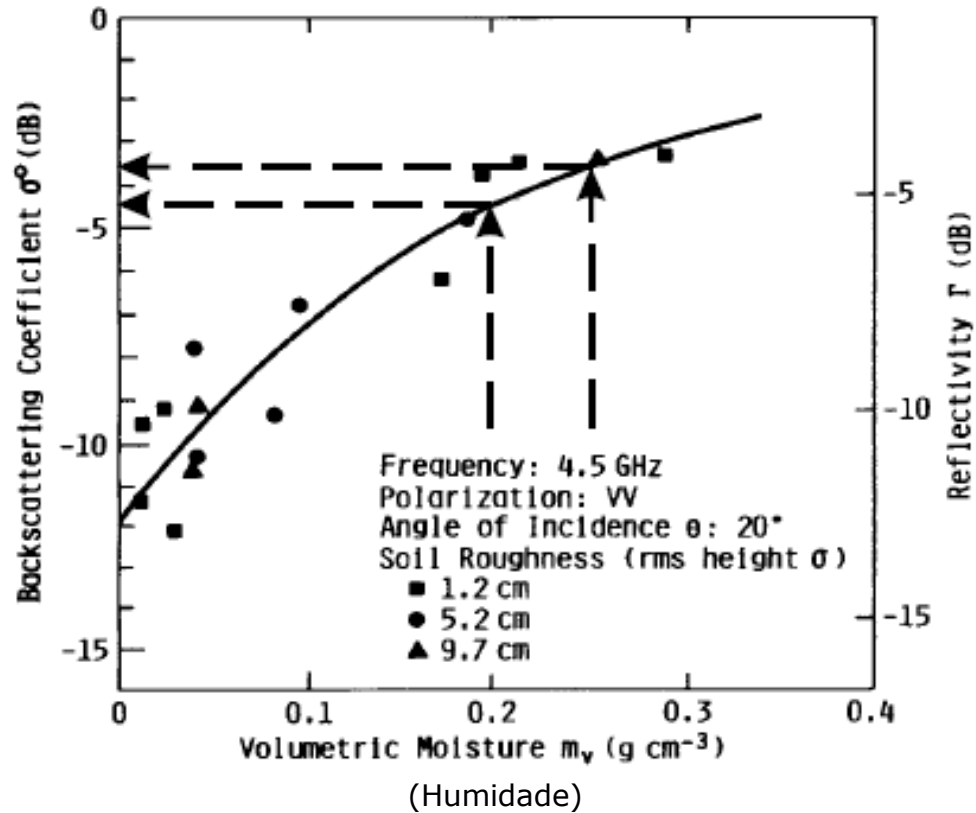

Resultado experimental realizado com um "scatererometer"

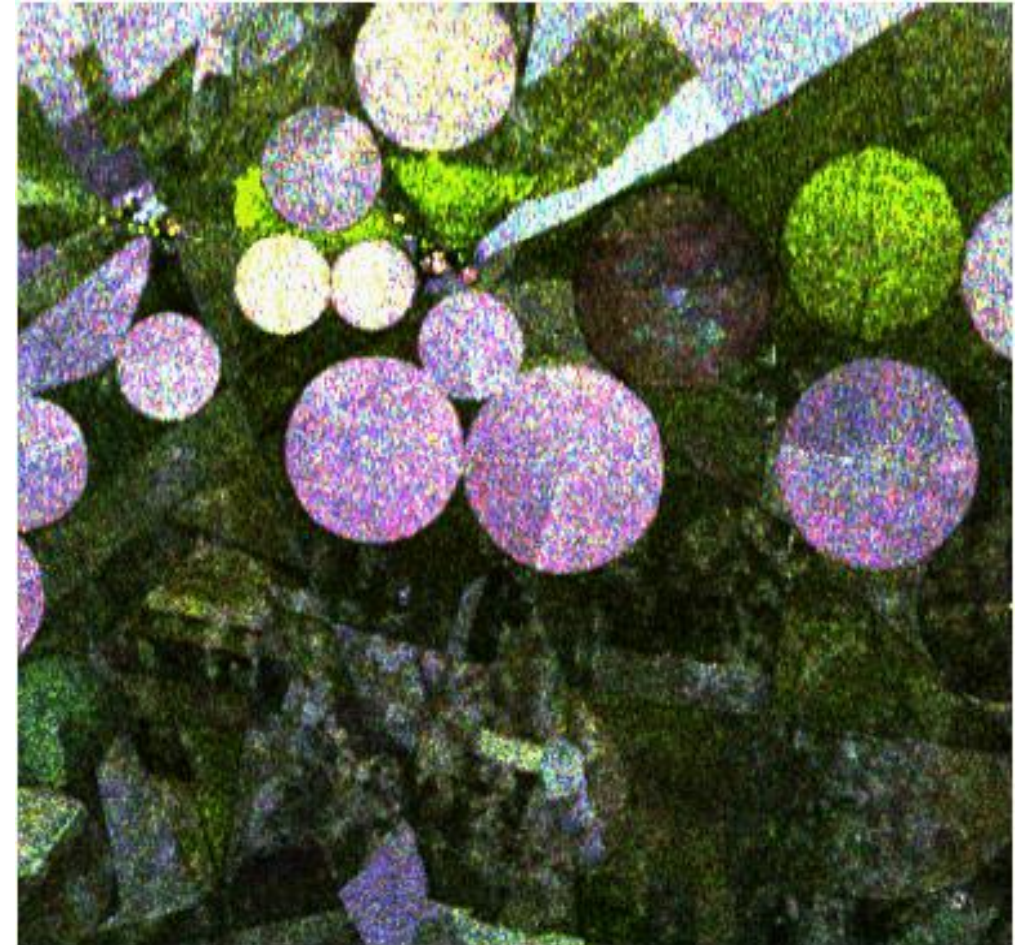

Campos irrigados têm maior backscatterer

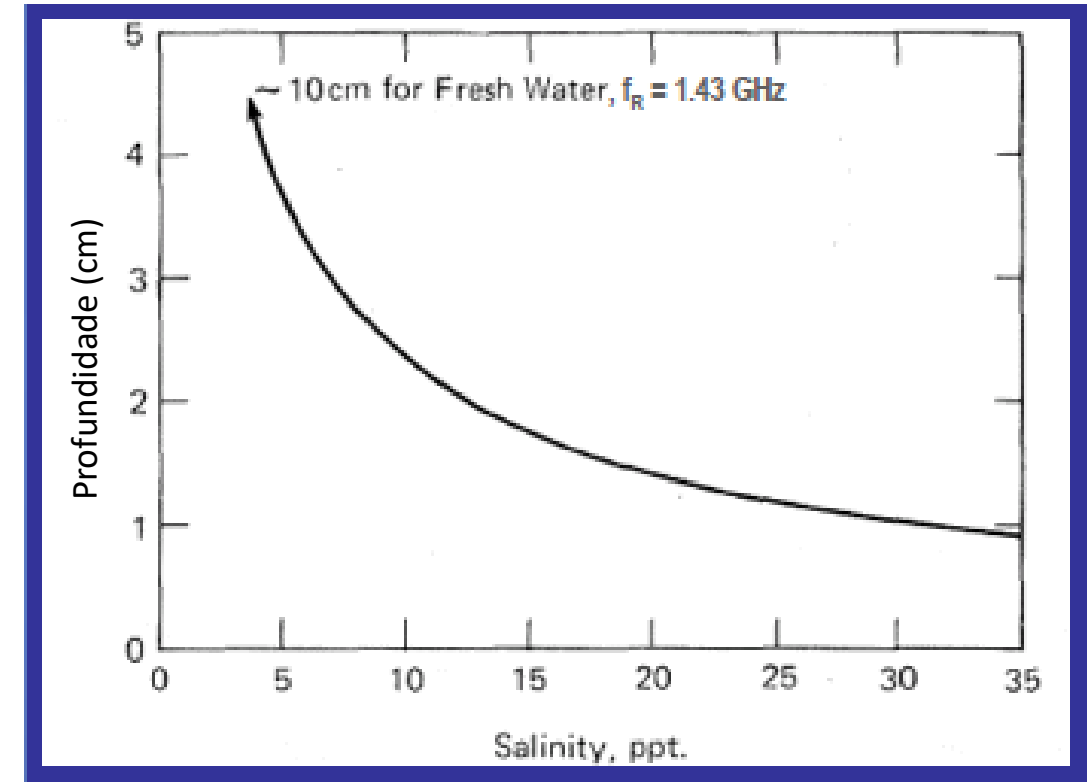
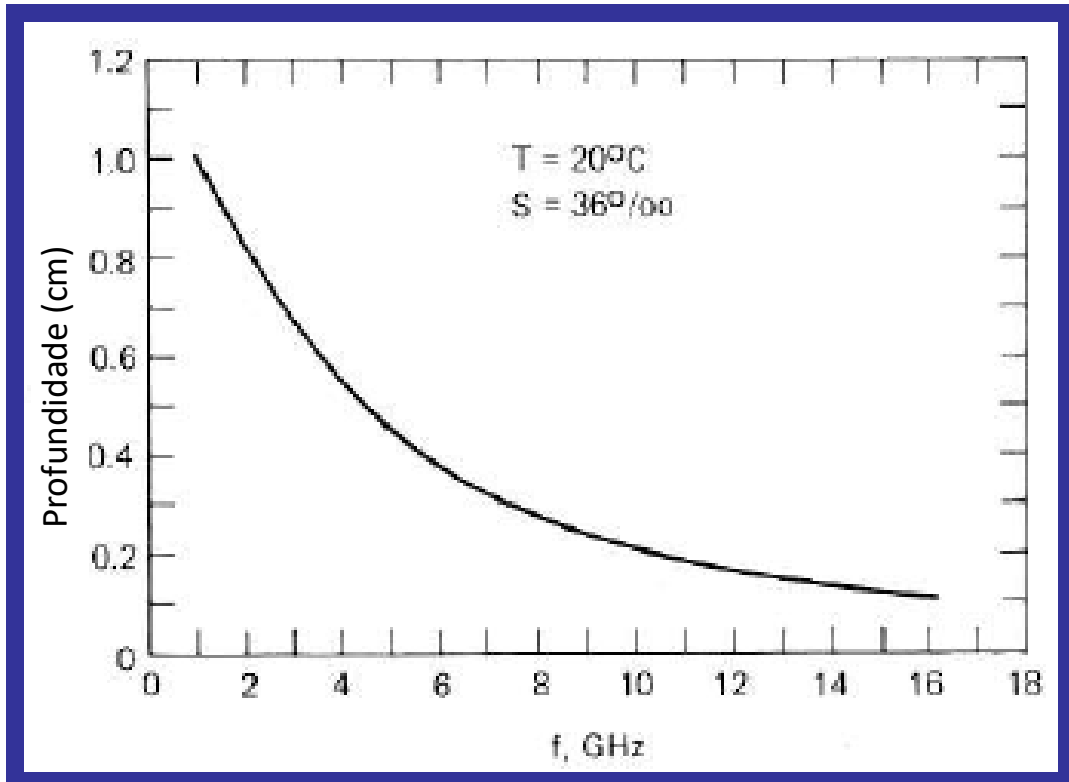

A profundidade de penetração do sinal na água depende das propriedades dielétricas da água e do comprimento de onda do sinal Radar.

As propriedades dielétricas dependem da salinidade e da temperatura.

L : 1.25 GHz

C : 5.30 GHz

X : 10.0 GHz

ASAR, 2.10.2011

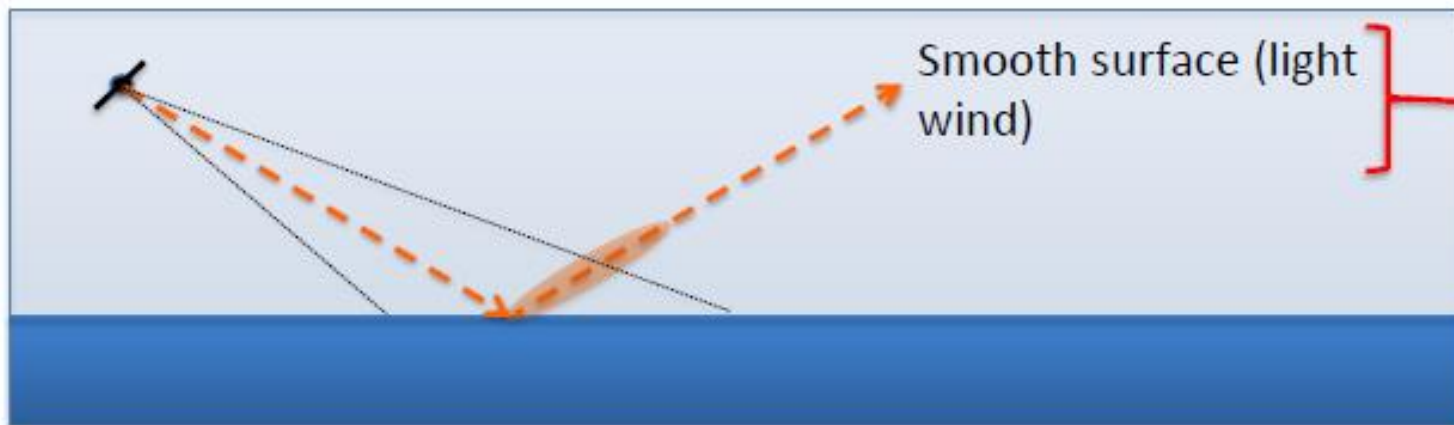

Enhanced backscatter

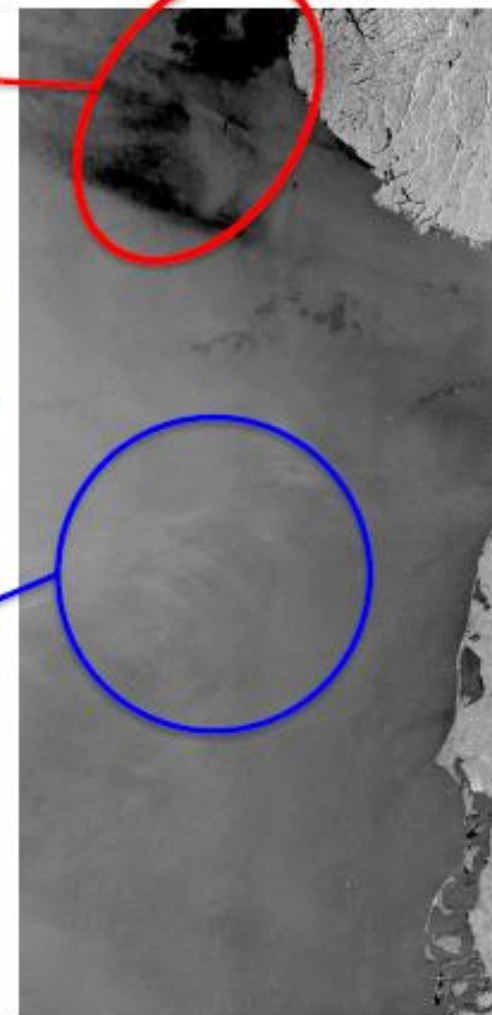
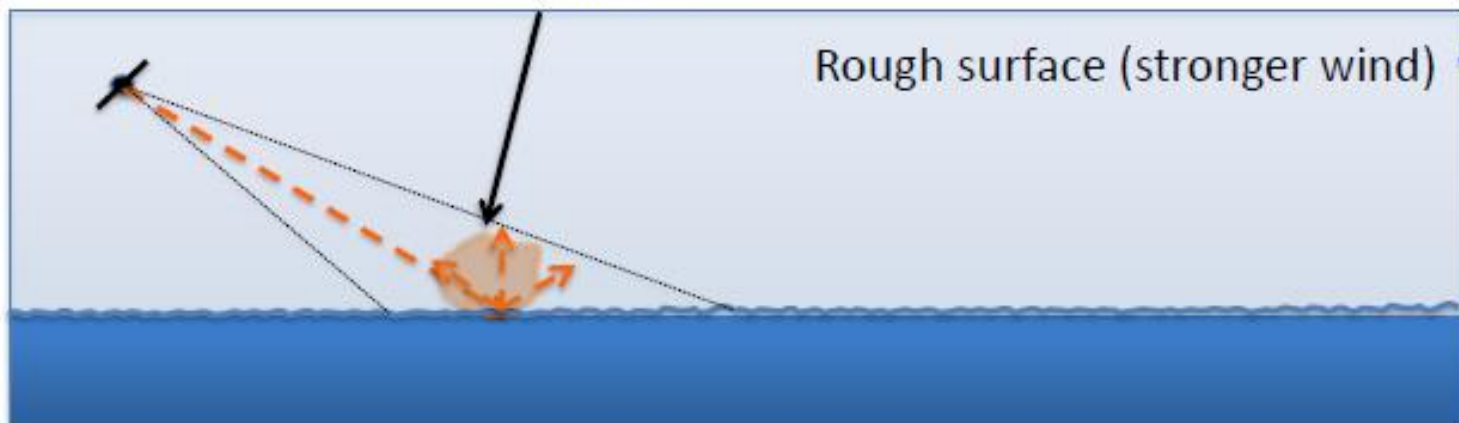

As ondas de Bragg são ondas com comprimento de onda proporcional a metade do comprimento de onda do sinal para ângulos de incidência entre os 20 e os 50 graus.

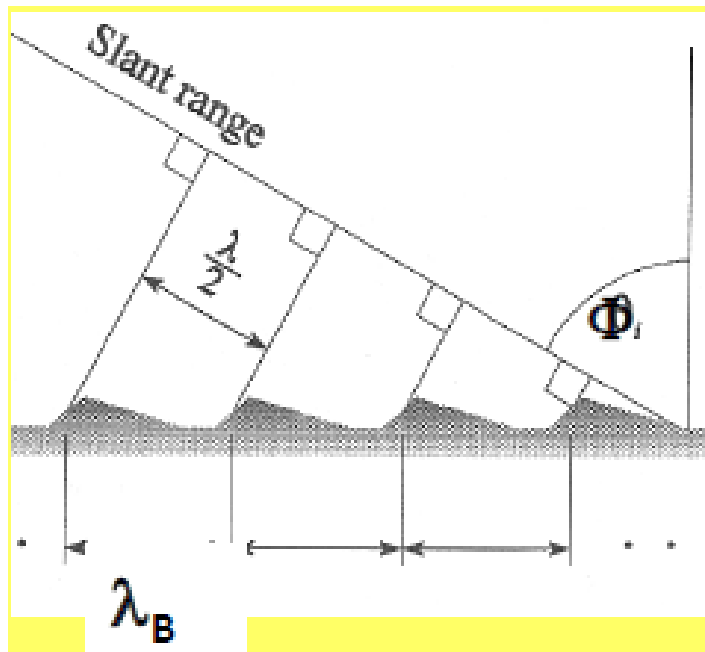

$$\lambda_B = \frac{\lambda}{2} \sin \theta$$

λ_B comprimento de onda de Bragg, θ angulo incidencia

$$1.25 \text{ cm} = \frac{5 \text{ cm}}{2} \sin 30$$

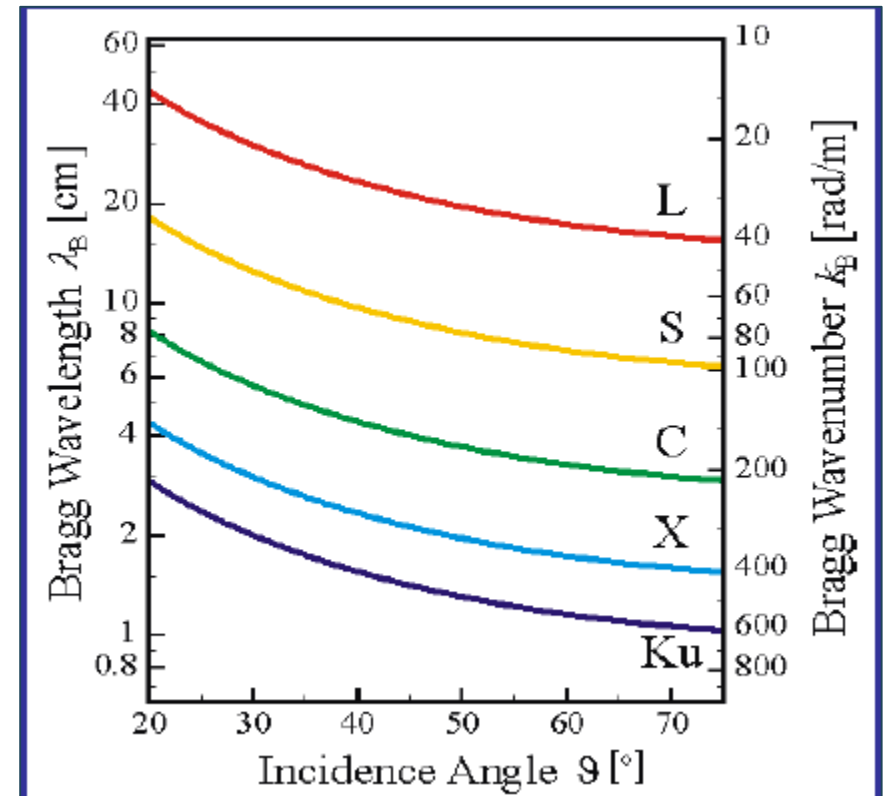

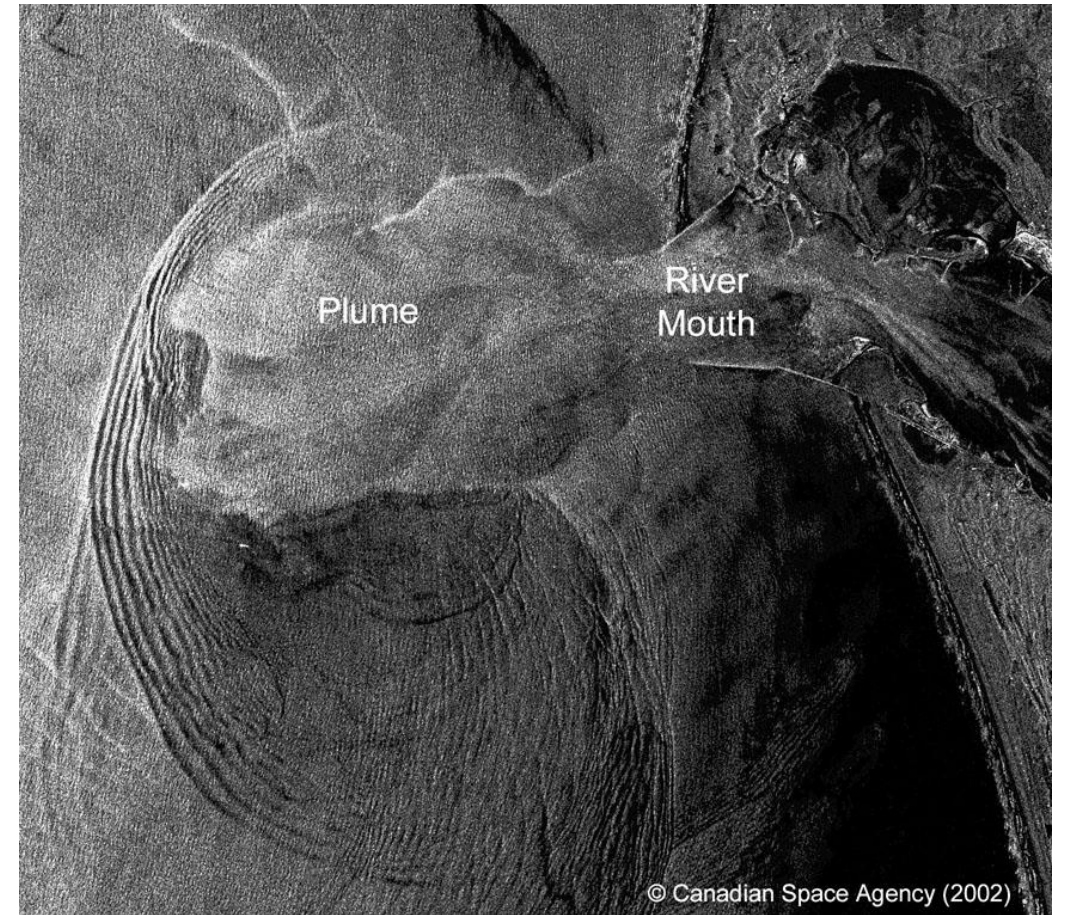
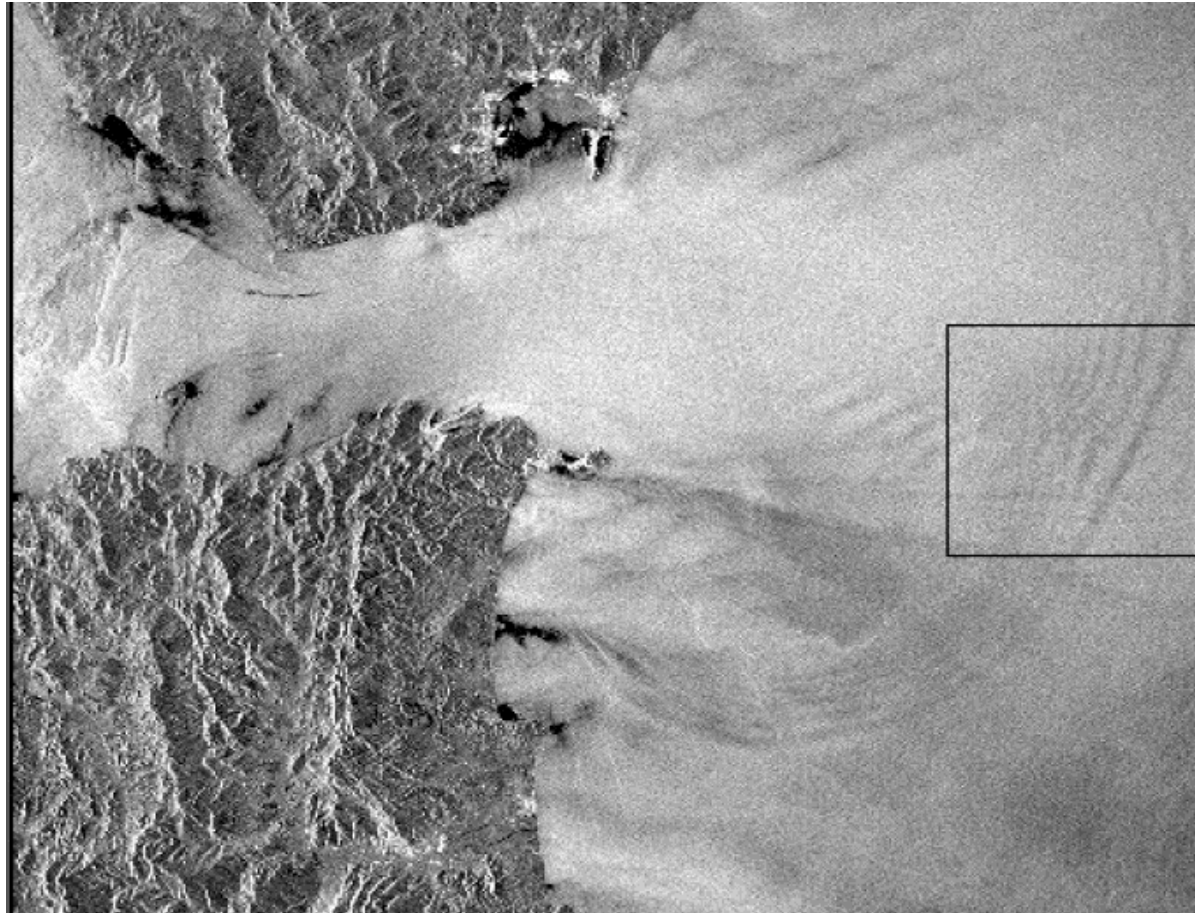

Designamos por **volume scattering** quando o feixe radar penetra o topo de uma superfície e ocorre a dispersão por múltiplas reflexões entre os elementos no interior do volume.

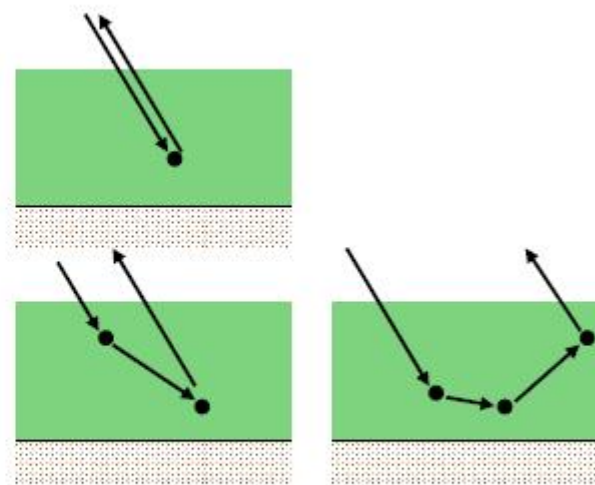
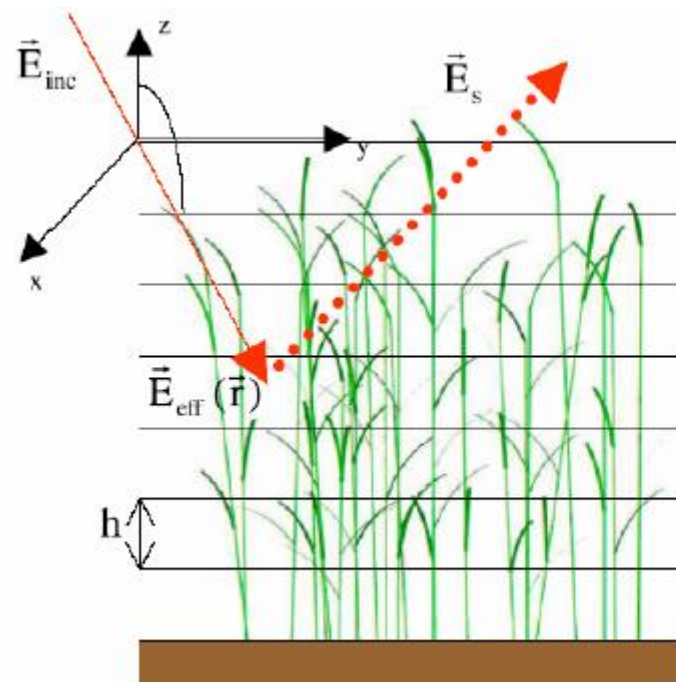

Single and multiple scattering



Varzea Dry Season



Varzea Wet Season

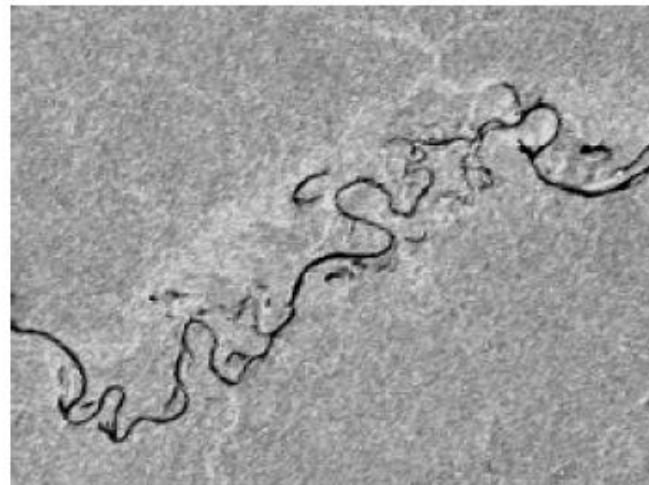

P-band image

Document S.Saatchi, JPL

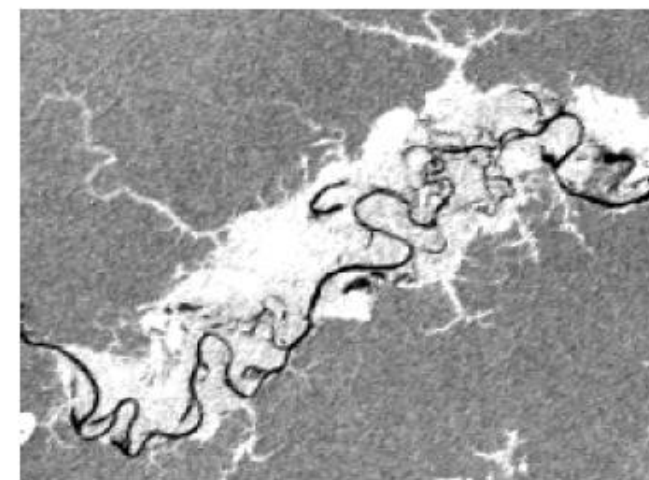

P-band image

Qual a dimensão dos scatterers numa dispersão volúmica.

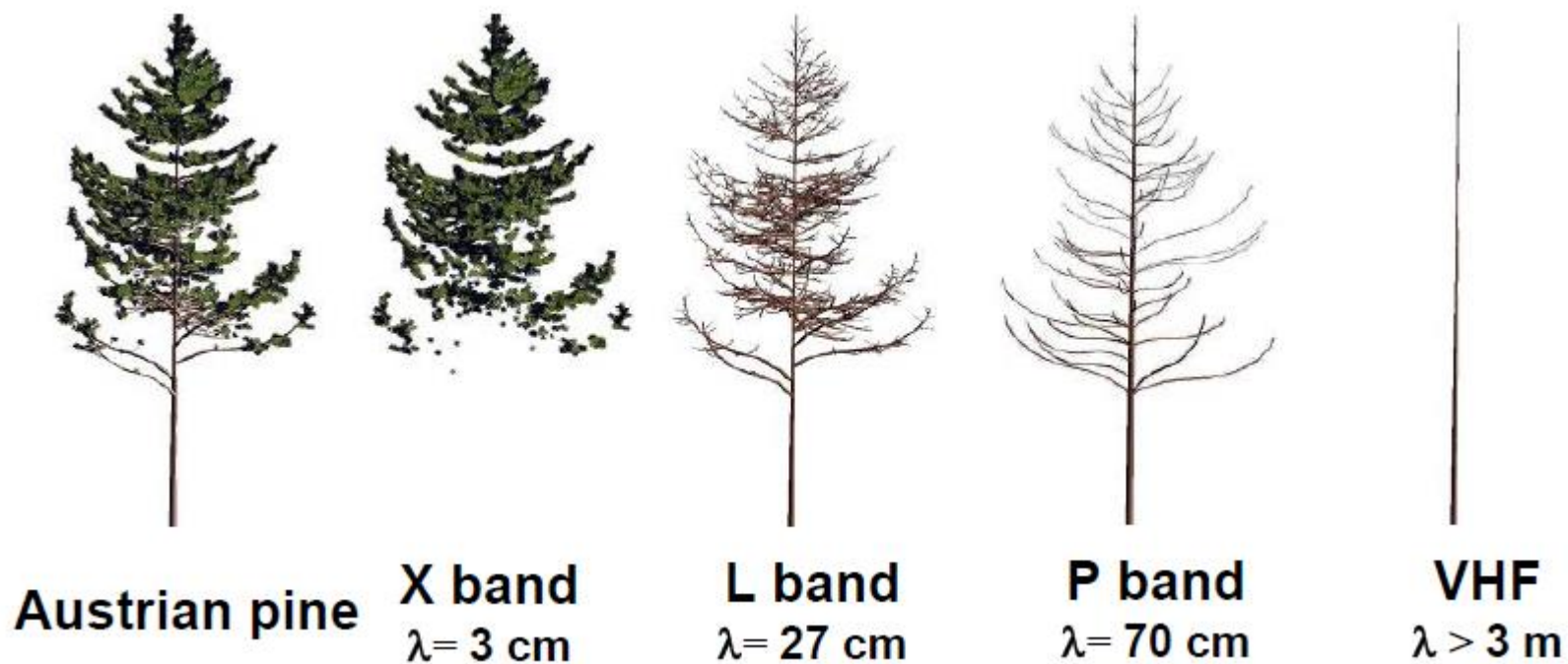

Os principais scatterers são os elementos com dimensão idêntica ao comprimento de onda.

Light interacts most strongly with objects on the size of the wavelength

Forest: Leaves reflect X-band wavelengths but not L-band

Dry soils: Surface looks rough to X-band but not L-band

Ice: Surface and layering look rough to X-band but not L-band

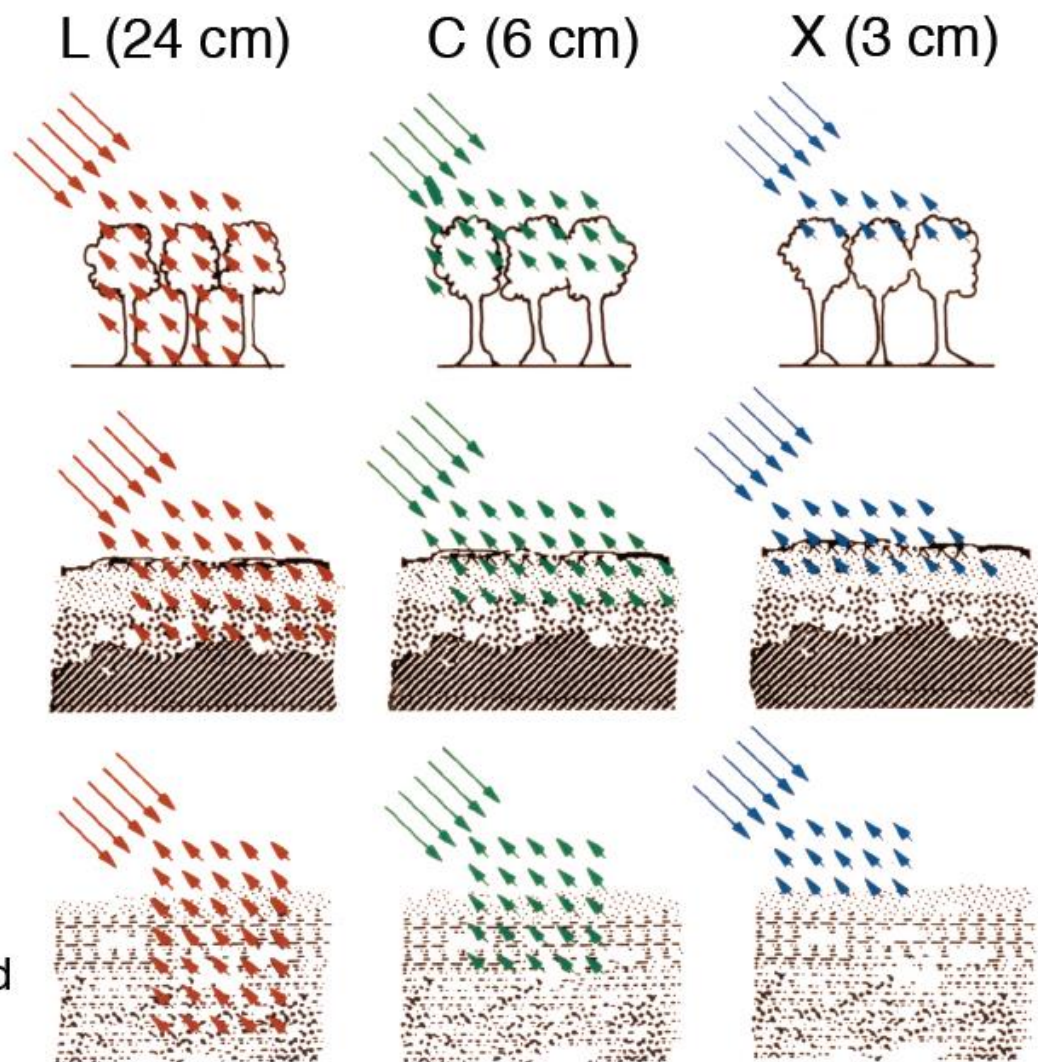

(adapted JPL, 2010)

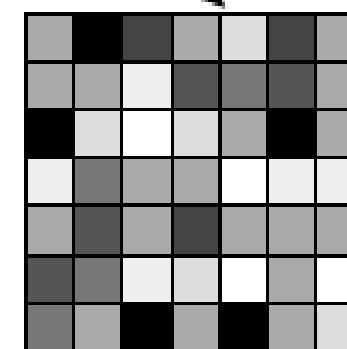
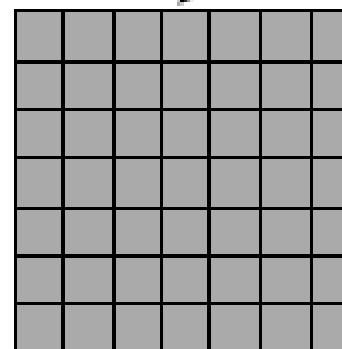
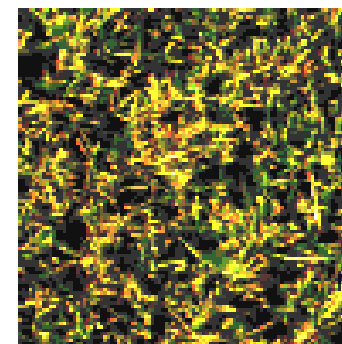
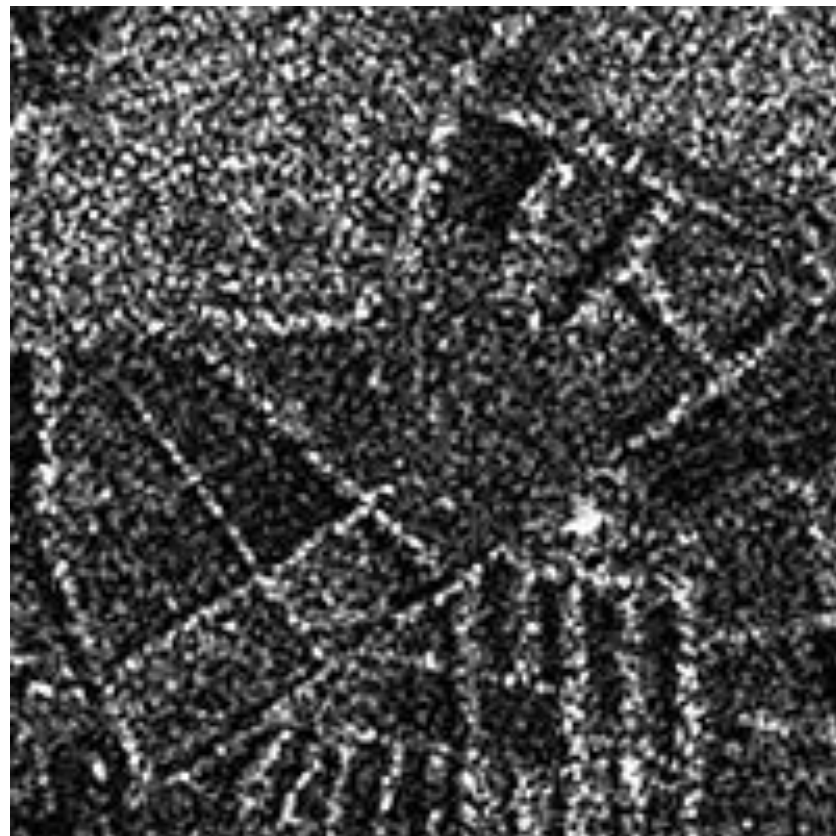

A

B

© CCRS / CCT

O *speckle* é causado pela interferência destrutiva e construtiva de muitos ecos de dispersão que ocorrem numa única célula.

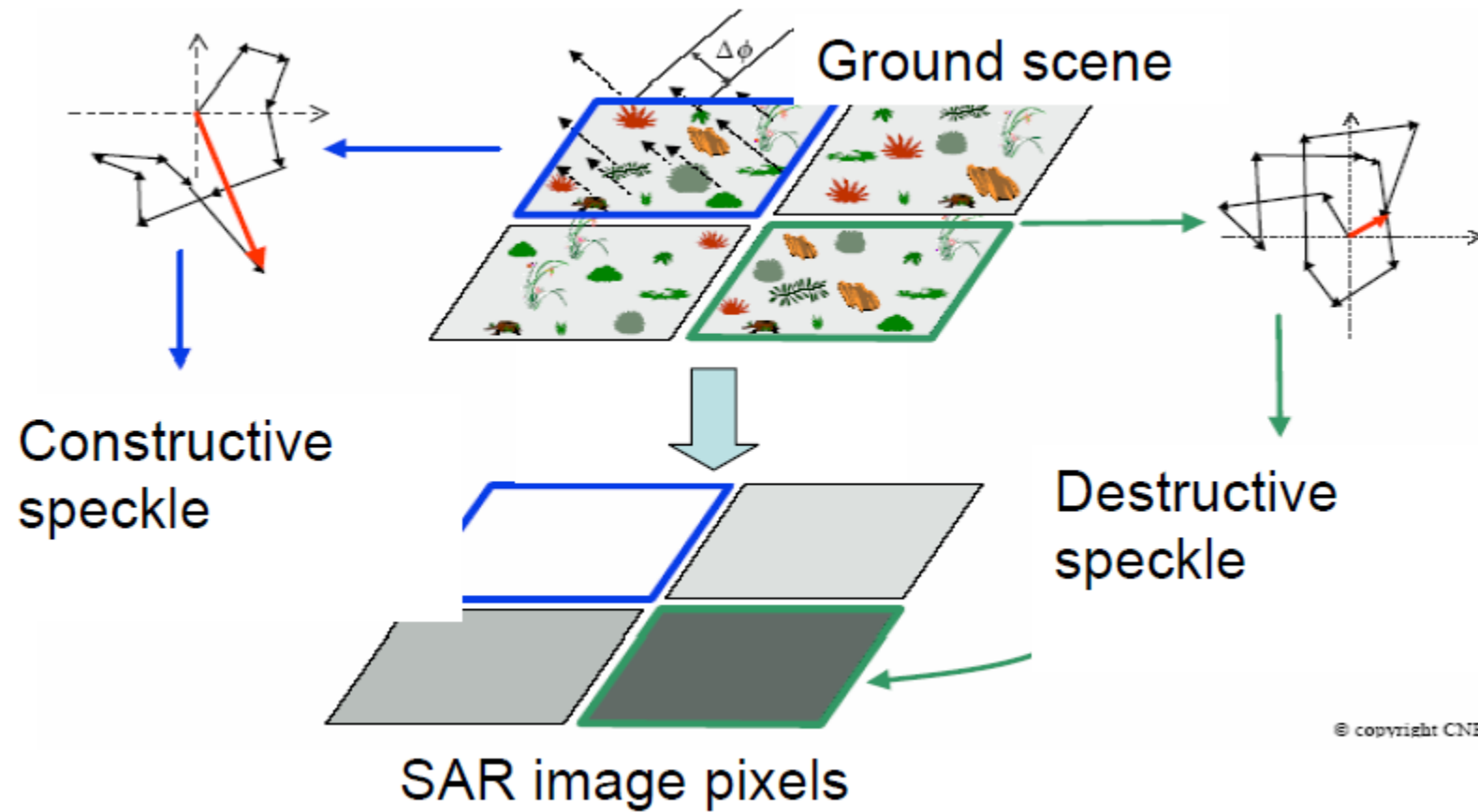

© copyright CNE:

As células são feitas de dispersores com diferentes valor de fase causando interferência e o speckle (efeito tipo ruído).

Speckle noise is multiplicative, i.e. $I = X \cdot N$, where X is the SAR “signal”, N the speckle noise and I the noise SAR image

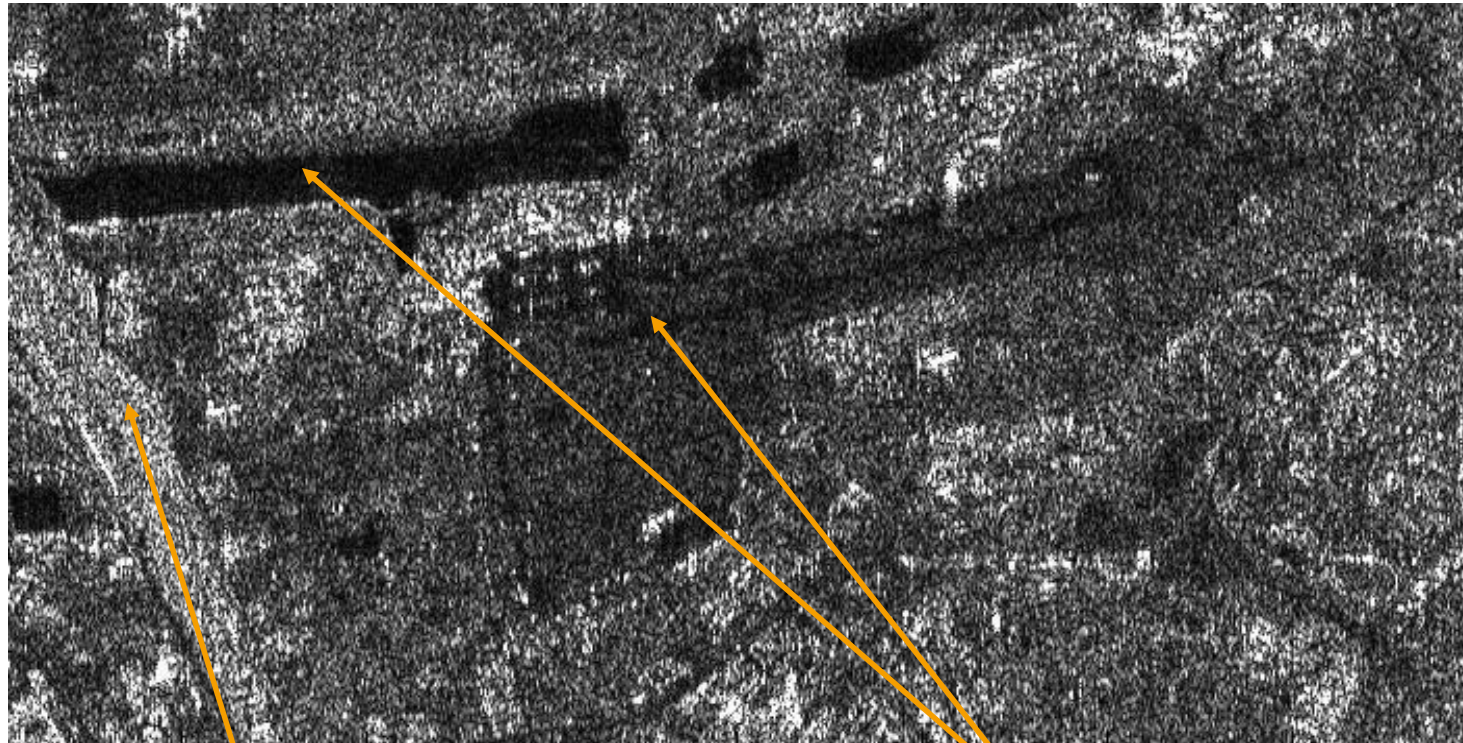

Bright SAR signal
⇒ High speckle noise

Dark SAR signal
⇒ Low speckle noise

Multiplicative noise means the higher the SAR signal at pixel (x,y) the higher the noise level.

$$I(x,y) = X(x,y) \cdot N(x,y)$$

where

I = noisy SAR image

X = SAR amplitude

N = speckle noise

Noise speckle has a mean value $\mu_N = 1$ and variance $v_N = 1/L$ with L the number of looks

SAR images are filtered to reduce the impact of speckle phenomenon and facilitated their analysis (visual or quantitative)

Usually speckle filtering algorithms use a moving window sliding over the SAR image to provide the filter image X_{FILT} .

The following quantities are defined:

μ_X	= mean value of X;	μ_N	= mean value of N
S_X	= standard deviation of X;	S_N	= standard deviation of N
V_X	= variance of X;	V_N	= variance of N

They estimated within the moving window. Actually the mean value, the standard deviation and the variance of speckle noise are known in advance and depends only on the number of looks L equal to the window dimension.

O speckle é uma forma de ruído que degrada a qualidade de uma imagem poderá tornar a interpretação (visual ou digital) mais difícil.

A redução do speckle pode ser conseguida de duas formas:

Processamento Multi-look

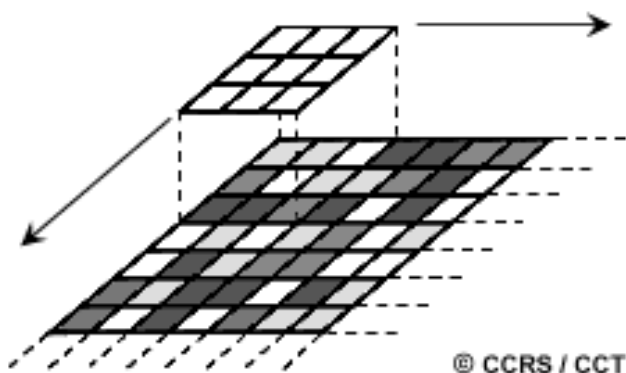

Filtro Espacial

O filtro espacial consiste numa pequena janela de alguns píxeis (ex. 3x3, 5x5) sobre cada píxel na imagem, calculando a média ou qualquer outro valor (filtro) e substituindo o píxel central por este novo valor.

Não-adaptativo: Mediana e média

Adaptativo: Lee, Frost

Median filter

A 3x3 window is used. The value of pixel at the center of the window is updated with the median value of SAR amplitudes of the window pixels. Larger windows could introduce artefacts in the filtered SAR image.

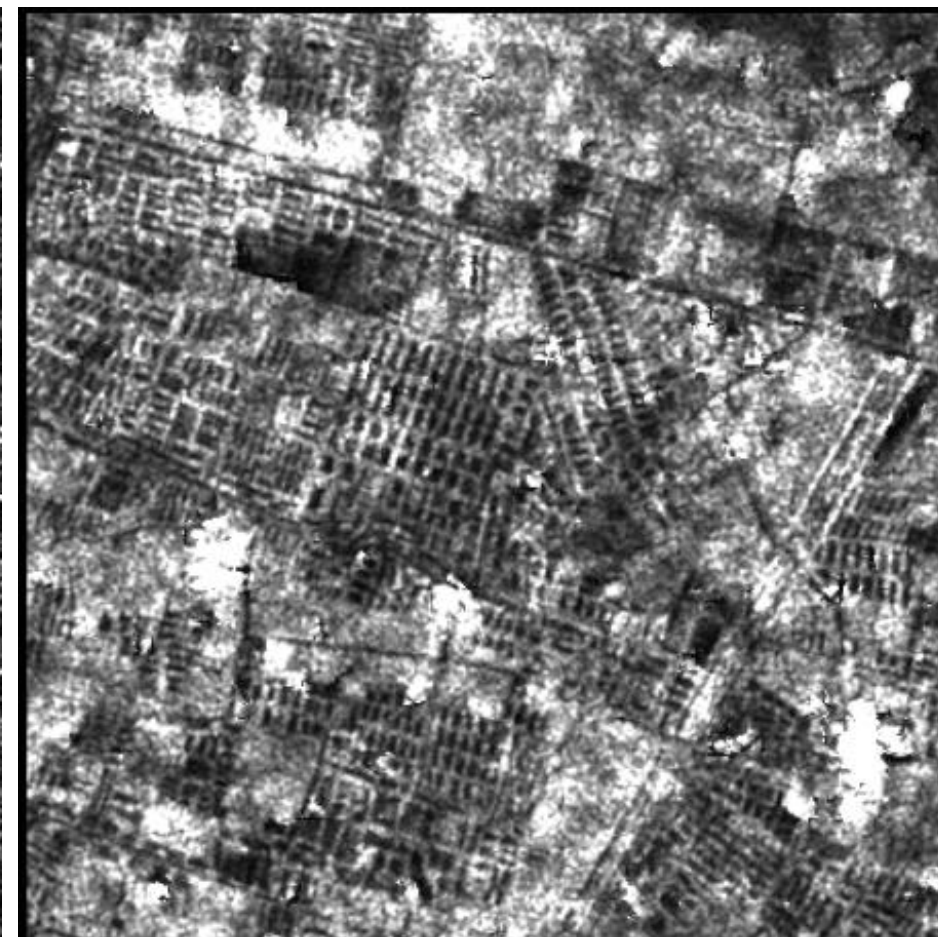
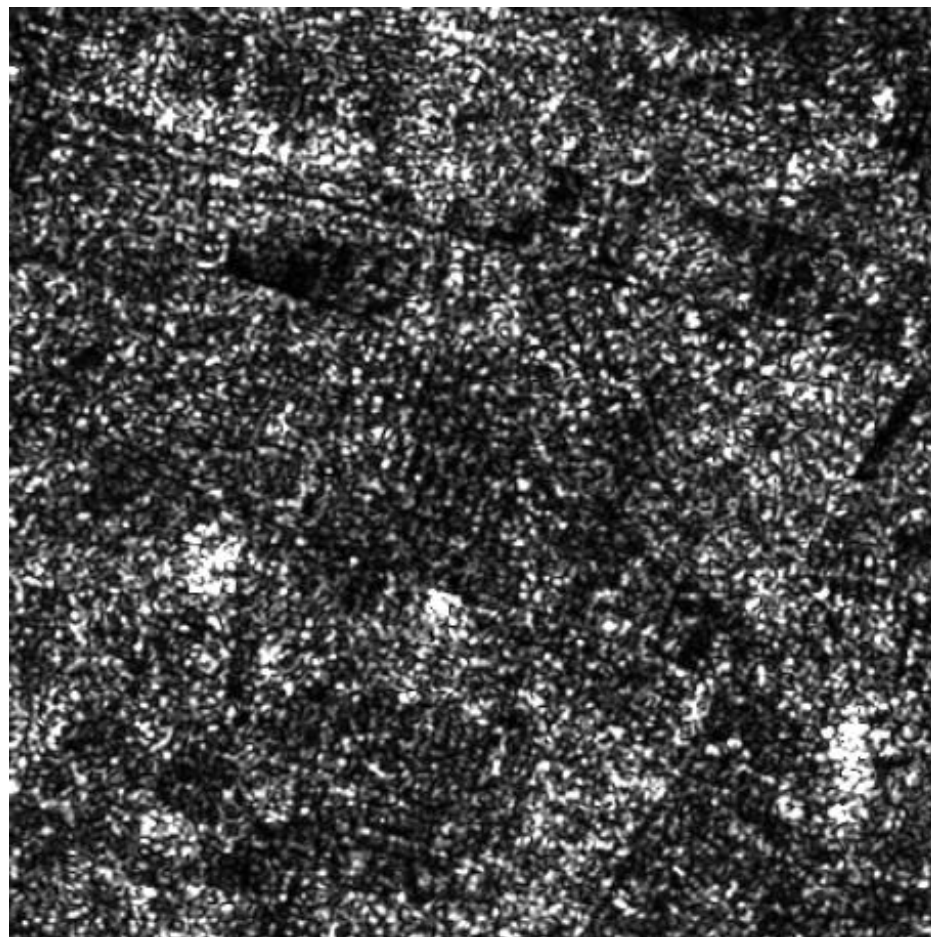

HH image 400 x 400 pixels (of 12.5m)

Filtros de Lee, Lee Refined, Frost ...

This filter update the value of pixel at the center of the window with the mean value of SAR amplitudes of all pixels within the moving window according to a given function (implementada num kernel de dimensão NxN).

Original SAR image

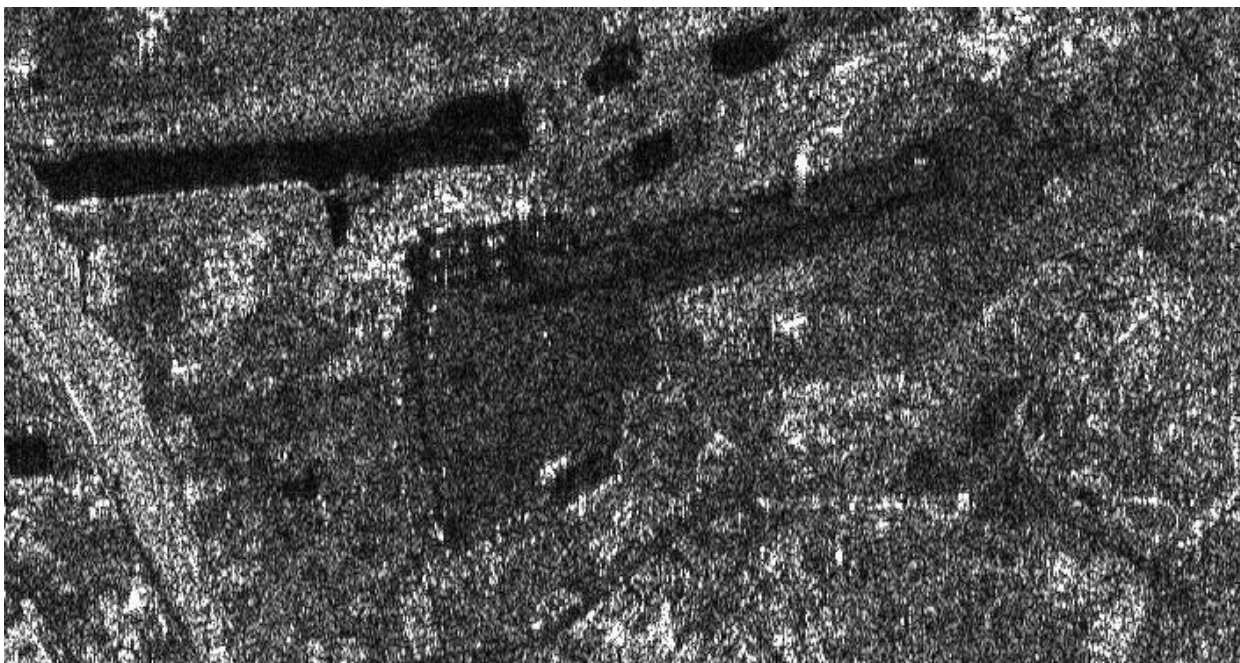

Filtered SAR image



Optical image



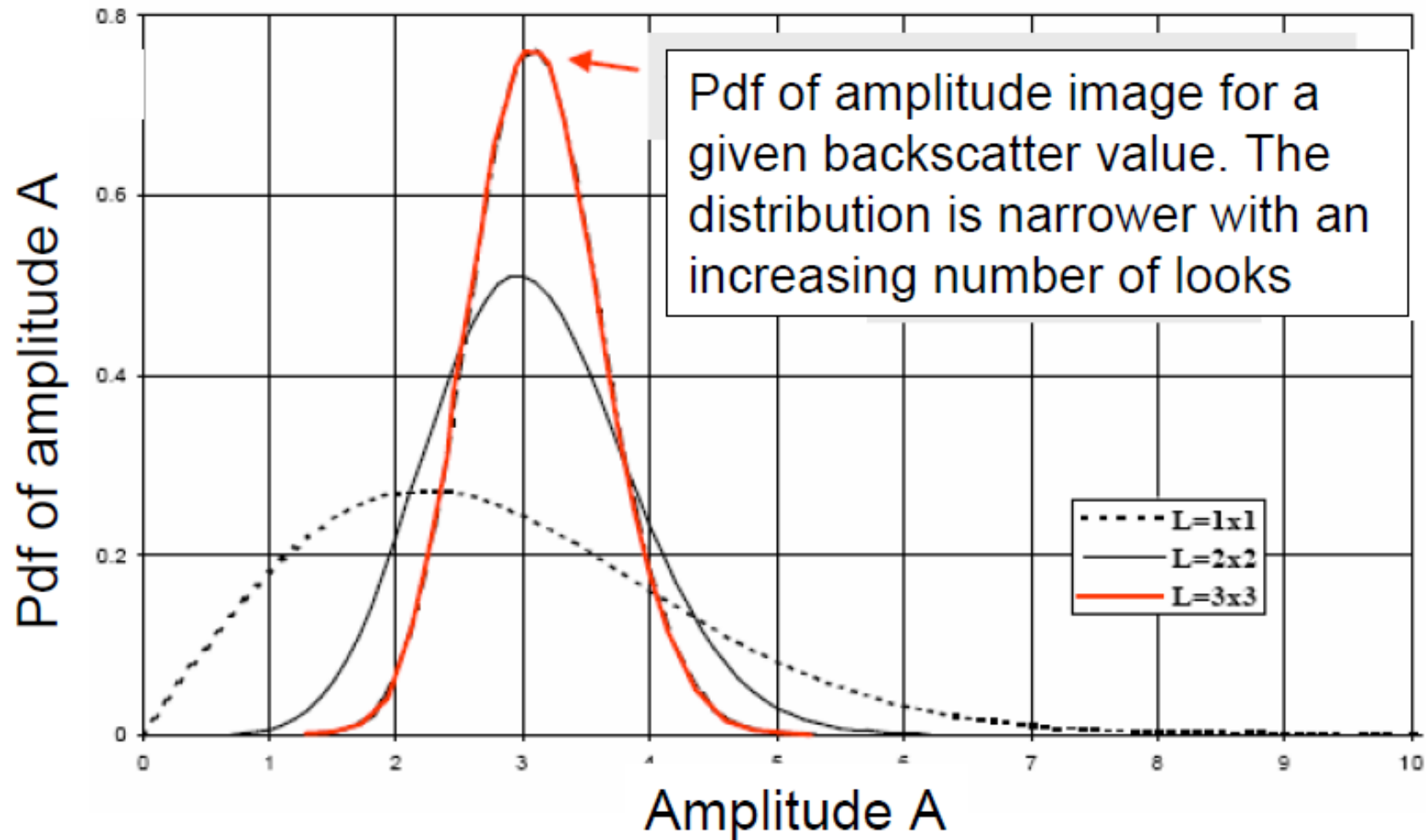

Quer o processamento multi-look quer o filtro espacial são feitos à custa da diminuição da resolução da imagem.

A polarização de uma onda refere-se à orientação do campo eléctrico.

Os radares são construídos para **transmitir** radiação microondas com polarização Horizontal (H) ou Vertical (V).

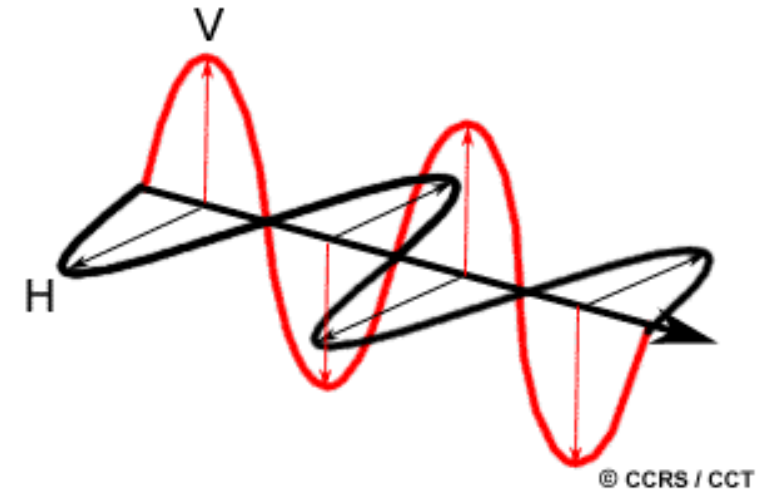

As antenas recebem a energia backscattered com polarização horizontal ou vertical e alguns sensores recebem ambas. Podemos assim ter as combinações:

- HH – Transmissão e recepção Horizontal,
 - VV – Transmissão e recepção Vertical,
 - HV – Transmissão Horizontal e recepção Vertical
 - VH - Transmissão Vertical e recepção Horizontal
- } Polarização cruzada

Banda C

Polarização
HH (esquerda)
e VV (direita)



Polarização HV

Composição
colorida

HH - Red,
VV - Green,
HV - Blue

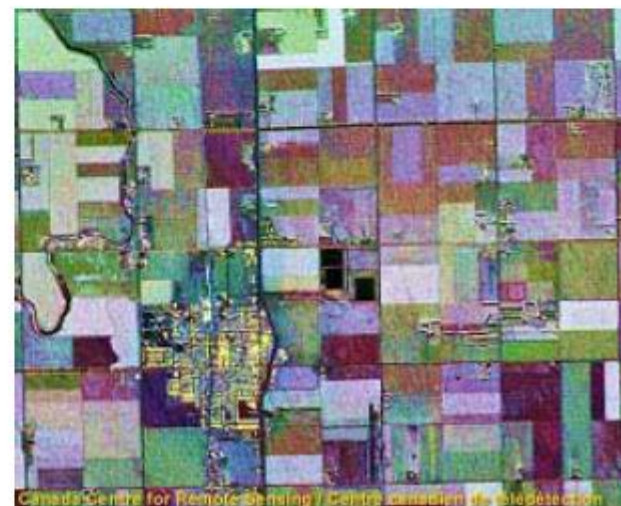

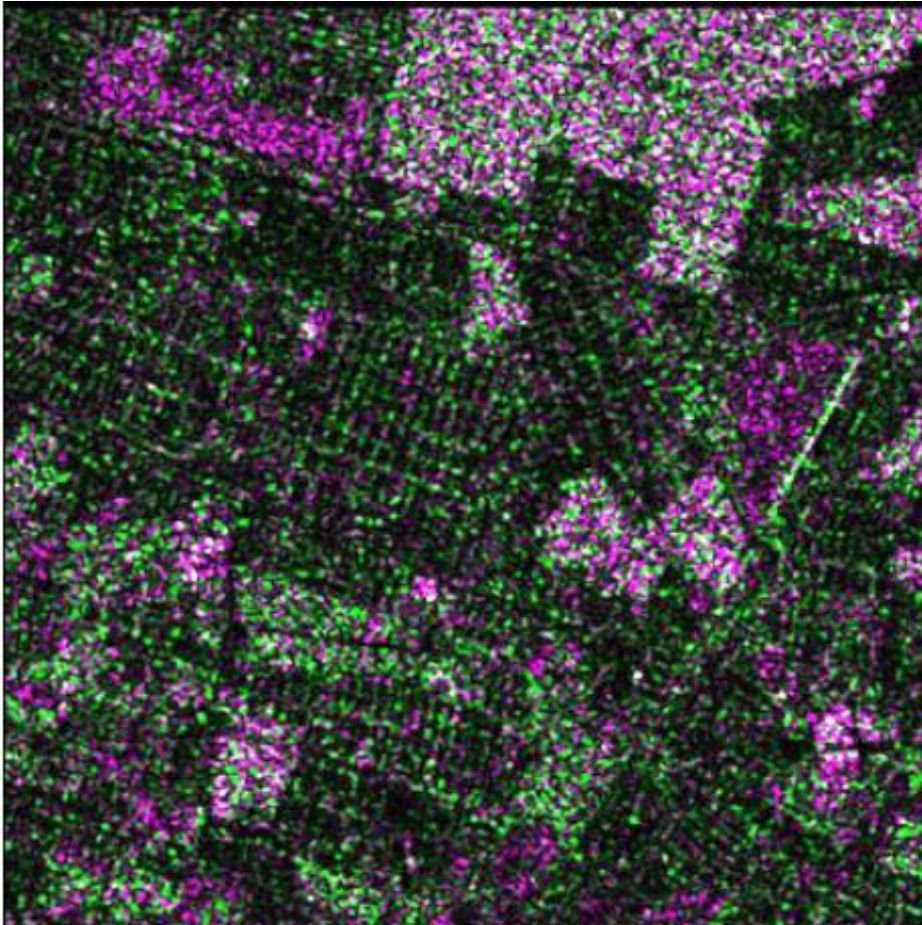

HH (magenta) and VV (green) images
400 x400 píxeis

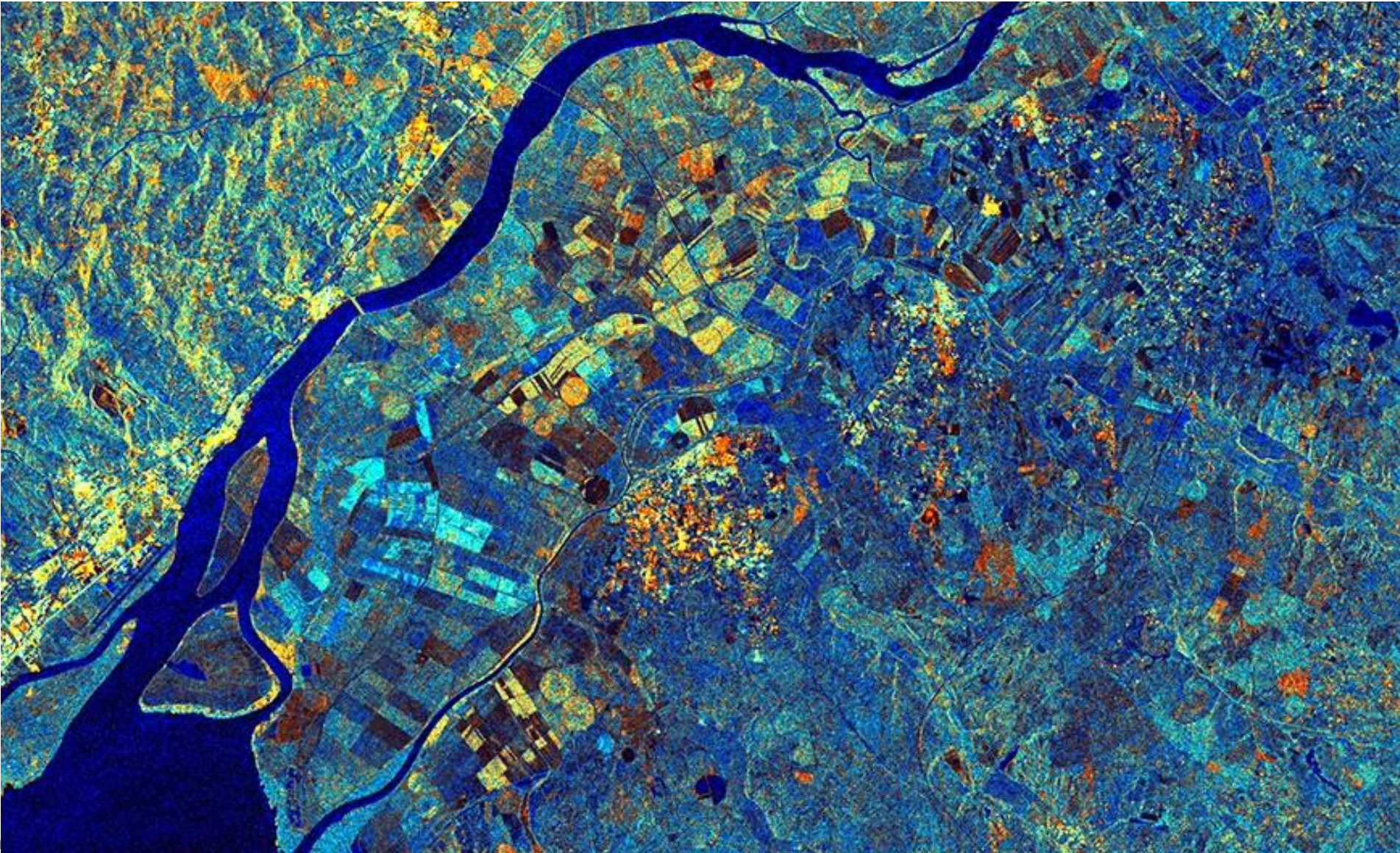

Missões Microondas

The SMOS mission is a direct response to the current lack of global observations of soil moisture and ocean salinity, which are needed to further our knowledge of the water cycle, and to contribute to better weather, extreme-event and seasonal-climate forecasting.

Variability in soil moisture and ocean salinity is due to the continuous exchange of water between the oceans, atmosphere and land – Earth's water cycle.



About SMOS

What?

SMOS (Soil Moisture and Ocean Salinity) is one of ESA's Earth Explorers dedicated to capturing 'brightness temperature' images of Earth's surface



Innovative

SMOS carries the first spaceborne microwave **interferometric radiometer (MIRAS)** to measure Earth's surface radiation at 1.4 GHz

When?

Launched 2 November 2009, initially designed as a five-year mission, it is **still delivering key information** to advance science and data used in various practical applications, such as weather forecasting



Applications?

It is the first mission to provide global observations of the temporal and spatial variability in **soil moisture** and **sea surface salinity**, which are driven by the continuous exchange in Earth's water cycle between the oceans, atmosphere and land



What's next?

Going way beyond its original scientific aim of delivering critical information to understand Earth's water cycle, **SMOS continues to demonstrate its suitability for new uses**. Some examples include:



- providing information to **measure thin ice floating** in the polar seas accurately enough for **forecasting and ship routing**
- measurements of severe winds over oceans to support tropical **cyclone monitoring** and forecasting
- **measuring the solar flux** to support space weather applications and solar science studies

Benefits?

These **key geophysical parameters**—soil moisture for understanding hydrometeorological processes and salinity for understanding of ocean circulation—are both vital for climate change studies. Its images are used to derive global maps of soil moisture and sea surface salinity **every three days**, at a **spatial resolution of about 50 km**

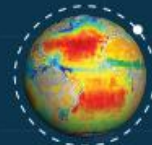

Data and Users

Since the beginning of the SMOS mission, around 24.2 million products have been downloaded from ESA's SMOS dissemination service, by more than 1700 active users, for a total volume of 920 TB of data



Data Access

<https://smos-diss.eo.esa.int/oads/access>

Where?

The PROTEUS spacecraft platform SMOS utilises was designed and built by **CNES** and **Alcatel Alenia Space**, while the **MIRAS** instrument was designed and built by a consortium of 20 European companies, led by **EADS-Casa Espacio (now Airbus)**



The mission objectives are:

- (1) To provide global volumetric soil moisture estimates with an accuracy of $0.04 \text{ m}^3\text{m}^{-3}$ at a spatial resolution of 35-50 km and a temporal sampling of 1-3 days and
- (2) To provide global ocean salinity estimates with an accuracy of 0.1 practical salinity scale units for a 10-30 day average for an open ocean area of $200 \times 200 \text{ km}^2$,
- (3) to provide daily sea ice thickness estimates based on MIRAS observations for the Northern hemisphere with a spatial resolution of a 10.000 km^2 up to maximum values of 50 cm.

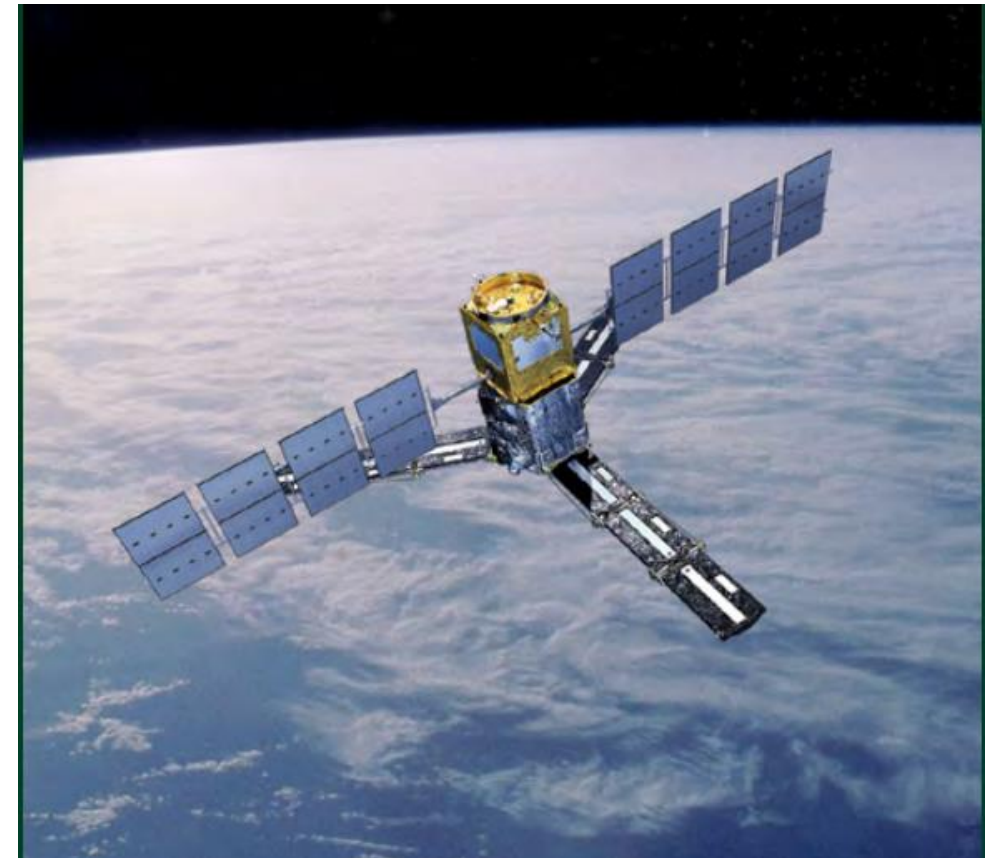

The SMOS mission is based on a sun-synchronous orbit (dusk-dawn 6am/6pm). SMOS measurements are made over a range of incidence angles (0 to 55°) across a swath of approximately 1000 km with a spatial resolution of 35 to 50 km. MIRAS can provide measurements in dual and full polarisation, with the latter being its present operating mode.

MIRAS

The Microwave Imaging **Radiometer** using Aperture Synthesis (MIRAS) instrument is a passive microwave 2-D interferometric radiometer (L-Band, 1.4GHz, 21 cm) onboard the SMOS satellite.

It picks up faint microwave emissions from Earth's surface to map levels of soil moisture, sea surface salinity, sea ice thickness and others geophysical variable such as wind speed over ocean and freeze / thaw soil state.

MIRAS consists of a central structure and three deployable arms.

The 69 antenna elements (LICEF receivers) are equally distributed over the three arms and the central structure. Each LICEF is an antenna-received integrated unit that measures the radiation emitted from the Earth at L-band. The acquired signal is transmitted to a central correlator unit, which performs interferometry cross-correlations of the signals.

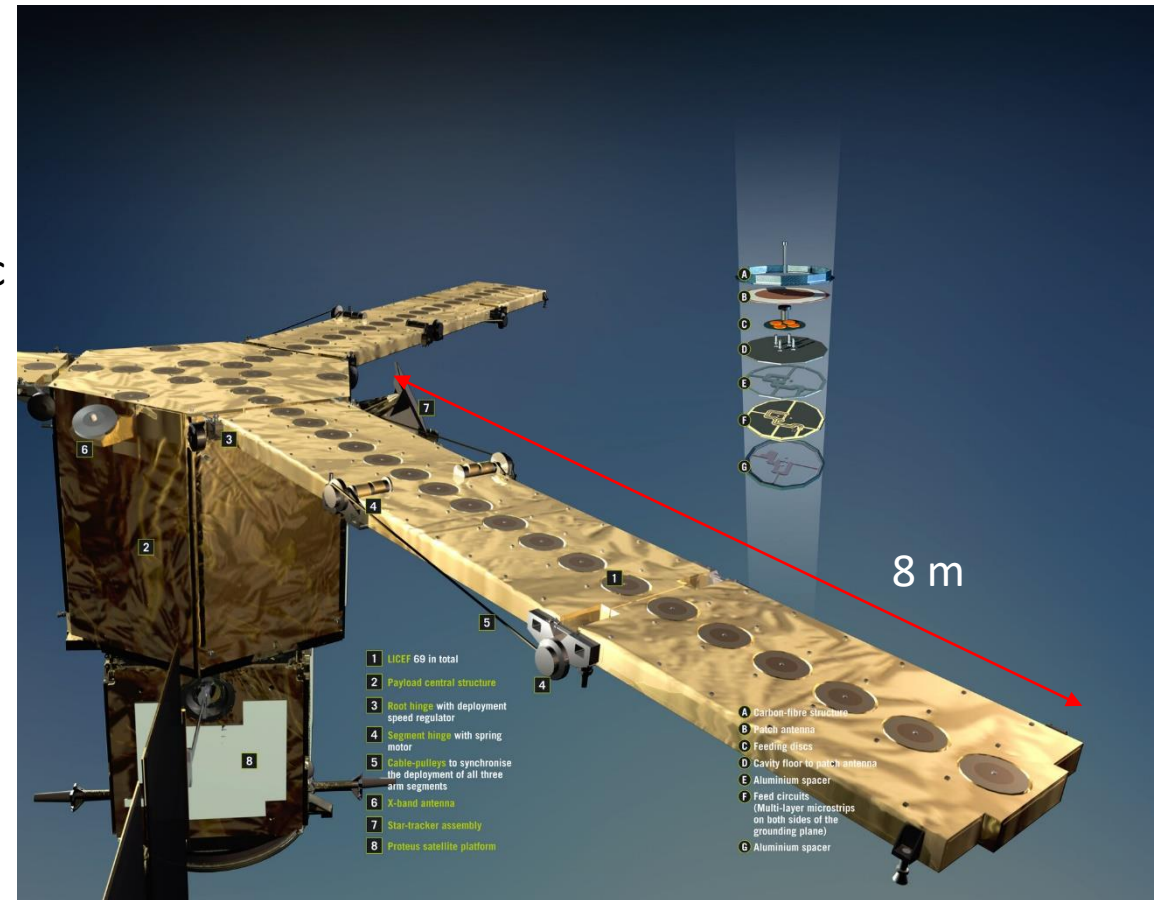

Missões com sensores activos

Spaceborne SAR Systems



SEASAT
NASA/JPL (USA)
L-Band, 1978

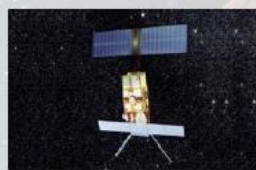

ERS-1/2
European Space Agency (ESA)
C-Band, 1991-2000/1995-2011



J-ERS-1
Japanese Space Agency (JAXA)
L-Band, 1992-1998



SIR-C/X-SAR
NASA/JPL, L- and C-Band (quad)
DLR / ASI, X-band 1994



RadarSAT-1
Canadian Space Agency (CSA)
C-Band, 1995-2013



Shuttle Radar Topography Mission (SRTM)
NASA/JPL (C-Band), DLR (X-Band)
February 2000



ENVISAT / ASAR
European Space Agency (ESA)
C-Band (dual), 2002-2012



ALOS / PALSAR
Japanese Space Agency (JAXA)
L-Band (quad), Jan. 2006-2011



SAR-Lupe
BWB, Germany
5 satellites, X-Band, 2006/2008

Spaceborne SAR Systems

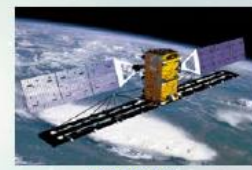

RadarSAT-II
Canadian Space Agency (CSA)
C-Band (quad), 2007



TerraSAR-X/TanDEM-X
DLR /Astrium, Germany
X-Band (quad), 2007/2010



COSMO-SkyMed
ASI, Italy
4 Satellites, X-Band (dual),
2007/2010



Komsat-5
KARI, Korea
X-band (dual), 2013

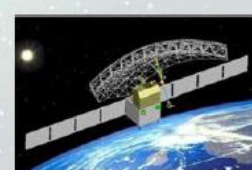

HJ-1C-SAR
CRESDA/CAST/NSRSCC, China
S-Band (HH or VV), 2013

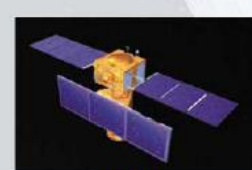

RISAT-1
Indian Space Agency (ISRO), India
C-Band (quad), 2012



SENTINEL-1a/b
ESA, Europe
C-Band (dual), 2014/2015



PAZ
Ministry of Defence, Spain
X-Band (quad), 2014



ALOS-2
Japanese Space Agency (JAXA)
L-Band (quad), 2014

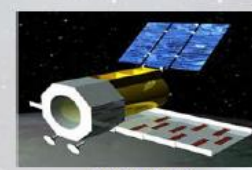

SAOCOM-1/2
CONAE/ASI, Argentina
L-Band (quad), 2016/2018



Radarsat Constellation 1-3
CSA/MDA, Canada
C-band (dual), 2016/2017



BIOMASS
ESA, Europe
P-Band (quad), 2019

<i>Satellite</i>		<i>Agency</i>	<i>Frequency - Polarisation</i>	<i>Resolution - Swath</i>	<i>Special</i>
JERS	1992-1998	JAXA	L-HH	25m 100 km	35° incidence
ERS -1 ERS -2	1991-2000 1995→	ESA	C - VV	25 m 100 km	Interferometry (ERS -1/2)
RADARSAT -1	1995→ 2013	CSA	C - HH	10 -100 m 45 - 500 km	Multi-incidence
ENVISAT - ASAR	2002→ 2012	ESA	C - HH/VV/HV	25 - 1000 m 50 - 500 km	Multi-incidence
ALOS - PALSAR	2006→ 2011	JAXA	L - Polarimetric	10 - 100 m 100 - 350 km	Multi-incidence
TerraSAR -X	2006 ->	DLR	X - Polarimetric	1 - 16 m 5 - 100 km	Multi-incidence

**... and SRTM/X-SAR, RADARSAT-2 (CSA), COSMO-SkyMed (ASI Italy),
Tandem-X, Sentinel-1**

European Space Agency

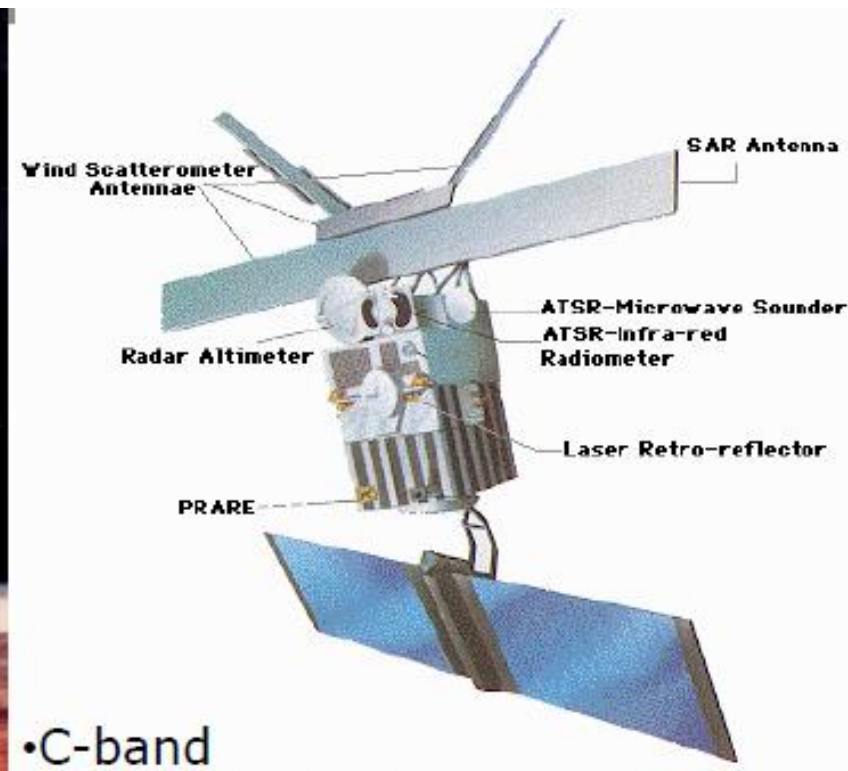
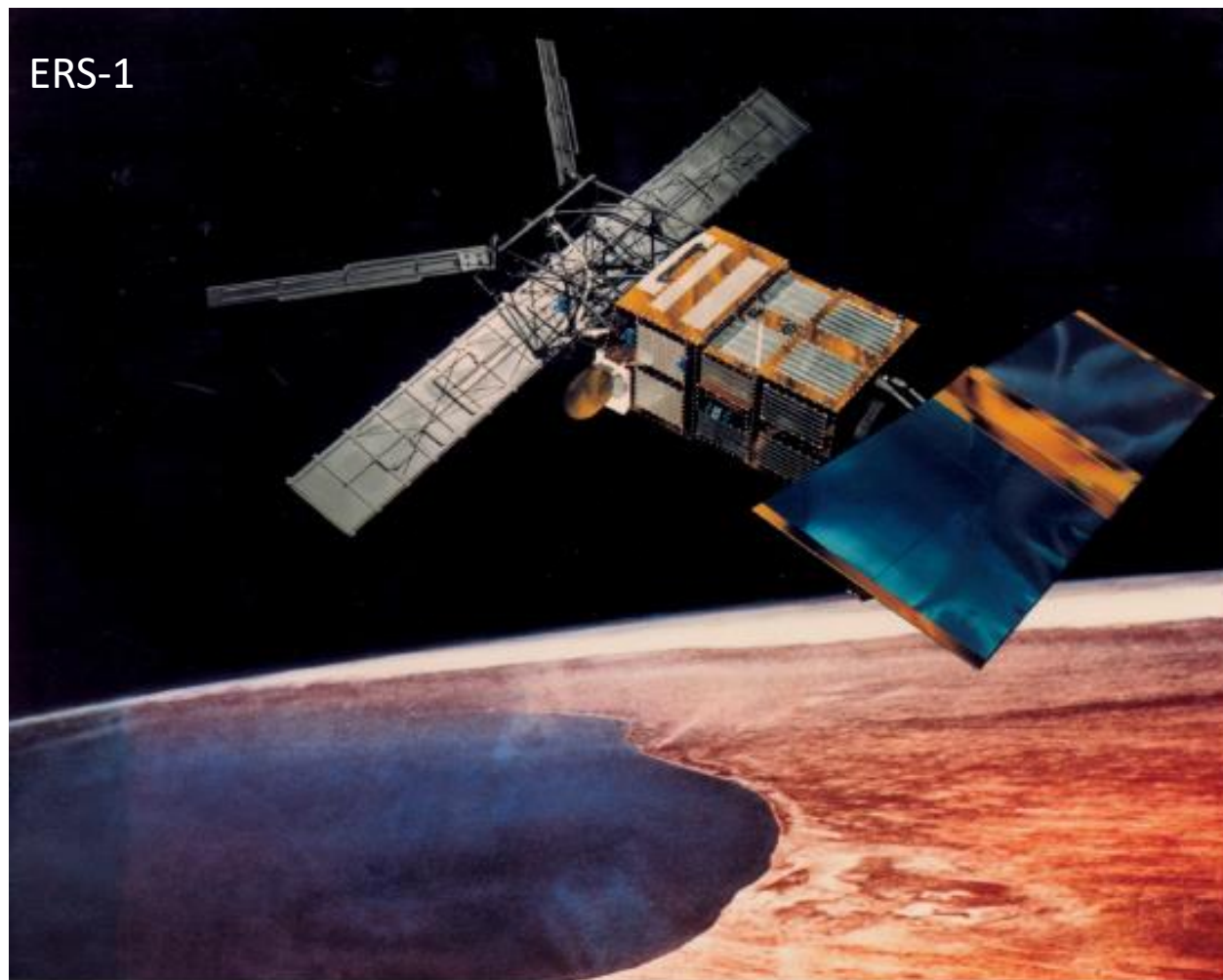

- C-band
- Moderate Swath & Resolution
- Single Polarisation (VV)
- Successful Operations
- Excellent Data Quality
- Application Development
- Emerging Market

- ❑ Largest European satellite & largest worldwide EO satellite:
 - unique combination of 10 instruments addressing land, ocean, ice and atmosphere studies,
 - instruments working nominally, except MIPAS instrument
- ❑ Satellite OK with long-term operations capabilities:
 - 65 % fuel available (about 5 years)
- ❑ 78 different types of data products
 - but many more geophysical parameters
- ❑ 250 Gigabytes of data products generated per day
- ❑ Nominal lifetime (5 years) ends in March 2007
 - but operations funding until end 2010

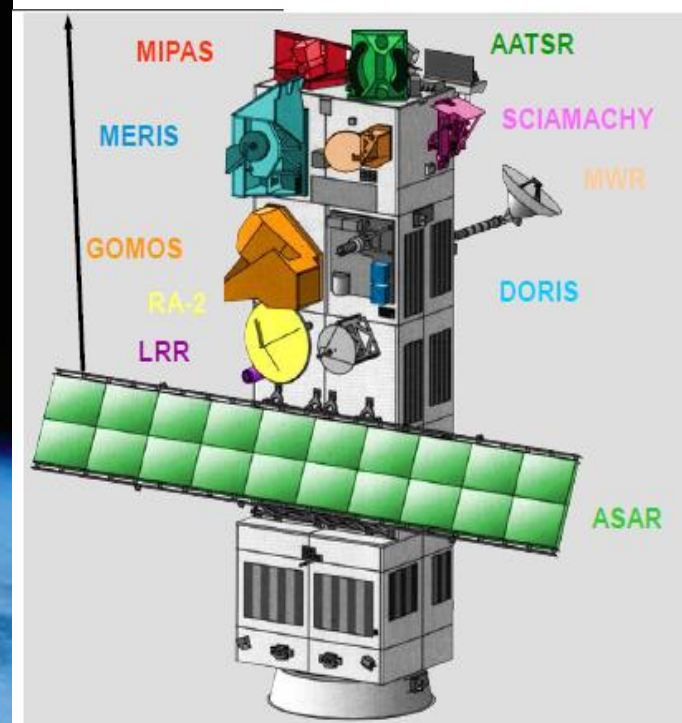

ASAR Operation Modes

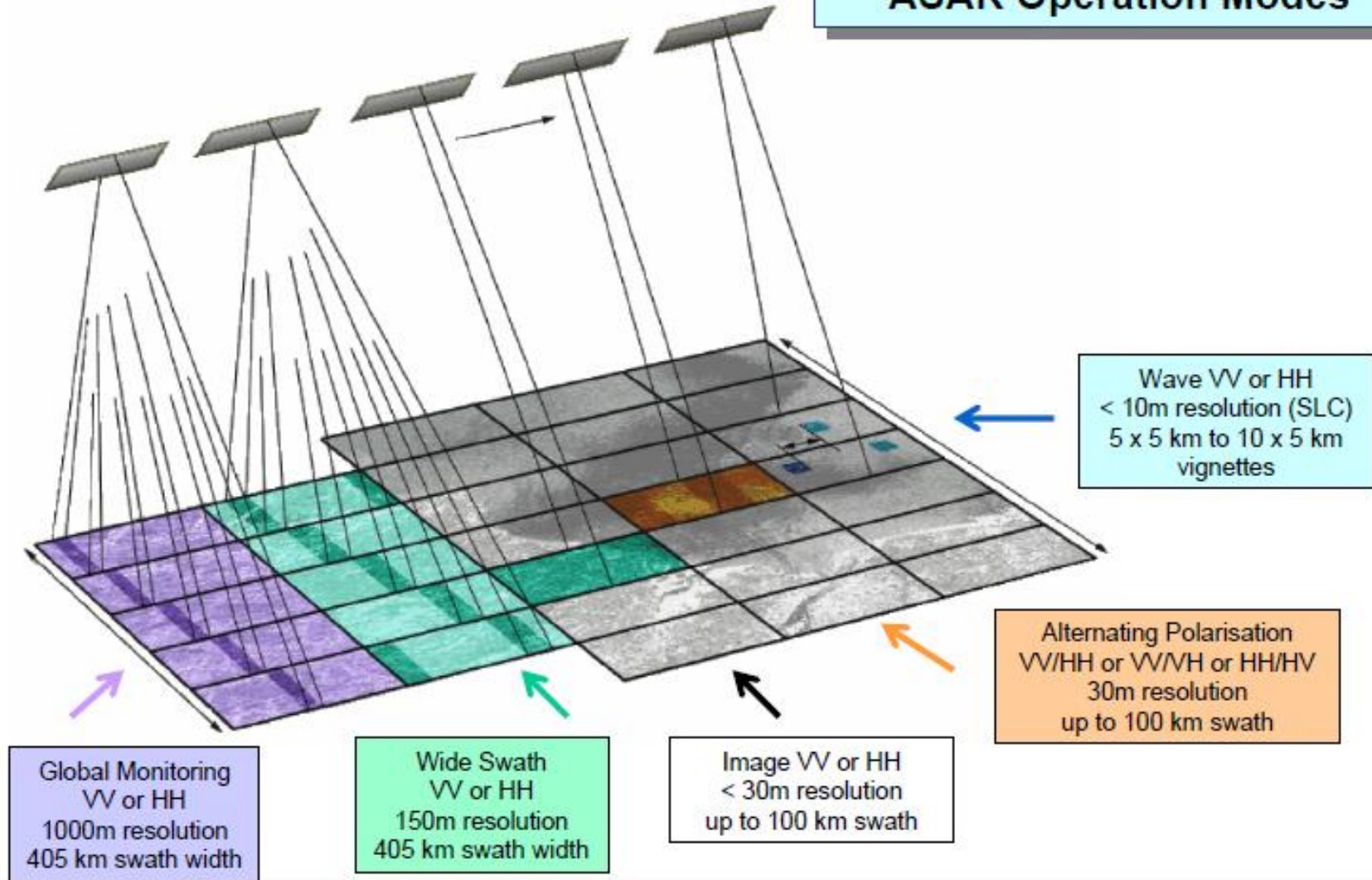



ENVISAT mission: 10 years

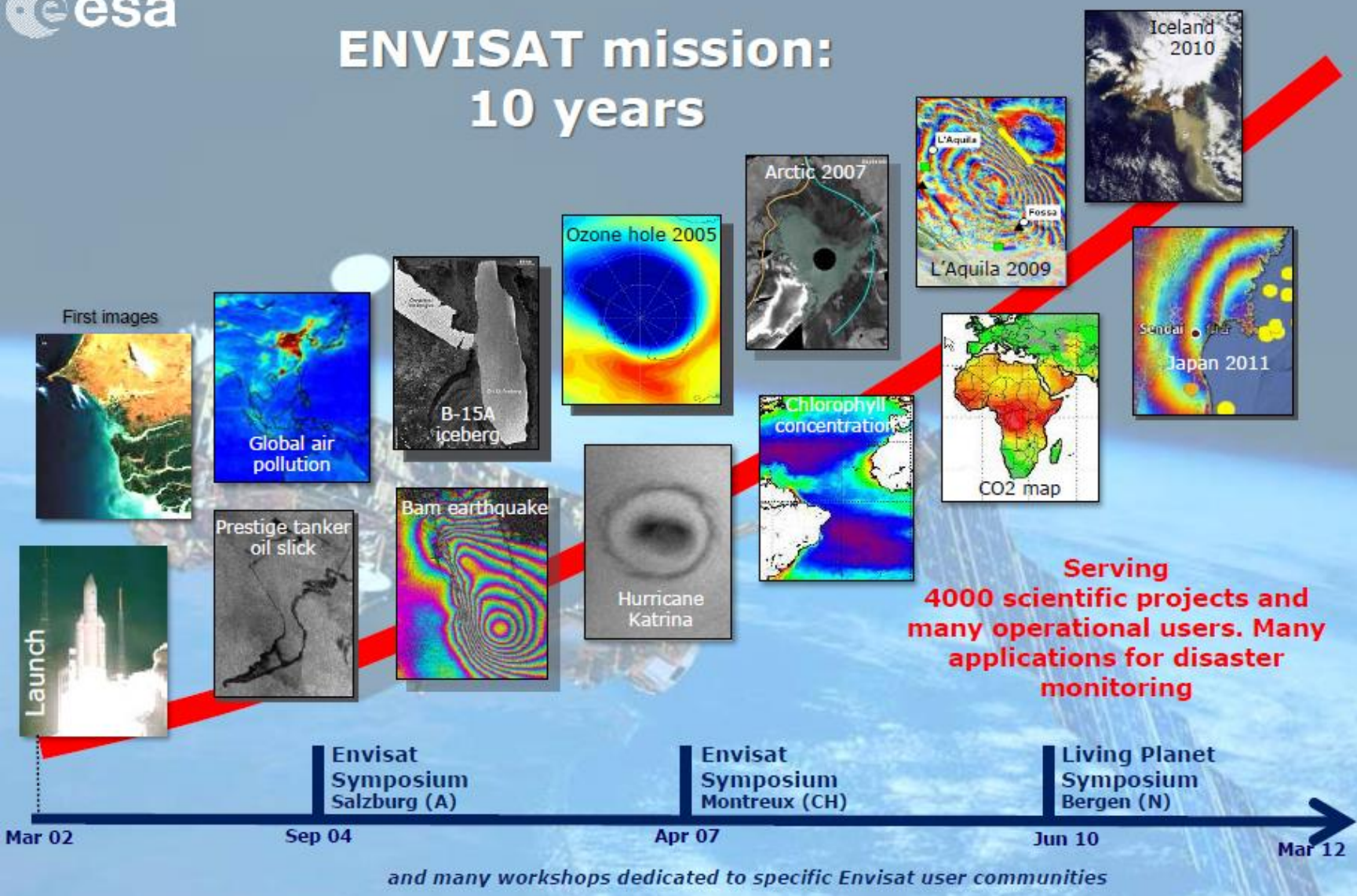



Launched in November 1995, **RADARSAT-1** provides Canada and the world with an operational radar satellite system capable of timely delivery of large amounts of data. Equipped with a powerful synthetic aperture radar (SAR) instrument, it acquires images of the Earth day or night, in all weather and through cloud cover, smoke and haze.

RADARSAT-2

Lançado em 2007

Resolução 3m

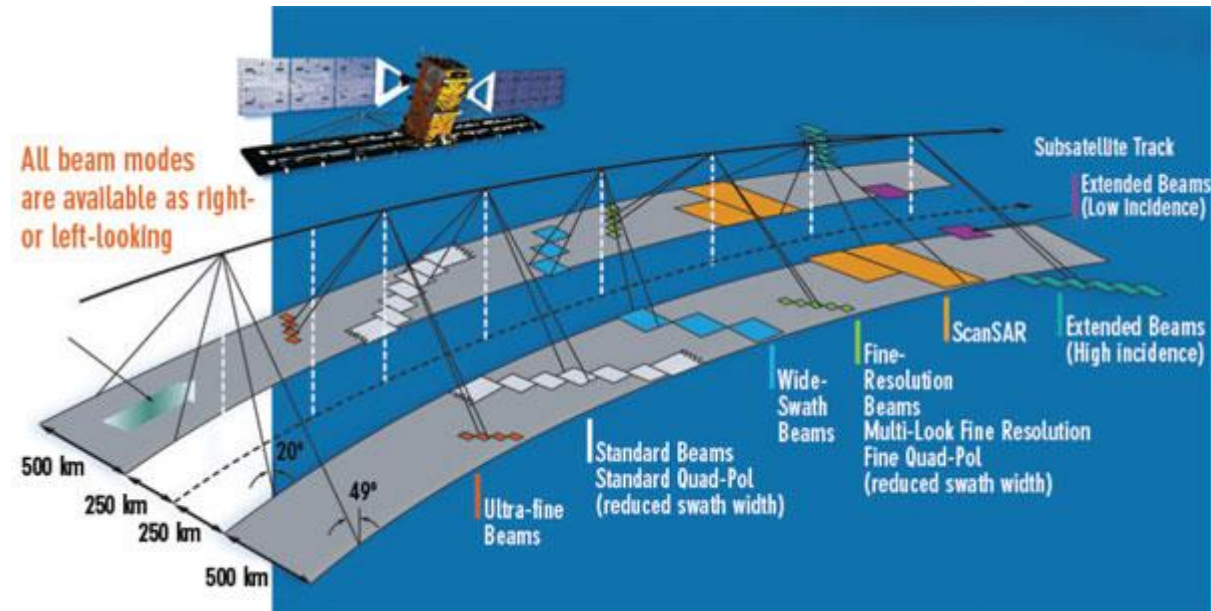

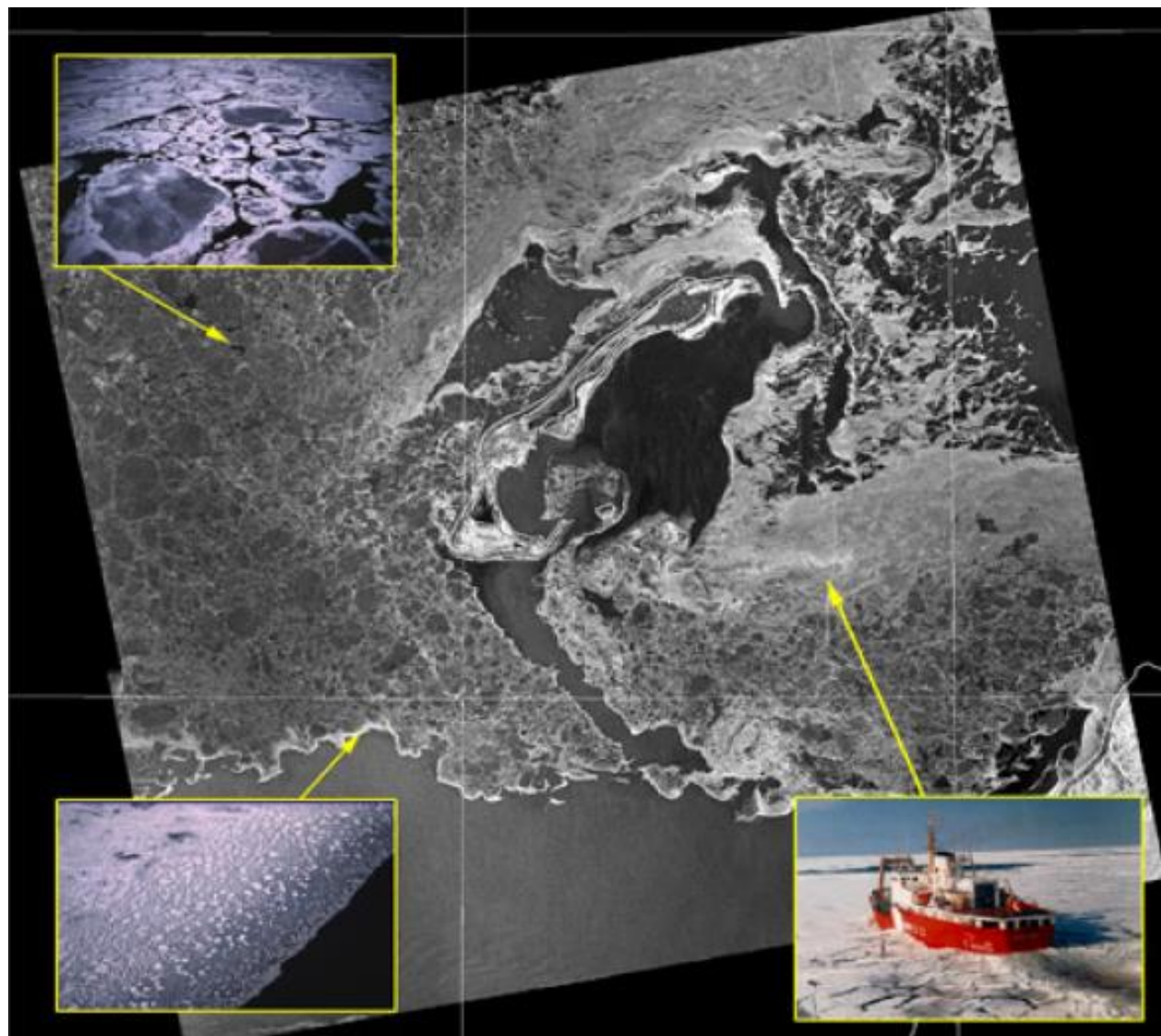

RADARSAT provides routine surveillance of the entire Arctic region.

This helps track sea ice distribution, identify various types of ice, and produce daily ice charts.

The information is used for planning safe shipping routes and supply operations for offshore exploration platforms or ocean research stations.

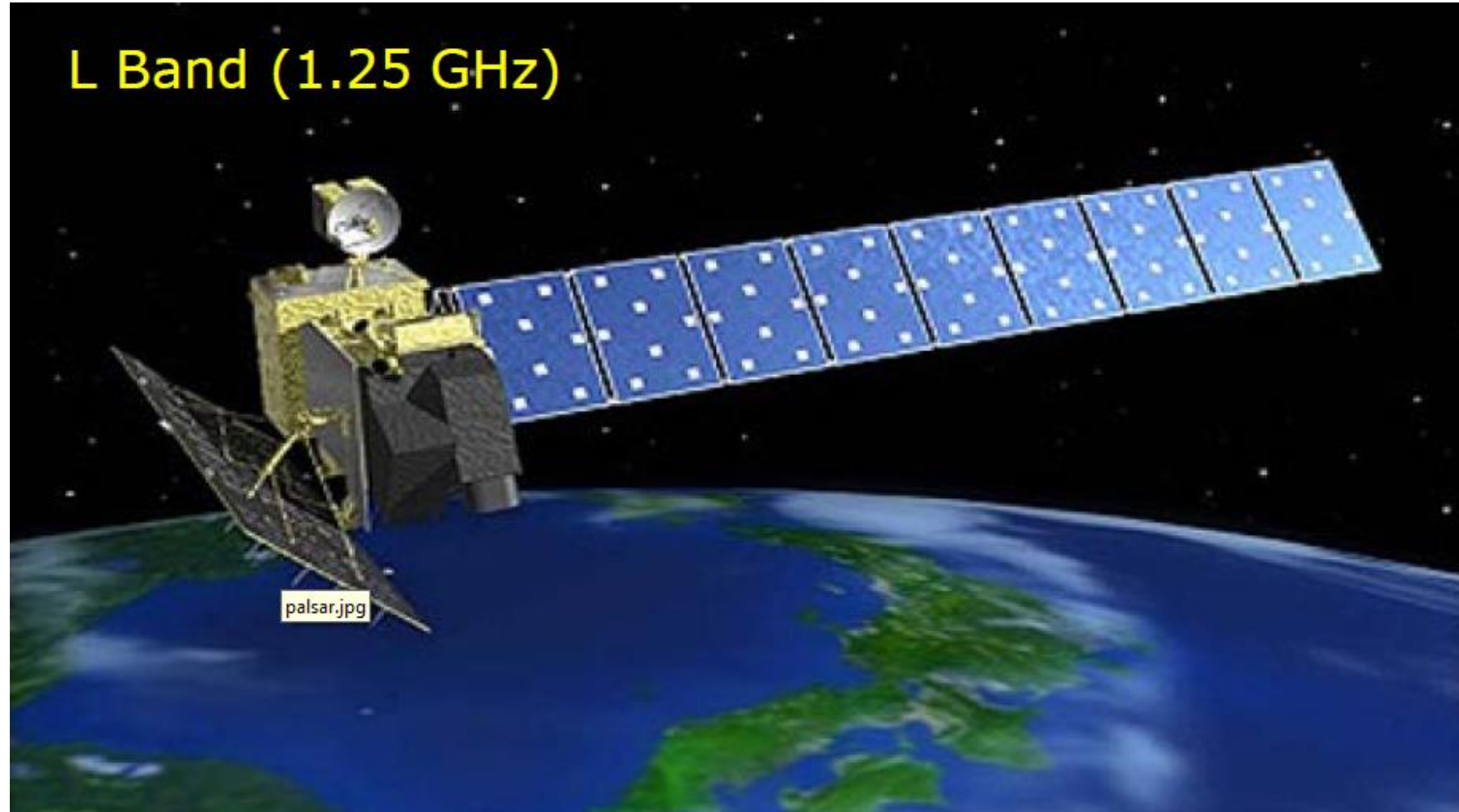

Lançado em 2006

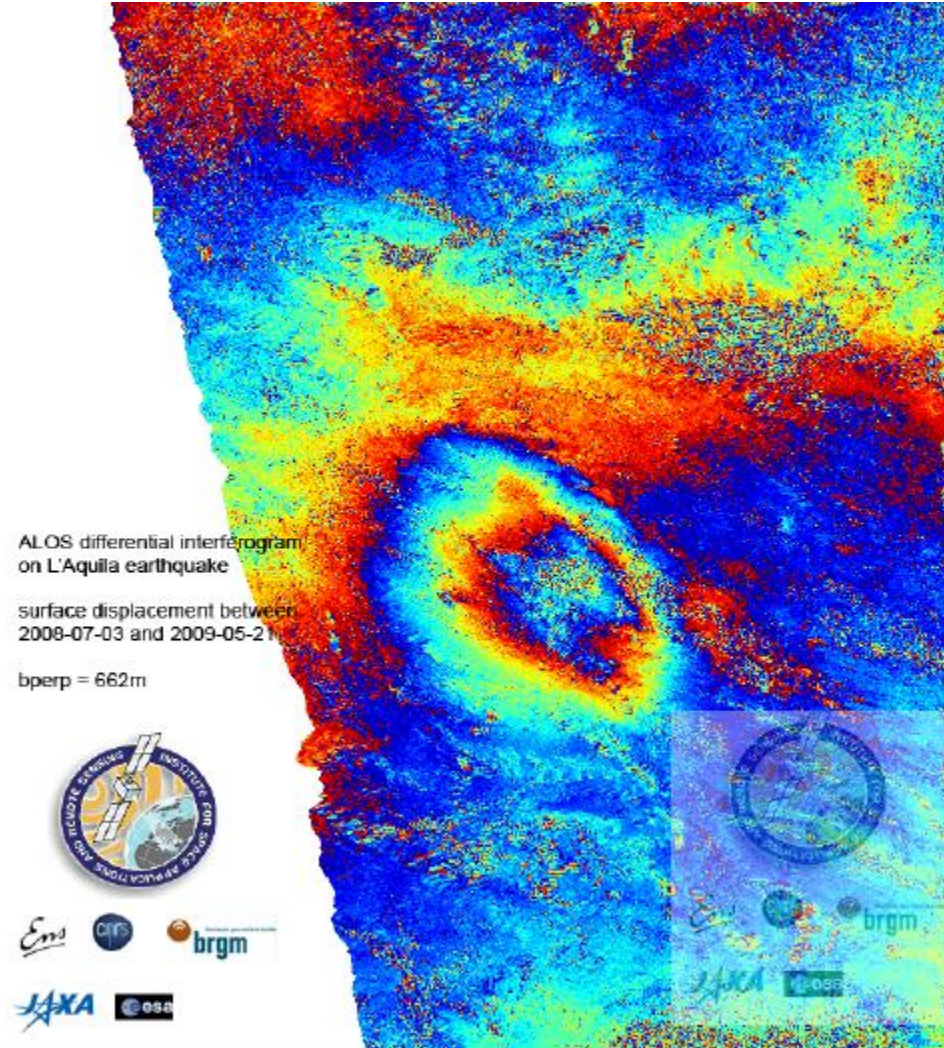
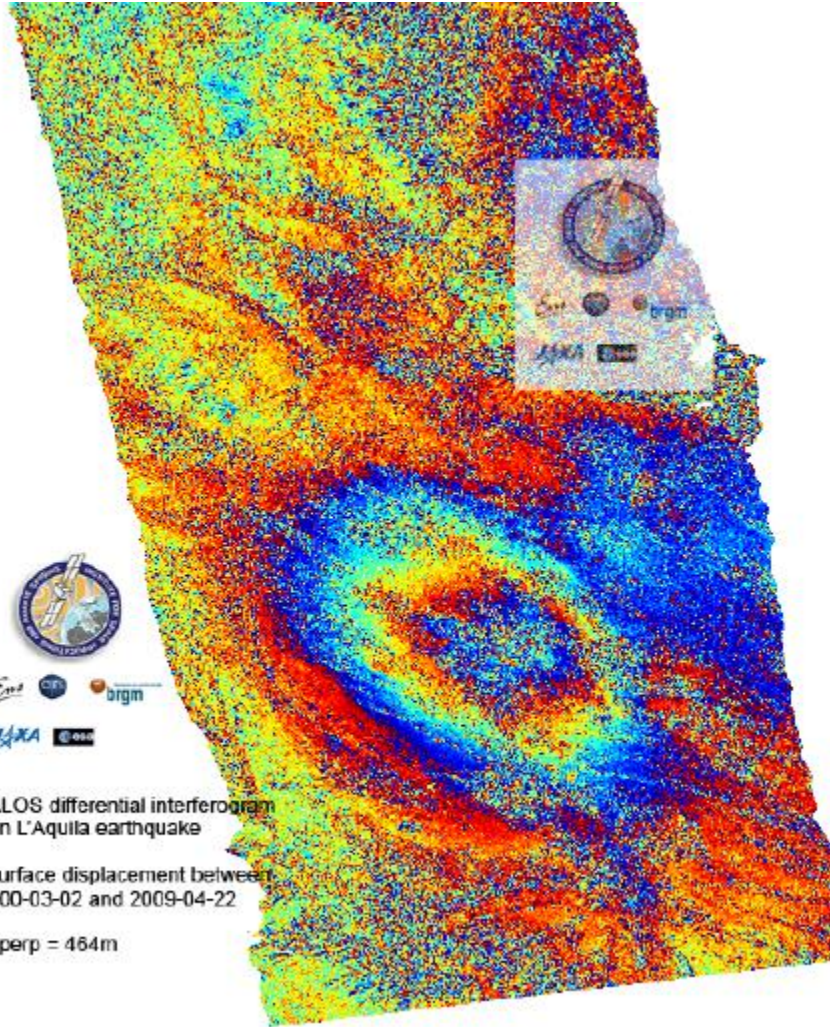

L'Aquila,
2009

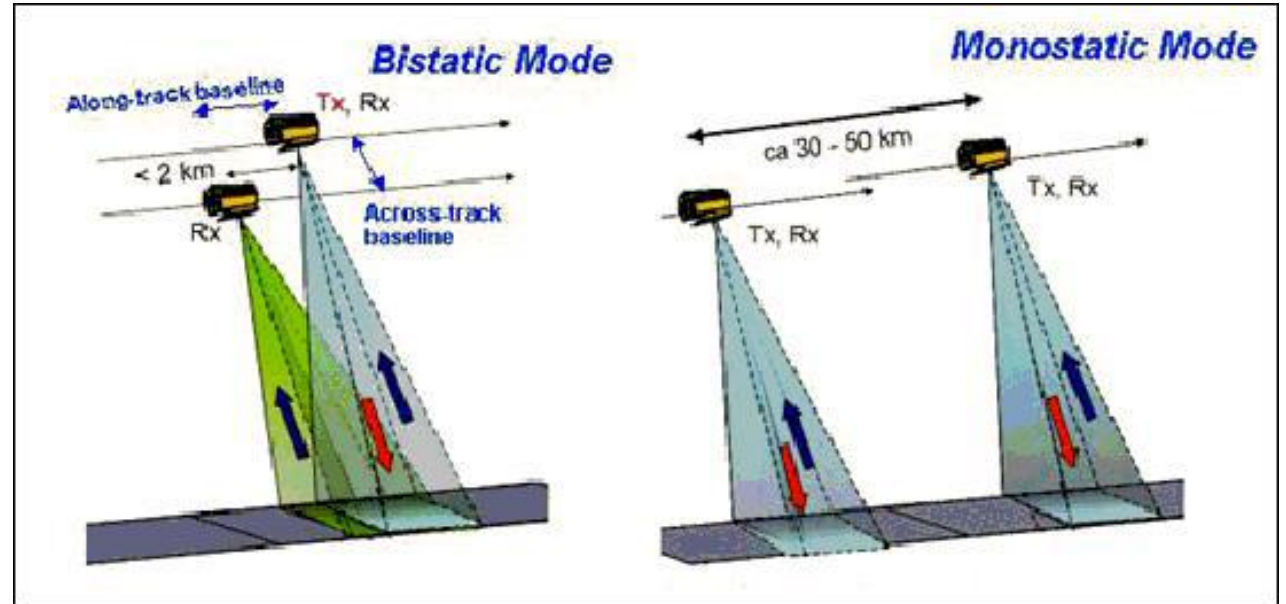

COSMO-SkyMed (CONstellation of small Satellites for the Mediterranean basin Observation) is an Earth observation satellite system funded by the Italian Ministry of Research and Ministry of Defense and conducted by the Italian Space Agency(ASI), intended for both military and civilian use.



- With 4 satellites up to 1800 images per day
Daily scenario example:
- 300 Spotlight-2 = 30,000 km² at 1m resolution
 - And
 - 1,500 Stripmap = 2,400,000 km² at 3m resolution

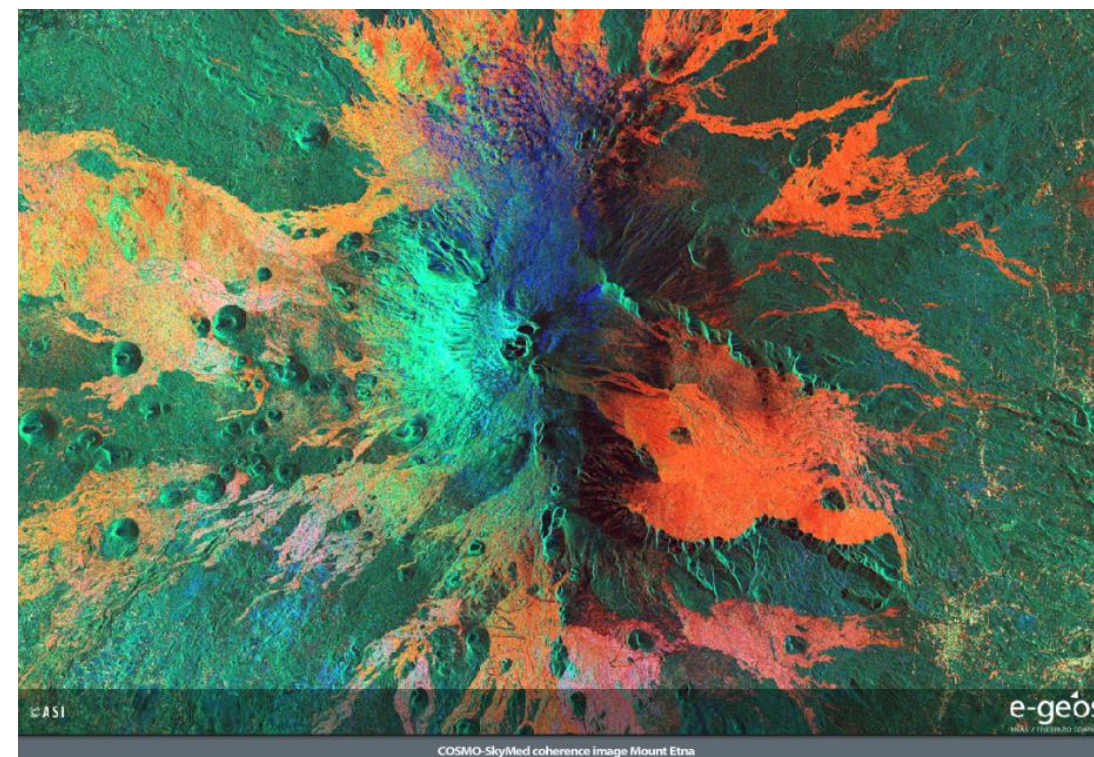



The NASA-ISRO SAR (NISAR) Mission will measure Earth's changing ecosystems, dynamic surfaces, and ice masses providing information about biomass, natural hazards, sea level rise, and groundwater, and will support a host of other applications.

NISAR will observe Earth's land and ice-covered surfaces globally with 12-day regularity on ascending and descending passes, sampling Earth on average every 6 days for a baseline 3-year mission.

Mission Characteristics

Orbit Altitude	747 km
Orbit Inclination	98.4°
Repeat Cycle	12 days
Time of Nodal Crossing	6 AM/ 6 PM
Orbit Control	< 500 m
Pointing Control	< 273 arcsec
Pointing	Left (south)
L/S Duty Cycle	> 50%/10%
Baseline Mission Duration	3 years
Consumables	5 years
Data and Product Access	Free & open
Wavelength	L-band: 24 cm S-band: 9 cm
SAR Resolution	3-10 m mode-dependent

SENTINEL-1

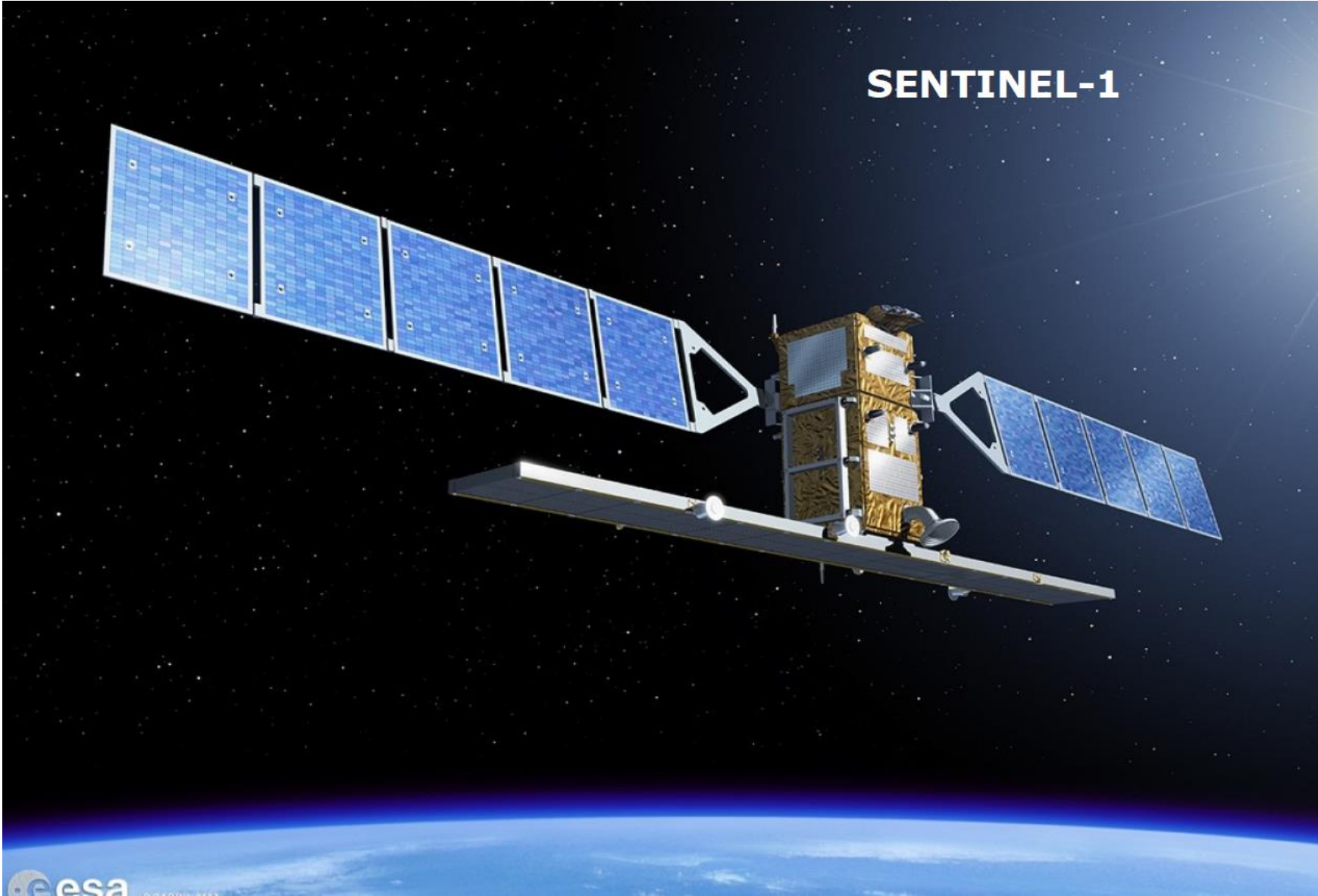

Sentinel-1 Mission Objectives



Provide routinely and systematically SAR data to GMES Services and National services:

- ✓ Marine Monitoring (e.g. oil spill, sea ice)
- ✓ Land Monitoring (e.g. land cover, surface deformation)
- ✓ Emergency Response
- ✓ Climate Change (e.g. Polar caps incl. ice shelves and glaciers)
- ✓ Security (e.g. vessel detection)

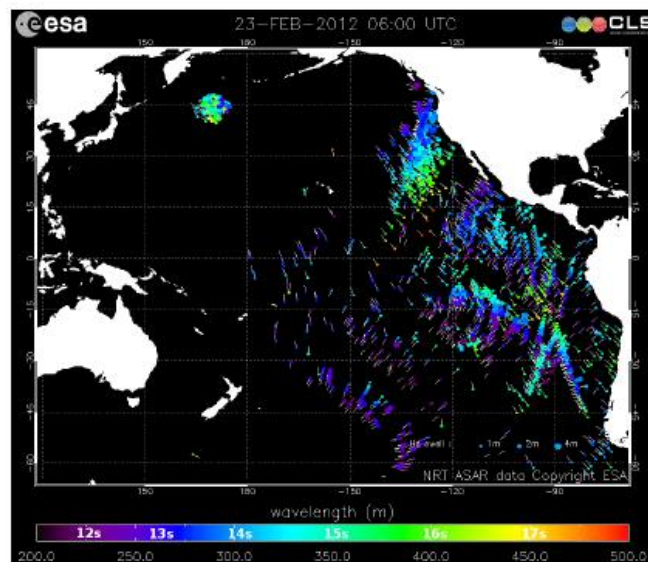
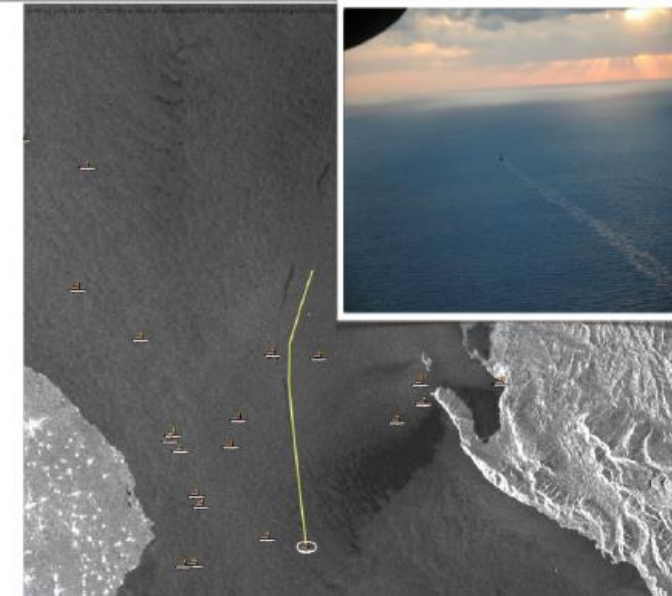

The Sentinel-1 mission is designed as a two-satellite constellation. The identical satellites orbit Earth 180° apart and at an altitude of almost 693 km. This configuration optimises coverage, offering a global revisit time of just six days.

At the equator, however, the repeat frequency is just three days and less than one day over the Arctic. Europe, Canada and main shipping routes are covered in less than three days.

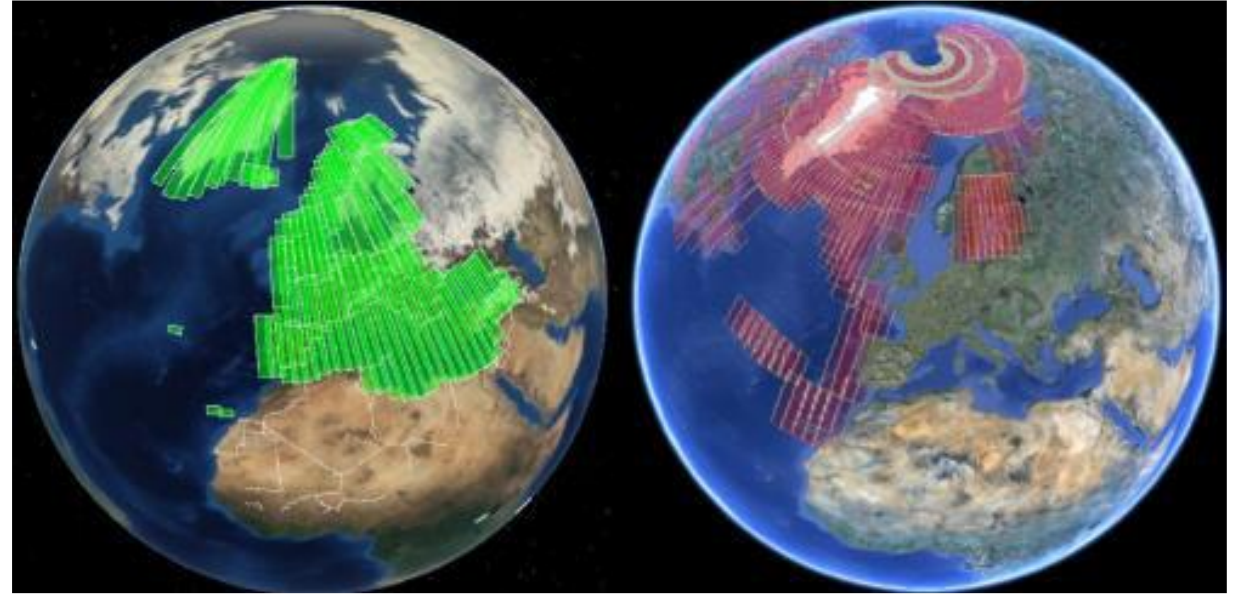

Left: Europe and European waters – IW mode, ascending orbits over a 12-day repeat cycle (January)

Right: Europe and European waters – EW mode, descending orbits over a 12-day repeat cycle (January)

Interferometric Wide swath (IW) and Extra Wide swath (EW) modes (400 km swath)

Sentinel-1 Technical Facts



- C-Band SAR instrument operates at centre frequency of 5.405 GHz
- On-board data storage capacity (mass memory) of 1400 Gbit
- Two X-band RF channels for data downlink with 2 X 260 Mbps
- On-board data compression using Flexible Dynamic Block Adaptive Quantization
- Optical Communication Payload for data transfer via laser link with the GEO European Data Relay Satellite (ERDS) system

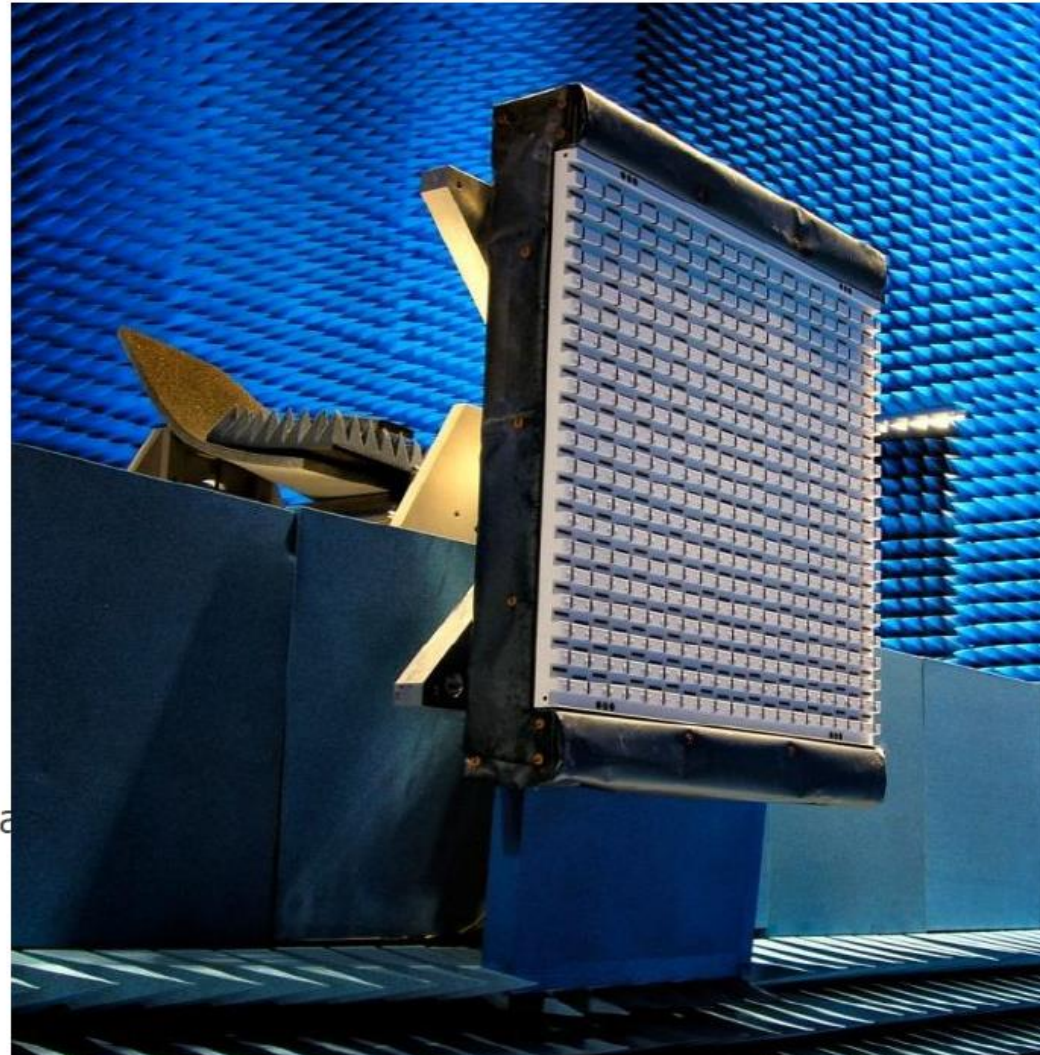

Sentinel-1 SAR Imaging Modes (1/3)



4 mutually exclusive SAR modes with different resolution and coverage

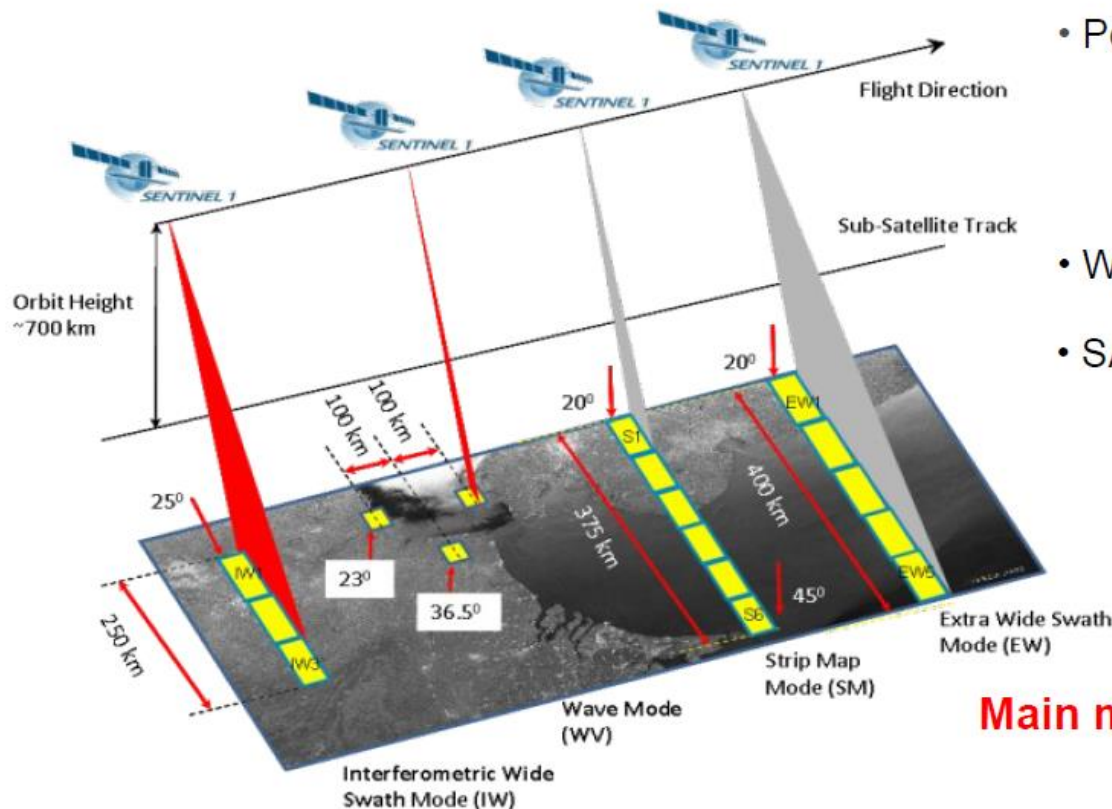

- Polarisation schemes for IW, EW & SM:
 - ✓ single polarisation: HH or VV
 - ✓ dual polarisation: HH+HV or VV+VH
- Wave mode: HH or VV
- SAR duty cycle per orbit:
 - ✓ up to 25 min in any of the imaging modes
 - ✓ up to 74 min in Wave mode

Main modes of operations: IW and WV

Visão Radar

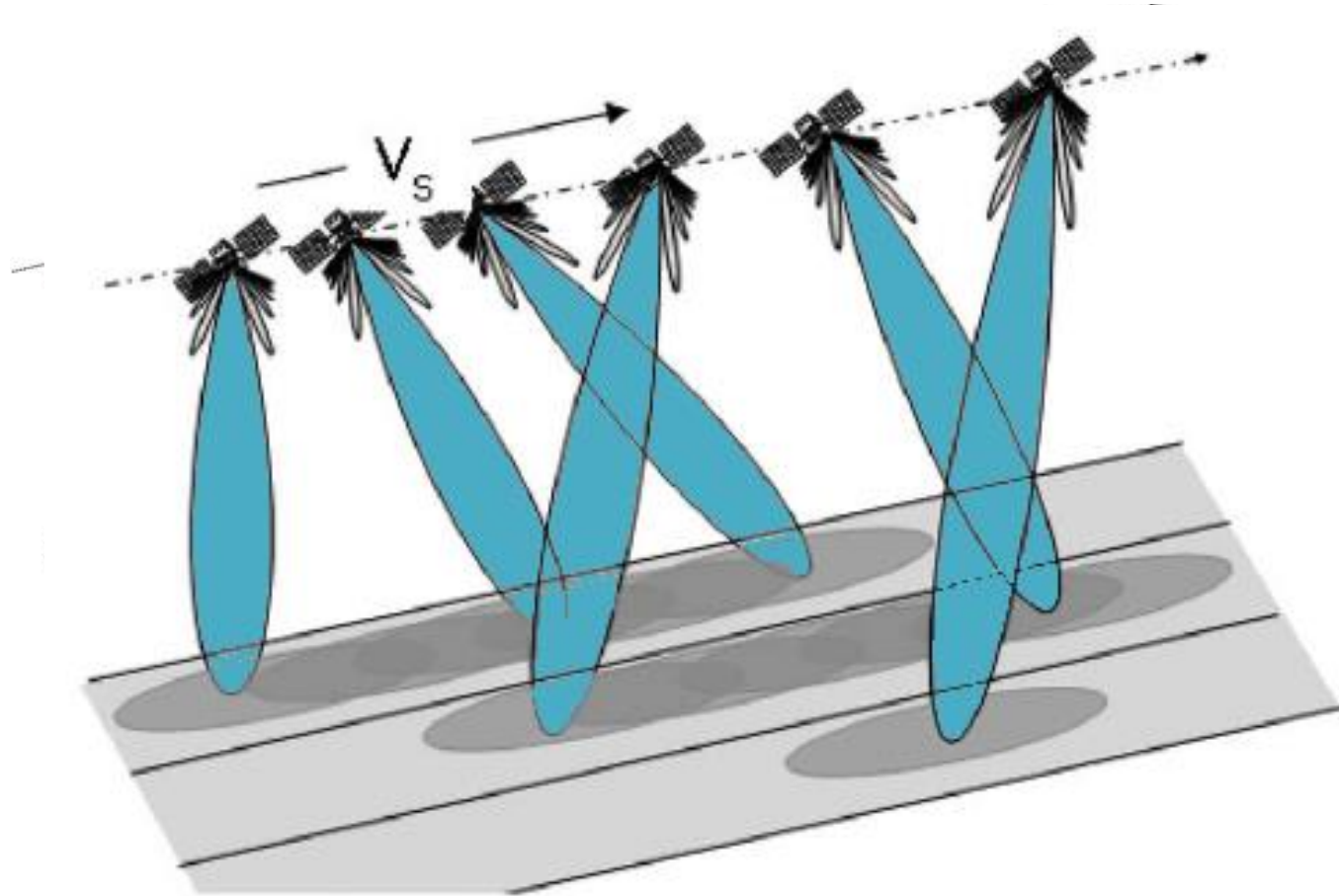

Interferometric Wide swath mode, the default mode over land, has a swath width of 250 km and a ground resolution of 5 x 20 m. (TOPSAR, burst)

Wave mode acquisitions – which can help to determine the direction, wavelength and heights of waves on the open oceans – are 20 x 20 km, acquired alternately on two different incidence angles every 100 km.

There's also the potential for operating it in two additional modes: Stripmap (5m x 5m) and Extra Wide Swath (20m x 40m).

Extra Wide-swath mode covers an ultra-wide-swath width of more than 400 km at medium resolution (20 x 40 m on the ground). (TOPSAR)

Sentinel-1 SAR Imaging Modes (3/3)



Mode	Access Angle	Single Look Resolution	Swath Width	Polarisation
Interferometric Wide Swath	> 25 deg.	Range 5 m Azimuth 20 m	> 250 km	HH+HV or VV+VH
Wave mode	23 deg. and 36.5 deg.	Range 5 m Azimuth 5 m	> 20 x 20 km Vignettes at 100 km intervals	HH or VV
Strip Map	20-45 deg.	Range 5 m Azimuth 5 m	> 80 km	HH+HV or VV+VH
Extra Wide Swath	> 20 deg.	Range 20 m Azimuth 40 m	> 400 km	HH+HV or VV+VH

Image Quality Parameters for all Modes (worst case)

Radiometric accuracy (3σ)	1 dB
Noise Equivalent Sigma Zero	-22 dB
Point Target Ambiguity Ratio	-25 dB
Distributed Target Ambiguity Ratio	-22 dB

Sentinel-1 observation scenario



High level strategy:

- optimum use of SAR duty cycle (25 min/orbit), taking into account the various constraints (e.g. limitation in the number of X-band RF switches, mode transition times)
- **Wave** Mode continuously operated over open oceans, with lower priority w.r.t. the other high rate modes
- IW or EW modes operated over pre-defined geographical areas:
 - **Over land**: pre-defined mode is **IWS**
 - **Over seas and polar areas, and ocean relevant areas**: pre-defined mode is either **IWS** or **EWS**
- In **exceptional** cases only, **emergency** observation requests may alter the pre-defined observation scenario, with e.g. the use of the Strip Map mode



SENTINEL-1A - OBSERVATION SCENARIO 28.01.2015 - 09.02.2016 (CYCLE 70)

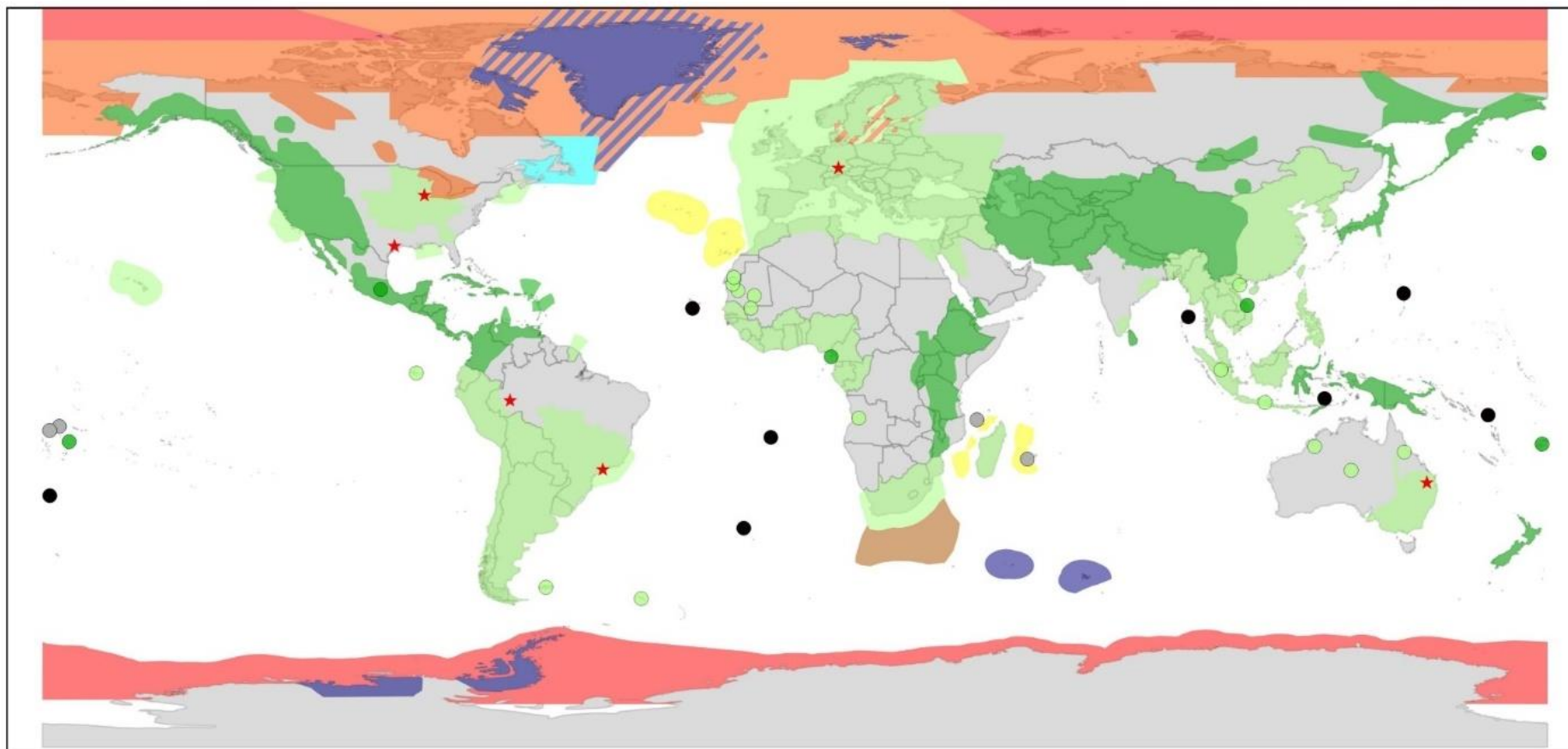

EW (HH)	EW (HH)	IW (HH)	IW (HH)	SM (HH)	CALIBRATION SITE
EW (HH-HV)	EW (HH-HV)	IW (HH-HV)	IW (HH-HV)	SM (HH-HV)	
EW (VV)	EW (VV)	IW (VV)	IW (VV)	SM (VV)	
EW (VV-VH)	EW (VV-VH)	IW (VV-VH)	IW (VV-VH)	SM (VV-VH)	

S-1 Product Family

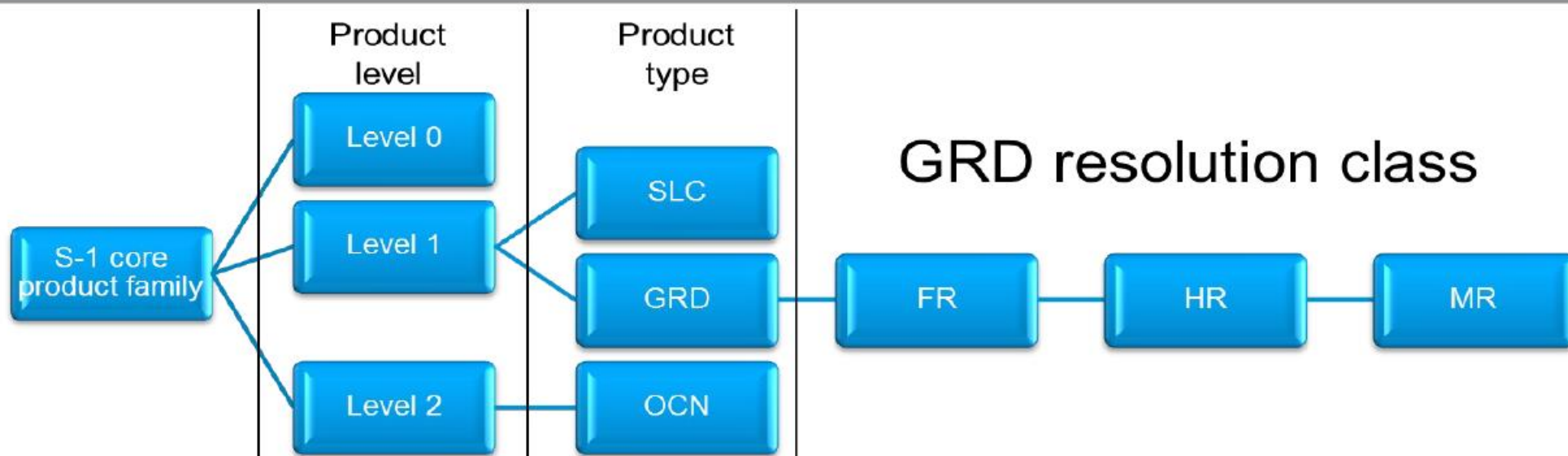

Acquisition Mode	L0/1/2	Product type	GRD_FR	GRD_HR	GRD_MR
SM	✓	✓	✓	✓	✓
IW	✓	✓		✓	✓
EW	✓	✓		✓	✓
WV	✓	✓			

S-1 Product Family



LEVEL-0 PRODUCTS

- (FD)BAQ encoded, unprocessed instrument source packets, with additional annotations and auxiliary information to support the processing

LEVEL-1 PRODUCTS

•**Slant-Range Single-Look Complex Products (SLC)**

- Focused data in slant-range geometry, single look with phase and amplitude information with complete geo-reference information

•**Ground Range Detected Products (GRD)**

- Focused data projected to ground range using an Earth ellipsoid model, detected and multi-looked. Original satellite path direction preserved and with complete geo-reference information.

Aplicações

Oceano e Gelo

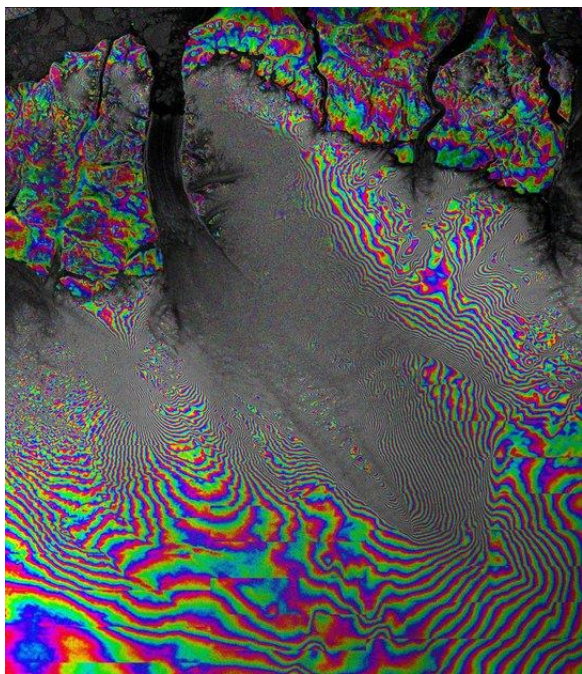

Changing lands

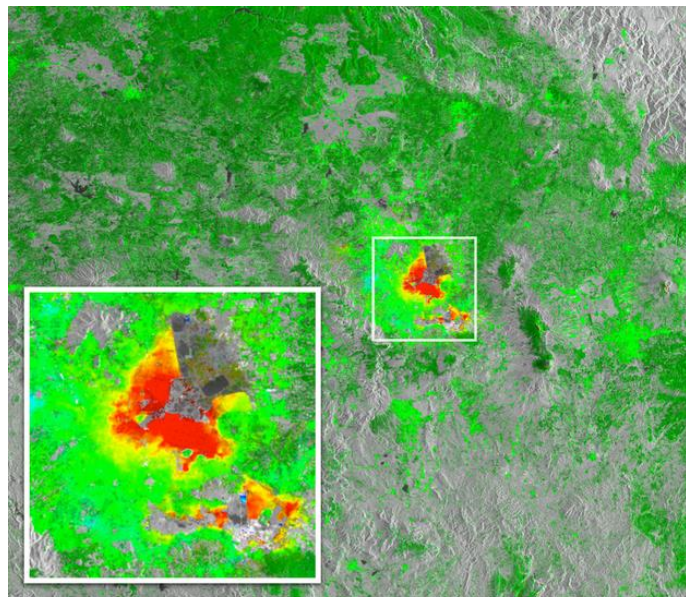

-20 cm/yr +20 cm/yr

Emergency response

