















Table of Contents

Chapter 1	Warning Symbols	1
Chapter 2	Brief Description	2
Chapter 3	Kit Components	3
	3.1. Mechanical Components.....	3
	3.2. Light Source and Collimation.....	4
	3.3. Optical Components.....	5
	3.4. Targets and Masks.....	7
	3.5. Hardware and Screws	8
Chapter 4	Theoretical Background.....	9
	4.1. Fourier Optics	9
	4.1.1. Basics of Fourier Transformation	9
	4.1.2. Kirchhoff's Diffraction Formula	9
	4.1.3. Fresnel Approximation/Diffraction	11
	4.1.4. Fraunhofer Approximation/Diffraction	11
	4.1.5. Link to Fourier Transformation	12
	4.1.6. The Lens as a Fourier Transformer	12
	4.1.7. Optical Filtering	15
	4.1.8. Misconceptions	22
	4.2. Microscope Fundamentals	24
	4.3. Köhler Illumination	26
	4.4. Optical Path of the Microscope	30
	4.5. Diffraction and Angular Resolution of the Microscope .	31
Chapter 5	Setup and Adjustment.....	35
	5.1. Assembly of the Components	35
	5.2. Camera Installation and Settings	45
	5.3. Target and Mask.....	48
	5.4. Setup and Adjustment of the Experiment	50
	5.5. Function of the Individual Optical Elements	64
Chapter 6	Exercises and Examples.....	66

6.1. Preliminary Tests	67
6.2. Introductory Tasks	70
6.3. Filtering	72
6.4. Babinet’s Principle	93
6.5. Image Editing.....	95
6.6. Inverse Fourier Target.....	98
6.7. Diffraction-Limited Resolution.....	100
Chapter 7 Condensed Setup Instructions	102
Chapter 8 Troubleshooting	103
Chapter 9 Ideas for Additional Experiments	104
9.1. Fourier Optics and Coherence.....	104
9.2. Quantitative Measurement.....	106
9.3. Measuring the Diffraction Pattern of a Single Slit.....	109
9.4. Spectrometer	109
9.5. Slide Projector.....	109
9.6. Darkfield Microscopy	109
Chapter 10 Matlab Code	111
Chapter 11 Acknowledgements.....	112
Chapter 12 Regulatory	113
Chapter 13 Thorlabs Worldwide Contacts.....	114

Chapter 1 Warning Symbols

Below is a list of warning symbols you may encounter in this manual or on your device.

Symbol	Description
	Direct Current
	Alternating Current
	Both Direct and Alternating Current
	Earth Ground Terminal
	Protective Conductor Terminal
	Frame or Chassis Terminal
	Equipotentiality
	On (Supply)
	Off (Supply)
	In Position of a Bi-Stable Push Control
	Out Position of a Bi-Stable Push Control
	Caution: Risk of Electric Shock
	Caution: Hot Surface
	Caution: Risk of Danger
	Warning: Laser Radiation

Chapter 2 Brief Description

“The microscope image is the interference effect of a diffraction phenomenon.”

This quote attributed to Ernst Abbe condenses the rich amount of effects that can be found when dealing with Fourier optics. Three major aspects directly follow from Abbe's sentence:

- In a microscope, light is diffracted by the sample. The diffracted light is collected by a lens, interferes and, thereby, forms the microscope image.
- Manipulating the light that is diffracted by the sample automatically results in a change of the corresponding image of that structure. This is what we know as *Fourier Optics*.
- When the microscope cannot catch more than the zeroth diffraction order from the sample, then no information about the sample is collected by the lens that maps the light on the camera or screen. This immediately makes clear how structures smaller than a certain wavelength cannot be observed with classical light microscopes. For those cases, there are no diffraction orders left to interfere and to form the image.

These three aspects are investigated experimentally in this kit. The first aspect is examined by building a horizontal microscope and investigating the image formation in it. In the context of Fourier optics, this would be referred to as a "4f" setup. For illumination, a white LED with a color filter is used. This shows that the experiments do not require laser light but instead occur with "normal" light sources as well.

The majority of this kit focuses on the second aspect. Various microstructures are placed in the object plane of the microscope. In the back focal plane of the objective lens, the Fraunhofer diffraction pattern is found. Since it is essentially the Fourier transform of the structure, the plane is denoted as the Fourier plane. Manipulating this plane with different methods (variable slit, iris, dots, and other masks) yields manipulated images. In the kit, we figuratively open the door of the Fourier house and free a smiley from prison. From here, the line is drawn towards modern image enhancement and image correction. The kit also features a demonstration of Babinet's Principle and includes a sample that generates an image in the Fourier plane.

Finally, the third aspect is shown by demonstrating that the zeroth diffraction order does not carry information about the sample. This directly leads to Abbe's fundamental diffraction limit of imaging.

Chapter 3 Kit Components

In cases where the metric and imperial kits contain parts with different item numbers, metric part numbers and measurements are indicated by parentheses unless otherwise noted.

3.1. Mechanical Components

 <p>1 x MB648 (MB15120/M) Aluminum Breadboard, 6" x 48" (15 cm x 120 cm)</p>	 <p>2 x RDF1 Rubber Damping Feet, Set of Four</p>	 <p>11 x PH2 (PH50/M) Ø1/2" (Ø12.7 mm) Post Holder, 2" (50 mm) Long</p>
 <p>11 x BE1(/M) Ø1.25" (Ø31.8 mm) Pedestal Base Adapter</p>	 <p>13 x CF125 Clamping Fork</p>	 <p>13 x TR2 (TR50/M) Ø1/2" (Ø12.7 mm) Post, 2" (50 mm) Long</p>
 <p>1 x EDU-VS1(/M) Viewing Screen</p>	 <p>1 x TR1.5 (TR30/M) Ø1/2" (Ø12.7 mm) Post, 1.5" (30 mm) Long</p>	 <p>1 x BA2(/M) Mounting Base, 2" x 3" x 3/8" (50 mm x 75 mm x 10 mm)</p>
 <p>1 x PH1.5 (PH30/M) Ø1/2" (Ø12.7 mm) Post Holder, 1.5" (30 mm) Long</p>	 <p>4 x PH2E (PH50E/M) Ø1/2" (Ø12.7 mm) Pedestal Post Holder, 2" (50 mm) Long</p>	

3.2. Light Source and Collimation

 <p>1 x Cold White LED, 1300 mA¹ Max</p>	 <p>1 x LEDD1B LED Driver, 1200 mA Max</p>	 <p>1 x KPS101 Power Supply, 15 V, 2.4 A</p>
 <p>1 x SM1RC(M) Ø1.20" (Ø30.5 mm) Slip Ring</p>	 <p>1 x SM1V10 Ø1" Adjustable Lens Tube, 0.81" Travel Range</p>	 <p>1 x ACL2520U-A Ø25 mm Aspheric Condenser Lens, f = 20.1 mm</p>
 <p>1 x SM1RRC Extra-Thick SM1 (1.035"-40) Retaining Ring</p>		

¹ Please note that the LED is rated RG2 in the risk group classification, according to the standard IEC 62461:2006, Photobiological safety of Lamps and Lamp Systems. RG2 = Moderate Risk Group.

3.3. Optical Components

 <p>1 x TRF90(/M) 90° Flip Mount</p>	 <p>1 x FB550-40 Ø1" Bandpass Filter, 550 nm, FWHM 40 nm</p>	 <p>4 x LMR1(/M) Ø1" Lens Mount</p>
 <p>2 x ID12(/M) Iris, 12 mm Max Aperture, on TR3 (TR75/M) Post</p>	 <p>1 x ID25(/M) Iris, 25 mm Max Aperture, on TR3 (TR75/M) Post</p>	 <p>2 x AC254-150-A Ø1" Achromatic Doublet, f = 150 mm</p>
 <p>1 x SM1L05 Ø1" Lens Tube, 1/2" Long</p>	 <p>1 x AC254-050-A Ø1" Achromatic Doublet, f = 50 mm</p>	 <p>1 x SM1ZM SM1 Zoom Housing for Ø1" Optics, 4.1 mm Travel</p>
 <p>1 x AC254-030-A Ø1" Achromatic Doublet, f = 30 mm</p>	 <p>1 x KCP05(/M) Optic Mount Centering Plate</p>	 <p>1 x BS028 Beamsplitter Cube, 90:10 (Reflection:Transmission)</p>

 <p>1 x CCM1-4ER(/M) Housing for Beamsplitter Cube</p>	 <p>1 x CS165CU(/M) CMOS Color Camera, 1440 x 1080 Pixels</p>	 <p>1 x SM1L30 Ø1" Lens Tube, 3" Long</p>
 <p>1 x SM1EC2B Snap-On Plastic Dust Caps for SM1 Lens Tubes, 5 Pack</p>	 <p>1 x LB1901 Ø1" N-BK7 Bi-Convex Lens, f = 75.0 mm</p>	 <p>1 x LMR1AP Alignment Plate for Ø1" Fixed Optic Mounts</p>
 <p>1 x SMR1(/M) Ø1" Lens Mount without Retaining Lip</p>		

3.4. Targets and Masks



2 x **XYF1(M)**
XY Mount for 1" to 3"
Rectangular Optics

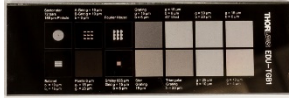

1 x **EDU-TGB1**
Micro-Structured Target,
Chrome on Glass, OD3



1 x **VA100(M)**
Adjustable Mechanical Slit



1 x **RSP1D(M)**
Rotation Mount for $\varnothing 1"$
Optic with Adjustable Zero



1 x **SM1A6**
Threaded Adapter, Internal
SM05 to External SM1



1 x **SM05T2**
Threaded Adapter,
External SM05 to
External SM05



1 x **EDU-TGC1**
Micro-Structured Masks,
Chrome on Glass, OD6

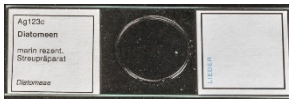

1 x **Diatoms Slide**



1 x **FP01**
Plate Holder



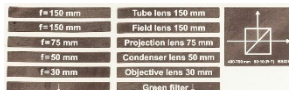

1 x **Inverse Fourier Target**



1 x **Set of Labels**

3.5. Hardware and Screws

 <p>1 x SPW606 SM1 Spanner Wrench, 1" (25.4 mm) long</p>	 <p>1 x Ruler, 12" (30 cm)</p>
--	--

Imperial Kit

Type	Number	Hex Keys: 0.035", 5/64", 9/64"
8-32 x 1/4" Cap Screw	2	
1/4"-20 x 3/8" Cap Screw	16	
1/4"-20 x 1/2" Cap Screw	8	 <p>1 x BD-3/16 Balldriver for 1/4"-20 Cap Screws</p>
1/4"-20 x 1/2" Setscrew	1	
1/4"-20 x 5/8" Cap Screw	2	
1/4" Washer	17	

Metric Kit

Type	Number	Hex Keys: 0.9 mm, 2 mm, 3 mm
M4 x 6 mm Cap Screw	2	
M6 x 10 mm Cap Screw	16	 <p>1 x BD-5M Balldriver for M6 Cap Screws</p>
M6 x 12 mm Cap Screw	8	
M6 x 12 mm Setscrew	1	
M6 x 16 mm Cap Screw	2	
M6 Washer	17	

Chapter 4 Theoretical Background

In this kit, we demonstrate Fourier optics and investigate the resulting influence on the microscope image. Consequently, this section first describes the theoretical background of Fourier optics. This is followed by a brief description of the microscope. Finally, how diffraction and the numerical aperture influence the resolving capacity of the microscope is illustrated.

4.1. Fourier Optics

For the purpose of this test kit, we assume that the reader has already been introduced to diffraction, for example at a slit and on a lattice. At a basic level, diffraction patterns are often explained as the interference of waves originating at each slit. To understand Fourier optics, however, this knowledge needs to be expanded to include the diffraction formula.

We begin with a brief note on Fourier transformations. An introduction of the diffraction formula and the transition to Fourier optics follows. We then illustrate why a lens is used as a Fourier transformer and how this relates to optical filtering and image editing.

4.1.1. Basics of Fourier Transformation

A two-dimensional Fourier transformation F of function f is presented as

$$F(u, v) = \int_{-\infty}^{\infty} \int_{-\infty}^{\infty} f(x, y) \cdot e^{-i2\pi(ux+vy)} dx dy \quad (1)$$

$$f(x, y) = \int_{-\infty}^{\infty} \int_{-\infty}^{\infty} F(u, v) \cdot e^{i2\pi(ux+vy)} du dv \quad (2)$$

When the Fourier transformation is applied again to $F(u, v)$, this results in the initial function $f(-x, -y)$ with reversed leading signs. The variables x and u as well as y and v are Fourier conjugated variables with a dimensionless product.

4.1.2. Kirchhoff's Diffraction Formula

As previously mentioned, we now want to look at diffraction in a very general formulation known as the diffraction formula.²

The examination begins with an opening of any shape σ in an otherwise opaque screen at $z = 0$, as shown in Figure 1(a).

² The discussion of the diffraction formula follows the presentation in Demtröder: *Experimentalphysik 2*, Springer, 2013. Other books that cover the contents of this theory chapter are *Eugene Hecht: Optics, 1st Edition* (chapter 10 covers diffraction and chapter 11 covers Fourier optics) as well as *Joseph W. Goodman: Introduction to Fourier Optics*.

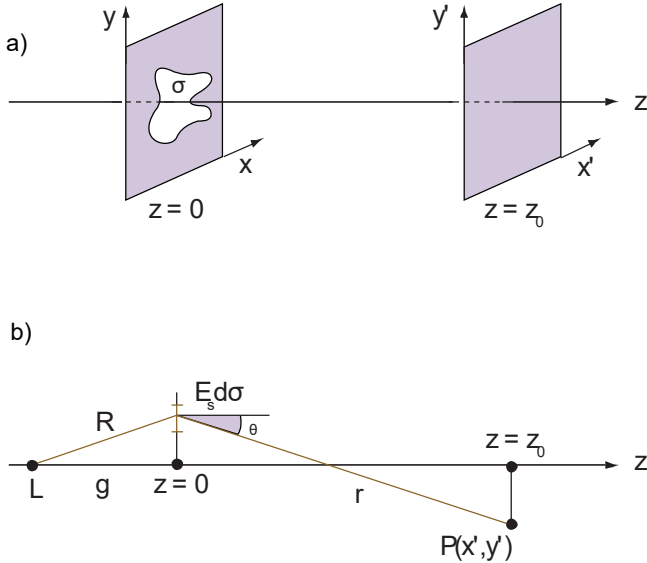

Figure 1: (a) Screen with Arbitrary Opening and (b) Side View with Source at L

In addition to this plane, there is a point light source at the point $L = (0, 0, -g)$. When we assume that it emits a spherical wave with the amplitude A , then the field distribution E_s in the plane $z = 0$ is given by

$$E(x, y, 0) = \frac{A}{R} e^{i(kR - \omega t)} \tag{3}$$

where $R = \sqrt{g^2 + x^2 + y^2}$ [see Figure 1(b)] and k is the wave number. Note that this case implicitly includes a plane wave traveling in the z -direction: when the point source is very far away from the plane $z = 0$, then the amplitude across the entire opening is approximately identical.

Now the question is how this field distribution on the opening σ translates to a field distribution in any plane behind the screen. We use Huygens' Principle to determine this, assuming that each infinitesimal surface element $d\sigma$ in the opening itself is again the source for an elementary wave. The contribution to the amplitude at point $P(x', y', z_0)$ by $d\sigma(x, y)$ is then

$$dE(x', y', z_0) = C \cdot \frac{E(x, y, 0) \cdot d\sigma(x, y)}{r} e^{ikr} \tag{4}$$

This is because the contribution must be proportional to the field strength at location $(x, y, 0)$ (since the new elementary wave emanates from here) and also proportional to the surface element $d\sigma$ since doubling the area would double the amplitude at point P . The term $\exp(ikr)/r$ is the propagation typical for spherical waves and C is a proportionality factor. With some effort, it is possible to show that it is given by $C = i \cdot \cos \theta / \lambda$ where $\cos \theta = z_0/r$.

To now obtain the total amplitude at point P , we can either integrate via the area σ or directly via all x and y in the area of $z = 0$, since the remaining parts of the screen except for σ make no contribution anyway. Therefore the field at point P is

$$E(x', y', z_0) = \iint i \cdot \frac{\cos \theta}{\lambda} \cdot \frac{E(x, y, 0)}{r} e^{ikr} dx dy \quad (5)$$

where we used $d\sigma = dx \cdot dy$. The integral in equation (5) is called the *Kirchhoff's diffraction formula*.

Now two subsequent approximations can be used to simplify and solve this formula. The first approximation (Fresnel) still encompasses a broad range of applications and describes both the near and far field behind the opening σ although it is most commonly used for the near field. The second approximation (Fraunhofer) only describes the field for very large distances between $z = 0$ and $z = z_0$ as well as small aperture diameters.

4.1.3. Fresnel Approximation/Diffraction

Let us begin with the first approximation. First we perform a Taylor expansion of r up to and including the second term:

$$r = \sqrt{z_0^2 + (x - x')^2 + (y - y')^2} \approx z_0 \left(1 + \frac{(x - x')^2}{2z_0^2} + \frac{(y - y')^2}{2z_0^2} \right) \quad (6)$$

In the denominator of equation (5) we can even use the approximation $r \approx z_0$ with $x/z_0 \ll 1$, $y/z_0 \ll 1$. This is not meaningful in the exponent since it is much more sensitive to changes of r – hence the expansion to the second term.

Furthermore, a good approximation of $\cos \theta = z_0/r$ is then 1. When everything is inserted into equation (5) then you get

$$E(x', y', z_0) = i \frac{e^{ikz_0}}{\lambda z_0} \iint E(x, y, 0) \cdot \exp\left(\frac{ik}{2z_0}((x - x')^2 + (y - y')^2)\right) dx dy \quad (7)$$

This is the Fresnel approximation of the diffraction formula.

Note: The Fresnel diffraction can be readily observed in this setup. To do so, simply move the objective lens slightly away from the object in the adjusted setup (by means of the variable lens tube). In this orientation, the light distribution close behind the object, which is the Fresnel diffraction pattern, is detected by the camera.

4.1.4. Fraunhofer Approximation/Diffraction

Let us go a step further and assume that the diameter of the diffracting opening σ is very small compared to z_0 . Insofar as

$$z_0 \gg \frac{1}{\lambda}(x^2 + y^2) \quad (8)$$

applies, we can further simplify the approximation in equation (6) by disregarding the expressions with x^2/z_0^2 and y^2/z_0^2 . This results in

$$r \approx z_0 \left(1 - \frac{xx'}{z_0^2} - \frac{yy'}{z_0^2} + \frac{x'^2 + y'^2}{2z_0^2} \right) \quad (9)$$

This simplifies the expression in the integral in particular and we obtain

$$E(x', y', z_0) = i \frac{e^{ikz_0}}{\lambda z_0} \exp\left(\frac{i\pi}{\lambda z_0}(x'^2 + y'^2)\right) \cdot \iint E(x, y, 0) \cdot \exp\left(-\frac{ik}{z_0}(x'x + y'y)\right) dx dy \quad (10)$$

as the Fraunhofer approximation of the diffraction formula.

4.1.5. Link to Fourier Transformation

There is a remarkable link between the Fraunhofer diffraction pattern and the Fourier transformation of the diaphragm. This is the basis of the test kit presented here.

Let us now assume that we are again looking at an area σ in an otherwise opaque plane as above. Let the field strength distribution in the opening be $E_e(x, y)$. With the window function $\tau(x, y)$ that has the value 1 for values within σ and the value 0 for values outside σ , the field in the entire plane $z = 0$ can be written as $E(x, y) = \tau(x, y) \cdot E_e(x, y, 0)$.

When we follow equation (10), the resulting Fraunhofer diffraction pattern in the plane $z = z_0$ is

$$E(x', y', z_0) = i \frac{e^{ikz_0}}{\lambda z_0} \exp\left(\frac{i\pi}{\lambda z_0}(x'^2 + y'^2)\right) \cdot \iint E_e(x, y, 0) \cdot \tau(x, y) \cdot \exp\left(-\frac{ik}{z_0}(x'x + y'y)\right) dx dy \quad (11)$$

When one compares the expressions in the integral of (11) and (1), one notes that (11) mainly contains the Fourier transformation of the field strength distribution.

This constitutes one of the essential diffraction theory insights: the Fraunhofer diffraction pattern (aside from the pre-factors) is derived directly from the Fourier transformation of the opening.

4.1.6. The Lens as a Fourier Transformer

So far we have shown how to calculate the field distribution behind an aperture of any form. Now we want to know what the field distribution behind a lens looks like.

For this purpose we first look at a circular aperture, Figure 2.

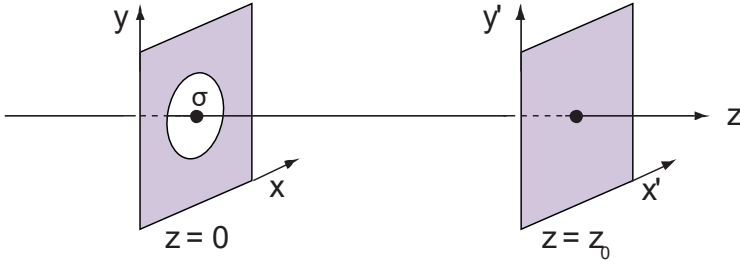

Figure 2: Lens at $z = 0$, outside of which no light can pass through the plane. Our interest is the field strength distribution in the plane $z = z_0$.

As described in section 4.1.3, the field strength distribution in the plane z_0 is:

$$E(x', y', z_0) = i \frac{e^{ikz_0}}{\lambda z_0} \iint E(x, y, 0) \cdot \exp\left(\frac{ik}{2z_0} ((x - x')^2 + (y - y')^2)\right) dx dy \quad (12)$$

But now the lens at $z = 0$ not only represents an aperture but also influences the light passing through it. This is described based on the insight from theoretical optics that a thin lens can be modelled with good approximation as a plane where a position-dependent phase shift takes place.

To derive the phase shift on a thin lens, we first envision the following: beams of light that strike the lens from the focal point are parallel behind the lens. That means a spherical wave positioned in the focal point of the lens becomes a plane wave after the lens. This consideration is sufficient to derive the phase shift.

So let us look at a spherical wave

$$E_{KW} = \frac{E_0}{|r|} \cdot e^{ik|r|} \quad (13)$$

with $|r| = \sqrt{x^2 + y^2 + z^2}$. In the following we are only looking at the phase of the spherical wave:

$$\phi_{KW} = e^{ik|r|} \quad (14)$$

For simplicity we are limiting ourselves to paths near the optical axis and establishing the propagation direction along z . These restrictions make it possible to use the approximation

$$r = \sqrt{z^2 + x^2 + y^2} \approx z \left(1 + \frac{x^2 + y^2}{2z^2}\right) \quad (15)$$

that we already used in section 4.1.3. Consequently the approximate phase of the spherical wave is

$$\phi_{KW} = e^{ikz} e^{\frac{ik}{2z}(x^2 + y^2)} \quad (16)$$

A plane wave that propagates along z is described by

$$E_{EW} = E_0 \cdot e^{ikz} \quad (17)$$

Here too we are only looking at the phase

$$\phi_{EW} = e^{ikz} \quad (18)$$

of the plane wave. As described above, the spherical wave $z = |-f|$ coming in from the front focal point is transformed into a plane wave, so that

$$e^{ikf} e^{\frac{ik}{2f}(x^2+y^2)} \cdot \tau_{Trans}(x, y) = e^{ikf} \quad (19)$$

has to apply for the phases; here we have introduced the lens transmission function $\tau_{Trans}(x, y)$ of a thin lens. This is the direct result of equation (19) with

$$\tau_{Trans}(x, y) = \exp\left(-\frac{ik}{2f}(x^2 + y^2)\right) \quad (20)$$

Now let us return to the actual problem. When we designate the field strength distribution directly before the lens in Figure 2 as $E_e(x, y)$, then the electric field when passing through the lens according to equation (20) can be written as

$$E(x, y, 0) = \tau_{Trans}(x, y) \cdot E_e(x, y, 0) \quad (21)$$

(if $\sqrt{x^2 + y^2}$ is greater than the radius of the lens, then $\tau_{Trans} = 0$).

Now we insert this expression into formula (12) and examine the field in the focal plane of the lens, in other words at $z_0 = f$:

$$\begin{aligned}
 E(x', y', f) &= i \frac{e^{ikf}}{\lambda f} \iint E_e(x, y, 0) \cdot \tau_{\text{trans}}(x, y) \\
 &\quad \cdot \exp\left(\frac{ik}{2f}((x - x')^2 + (y - y')^2)\right) dx dy \\
 &= i \frac{e^{ikf}}{\lambda f} \iint E_e(x, y, 0) \\
 &\quad \cdot \exp\left(-\frac{ik}{2f}(x^2 + y^2) + \frac{ik}{2f}((x - x')^2 + (y - y')^2)\right) dx dy \\
 &= i \frac{e^{ikf}}{\lambda f} \iint E_e(x, y, 0) \\
 &\quad \cdot \exp\left(-\frac{ik}{2f}(x^2 + y^2) + \frac{ik}{2f}(x^2 - 2xx' + x'^2 + y^2 - 2yy' + y'^2)\right) dx dy \\
 &= i \frac{e^{ikf}}{\lambda f} \iint E_e(x, y, 0) \cdot \exp\left(\frac{ik}{f}\left(-xx' + \frac{1}{2}x'^2 - yy' + \frac{1}{2}y'^2\right)\right) dx dy \\
 &= i \frac{e^{ikf}}{\lambda f} \exp\left(\frac{ik}{2f}(x'^2 + y'^2)\right) \iint E_e(x, y, 0) \cdot \exp\left(-\frac{ik}{f}(xx' + yy')\right) dx dy
 \end{aligned} \tag{22}$$

Looking at the integral term in the last expression, note that this once again is the Fourier transformation of the field distribution $E_e(x, y, 0)$. This means the Fourier transformation of the incident field distribution is found at the focal plane.

4.1.7. Optical Filtering

Optical filtering makes use of the Fourier transformation that takes place between the two focal planes of a lens as illustrated above. The spatial period of the light is divided into segments and represented as intensity peaks in the Fourier plane. Similar to the frequencies in the temporal Fourier transformation,

$$v_x = \frac{x'}{\lambda \cdot z_0} \tag{23}$$

and

$$v_y = \frac{y'}{\lambda \cdot z_0} \tag{24}$$

are defined as spatial frequencies. The spatial frequencies correspond to the transformed coordinates in position space. Spatial frequencies are not frequencies in the conventional sense. Rather they designate the number of periods per units of length. Familiar examples of spatial frequencies are the wave number $k = \frac{2\pi}{\lambda}$ of a mechanical or electromagnetic

wave and the lattice constant g of an optical lattice. When representing a structure or an image with the help of a lens, high spatial frequencies (far away from the optical axis) can be assigned to fine structures and low spatial frequencies (close to the optical axis) to coarse structures. This is easy to understand based on the resolution wedge. As shown in Figure 3, this is a bundle of lines with spaces between them that increase from left to right. In Figure 3, zones A and B have the same area, and it is immediately apparent that there are more lines in zone A than in zone B. This means the spatial frequency in zone A is higher than in zone B. Now let us consider zones A and B to be optical gratings where the lines in each zone represent the lines in the gratings. Assume the gratings are illuminated and you observe the far field diffraction pattern. Due to the high spatial frequency of the grating of zone A, the diffracted light will be further away from the central maximum than for the grating of zone B.

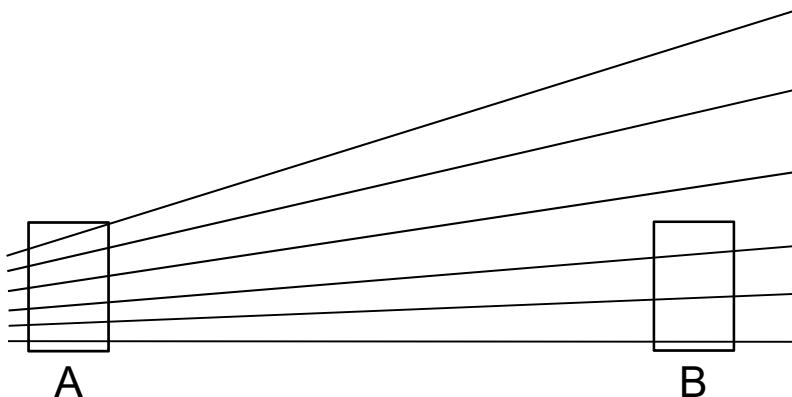

Figure 3: Resolution Wedge

Optical filtering takes advantage of the Fourier transformation that takes place in the focal plane of a lens by manipulating the Fourier transform of an image rather than the image itself. A simple lens setup demonstrates this principle. An object placed near the focal plane of a lens generates a real image on a screen, and an optical filter placed at the focal plane on the other side of the lens manipulates the Fourier transform of the image.

Optical filters are usually diaphragms intended to block specific information in the Fourier plane to generate a desired effect in the image, for example to soft-focus or sharpen an image. Information changes in the Fourier plane appear directly on the screen. Such a setup with a single lens is called a $2f$ setup and is represented schematically in Figure 4. The reverse transformation from the Fourier plane to the image in the $2f$ setup takes place through the propagation of light from the focal plane of the lens to the screen (see the diffraction formula in the Fraunhofer approximation).

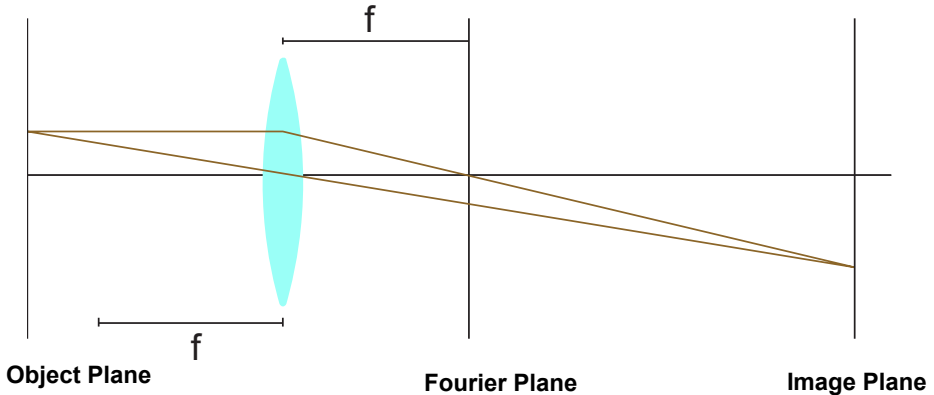

Figure 4: Schematic of the 2f Setup

To avoid large distances between the object plane and image plane, we can expand the 2f setup into a 4f setup which results in a shorter optical path. As shown in Figure 5, the object plane in the 4f setup is equivalent to the front focal plane of the first lens. The rear focal plane of the first lens and the front focal plane of the second lens form the Fourier plane. The image plane is in the rear focal plane of the second lens. The reverse transformation from the Fourier plane is carried out by the second lens.

This test kit is essentially a 4f setup with additional optical elements for illumination. The first lens is the objective lens, and the second is the tube lens.

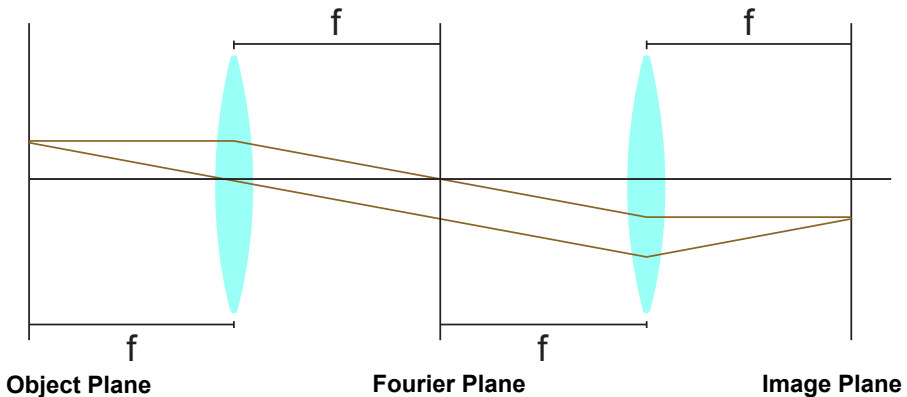

Figure 5: Schematic of the 4f Setup

Optical filtering of the image transformation in the Fourier plane can achieve various effects. For example, an image of a line lattice can be produced by imaging a cross lattice and filtering intensity peaks through an aperture slot in the Fourier plane. Image simulations are a vivid means to understand the effects of using masks in the Fourier plane. Readily available software allows us to simulate the effects of various masks.

Gwyddion freeware is a useful tool for simulating Fourier optics³. While the software can be used for complex image editing, it can also be used to simulate many of the basics of Fourier optics. One can load an image (File → Open) and then use “Edit Data” → “Correct Data” → “2D FFT Filtering” to view and even trim the Fourier image.

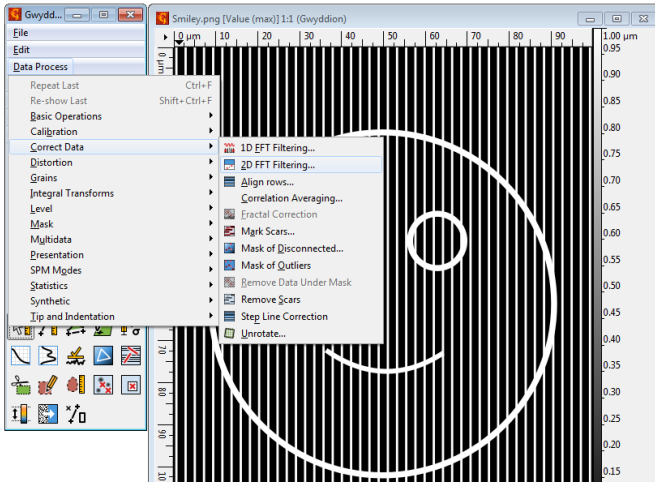

Figure 6: Interface of the Gwyddion Program

Select the area of interest in the mask editor (on the left of Figure 7). In case of the smiley face, we select “Fill” and then remove the first peaks of the lattice (points on the horizontal axis). Then the result is displayed with “Filtered Image” (see Figure 7, right).

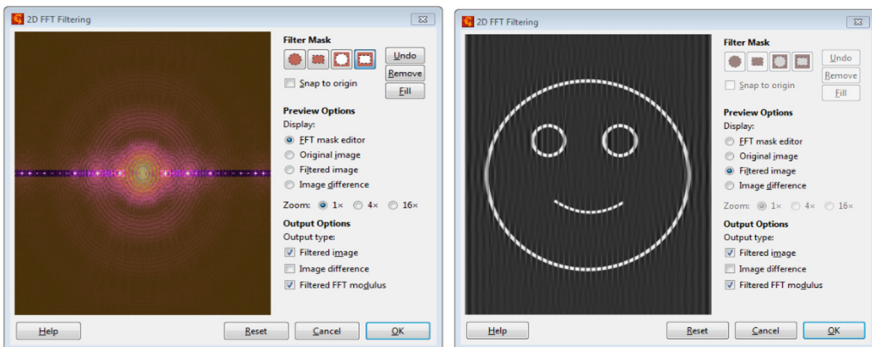

Figure 7: 2D-FFT Dialogue Window in Gwyddion

³ Download under <http://gwyddion.net/>

In Figure 8, all information indicating vertical lines in the lattice was blocked with a simulated aperture slot using Gwyddion⁴. The information for horizontal lattice lines remains.

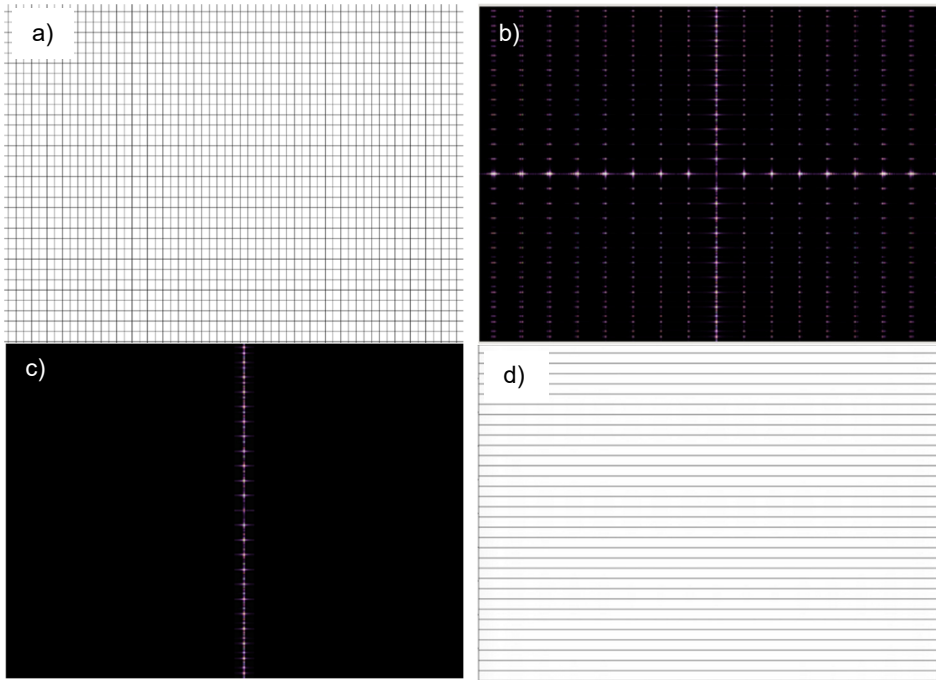

Figure 8: Simulated Fourier Filtering with the 2D-FFT Function in Gwyddion: a) Original Image, (b) Fourier Transform of the Image, (c) Fourier Transform Passing Through Vertical Slit Mask, and (d) Final Image

⁴ Download under <http://gwyddion.net/>

Blocking high spatial frequencies (intensity peaks at a large distance from the optical axis) creates a soft-focus for images. This optical image editing process is called optical low pass filtering; only information about coarse structures is passed. Figure 9 shows the soft-focus effect through an aperture plate simulated with Gwyddion.

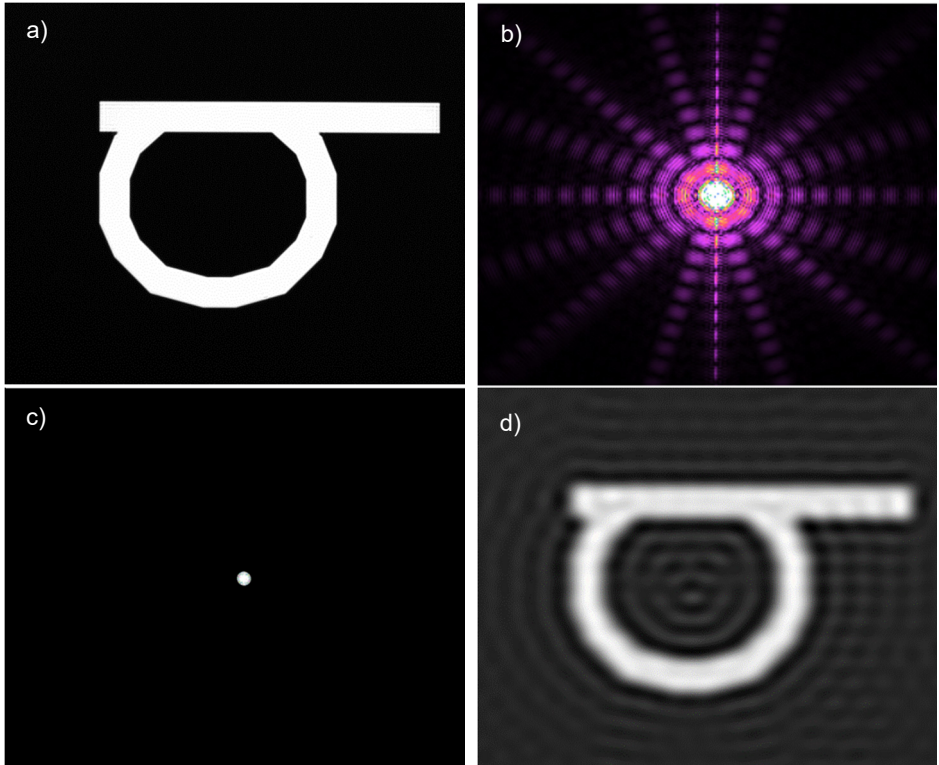

Figure 9: Simulated Soft-Focus Effect Using the 2D-FFT Function in Gwyddion: a) Original Image, (b) Fourier Transform of the Image, (c) Fourier Transform Passing Through Circular Aperture, and (d) Final Image

Alternatively, blocking lower spatial frequencies (intensity peaks close to the optical axis) can bring out the edges of an image and increase contrast. This optical image editing process is called optical high pass filtering; only information about fine structures is passed.

Figure 10 illustrates bringing out the edges in an image using a circular aperture simulated with Gwyddion. Bringing out the edges makes the images appear sharper; however, optical high pass filtering does not actually improve the focus of the image.

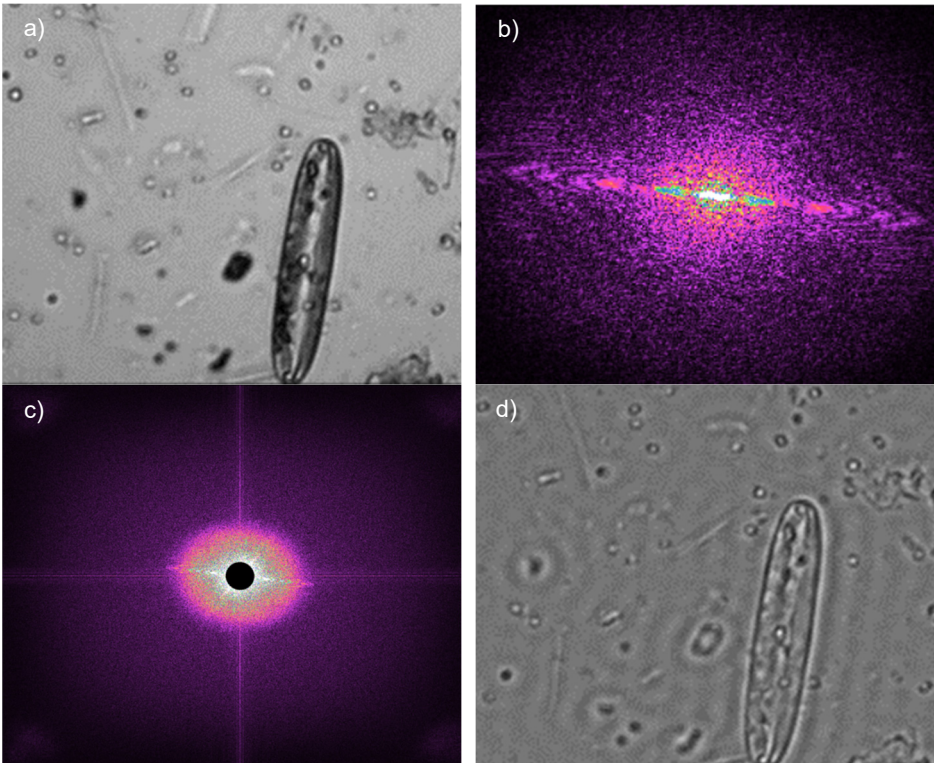

Figure 10: Simulation of Bringing out Edges and Improving the Contrast with the 2D-FFT Function in Gwyddion: a) Original Image, (b) Fourier Transform of the Image, (c) Fourier Transform with Circular Mask Blocking Center, and (d) Final Image

4.1.8. Misconceptions

As previously discussed in section 4.1.1, the Fourier transformation has the following form

$$F(u, v) = \int_{-\infty}^{\infty} \int_{-\infty}^{\infty} f(x, y) \cdot e^{-i2\pi(ux+vy)} dx dy \quad (25)$$

$$f(x, y) = \int_{-\infty}^{\infty} \int_{-\infty}^{\infty} F(u, v) \cdot e^{i2\pi(ux+vy)} du dv \quad (26)$$

Here one should keep in mind that the coefficients in $F(u, v)$ are generally complex numbers. Accordingly, they contain a real and an imaginary component, or amplitude and phase information, that is

$$F(u, v) = F_r(u, v) + i \cdot F_i(u, v) = |F(u, v)| \cdot e^{i\varphi(u, v)} \quad (27)$$

with the amplitude $|F(u, v)|$ and the phase $\varphi(u, v) = \tan^{-1}(F_i(u, v)/F_r(u, v))$.

When we examine the Fourier plane behind the objective lens, the human eye perceives the *amplitude* but not the phase. This means that the brightness distribution alone does not contain the complete information of the diffracting structure. As we have established, applying the Fourier transformation twice results in the original image. This often leads to the misconception that a mask in the shape of the brightness distribution could be used as an object which would then project an image of the original object into the Fourier plane.

This assumption, however, is incorrect because the brightness distribution does not contain the necessary phase information. When an image of the diffraction pattern of a single slit is placed in the object plane, it does not produce an image of a slit in the Fourier plane.

This is illustrated in Figure 11. The Matlab code used to generate the images can be found in Chapter 10. We use an image of a tiger as our sample image⁵ in Figure 11a. First, a Fourier transformation is applied to the original image. Amplitude and phase, according to equation (27), are plotted in Figure 11b and Figure 11c, respectively.

In Figure 11d, we performed a second Fourier transformation using only the amplitude distribution. The resulting image has no discernible structure. Next, an image consisting only of noise, cf. Figure 11e was used as amplitude and transformed together with the phase information of the original image. The original image is clearly discernible in the resulting Figure 11f. The conclusion is that the phase distribution is an essential part of the information. Even using random amplitude information, the Fourier Transform of the phase was able to reproduce a recognizable image. Therefore, the Fourier transformation should not be reduced to just the (visible) amplitude⁶.

⁵ The image is taken from pixabay.de under Creative Commons CC0.

⁶ In practice, this effect works best with images with high contrast and low resolution.

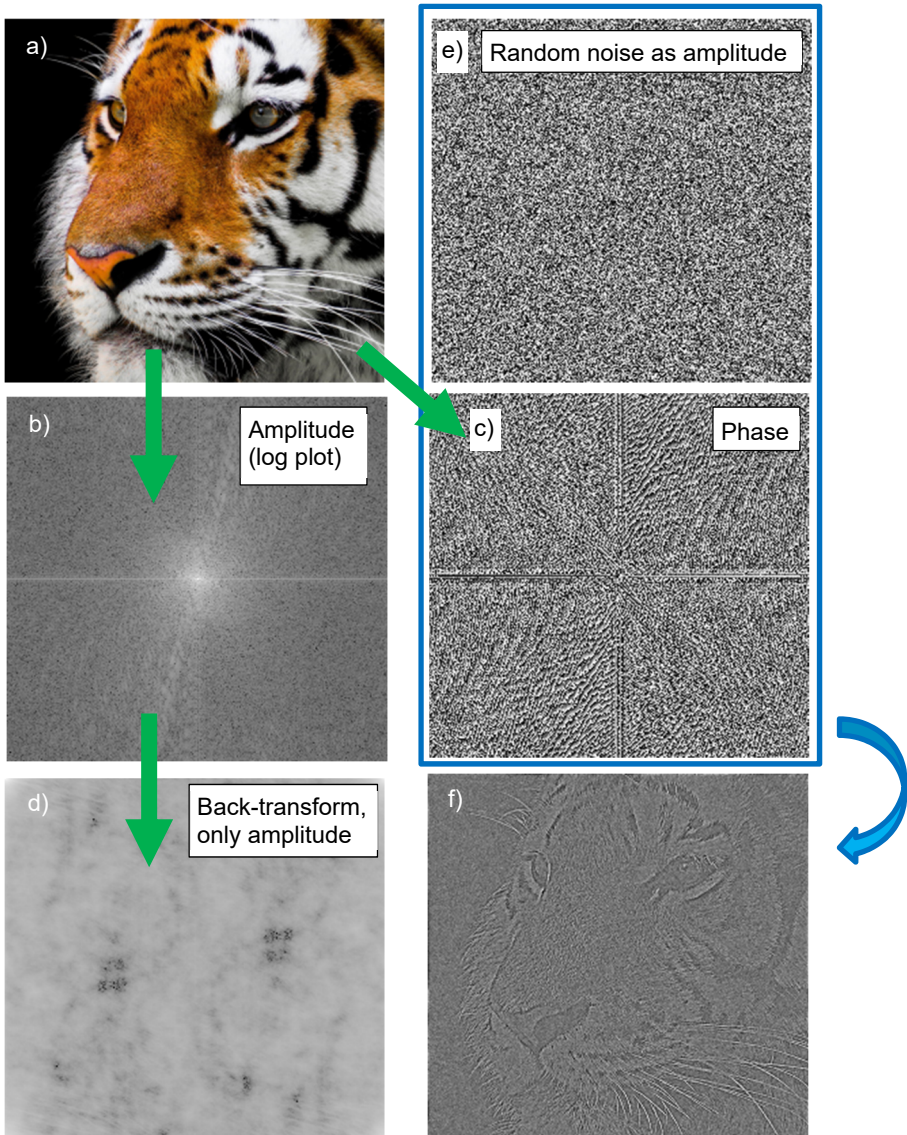

Figure 11: We examine the Fourier transform of the image of a tiger. When random noise (e) is transformed back together with the actual phase information (c) of the original image (a), then the original image is discernable, see (f). This is in contrast to the back-transform of only the amplitude (b) in image (d). The conclusion is that the phase information plays a crucial role in Fourier transform and Fourier optics.

When the phase of light is also taken into account, one can design the object plane so that any image can be in the Fourier plane. Devices that make this possible are called spatial light modulators. Thorlabs offers such devices under the product name *Exulus*.⁷ Also, the effect can be achieved with a suitably microstructured sample that diffracts light in the desired way. An example is part of this kit.

4.2. Microscope Fundamentals

A microscope is a device used to magnify the image of objects that are too small for the human eye to perceive. In its most basic form, a microscope consists of two lenses or lens systems: the objective lens and the eyepiece lens. The distance between these two lenses is significantly larger than the sum of their focal lengths, f_{Obj} and f_{EP} ; the distance t between the focal planes is called the tube length, t . Figure 12 shows the beam path in a simple microscope that one looks through with the eye.

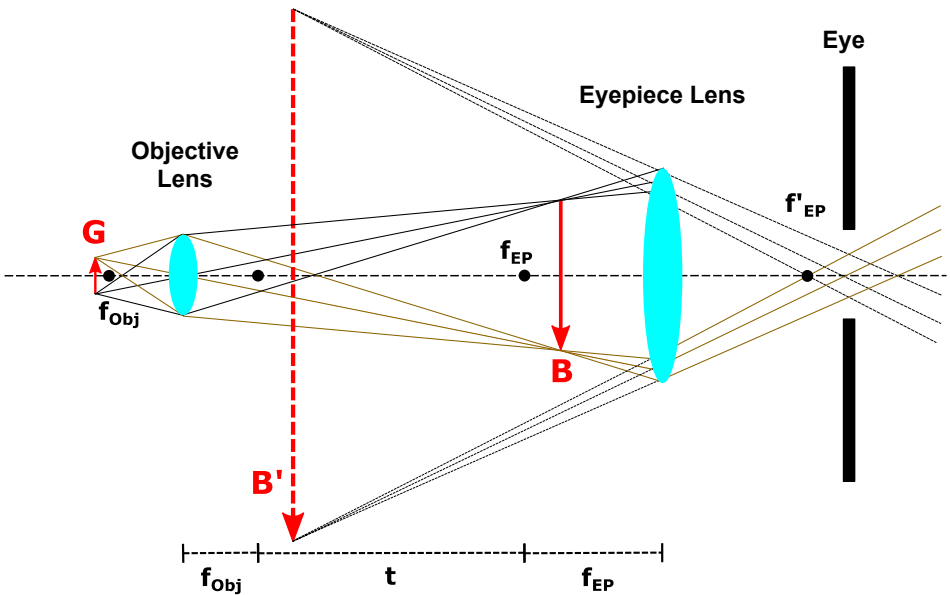

Figure 12: Beam Path in a Simple Microscope

The object G is immediately before the front focal plane of the objective lens, f_{Obj} . The objective lens creates a real image B that is inverted and enlarged and lies behind the front focal plane of the eyepiece, f_{EP} . The image B serves as the object for the eyepiece. Because B lies inside the focal length of the eyepiece, the eyepiece creates a magnified virtual image B' , which appears in the space between the two lenses. The lens in the

⁷ https://www.thorlabs.com/newgrouppage9.cfm?objectgroup_id=10378

observer's eye adjusts to use B' as its object to create a sharp real image on the photoreceptors of the retina.

When a camera rather than the eye is used for viewing, the eyepiece lens is removed, and the intermediate image projects directly onto the chip. Alternatively, a microscope with an infinity-corrected beam path is commonly used when imaging with a camera as shown in Figure 13.

In this microscope, the object **G** is at the focal point of the objective lens. This results in a collimated beam behind the objective lens. A tube lens with the focal length f_{Tu} projects the image **B** directly onto the camera chip. No further magnification as when viewing with the eye is needed here.

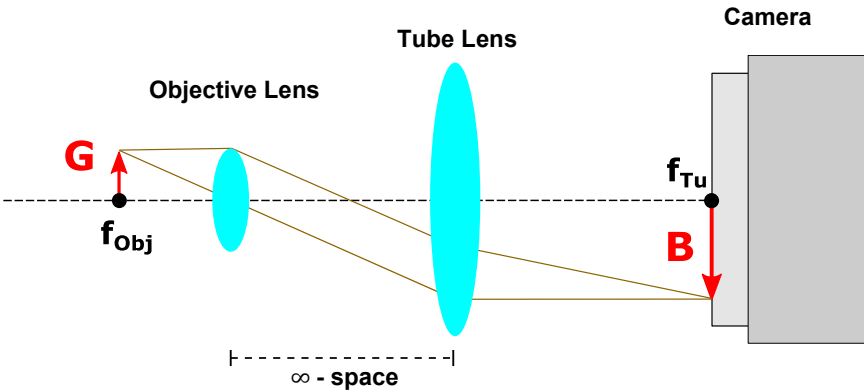

Figure 13: Beam Path in an Infinity-Corrected Microscope

A benefit immediately apparent from Figure 13 is that the tube lens can be placed at almost any distance from the objective lens since the beam path behind the objective lens is collimated. Thus, the size of the setup is flexible. It is also possible to install plane-parallel components (filters, beam splitters, etc.) without changing the image size or position.

Magnification and Reproduction Scale of the Microscope:

The magnification of the simple microscope, as shown in Figure 12, is the product of the magnification of the objective lens $V_{Obj} = B/G = t/f_{Obj}$ and the magnification of the eyepiece lens $V_{EP} = s_0/f_{EP}$:

$$V_{Microscope} = \frac{t \cdot s_0}{f_{Obj} \cdot f_{EP}} \tag{28}$$

Here t is the tube length of the microscope derived from the distance between the rear focal plane of the objective lens and the front focal plane of the eyepiece lens. s_0 designates the least distance of distinct vision for the human eye, which is 25 cm by definition.

Since this concept of magnification accounts for the optics of the eye, we must instead specify the measurable reproduction scale for our camera-based, infinity-corrected

microscope in Figure 13. It is derived simply from the focal lengths of the objective lens and tube lens:

$$V = \frac{B}{G} = \frac{f_{Tu}}{f_{Obj}} \quad (29)$$

4.3. Köhler Illumination

If one wants to examine an object with a microscope, one generally has the problem that the illuminating light source itself has a certain extent and structure (e.g. coiled filament, LED chip), which leads to uneven illumination of the object, may expose the object to heat, and produces scattered light. Köhler illumination, named after its developer August Köhler⁸, allows one to avoid these issues and is common practice in microscopy today. The lighting system essentially consists of a collector lens for the light source, a condenser lens, and two diaphragms, the aperture diaphragm and the field diaphragm.

⁸ A. Köhler: "Ein neues Beleuchtungsverfahren für mikrographische Zwecke", Zeitschrift für wissenschaftliche Mikroskopie und mikroskopische Technik, Band X, Heft 4, page 433 – 440 (1893)

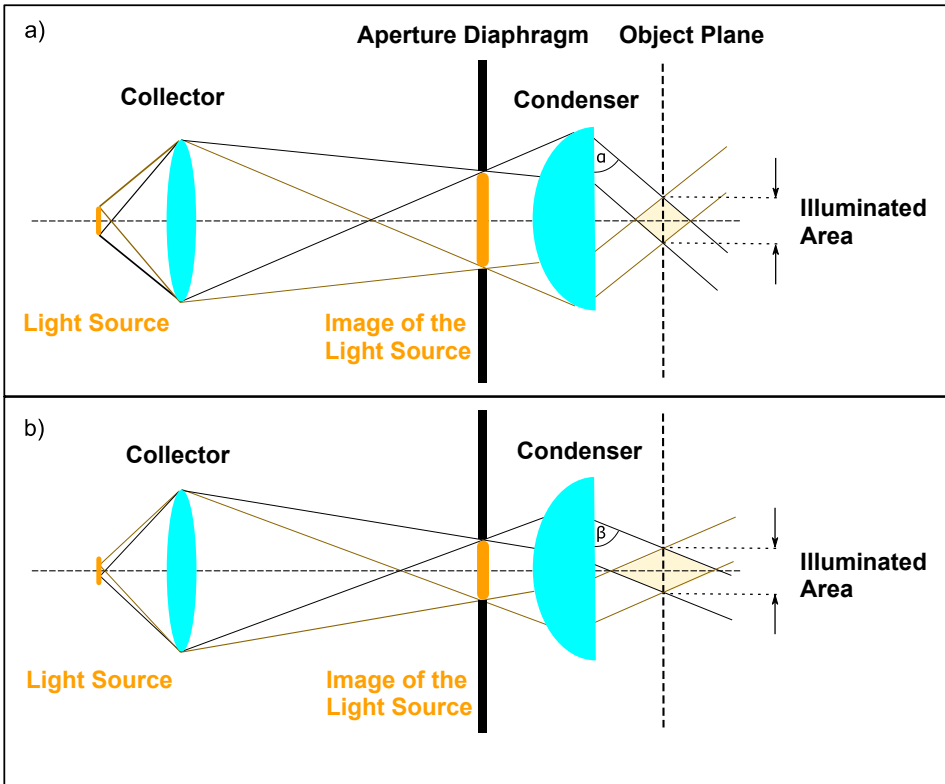

Figure 14: Image of the light source on the aperture diaphragm. Changing the aperture size alters the incidence angle of the marginal rays in the object plane, but does not alter the illuminated area. a) and b) show examples of different aperture diaphragm opening widths.

Aperture Diaphragm

First, the collector lens images the light source onto the plane of the aperture diaphragm that is in the focal plane of the condenser lens (see Figure 14). Thanks to this trick of using the *image* of the light source to illuminate the object, the light source itself does not have to be placed into the focal plane of the condenser, so there is no risk of overheating the object. Now varying the diameter of the aperture diaphragm can adjust the angle of the marginal rays from the light source to match the aperture of the objective lens. The illuminated area on the object remains unchanged in this process. Another benefit of using the image of the light source for illumination is that inhomogeneities are minimised.⁹ Figure 14 shows how sample illumination is affected by a) a larger opening in the aperture diaphragm and b) a smaller opening. A larger (a) or smaller (b) proportion of the light

⁹ F. K. Möllring: "Mikroskopbeleuchtung nach Köhler", Mikrokosmos 83, page 109–115 (1994)

source is displayed as a result, and the angle of the marginal rays behind the condenser consequently gets smaller/steeper (α) or larger/flatter (β). The illuminated area in the object plane always stays the same size regardless of the aperture diaphragm opening.

Field Diaphragm

The field diaphragm is installed between the collector and the aperture diaphragm so that the condenser lens projects the diaphragm's image in the plane of the object being examined (see Figure 15; the aperture diaphragm was omitted in this illustration for clarity). The illuminated area on the object can be adjusted by varying the diameter of the field diaphragm; the angles of the marginal rays stay the same. Thus, interfering scattered light can be eliminated. Fundamentally, one could place a diaphragm directly in the object plane for this purpose, but since this is not very practical, one uses the trick of positioning the field diaphragm outside the object plane and projecting it there.

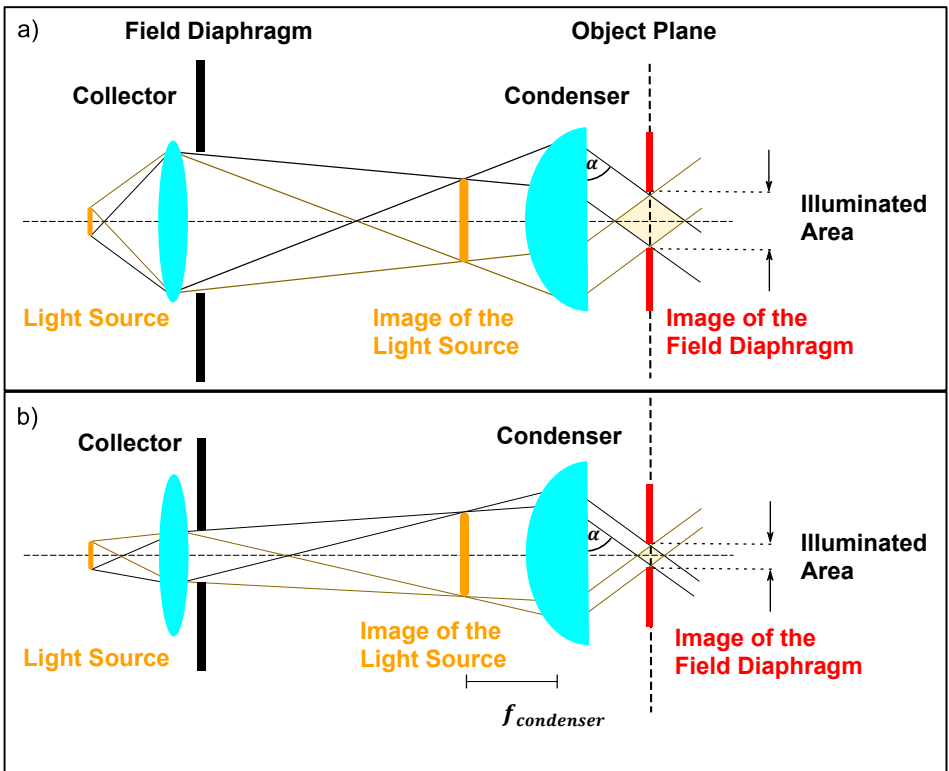

Figure 15: Display of the field diaphragm in the object plane with the help of the condenser. Changing the aperture size alters the illuminated area in the object plane, but not the aperture (angle of the marginal rays) of the illumination (aperture diaphragm not shown here). a) and b) show examples with different field diaphragm opening widths.

Since the field diaphragm is displayed in the object plane, an image of the field diaphragm proportional to the diaphragm opening appears in the sample plane, which means the size of the illuminated area changes as well. The angle (α) of the marginal rays after the condenser is independent of the diaphragm opening.

A major advantage of this method is that the illumination aperture and the illuminated area can be adjusted independently of each other.

An additional lens called the field lens can be added for classic Köhler illumination, as in our setup. The extra lens is positioned between the field diaphragm and aperture diaphragm. This makes additional focusing possible and helps increase the intensity per unit area in the object plane.

4.4. Optical Path of the Microscope

This is a sketch of the optical path in our setup.

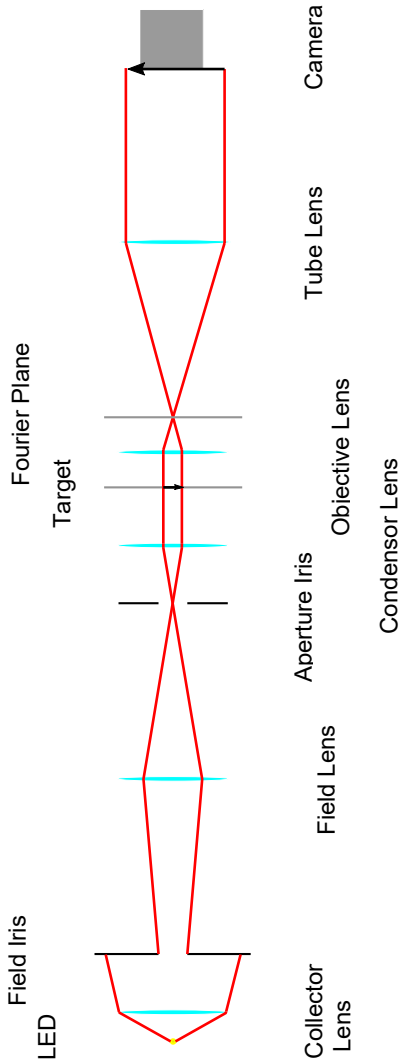

Figure 16: Optical Path of the Microscope

4.5. Diffraction and Angular Resolution of the Microscope

This subsection shows that diffraction is the essential factor that limits classic optical microscopy¹⁰. Let us imagine a lens that is illuminated with parallel light (for example by a distant source).¹¹ The lens naturally limits the light field since it has a finite diameter D . This inevitably produces a diffraction pattern at the focal point, where the diameter of the central diffraction maximum is given by

$$d_{diff} = 2.44 \cdot \frac{f_1 \cdot \lambda}{D} \quad (30)$$

(see Figure 17), where f_1 designates the focal length of the lens and λ the wavelength of the light being used.

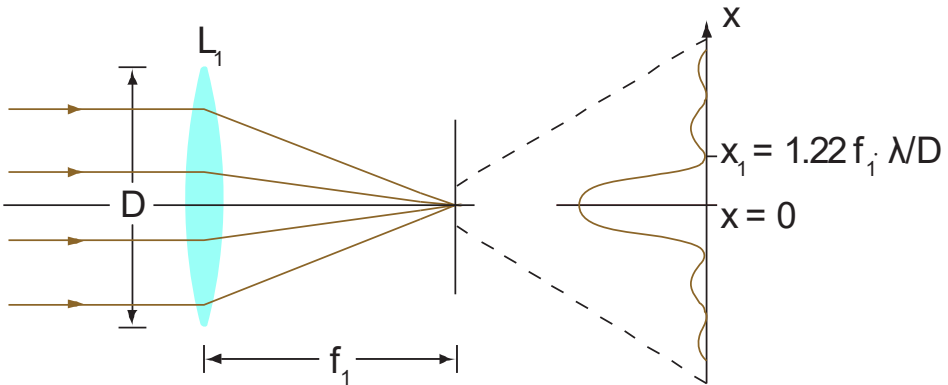

Figure 17: Diffraction Pattern Through a Lens

Consequently the diffraction patterns of two different sources would overlap. Accordingly, the question arises: what is the minimum separation for two point sources to be perceived separately (see Figure 18)?

¹⁰ Note that various methods to overcome the diffraction limit are known, such as STED microscopy. In 2014 Stefan Hell, Eric Betzig and William E. Moerner received the Nobel Prize in Chemistry for the development of super-resolution fluorescence microscopy methods.

¹¹ The line of thought described here is based on Demtröder II.

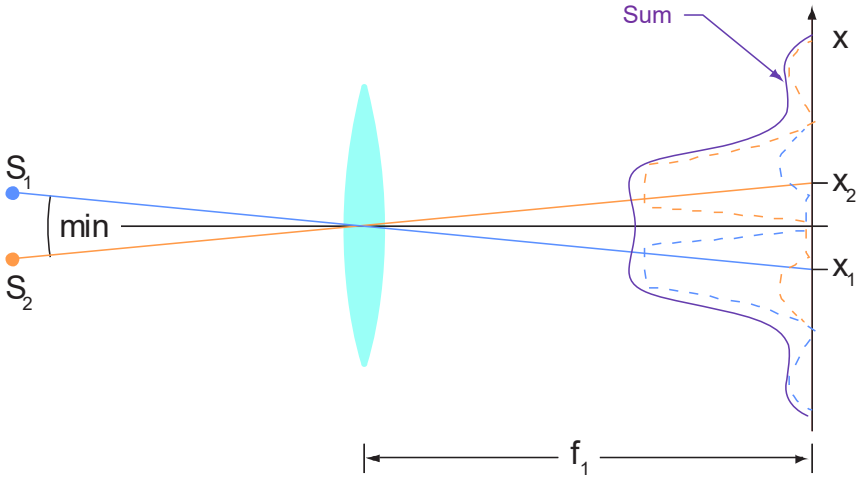

Figure 18: Two points can be differentiated in an image when they meet the Rayleigh criterion.

The Rayleigh criterion is applied here: two point sources can still be perceived as separate when the main maximum of the diffraction pattern of source S_1 coincides with the first minimum of the diffraction pattern of S_2 .

As discussed in the preceding subsection, the objective lens in a classic microscope creates a real image of the object. If one wants to perceive two points on the object separately in the image (and therefore in the eye/on the camera), then the distance between the two points Δx must be large enough so the diffraction patterns of both points meet the Rayleigh criterion – see Figure 19.

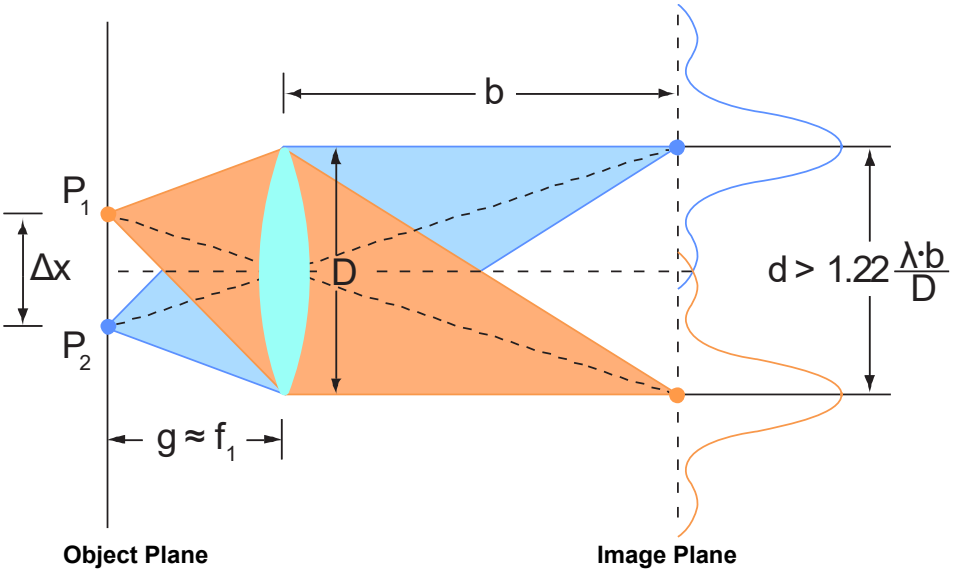

Figure 19: Illustration of Two Points at Distance Δx with a Lens

This means that the distance between the main maxima in the diffraction pattern must be greater than

$$d_{min} = 1.22 \cdot \frac{b \cdot \lambda}{D} \tag{31}$$

with b representing the image distance. According to the lens image equation, the ratio of the image distance and object distance is equal to the ratio of the image size and object size. Thus

$$\frac{b}{g} = \frac{1.22 \cdot \frac{b \cdot \lambda}{D}}{\Delta x} \Rightarrow \Delta x = 1.22 \cdot \lambda \cdot \frac{g}{D} \tag{32}$$

Since the object distance essentially corresponds to the focal length, $g \approx f$, the resulting smallest distance that can still be resolved is

$$\Delta x = 1.22 \cdot \lambda \cdot \frac{f}{D} \tag{33}$$

One should also consider the refractive index n between the object and objective lens together with one-half of the maximum collection angle α , for which

$$2 \cdot \sin \alpha = \frac{D}{f} \quad (34)$$

applies. The numerical aperture, given by

$$NA = n \cdot \sin \alpha \quad (35)$$

accounts for both of these variables.

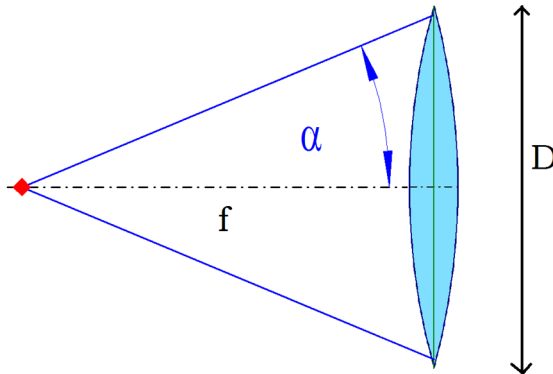

Figure 20: Sketch of the Numerical Aperture

By plugging equations (34) and (35) into (33) we find that the resolving power is

$$\Delta x_{min} = 0.61 \cdot \frac{\lambda}{NA} \quad (36)$$

Ernst Abbe first published this limitation of resolution due to diffraction at the end of the 19th century. The limitation is derived on the basis that at least the first diffraction order is needed to form an image. This can be readily understood using a lattice: the distance between the central maximum and first order diffraction directly translates to the lattice constant of the lattice. A diffraction pattern where the first order diffraction maxima are farther apart corresponds to a lattice with a smaller lattice constant. If all diffraction orders including the first are masked, this corresponds to a lattice with an arbitrarily small lattice constant. Thus, an image of the lattice cannot be generated without the first order diffraction. The central maximum in a diffraction pattern alone does not carry any information. Display is only possible with the diffraction orders.

If the structures are too small, then the collection angle required for the first order diffraction is *greater* than the numerical aperture of the lens. This means that the first diffraction order passes by the lens and (like all higher orders) cannot contribute to imaging. Only the central maximum passes through the lens. With this information, Abbe was able to approximately determine the resolution limit of classic microscopy.

Chapter 5 Setup and Adjustment

This section describes assembling the individual components and positioning them in the setup. Then we discuss the functions of the individual elements and the diffraction elements included in the kit.

5.1. Assembly of the Components

Distribute the eight RDF1 rubber feet symmetrically around the bottom of the breadboard and screw them in place using the 1/4"-20 x 1/2" (M6 x 12 mm) screws.

Screw the BE1(/M) pedestal base adapters under all PH2 (PH50/M) post holders. Please distinguish carefully between the PH2E (PH50E/M) pedestal post holder and the PH2 (PH50/M)+BE1(/M) combination. They are chosen to provide the optimal amount of height adjustment.

LED



Components:
Cold White LED
SM1RC(/M) Slip Ring
SM1V10 Adjustable Lens Tube
SM1RRC Thick Retaining Ring
ACL2520U-A Condenser Lens
TR2 (TR50/M) Post

Camera



Components:
CS165CU(/M) CMOS Camera
SM1L30 Lens Tube
TR2 (TR50/M) Post

LED: First insert the LED into the SM1RC(/M) slip ring. You may have to loosen the 9/64" (3 mm) hex locking screw on the slip ring to do so. Then secure the LED in the holder by tightening the screw. Next unscrew the retaining ring from the SM1V10 tube. Insert the ACL2520U-A condenser lens with the flat side first (the flat side faces the LED).¹² Now screw in the SM1RRC extra-wide retaining ring instead of the narrow retaining ring you just removed. This prevents the SPW606 spanner wrench from damaging the lens when screwing in the retaining ring. Finally, screw the SM1V10 tube into the thread on the LED. Use the PH2 (PH50/M) + BE1(/M) combination for mounting.

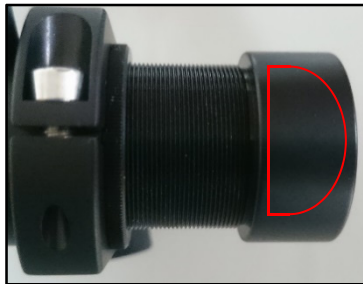

Connect the LED to the LEDD1B driver with the cable. Note that the LED is designed for a current up to **1300 mA**. Set the current limit to 1200 mA on the LED driver by turning the arrow on the current limit adjuster with a narrow screwdriver (see the photo on the right).

The mode switch on top of the controller should be set to CW.

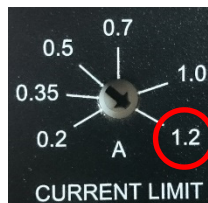

Camera: Attach the SM1L30 lens tube to the camera. Remove the retaining ring from the lens tube and set it aside for the assembly of the objective lens component. Cover the end of the lens tube with the SM1EC2B snap-on dust cap to protect the camera sensor. Screw the 1/4"-20 x 1/2" (M6 x 12 mm) setscrew into the bottom of the camera and attach it to the bottom of a TR2 (TR50/M) post. Make sure that the "Zelux" label is facing upward to ensure the correct orientation of the camera chip. Feed a hex key through the side hole of the post for extra leverage during tightening. Remove the setscrew that comes with the TR2 (TR50/M) from the top of the post. Use the PH2 (PH50/M) + BE1(/M) combination to hold the post.

Beamsplitter: The BS028 beamsplitter has to be installed in the CCM1-4ER(/M) cube. To do so, remove the small black 1.5 mm hex screws on the sides of the cube and pull off the top. Now unscrew the silver 1.5 mm hex screws at the corners of the triangle-shaped top. Take the beamsplitter out of its packaging and set it into the housing upside down so that the engraved arrows are at the bottom. Note the orientation shown in Figure 21. Replace the triangle top and tighten the silver screws to secure the cube. Now place the top of the housing in the orientation shown in Figure 21 and secure it with the black screws. Finally, screw a TR2 (TR50/M) post to the bottom of the CCM1-4ER(/M). Use the PH2 (PH50/M) + BE1(/M) combination for mounting. You can add the label to the CCM1-4ER(/M) cube if desired.

¹² We recommend wearing gloves when handling optics. Also, lens cleaning tissues are recommended for cleaning the lenses, available from Thorlabs under part number MC-5.

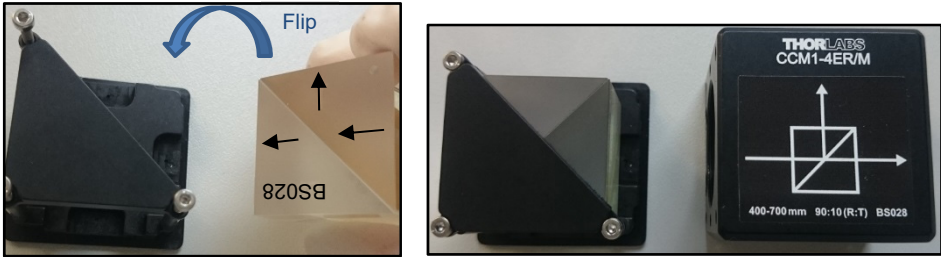

Figure 21: The arrows in the left image indicate the orientation of the engraving on the beamsplitter cube. The supplied label can be added to the beamsplitter housing as shown in the right image.

Iris Diaphragms: Each iris diaphragm is supplied with a TR3 (TR75/M) post.

- Keep the TR3 (TR75/M) post attached to the two ID12(/M) irises. Use a PH2E (PH50E/M) pedestal post holder with each of them.
- Remove the TR3 (TR75/M) post from the ID25(/M). Remove the setscrew from the TR2 (TR50/M) and screw the post to the ID25(/M). Screw the setscrew from the TR2 (TR50/M) post into the TR3 (TR75/M) post; this will be used to mount the green filter. Use the PH2 (PH50/M) + BE1(/M) combination for mounting the iris.

Green Filter



Components:
TRF90(M) Flip Mount
FB550-40 Green Filter
TR3 (TR75/M) Post

Field and Tube Lenses



Components:
LMR1(/M) Lens Holder
AC254-150-A Lens
TR2 (TR50/M) Post
(Note: Components are identical for the field and tube lens.)

Condenser Lens



Components:
LMR1(/M) Lens Holder
SM1L05 Tube
AC254-050-A Lens
TR2 (TR50/M) Post

Projection Lens



Components:
LMR1(/M) Lens Holder
LB1901 Lens
TR2 (TR50/M) Post

Green Filter: Remove the retaining ring from the TRF90(/M) flip holder, insert the FB550-40 filter, and tightly screw on the retaining ring again. Please note the direction of the filter (see the photo below). Use a TR3 (TR75/M) post (the one you set aside during the ID25(/M) iris assembly) and a PH2E (PH50E/M) holder for mounting.



Figure 22: Assembly of the green filter: note the orientation indicated by the white arrow on the filter's mount.

Field and Tube Lenses: Unscrew the retaining ring from the LMR1(/M) lens holder. Then insert the AC254-150-A lens and secure it with the retaining ring. Use a TR2 (TR50/M) and the PH2 (PH50/M) + BE1(/M) combination for mounting. Repeat these steps to build a second lens. As with all lenses, you may stick the included labels, "Field Lens" and "Tube Lens," on top of the mounts for easier recognition.

Condenser Lens: Remove the retaining ring from the SM1L05 tube. Insert the AC254-050-A lens with the flat side first and firmly screw on the retaining ring again. Unscrew the retaining ring from the LMR1(/M) lens holder and screw the SM1L05 tube into the lens holder. Use a TR2 (TR50/M) and the PH2 (PH50/M) + BE1(/M) combination for mounting.

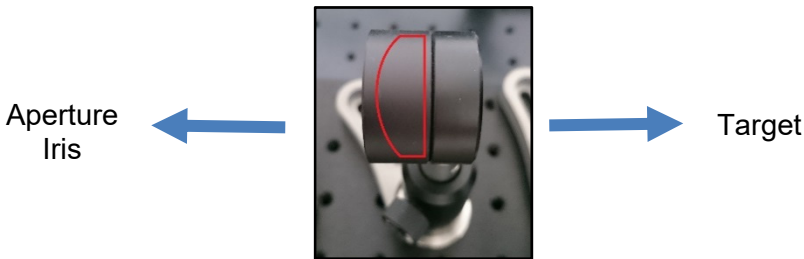

Figure 23: Condenser Lens Orientation

Projection Lens: Unscrew the retaining ring from the LMR1(/M) lens holder. Then insert the LB1901 lens and secure it with the retaining ring. Use a TR2 (TR50/M) post and the PH2 (PH50/M) + BE1(/M) combination for mounting.

Viewing Screen



Components:
 EDU-VS1(/M) Viewing Screen
 BA2(/M) Base
 PH1.5 (PH30/M) Post Holder
 TR1.5 (TR30/M) Post

Objective Lens



Components:
 KCP05(/M) Adapter
 SMR1(/M) Lens Holder
 SM1ZM Zoom Housing
 AC254-030-A Lens
 TR2 (TR50/M) Post

Slide Holder



Components:
 FP01 Plate Holder
 TR2 (TR50/M) Post

Viewing Screen: Use the 1/4"-20 x 3/8" (M6 x 10 mm) cap screw to attach the BA2(/M) base to the PH1.5 (PH30/M) post holder. Then screw the TR1.5 (TR30/M) to the EDU-VS1(/M) screen and insert it into the post holder.

Objective Lens: Use the 8-32 x 1/4" (M4 x 6 mm) cap screw to attach the SMR1(/M) lens holder to the unthreaded hole in the KCP05(/M) adapter. Screw the TR2 (TR50/M) post into the threaded hole. Next, remove the retaining ring from the SM1ZM zoom housing. Insert the AC254-030-A lens into the lens tube with the flat side first and secure it with a retaining ring. Engage the locking screw at the side of the SM1ZM with a 0.035" (0.9 mm) hex key. Make sure to screw the SM1ZM tightly into the SMR1(/M) lens holder. Insert the retaining ring you set aside during the assembly of the camera component into the open side of the SMR1(/M) and secure it tightly to further lock the SM1ZM in place. Mount the assembly in a PH2E (PH50E/M) pedestal post holder.

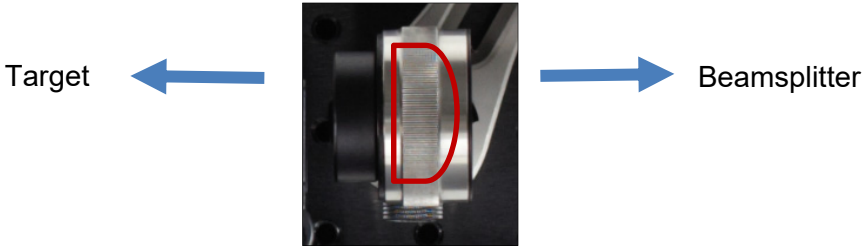

Figure 24: Objective Lens Orientation

Slide Holder/Diatoms Slide: Screw a TR2 (TR50/M) post onto the FP01 plate holder with an 8-32 x 1/4" (M4 x 6 mm) cap screw and set the diatoms slide into the holder. Use the PH2 (PH50/M) + BE1(/M) combination for mounting.

Inverse Fourier Target/Diffractive Optical Element (DOE): The target comes in an adhesive wrapping. Cut off the packaging's edge and detach it from the target.



ATTENTION



IMPORTANT: Wearing gloves for the installation of the chrome-on-glass target is highly recommended in order to avoid contamination.

XY Holder for Target Slides: The XYF1(/M) is an XY holder for slides that can be screwed to a post in various orientations. Screw the holder to a TR2 (TR50/M) post in the orientation shown in Figure 25. Feed a hex key through the post's side-located $\text{\O}1/8"$ ($\text{\O}3.2$ mm) hole for extra leverage when tightening the mount to the post.

- **Target:**

- Remove the two sliders at the top of the mount using a 5/64" (2 mm) hex key.
- Switch the positions of the two sliders so the 4 lateral retaining screws are on the same side as the mount's labels; see Figure 25 (left).
- Mount the EDU-TGB1 chrome-on-glass target in the XY holder by loosening the four small 5/64" (2 mm) hex lateral retaining screws slightly. Then loosen the locking screw on the top of each slider. Slide the holder fully open and insert the target. First secure the large screw on each slider followed by the 4 small retaining screws. To verify the correct orientation, check that the lattice designations can be read from the front (the side with the scales on the holder), as shown in Figure 25.

When installing the target, you want it to land on the ledge (highlighted blue in the illustration). Do not let the target fall into the adjustment channel. That would cause the target to break when tightening the setscrews.

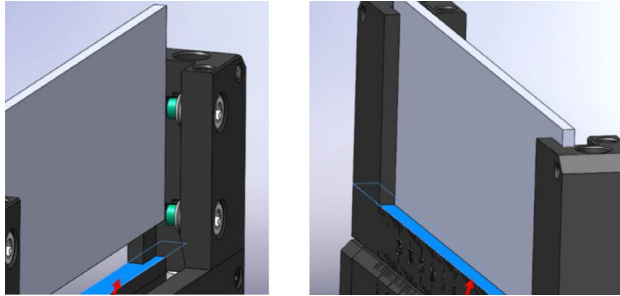

- Use the PH2 (PH50/M) + BE1(/M) combination for mounting.
- **Mask:**
 - Loosen the 5/64" (2 mm) hex screw on the head of the upper slider.
 - Insert the EDU-TGC1 mask. Move the upper slider down and tighten the four 5/64" (2 mm) hex retaining screws to secure the mask in the mount. Verify that the slider's position matches the photo on the right in Figure 25. Please note the orientation of the target.

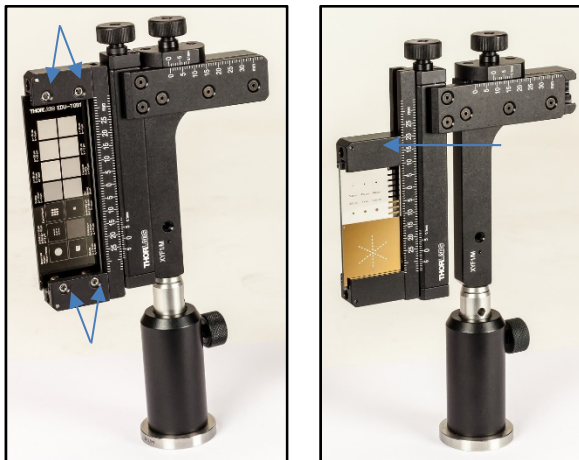

Figure 25: Target (Left) and Mask (Right) Mounting in the XYF1(/M) Mounts: The blue arrows indicate the orientation of the sliders.

Rotatable Slit:**ATTENTION**

IMPORTANT: Before screwing the VA100(/M) variable slit to the SM05T2 thread adapter, make sure that the SM05T2 only has a few millimeters of free thread. Otherwise, you risk pressing the threaded part of SM05T2 against the blades of the VA100(/M).

Remove the retaining ring from the RSP1D(/M) rotation mount. Screw the SM1A6 SM1-to-SM05 threaded adapter all the way into the rotation mount and screw the retaining ring in after the adapter to secure it. Screw the SM05T2 adapter into the SM1A6 from the back of RSP1D(/M). Now screw the VA100(/M) variable slit onto the SM05T2 adapter. Finally, adjust the scale of the rotation mount. Slightly loosen the two 5/64" (2 mm) hex screws on the front of the RSP1D(/M) and turn the scale until the 0° mark is parallel to the slit. Then tighten the small screws again. Use the PH2 (PH50/M) + BE1(/M) combination for mounting.



Components:
 RSP1D(/M) Rotational Mount
 VA100(/M) Variable Slit
 SM1A6 Threaded Adapter
 SM05T2 Threaded Adapter
 TR2 (TR50/M) Post

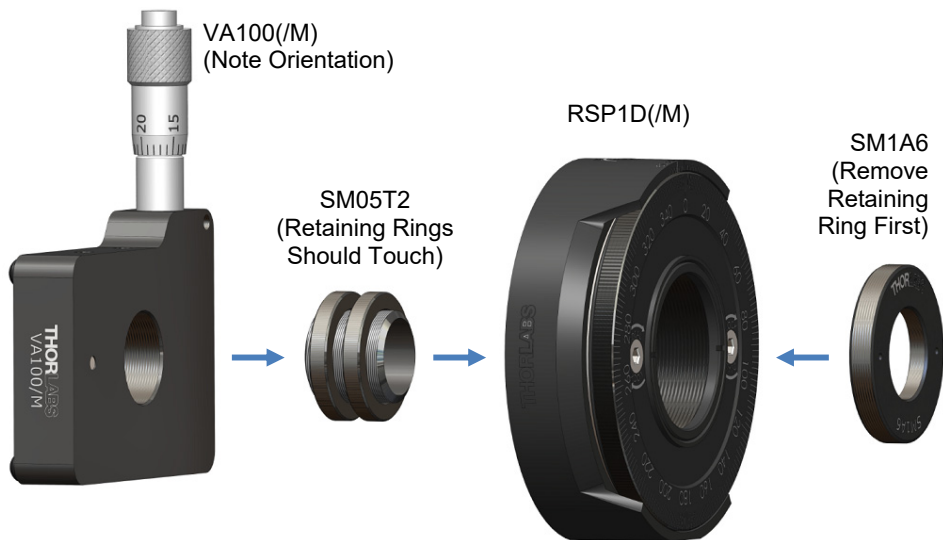

Figure 26: Assembly of the Rotating Slit

5.2. Camera Installation and Settings

Download Thorcam¹³ before installing and using the camera. Install the software.

A window for selecting the correct driver will pop up (see Figure 27). Left-click the “X” symbol next to “USB” and select “This feature will be installed on local hard drive.” The “X” symbol disappears as shown in Figure 27.

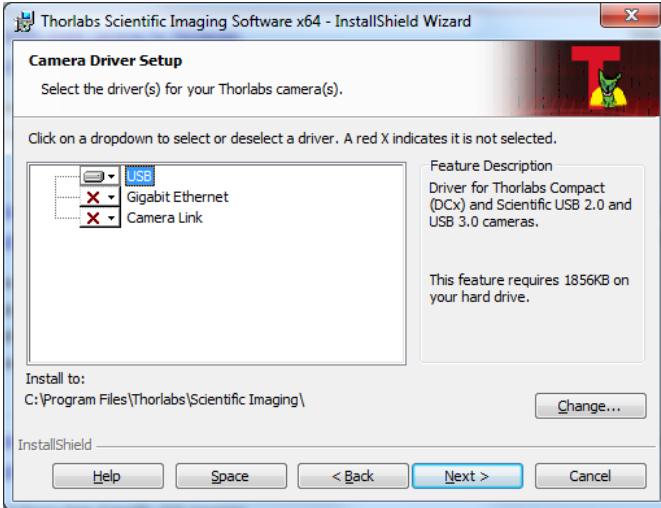

Figure 27: Selection During Installation

Finish the installation. Use the supplied USB cable to connect the camera to a free USB port on your computer. To turn on the camera, open the Thorcam program by double-clicking the corresponding icon. The interface shown in Figure 28 is displayed.

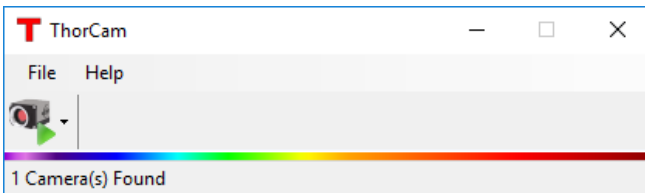

Figure 28: User Interface

Click the “Open Camera” button and select the camera with the corresponding serial number. The user interface shown in Figure 29 is displayed.

¹³https://www.thorlabs.com/software_pages/ViewSoftwarePage.cfm?Code=ThorCam

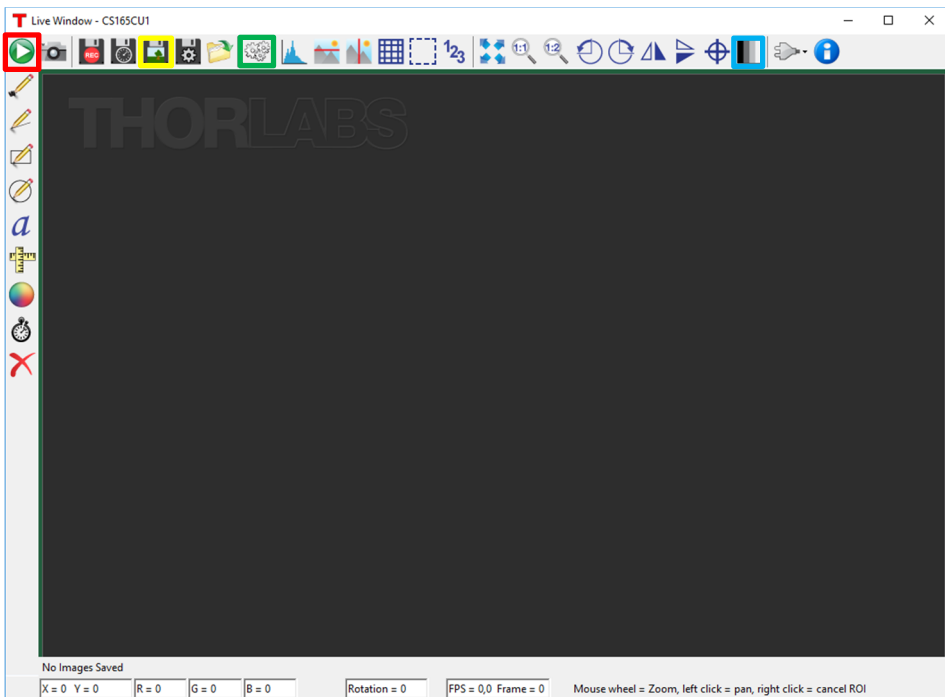

Figure 29: Camera Interface

Click the Live button (indicated in red in Figure 29) to display the live camera image in the window. Click the Save button (indicated in yellow) to open the dialog for saving the camera image to a file. Click the Settings button (indicated in green) and the Display button (indicated in blue) to open the camera menu, as shown in Figure 30, where you can change various settings such as the “Exposure Time”, “Gain” and the color scale.

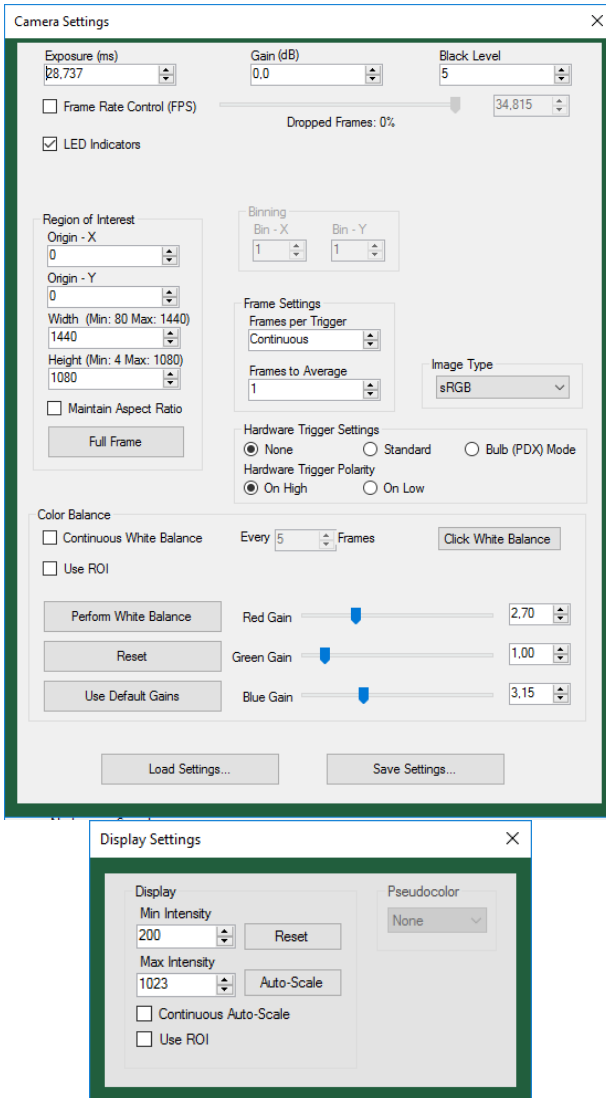

Figure 30: Camera and Display Settings

The correct exposure time and the optimal color scale will be set during the adjustment of the setup.

Now the camera is fully installed and ready to use.

5.3. Target and Mask

This is a sketch of the target supplied with this kit (outer diameter sector star: 3 mm):

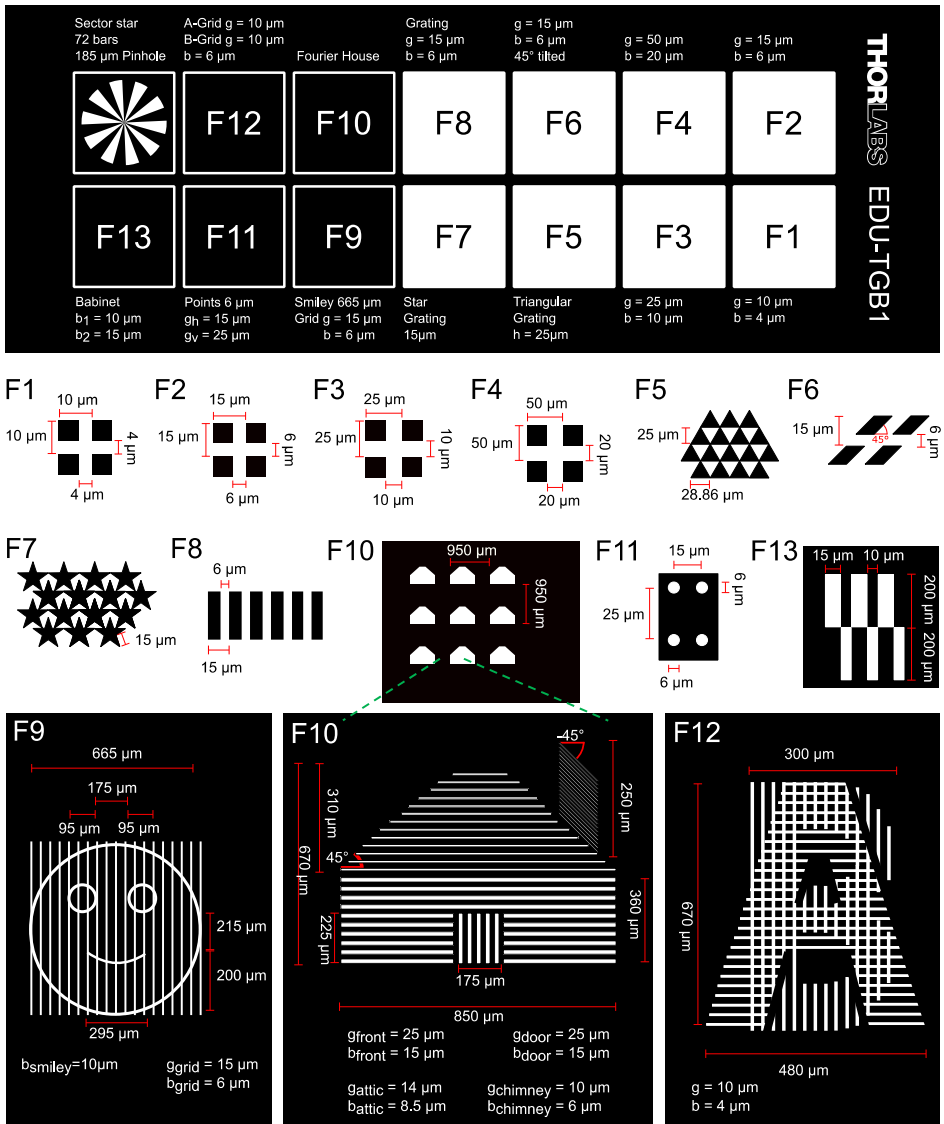

Figure 31: Target EDU-TGB1 with Detail Drawings for Each Section

Fields F10 and F12 feature an arrangement of nine identical structures, a house and the AB structure. The purpose of that is to increase the intensity in the Fourier plane. With only one structure, the pattern would be hardly visible on the screen. Since the houses are all identical, the Fourier plane for one house is essentially the same as the Fourier plane of an arrangement of 9 houses. To understand that, consider the point grating in field F11. The Fourier pattern is a convolution of the pin hole diffraction pattern and the pattern of a periodic, rectangular lattice. When only few pin holes are present (or a lot of pin holes are present in a random arrangement), the resulting Fourier plane is dominated by the pin hole diffraction pattern. Therefore, the arrangement of 9 houses or 9 ABs is also dominated by the Fourier pattern of the single house or the single AB.

In the next chapters, we will often reference the target's fields F1 to F14 from Figure 31. Since it is helpful to have a visual aid when changing between the different fields of the target, we will use the small diagram to the right to indicate which field to use for each exercise. The reference diagram is vertical since the target is installed vertically in its holder. For example, this diagram means that the user is supposed to choose the Triangular Grating from field F5 in Figure 31.



This is a sketch of the mask that is used in the Fourier plane to block portions of the diffraction pattern to alter the resulting camera image.

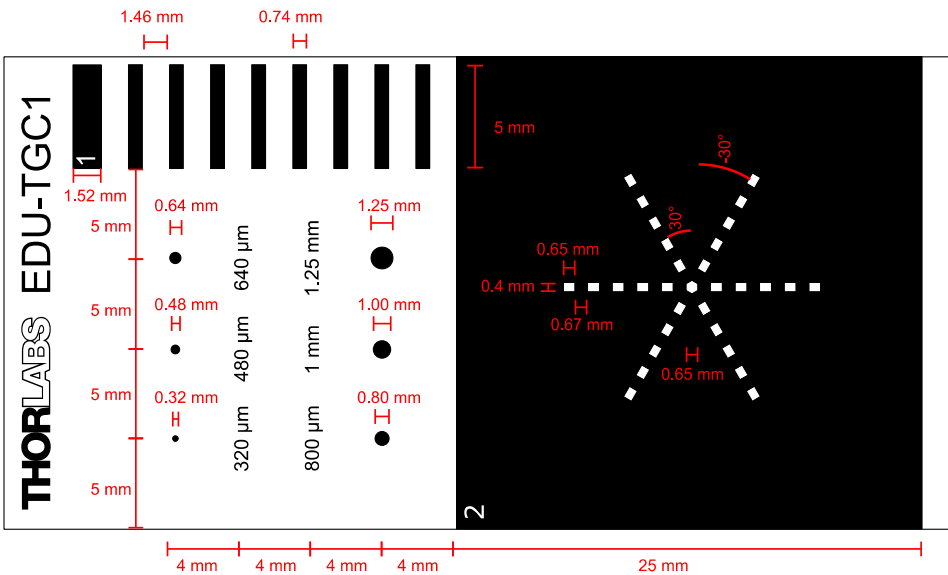

Figure 32: The EDU-TGC1 Cutting Mask: the red lines and red labels are not part of the mask.

5.4. Setup and Adjustment of the Experiment

This section describes the setup and alignment of the main experiment.

For students, however, we recommend starting with the introductory exercises in Section 6.1 to get acquainted to the system's parts and their individual function.

To prevent possible shifting of the components, we recommend securing all parts in their final place with the clamps and screws. Reset all camera settings before you start (see Figure 30). To ensure optimal clamping, the clamps should not protrude from the breadboard.

Step 1: Height Adjustment

- Set the height of all components to 10 cm using the LMR1AP alignment plate and a ruler, measured from the breadboard to the center of the optical element (filter mount flipped sideways).
- The maximum height that is allowed by the components is 11 cm; the minimum height is 9 cm (measured from the top of the breadboard to the center of the optical element).¹⁴

Step 2: Camera and Tube Lens

- Place the camera at the right end of the breadboard, facing along the 4th hole line counted from the long edge closest to the user.



Figure 33: Placement of the Camera

- Switch on the camera software and start the live camera image (see Figure 29).
- Place the tube lens ($f = 150$ mm) at approximately 150 mm from the camera chip along the same line of holes (see Figure 34).
- The next step is to get a sharp image of a faraway object onto the camera. Make sure the room is lit well, so you have a high enough intensity on the camera. Adjust the camera's exposure time to the lighting conditions in the room. To place the tube lens, you have three options, the first and second being the preferred methods (see Figure 34).

¹⁴ If you have chosen to setup on an optical rail instead of the breadboard, the center of the optical components should be 7 cm above the upper side of the rail.

1. Point your breadboard at an object on the other side of the room, preferably at least 4 m away. Move the tube lens forward and backward until you see a sharp image of the object on the camera.
2. If your environment prohibits you from pointing the breadboard at a wall that is a couple of meters away, you can use the beamsplitter to help. Place the beamsplitter (in the right orientation) about 10 cm away from the tube lens and close the transmitted beam path with a snap-on cap. Now the camera is “looking” perpendicular to the breadboard. Again, move the tube lens forward and backward until you see a sharp image of a faraway object on the camera. Make sure to secure the lens on the line of holes once it is aligned. Remove the beamsplitter.
3. If your environment prohibits you from obtaining a sharp image with the two methods described above (because you may be sitting in a very small room), you have a third option. This option, however, results in setting up the microscope with non-conjugate focal planes, meaning you will not get an infinity corrected microscope. This, in turn, will result in a different magnification of the sample (but you can still perform all experiments). Please refer to the end of this section for details on this alignment method (“Step 2: Modified”).

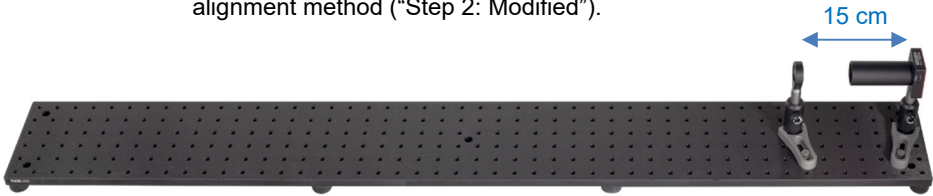

Figure 34: Placement of the Tube Lens

Step 3: Collimation and Adjustment of the LED

- Aim the LED at a wall or the ceiling and use the variable lens tube to position the collector lens so that you can see the LED chip (a pattern of black spots). Choose an LED intensity that allows you to see the pattern. Since the LED chip has a dome of plastic on it, you will not see a perfectly sharp image.¹⁵ When you have finished, tighten the locking ring on the variable lens tube.

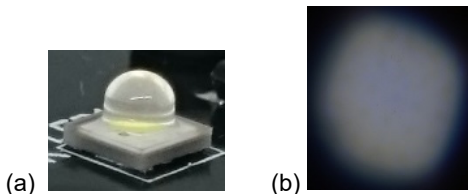

Figure 35: (a) Close-Up of LED Chip with Plastic Dome, (b) Pattern of Faint Black Spots Seen When the LED is Pointed at the Wall

- Place the observation screen behind the camera.
- Place the LED 100 cm away from the camera (distance from post to post) on the line of holes.
- Observe the shadow of the camera on the screen. The shadow may not be centered in the LED light cone. This can happen in the rare case that the LED chip is a bit off-center. *Do not change the height of the camera or the height of the LED.* Should you encounter an off-center spot, deal with it in the following way:
 - Rotate the LED in its SM1RC holder until the center of the light cone is either right or left of the camera shadow. There will be a lot of friction due to the yellow warning sticker on the LED. Tighten the SM1RC screw.
 - Simply turn the whole LED assembly until the camera shadow is in the center of the light cone. Mount it on the breadboard on the line of holes.

¹⁵ Using the term "collimation" in this context is a bit misleading. Mapping the chip on the wall does not mean the light source is ideally collimated, but seeing the chip helps with alignment, and the light is sufficiently collimated. Typically, the black spots will be visible for only about 1 to 2 full rotations of the variable lens tube.

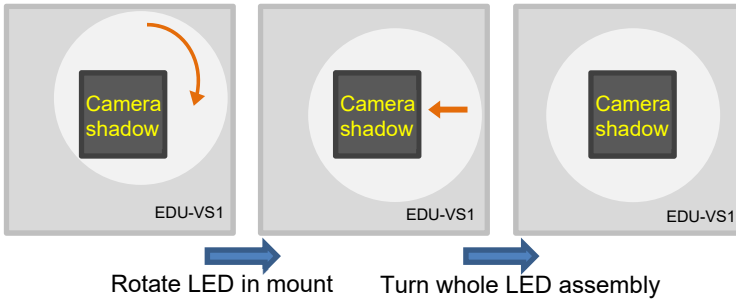

Figure 36: Centering the LED Light Around the Camera Shadow



Figure 37: Placement of the LED

Step 4: Objective Lens

- Place the objective lens ($f = 30$ mm) 18 to 20 cm away from the tube lens, measured from the center of the lenses. The correct lens orientation is depicted in Figure 24 and Figure 38.
- Attach it to the board with the clamp oriented as shown in Figure 38.
- Rotate the SM1ZM zoom housing, so that the lens can travel in both directions.

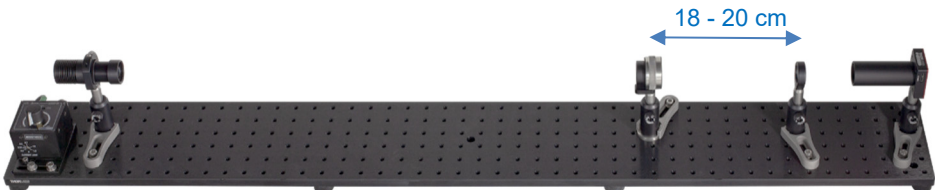

Figure 38: Placement of the Objective Lens; See Figure 24 for Lens Orientation

Step 5: Target

- Move the target up to the highest possible position by turning the height adjustment screw clockwise.
- Adjust the height of the post that holds the XYF1(/M) so that the sector star (lowest row on the target, field F14 in Figure 31) has the same height as your optical axis (10 cm according to Step 1).
- Make sure that the lens in the SM1ZM zoom housing is approximately in the middle of the SM1ZM's travel range.
- Place the target approximately 2 cm away from the objective lens mount. Move the target back and forth until you obtain a sharp image of the sector star in the camera. You may have to reduce either the light intensity of the LED or the exposure time in the camera settings to avoid saturating the camera (see Figure 39 and Figure 40).
- Make sure the target is perpendicular to the optical path. Fix the assembly onto the breadboard.
- If the camera image is not sharp, adjust the objective lens by rotating the SM1ZM zoom housing.
- Move the target with the two adjustment screws of the XYF1(/M) to field F10 (c.f. Figure 31), an arrangement of nine houses. Move the target until the center house is seen on the camera.
- Since the camera has a good sensitivity, you will always pick up some stray light. We suggest to set the minimum of the color scale (see Figure 30) to 200.



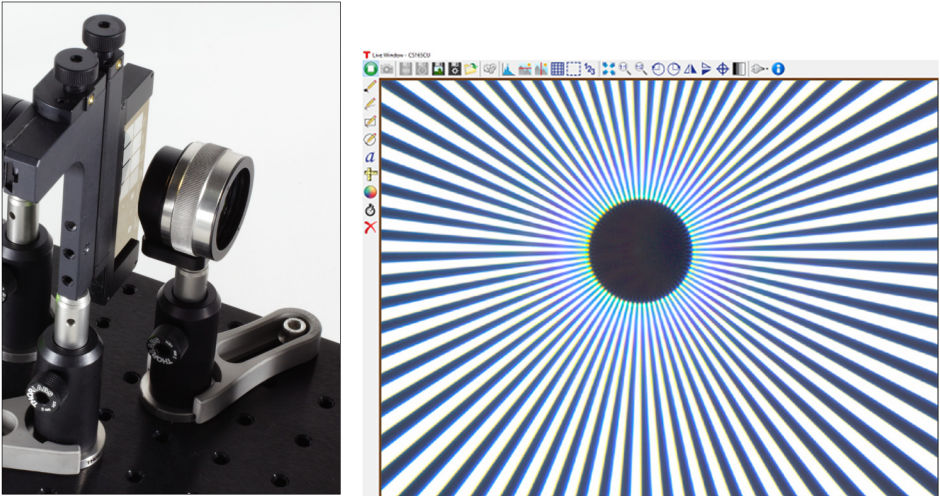

Figure 39: Placement of the Target and Image on the Camera (with 2 ms Exposure Time and Min Intensity 100, c.f. Camera and Display Settings)

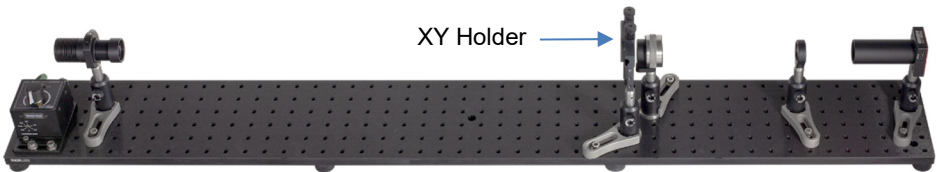

Figure 40: Placement of the Target in the XY Holder

Step 6: Condenser Lens

- Place the condenser lens ($f = 50 \text{ mm}$) 50 mm away from the target, measured approximately from the center of the lens (see Figure 41).
- Move the lens forward and backward and observe the spot size on the target. It can be helpful to hold a small piece of paper directly in front of the target, as shown in Figure 44. Reducing the LED intensity is often helpful as well.
- Adjust the location of the condenser lens to achieve the minimum spot size.
- Remove the piece of paper and make sure the spot is centered around the center house of the 9 house array on the target (field F10 in Figure 31). If that is not the case, adjust the lens height accordingly.

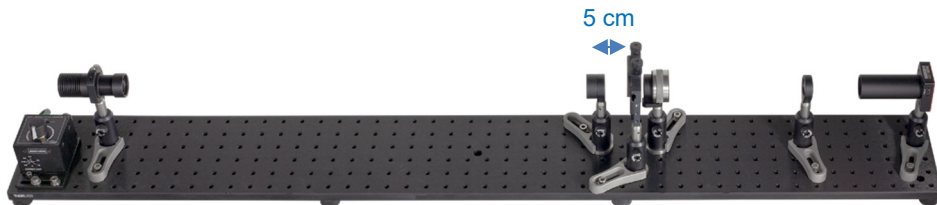

Figure 41: Placement of the Condenser Lens; See Figure 23 for the Lens Orientation

Step 7: Aperture Iris

- Place the aperture iris [the smaller one, ID12/(M)] approximately 50 mm away from the condenser lens, measured from the iris to the center of the lens (see Figure 42).
- Close the aperture iris and set the height so that the iris' shadow is centered on the condenser lens mount as shown in Figure 45 (the stray light at the lower edge of the lens mount is eliminated by the field lens in the next step).¹⁶

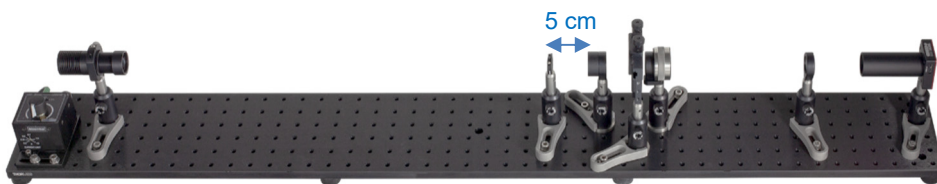

Figure 42: Placement of the Aperture Iris

Step 8: Field Lens

- Place the field lens ($f = 150$ mm) approximately 150 mm away from the aperture iris (see Figure 43).
- Place a piece of paper in front of the iris.
- Move the field lens until you see the LED chip on the paper (array of black spots). You may need to reduce the LED intensity to see the spots.¹⁷
- Check the height of the field lens. The spot on the aperture iris should be centered, see Figure 46.

¹⁶ When the iris is fully closed and in the focal plane of the condenser lens, then the light transmitted through the condenser should be collimated. You can check that by moving a piece of paper from condenser lens to target.

¹⁷ It can be difficult to see the LED chip. If you cannot see it, aligning the field lens so that it is 15 cm away from the aperture iris is sufficient.

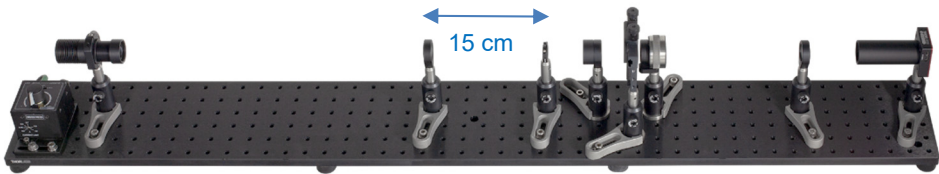

Figure 43: Placement of the Field Lens

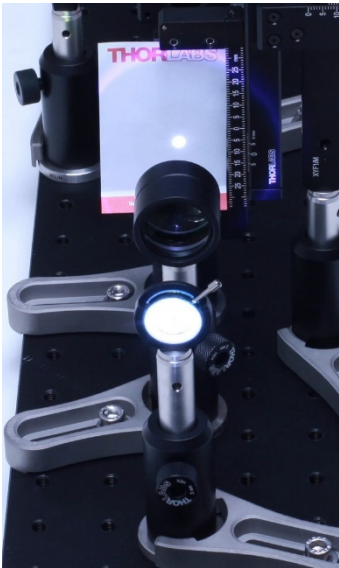

Figure 44: Light Spot on the Target During Positioning of the Condenser Lens

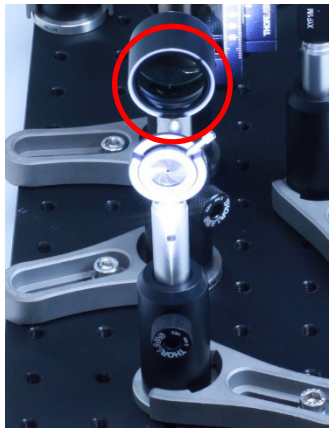

Figure 45: The aperture iris' shadow is centered on the condenser lens and its holder.



Figure 46: Positioning of the Field Lens and Field Iris

Step 9: Field Iris

- Place the ID25(/M) field iris at approximately 150 mm from the field lens (see Figure 47).
- Check the height of the iris by opening or closing the iris in order to verify that the field lens mount is illuminated evenly (by observing the mount itself or by using the LMR1AP alignment plate on the field lens mount).
- Almost fully close the iris.
- Observe the camera image and slightly move the iris forward and backward. Ideally, you would see a sharp image of the iris on the camera, meaning you

would be able to see the edges of the iris blades (roughly a polygonal shape). However, you cannot obtain a sharp image with this setup. Just make sure you see deviation from the circular shape (i.e., some bumps on the edges), as shown in Figure 48.

- If the light spot is not centered in the camera image, adjust the field iris' height.

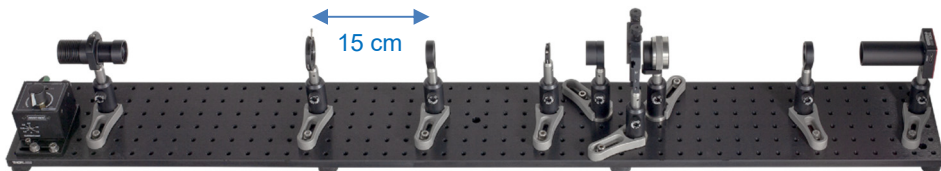

Figure 47: Placement of the Field Iris

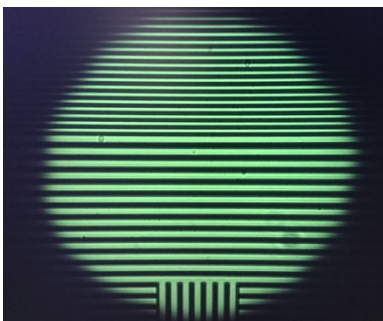

Figure 48: Place the field iris so that the camera image shows a sharp image of the field iris. Since this will rarely be the case, it is sufficient to place the lens such that you see a deviation from the circular shape.

Step 10: Color Filter

- With the mount flipped *sideways*, match the height of the color filter to the height of the collector lens in front of the LED.
- Place the color filter in front of the LED. The close proximity reduces the stray white light; see Figure 49.



Figure 49: Placement of the Color Filter

Step 11: Beamsplitter

- First, set the target to the grating with $g = 15 \mu\text{m}$ and $b = 6 \mu\text{m}$, field F2 in Figure 31.
- Open the field iris (about 3/4).
- Close the aperture iris.
- Place the beamsplitter approximately 8 cm away from the objective lens (distance measured between objective lens mount and beamsplitter mount). The orientation can be seen in Figure 21 and Figure 50. Do not place it too close to the objective lens or you will not have enough room to manipulate the Fourier plane.
- Close the side port of the beamsplitter that is facing the user with an SM1EC2B plastic cap.

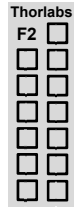

Figure 50: The holder of the beam splitter cube should not be illuminated.

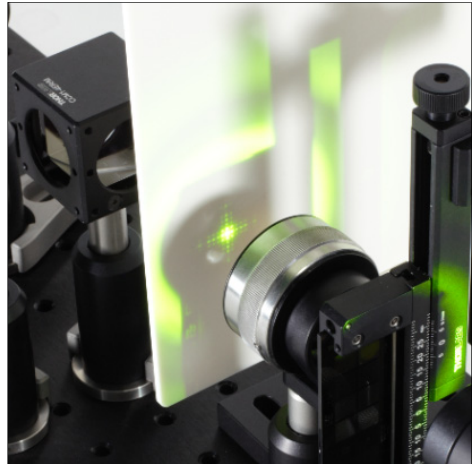

Figure 51: Examining the Fourier Plane Behind the Objective Lens

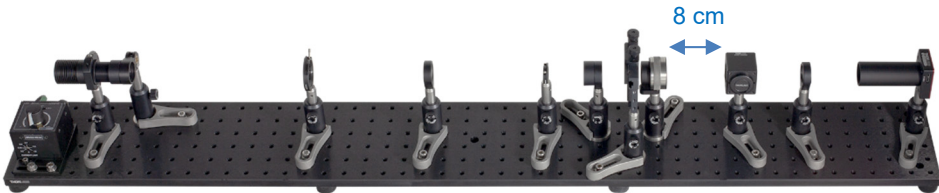

Figure 52: Placement of the Beamsplitter

Step 12: Fourier Plane

- Set the LED to full intensity.
- Use either a screen or piece of paper to find the Fourier plane behind the objective lens (in the focal plane), as shown in Figure 51 (aperture iris closed, field iris open). In the next step, this has to be displayed on the screen using the projection lens.

Step 13: Projection Lens and Viewing Screen

- Position the projection lens ($f = 75 \text{ mm}$) directly behind the beamsplitter (at a 90° angle to the optical path towards the camera) and fix it to the board.
- Use the viewing screen to find the distance where you see a sharp image of the Fourier plane on the screen.¹⁸
- If producing a sharp image of the Fourier plane on the screen is not possible, varying the distance between the projection lens and beamsplitter cube may help.
- General remark for the placement of beamsplitter, projection lens and viewing screen: When the screen is moved further away, the image gets larger. However, the projection lens will have to be closer to the beamsplitter to get a sharp image. If there is not enough space between the beamsplitter and projection lens to move it closer, move both the beamsplitter and projection lens closer to the objective lens. Make sure there is enough room between the objective lens and the beamsplitter for manipulating the Fourier plane.



Figure 53: Positioning of the Beamsplitter Cube, Projection Lens, and Viewing Screen

¹⁸ The distance to get a sharp image depends on the object distance g (Fourier plane to projection lens) and the focal length of the projection lens f , and is called the image distance b . It follows the lens equation $\frac{1}{f} = \frac{1}{b} + \frac{1}{g}$.

Step 14: Target Plane Correction

When the target is not placed perpendicular to the light path, there will be reflections on the glass that may appear as additional spots in the Fourier image. The reflections may show in the Fourier plane (double reflection in the glass) and in the light reflected towards the aperture iris.

- Observe the side of the aperture iris that faces the target. When the target is not perpendicular to the beam, you will get reflections similar to the ones in the photo on the right.
- Should these reflections be off-center, please rotate the target in its holder until the reflections align with the center of the iris.
- You may need to slightly move the objective lens in the SM1ZM zoom housing to get a sharp image on the camera again.

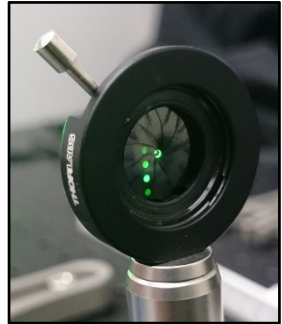

You should now see a sharp image of the target on the camera and a sharp image of the Fourier plane on the screen.

Step 2 Modified:

- As described in step 2, you can also set up the experiment without conjugate focal planes. You will get a different magnification but can still perform all experiments.
- Place the LED at the other side of the breadboard opposite to the camera.
- To correctly position the tube lens ($f = 150$ mm), set the target directly in front of the LED, as shown in Figure 54. Now move the tube lens to generate a sharp image of the target on the camera (use the letters on the target for orientation). Decrease the intensity of the LED as far as possible with the controller to avoid saturation of the camera. Alternatively, the exposure time of the camera can be reduced in the software settings. Do not forget to reset the exposure time.

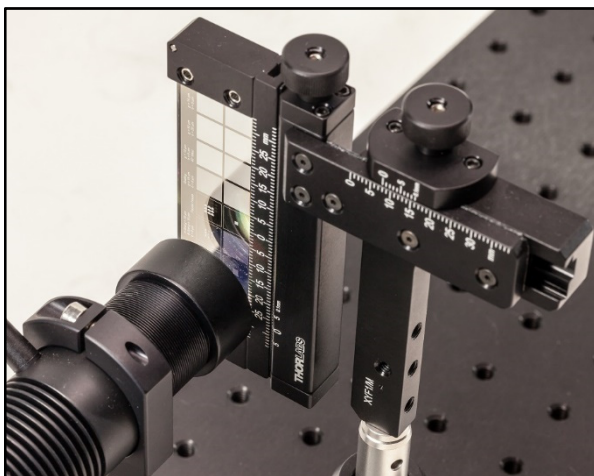

Figure 54: To correctly position the tube lens, position the target directly in front of the LED.

- Place the objective lens 18 to 20 cm away from the tube lens.
- All other steps follow the same procedure.

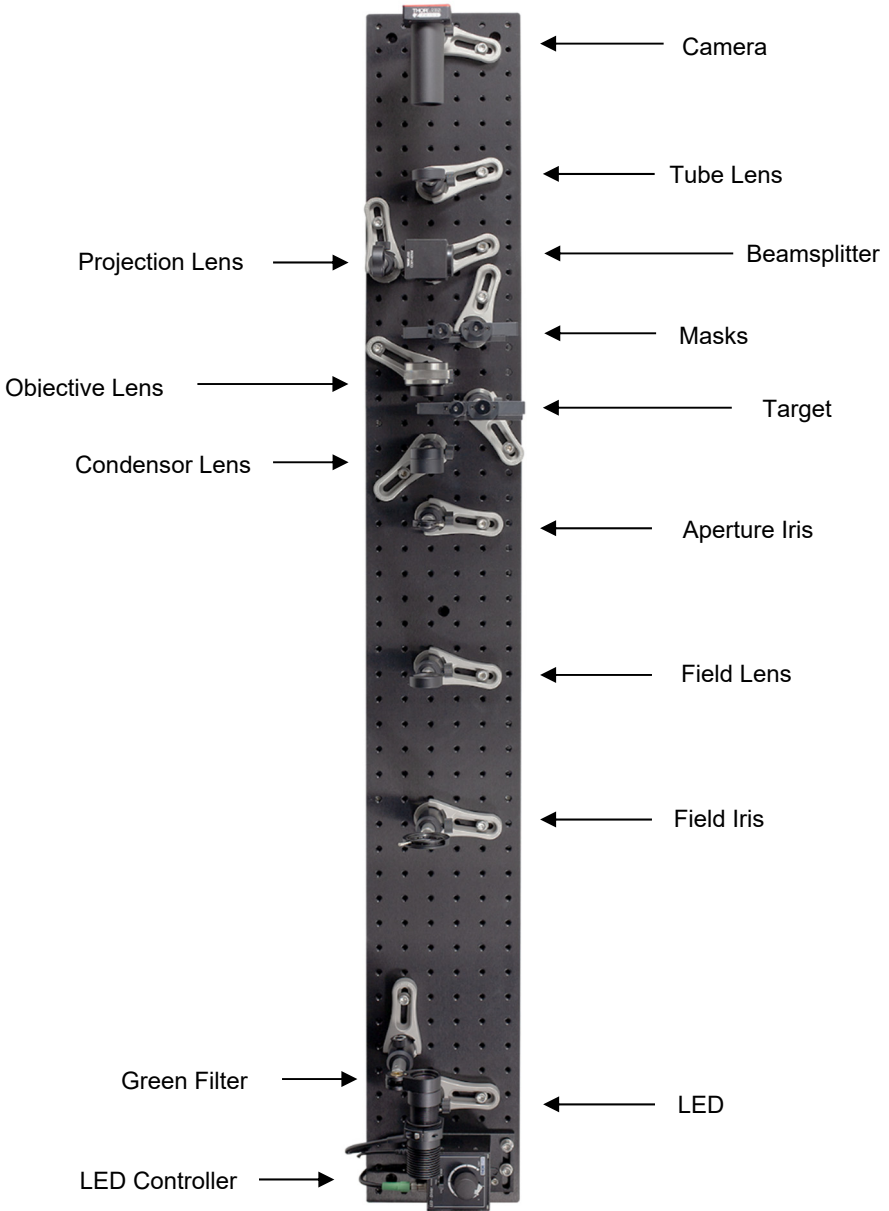

Figure 55: Adjusted Overall Setup

5.5. Function of the Individual Optical Elements



Figure 56: Overall Setup

Collector Lens: The collector lens is attached directly to the LED and ensures the best possible parallelisation of the light from the LED. This results in the greatest possible intensity on the smallest possible area.

Illuminating Optics: In principle, the combination of a field lens and condenser lens with coinciding focal planes is a Keplerian telescope. The lenses in this kit should provide threefold magnification. Since we are effectively using the telescope backwards with the field lens aimed at the light source, the illuminated area after the condenser lens only has one third the original area with the same overall intensity.

Imaging Optics: The combination of the objective lens and tube lens forms the imaging optics of the setup. It creates a sharp image of the object plane on the plane of the camera chip. Since the object is in one focal plane of the objective lens, the Fourier image of the object can be examined in the other focal plane of the objective lens. Fivefold magnification can be achieved when the focal planes of the lenses coincide. This setup is what is known as an infinity-corrected microscope. Since the target is in the focal plane of the objective lens, it can therefore be assumed that a parallel light beam is propagating behind the objective lens. Therefore, the tube lens can be set up at any distance from the objective lens to focus the image onto the camera.

Projection Lens: The Fourier image is in the rear focal plane of the objective lens. This plane (or the Fourier image) is displayed on a screen with the help of the projection lens via the beamsplitter. The display and magnification of the image follow the lens equation. When the projection lens is placed at a certain location, the image on the screen is only sharp at a certain screen distance. The magnification corresponds to the ratio of the image distance to the object distance.

Green Filter: The diffraction of white light on small structures leads to spectral splitting of the light in the diffraction pattern. A green filter is needed to prevent spectral splitting and therefore the expansion of the diffraction maxima in the Fourier image. Decreasing the extent of the diffraction maxima makes filtering the Fourier image easier. However, note that all diffraction effects shown here also occur with white light.

Field Iris: Opening and closing the field iris makes the illuminated area on the object behind the condenser lens larger or smaller. This is because the Kepler telescope

consisting of the field lens and condenser lens is positioned so that it projects a sharp image of the field iris in the object plane. Furthermore, changing the field iris opening can alter the brightness in the Fourier image: for example, when a cross lattice is illuminated, opening the field iris causes more gaps in the lattice to be illuminated. This in turn contributes more light to the formation of the Fourier image.

Aperture Iris: The intensity of light passing through the condenser lens can be controlled directly with the aperture iris. This means opening the aperture iris increases the intensity on the object because more light falls onto the condenser lens. Furthermore, the aperture iris is represented in the Fourier plane by the combination of the condenser lens and objective lens. Thus, the Fourier image is an overlay of the aperture iris image and the diffraction pattern of the object. This means the opening of the aperture iris correlates with the extent of the intensity maxima in the Fourier image.

Chapter 6 Exercises and Examples

This chapter is structured the following way:

- Chapter 6.1: A set of preliminary exercises uses sub-configurations of the Fourier Optics setup to demonstrate the purpose of different components in the setup. Students explore how the individual lenses work together to map images onto different planes.
- Chapter 6.2: After assembling the full Fourier Optics Kit, a set of introductory exercises deals with observing the individual function of each element in the setup.
- Chapter 6.3: This is the core of the Fourier Optics setup. The exercises here deal with the various ways that filters in the Fourier plane affect the final image.
- Chapter 6.4: Babinet's Principle is demonstrated with a number of exercises.
- Chapter 6.5: Since the methods of Fourier transformation are often used in modern image manipulation techniques, we demonstrate how image editing such as blurring works with Fourier Optics.
- Chapter 6.6: Specially designed targets allow an image to be displayed in the Fourier plane. This is demonstrated in the setup.
- Chapter 6.7: Small structures result in large diffraction patterns in the Fourier plane. This directly leads to Abbe's fundamental principle of microscope resolution. An example is demonstrated with the setup.

Advanced students that are familiar with microscopy and Köhler illumination may skip Chapter 6.1. For other students, we recommend performing these preliminary exercises first to understand the whole Fourier setup.

6.1. Preliminary Tests

Exercise 1: Place first the field lens ($f = 150 \text{ mm}$) and then the condenser lens ($f = 50 \text{ mm}$) in front of the collimated LED so that the focal planes coincide. Position the target in the LED-side focal plane of the field lens (so that at least one character is illuminated) and examine the image in the rear focal plane of the condenser lens with the observation screen. What optical device is created by the combination of the field lens and condenser lens?

Execution: The image of the target is upside-down and one third the size of the original target (the target should be set up so that at least one of the characters can be recognized). The combination of the field lens and condenser lens is a Keplerian telescope with a magnification $V = \frac{f_{\text{field}}}{f_{\text{condenser}}} = \frac{150 \text{ mm}}{50 \text{ mm}} = 3$. Since the light passes through the lens with a long focal length first and then through the lens with a short focal length, the light is effectively passing through the telescope backwards making the image 1/3 the size of the object.

When the full setup is assembled, the field and condenser lens form a Keplerian telescope that images the field iris on the target. This explains the direct effect that opening and closing the field iris has on the target. The intensity of light on the target also increases through imaging with the field lens and condenser lens, since the illuminated area gets smaller but the power remains the same.



Figure 57 Photo of the Image on the Screen Created by the Keplerian Telescope Formed by the Field Lens and the Condenser Lens

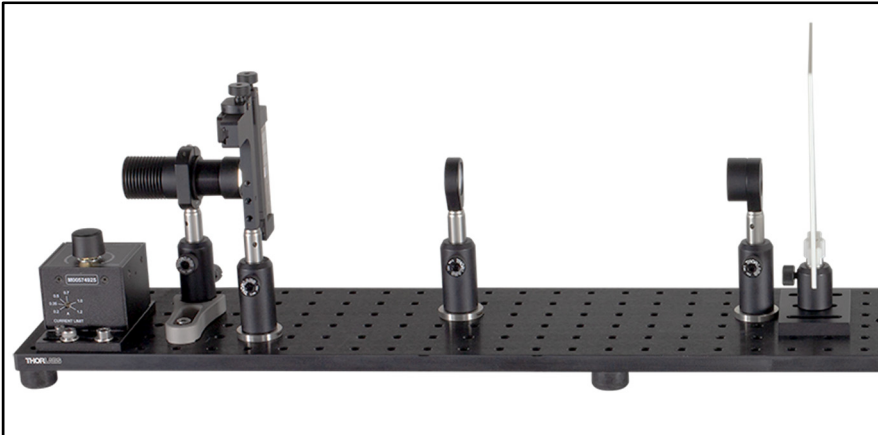

Figure 58: The Field Lens and the Condenser Lens Form a Keplerian Telescope With a Magnification of 1/3

Exercise 2: Place the objective lens ($f = 30 \text{ mm}$) behind the condenser lens ($f = 50 \text{ mm}$) so that the focal planes coincide. Position the target in the LED-side focal plane of the condenser lens and examine the image in the rear focal plane of the objective lens. What makes the combination of the condenser lens and objective lens different from the combination of the field lens and condenser lens?

Execution: The image of the target is upside-down and three fifths the original size (the target should be set up so that at least one of the characters can be recognized). The combination of the condenser lens and objective lens is a Keplerian telescope with a magnification $V = \frac{f_{\text{condenser}}}{f_{\text{objective}}} = \frac{50 \text{ mm}}{30 \text{ mm}} = \frac{5}{3}$. Since the light first passes through the lens with a long focal length and then through the lens with a short focal length, the displayed image is $3/5$ the size of the object.

When the full setup is assembled, the condenser lens and the objective lens form a Keplerian telescope that images the aperture iris in the camera-side focal plane of the objective lens. As we show experimentally in the Chapter 6.3, this plane is the Fourier plane. This explains why closing the aperture iris changes the Fourier image.



Figure 59: Photo of the Image on the Screen Created by the Keplerian Telescope Formed by the Condenser Lens and the Objective Lens

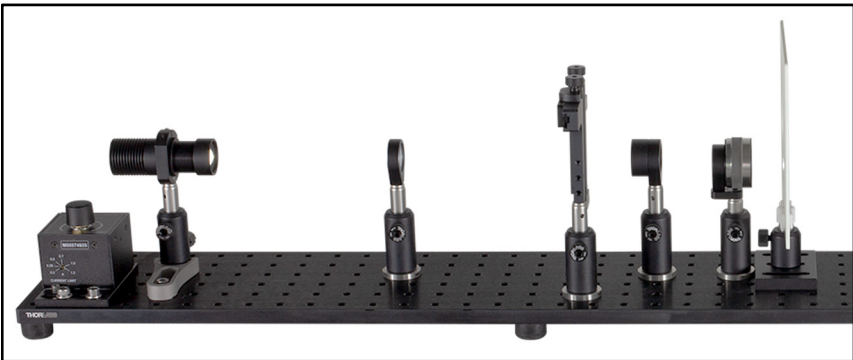

Figure 60: The Condenser Lens and the Objective Lens Form a Keplerian Telescope With a Magnification of $3/5$

Exercise 3: Now position the projection lens ($f = 75$ mm) behind the objective lens ($f = 30$ mm) so that a sharp image of the camera-side focal plane of the objective lens is visible on an arbitrarily positioned screen.

Execution: The image of the objective lens focal plane on the screen obeys the lens equation $\frac{1}{f} = \frac{1}{b} + \frac{1}{g}$. When necessary, the image distance can be calculated using the lens equation when the focal length and object distance are given. This time the image on the screen is right side up and shows the target. The size of the projection depends on the proportion of the image distance to the object distance.

Thus, the projection lens forms a sharp image of the rear objective lens focal plane on the screen. Since the Fourier image is found in the focal plane of the objective lens in the subsequent setup, the projection lens later displays the Fourier image on the screen. However, positioning the beamsplitter between the objective lens and projection lens deflects the existing beam path. It is therefore possible to see the projection of the Fourier plane on the screen and simultaneously the microscopy image on the camera. Since the target stands in the LED-side focal plane of the objective lens in the final setup (the image is created in the infinite), a tube lens is needed to focus an image of the target onto the camera.

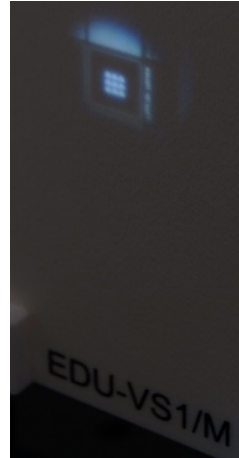

Figure 61: A lens projects the image in the objective's camera-side focal plane onto a screen.

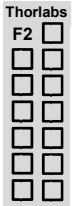

Figure 62: A lens projects the image from Exercise 2 onto a screen. In the Fourier Setup, this corresponds to the Fourier plane that is projected onto the screen (via the beamsplitter) since the camera-side focal plane of the objective lens is the Fourier plane.

Note: At this point, students should dismantle the setup and follow the assembly instructions in Chapter 5. In theory, it would be possible to install the setup exactly in the sequence described above. However, it turns out that this method is very inaccurate in practice and does not lead to a sharp image on the camera.

6.2. Introductory Tasks

Exercise 4: Adjust the setup according to the instructions in Chapter 5. A lattice (e.g., the $g = 15 \mu\text{m}$, $b = 6 \mu\text{m}$ lattice in the top row, field F2 in Figure 31) should be visible in the camera image. The Fourier plane should appear sharp on the screen.



Execution: See section 5, subsection 5.4.

Exercise 5: What roles do the irises play? Observe the effect that opening either the field iris or the aperture iris has on the image, the Fourier image, and the illumination of the object.

Execution:

Effect	Action	
	Opening the Field Iris	Opening the Aperture Iris
Effects on the Camera Image	Enlarges the visible area in the camera image. If the visible area is as large as or larger than the camera chip, opening the field iris has no further influence on the camera image.	Increases the brightness in the camera image.
Effects on the Illumination of the Target	Enlarges the illuminated area on the target.	Increases the brightness on the target.
Effects on the Fourier Image	Causes larger areas of the structures on the target to be illuminated. This increases the brightness in the Fourier image.	The extent of the intensity maxima in the Fourier image changes because the aperture iris is displayed in the Fourier plane by the Keplerian telescope consisting of the condenser lens and objective lens.

Exercise 6: Select a lattice of your choice in the object plane. Now use a sheet of paper or the screen to find the Fourier plane.

Execution: The Fourier plane is the camera-side focal plane of the objective lens. It is at the distance $d = 3 \text{ cm}$ from the objective lens. To view the intensity maxima in the Fourier plane separately and with maximum intensity, the aperture iris should be closed and the field iris opened.

Exercise 7: Select the houses as the target, field F10 in Figure 31. Place the screen directly behind the projection lens. Slowly move it away. What do you observe?

Execution: Not too far away from the projection lens, you should see a sharp image of the houses, field F10 in Figure 31. Further away, the image gets less sharp and finally becomes the diffraction pattern until you find the plane where the sharp diffraction pattern can be observed. So the projection lens does not only map the Fourier plane onto the screen, it also maps the image onto a plane close to it. (That's not surprising because that's exactly what the tube lens does for the camera, but it's still noteworthy that the object plane can be observed in the reflected arm as well.)



6.3. Filtering

In the following exercises, we will observe the effect that filters in the Fourier plane have on the camera image. For consistency, we will always show the camera image without the filter first in the upper left image. The corresponding Fourier plane is shown next to it. In subsequent rows, the left side will show the Fourier plane after a mask has been applied, while the image to the right shows the resulting camera image.

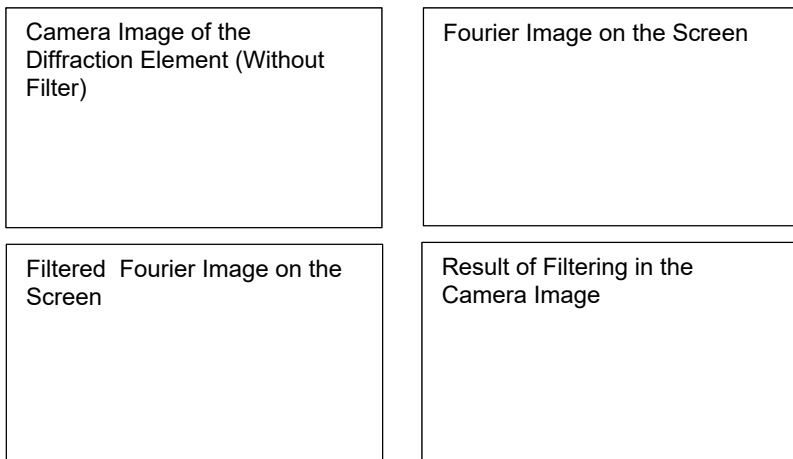

Figure xy

Exercise 8: Position a cross lattice (for instance the cross lattice with $15\ \mu\text{m}$ lattice constant, field F2 in Figure 31) in the object plane and adjust the objective lens if necessary so the camera image is sharp. Position the variable slit in the Fourier plane. Align the central bright spot to the center of the slit in both horizontal and vertical directions. Now adjust it so that light can only pass in a horizontal line along the main maximum. What is the result in the camera/microscope image and why?



Execution: Shift the target with the help of the x-y holder until a cross lattice is visible on the camera. The projection of the Fourier plane can be seen on the screen. Place the adjustable single slit in the Fourier plane behind the objective lens. (**TIP:** (1) The adjustable slit is exactly in the Fourier plane when the projection on the screen shows a sharp image of the slit. (2) Alternatively, one can observe the extent of the intensity maxima on the edges of the single slit.) Slowly close the adjustable single slit until only a horizontal row of intensity maxima is shown on the screen. Now the camera image shows a line lattice with an orientation that is rotated 90° to the orientation of the intensity maxima. The information about lines with different orientations in the lattice was blocked in the Fourier plane by the adjustable single slit. If necessary, you can adjust the brightness by opening or closing the aperture iris.

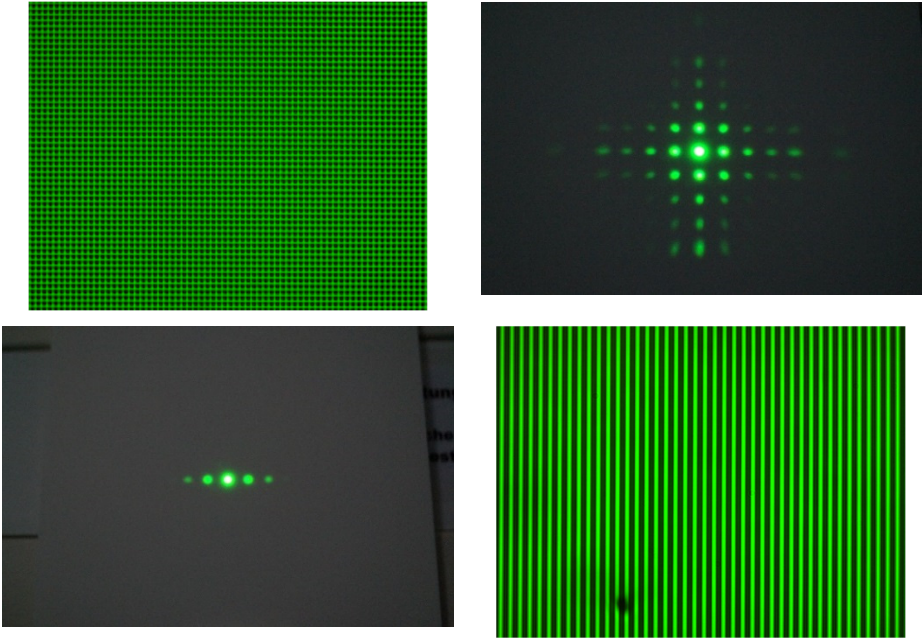

Figure 63: Cross Lattice Filtering 1

Exercise 9: Now turn the slit 90° and once again allow light to pass only along the vertical line of the main maximum. What camera image do you expect?

Execution: The orientation of the visible line lattice on the camera has also rotated 90° . Now the lines are horizontal. If necessary, you can adjust the brightness by opening or closing the aperture iris.

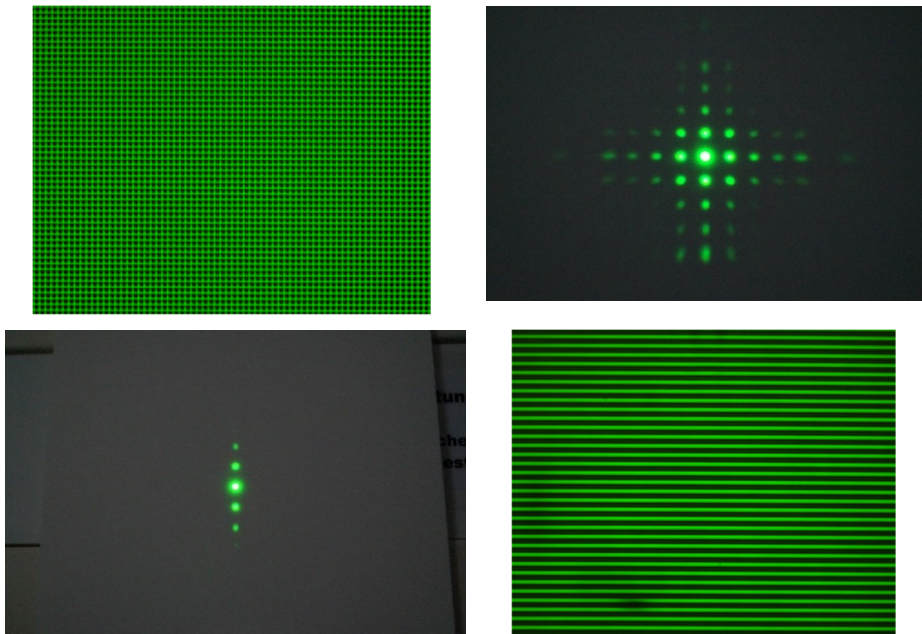

Figure 64: Cross Lattice Filtering 2

Exercise 10: Now rotate the slit to a 45° angle and only let the light of the main maximum and the corresponding diagonal orders pass. What is the resulting image on the camera and why?

Execution: Since all information about lines with a horizontal and vertical orientation is blocked by the adjustable single slit and only the information on a diagonal in the Fourier image passes, the camera image shows a diagonal line lattice rotated by 90° to the slit orientation. You should close the slit further and adjust the brightness by opening or closing the aperture iris if necessary.

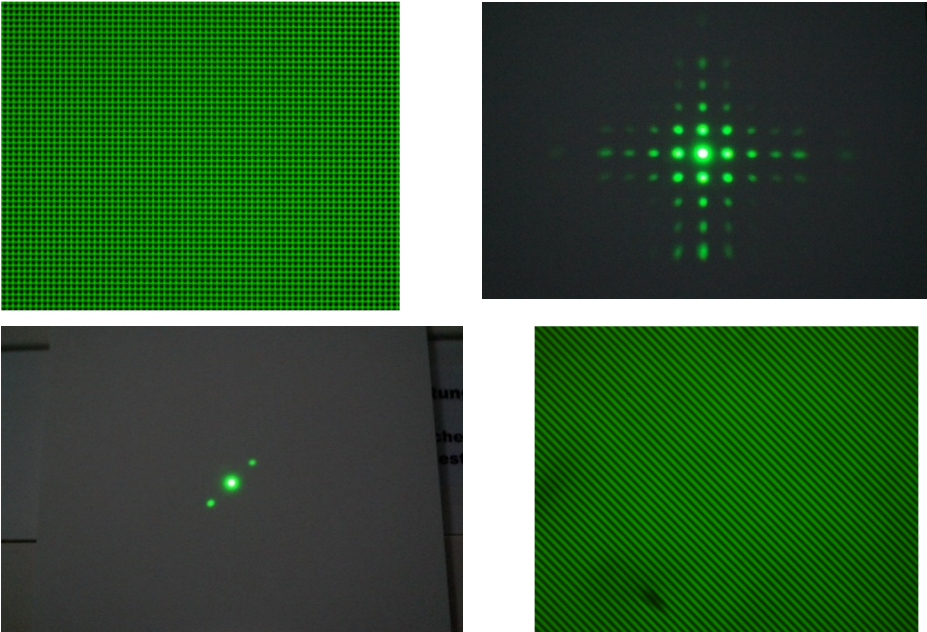

Figure 65: Cross Lattice Filtering 3

Exercise 11: Position the rotated cross lattice (45° tilted, field F6 in Figure 31) in the object plane and, with the variable slit, generate a line lattice on the camera that is not discernible in the structure on the target.



Execution: Examine the rotated cross lattice with the camera. The lattice in question, which is not immediately apparent in the structure, is a vertical line lattice. Turn the adjustable single slit to a horizontal orientation and close it further if necessary. The camera image shows the vertical line lattice in question.

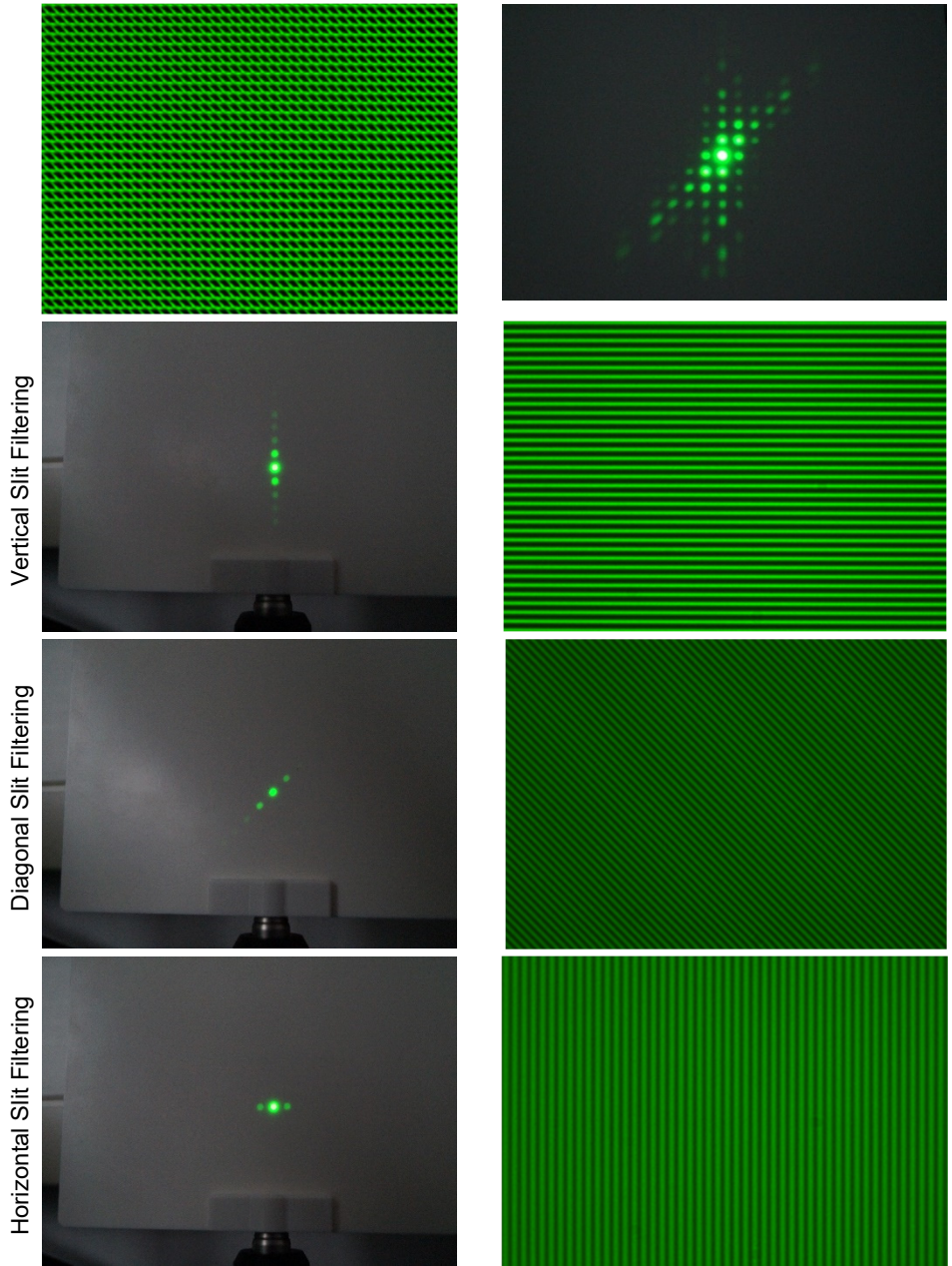

Figure 66: Rotated Cross Lattice Filtering

Exercise 12: Position the star grating in the object plane (field F7 in Figure 31) and adjust the objective lens if necessary so the camera image is sharp. Various line lattices can be generated by placing the variable slit in the Fourier plane and rotating it. Explain how the five line lattices are generated and why their lattice constants are different.



Execution: Since the stars are made up of five lines with different orientations, a maximum of 5 line lattices with different orientations and lattice constants can be displayed. It is discernible with the naked eye that parallel lines of two neighbouring stars are at different distances. This is where the different lattice constants come from. Place the adjustable single slit in the Fourier plane behind the objective lens. Adjust the size of the slit to a fixed value that makes it possible to see a line lattice. Now slowly rotate the single slit by hand and examine the camera image at the same time. If necessary, you can adjust the brightness by opening or closing the aperture iris. Figure 67 shows the 5 lattices of the stars and their different lattice constants.

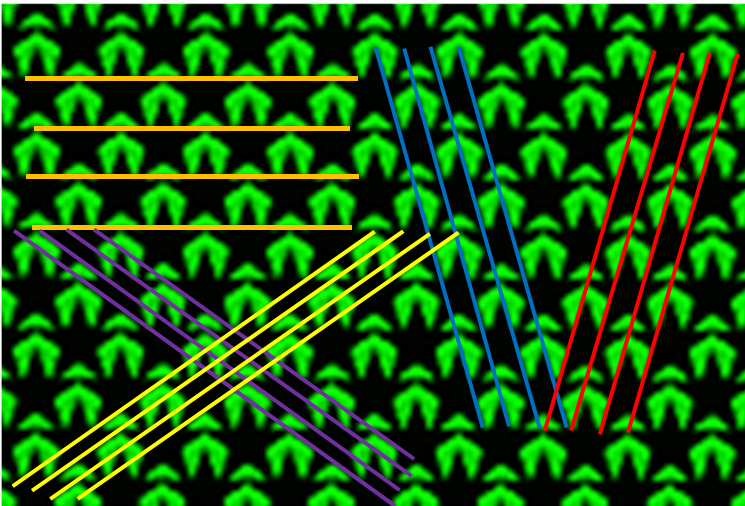

Figure 67: Different Lattice Planes in the Star Pattern

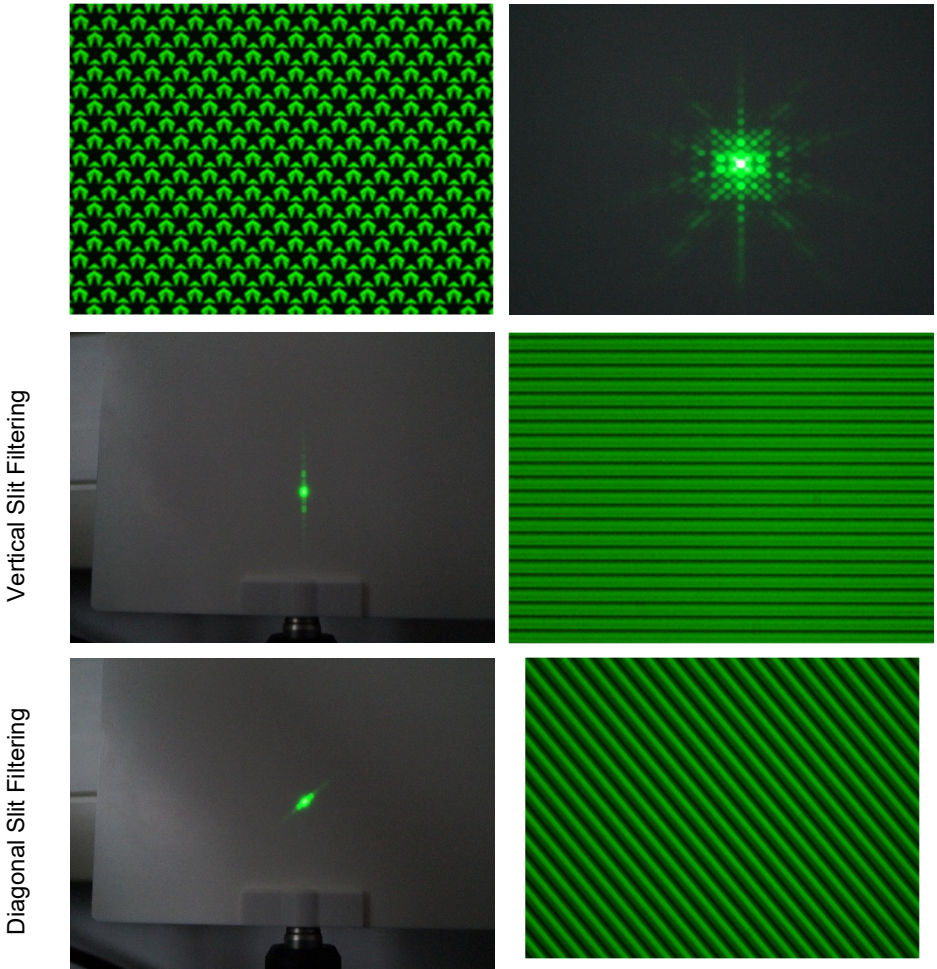
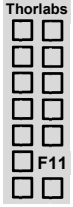

Figure 68: Star Filtering

Exercise 13: Position the point lattice in the object plane (field F11 in Figure 31) and adjust the sharpness with the objective lens if necessary. Place the variable slit in the Fourier plane and rotate it. Also vary the slit width while doing so. What do you observe and why?



Execution: Due to the regularity and symmetry of the point lattice Fourier image, a line lattice can be made visible in almost any orientation. The adjustable single slit has to be rotated in the Fourier plane to do so. The slit width and opening of the aperture iris may have to be adapted to make all line lattices visible.

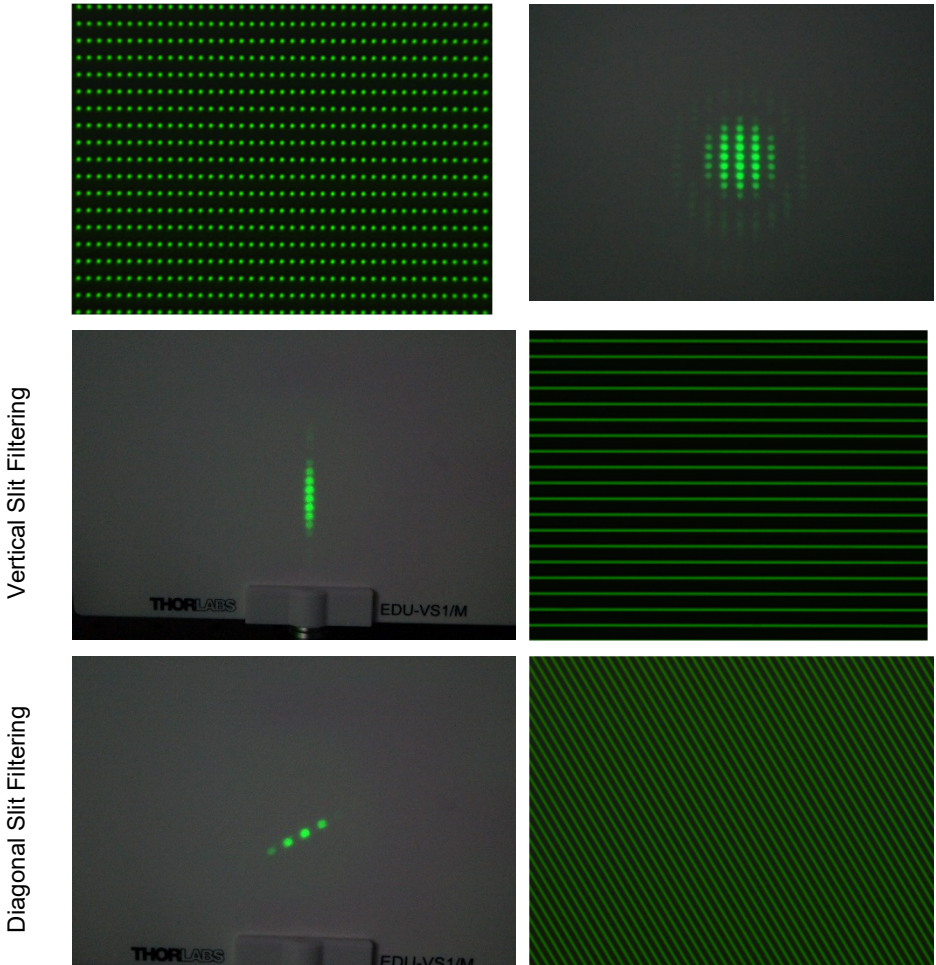
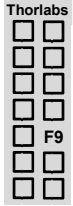

Figure 69: Point Lattice Filtering

Exercise 14: Position the “smiley behind bars” in the object plane (field F9 in Figure 31) and adjust the focus of the objective lens to sharpen the camera image if necessary. Now filter in the Fourier plane with the help of the variable slit so that the smiley is freed.



Execution: The Fourier plane shows the distribution of intensity maxima typical for line lattices. The information about the smiley’s structure is contained in the main maximum. When all intensity maxima of the line lattice with the exception of the main maximum are masked by the adjustable single slit, only the information about the smiley’s structure is retained and reaches the camera. The camera image shows the freed smiley.

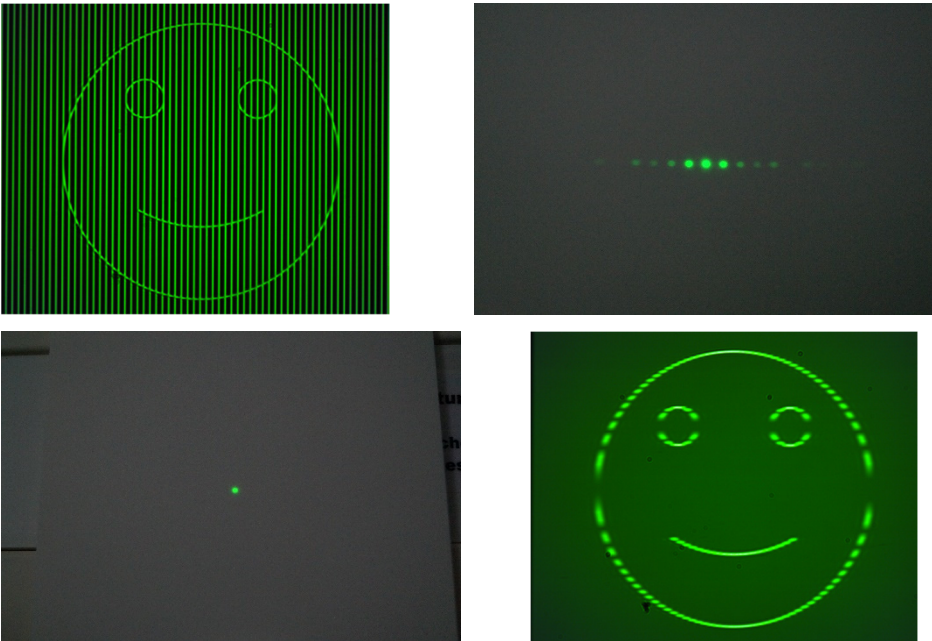

Figure 70: Smiley Filtering

Note, that the vertical line segments of the smiley are missing. This is due to the fact that they coincide with the lattice (and not because they are parallel to the lattice!). If the smiley was moved slightly to the left or right with respect to the lattice, these line segments would show (however, the next exercise would not work as well).

Students might ask why the zeroth order carries information. That is not the case: the frequencies carrying the information are simply very close to the first order spot and cannot be distinguished by eye.

Exercise 15: Demonstrate that you can also make the smiley disappear.

Execution: Rotate the variable slit by 90° . Close it so only the diffraction pattern of the grating passes.

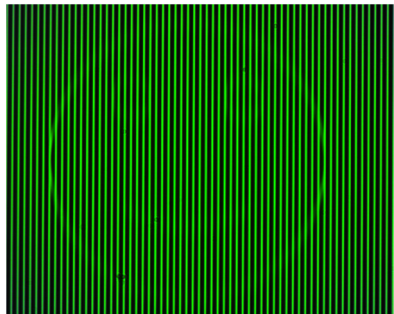

Figure 71: Filter out the Smiley with a Horizontal Slit (Left) and the Resulting Image (Right)

Exercise 16: Allow only the first order to pass the slit. What do you expect to see? Do the same with the second order.

Execution: Move the variable slit from the center of the Fourier pattern to one of the first orders on either side of the central maximum. You see a smiley as well. This is also the case for the second order when you move the slit accordingly (you may have to adjust the aperture iris).

Each point of the pattern in the Fourier plane contains the information about the smiley. When only one point of the pattern is allowed to pass, the information about the lattice is lost but the information about the smiley is still contained. The images for first and second order do not look the same due to different phases.

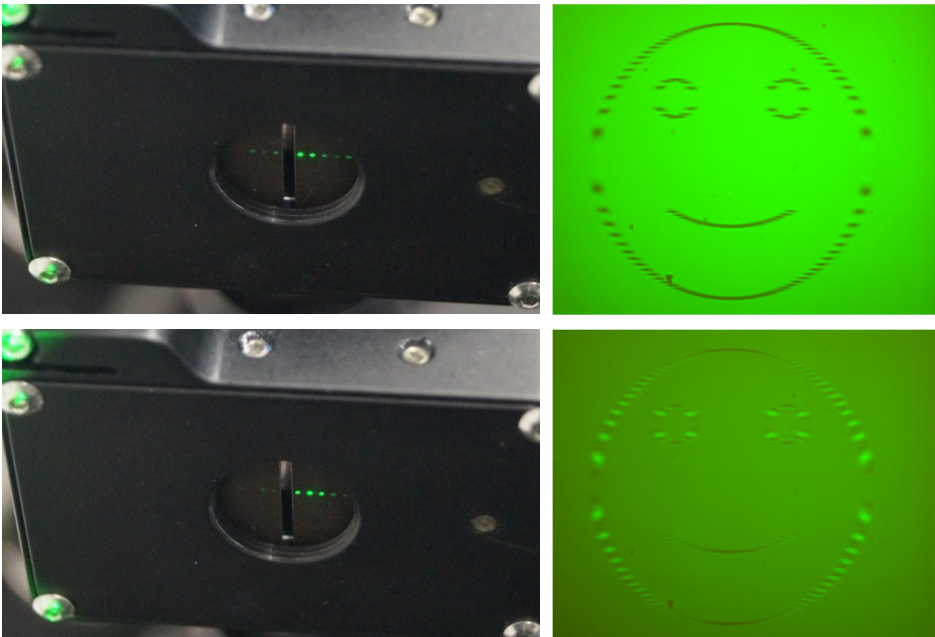

Figure 72: Above are the first and second order of the smiley+grating diffraction pattern. The images on the left show which order passes through the variable slit, while the images on the right show the resulting camera image.

Exercise 17: Position the overlapping letters “A” and “B” in the object plane, field F12 in Figure 31. By adjusting the variable slit accordingly, make the lattice structure of one or the other letter disappear. Why is the respective masked letter still slightly visible anyway?



Execution: The Fourier plane shows intensity maxima similar to a cross lattice. By filtering in the horizontal or vertical direction, the lattice structure of one of the two letters can be masked. Nevertheless, the letter remains visible as an evenly illuminated area. The information about the approximate shape of the letters is stored in the main maximum and is not influenced by filtering the lattice maxima.

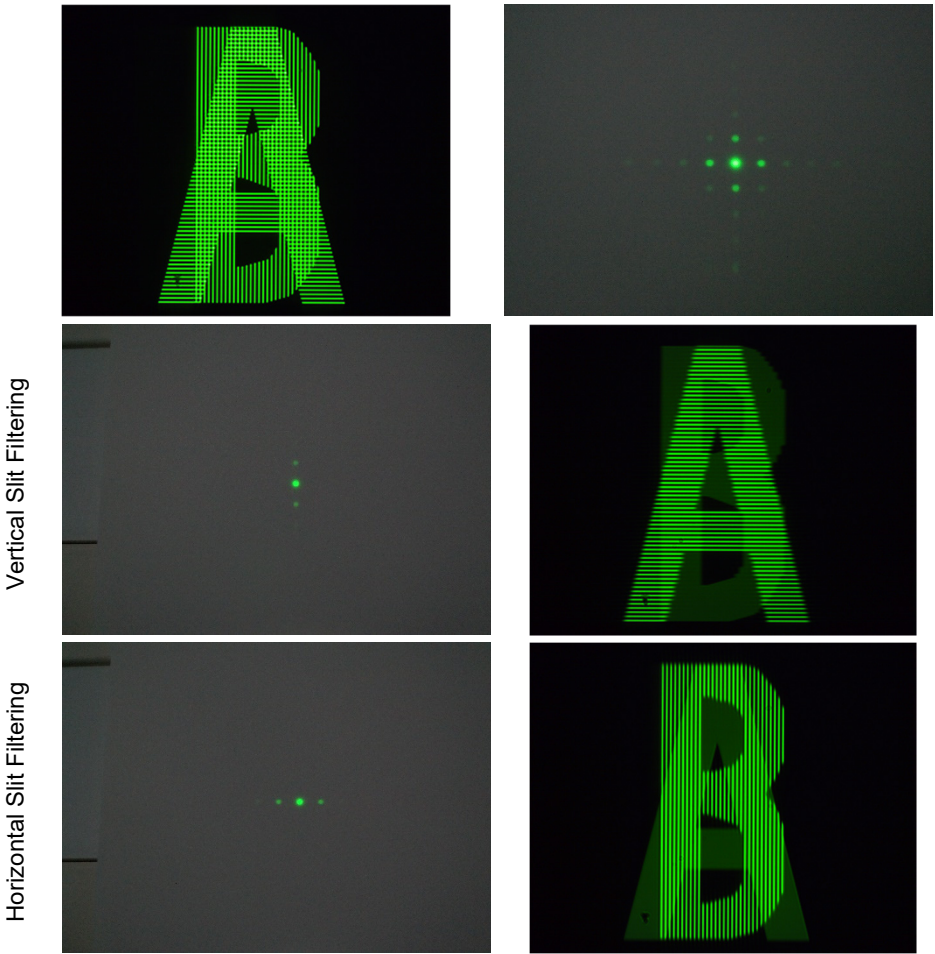

Figure 73: A-B Filtering

Exercise 18: Adjust the variable slit so that only the overlap of the letters “A” and “B” is visible. Which orientation does the resulting lattice have?

Execution: To show the overlap, one needs diffraction orders of both the vertical and the horizontal lattice. The slit needs to be in 45° orientation, and the filtered image will show this:

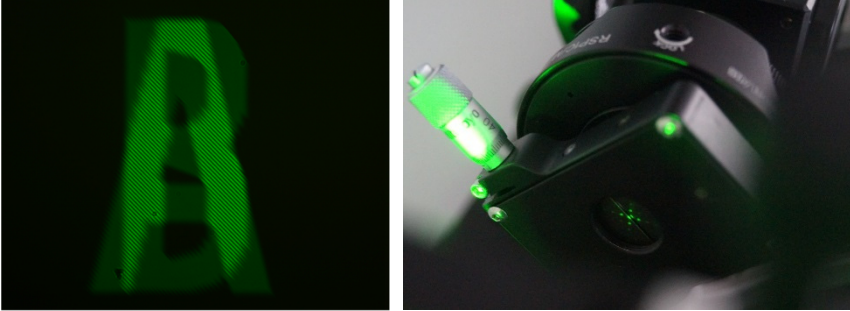

Figure 74: Overlap of “A” and “B” Letter on Left and 45° Slit Orientation on Right

Exercise 19: Position the field with the Fourier house in the object plane (field F10 in Figure 31) and adjust the sharpness if necessary. Now examine the Fourier plane. Rotate the variable slit to block different sections of the diffraction pattern. Find out which orientations change the camera image of the door, the attic, the front of the house, and the chimney, respectively.



Execution: The Fourier image shows intensity maxima of various orientations. Here the horizontal maxima represent the door of the house and the diagonal maxima the chimney. In the vertical direction, two patterns are overlaid with different distances between the maxima. The maxima with small distances between them are assigned to the front of the house, while the maxima with the large distances represent the attic. Different aspects of the Fourier house can be masked by changing the width and orientation of the adjustable single slit.

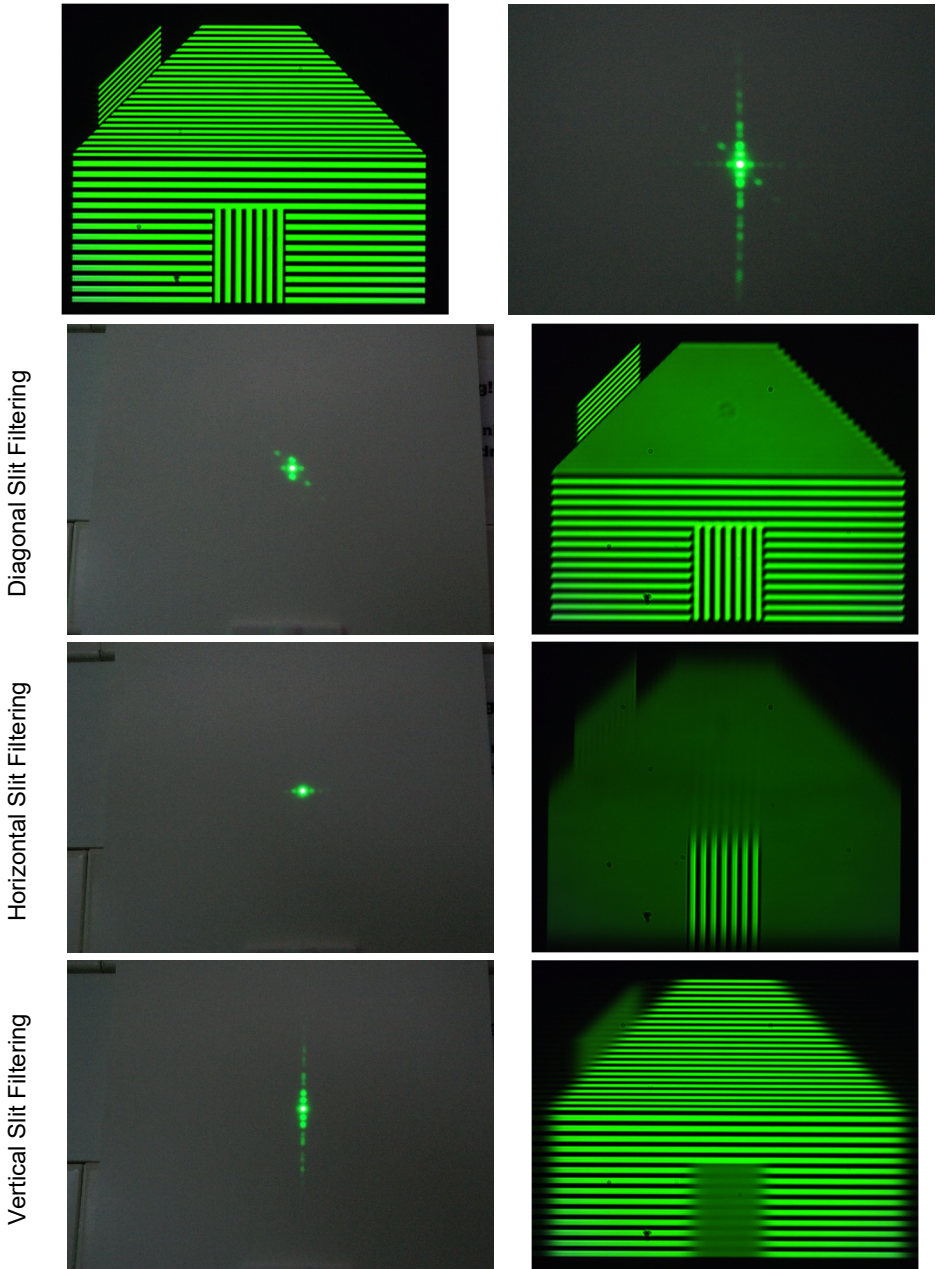
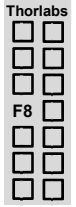

Figure 75: Fourier House Filtering

Exercise 20: Position the line lattice (15 μm lattice constant, field F8 in Figure 31) in the object plane. Replace the variable slit assembly with the EDU-TGC1 mask for cutting [in the second XYF1(/M), see Figure 25 and Figure 32]. Use mask no. 1 on the mask target and filter out every other maximum in the Fourier plane. What do you expect to see on the camera and why?



Execution: Holding a piece of paper onto the surface of the mask helps in finding the Fourier plane. By blocking the maxima of the odd (first, third, fifth, etc.) orders, information about the lattice constant of the line lattice is lost. Only information about a line lattice with double the distance between the intensity maxima reaches the camera. This cuts the lattice constant in half.

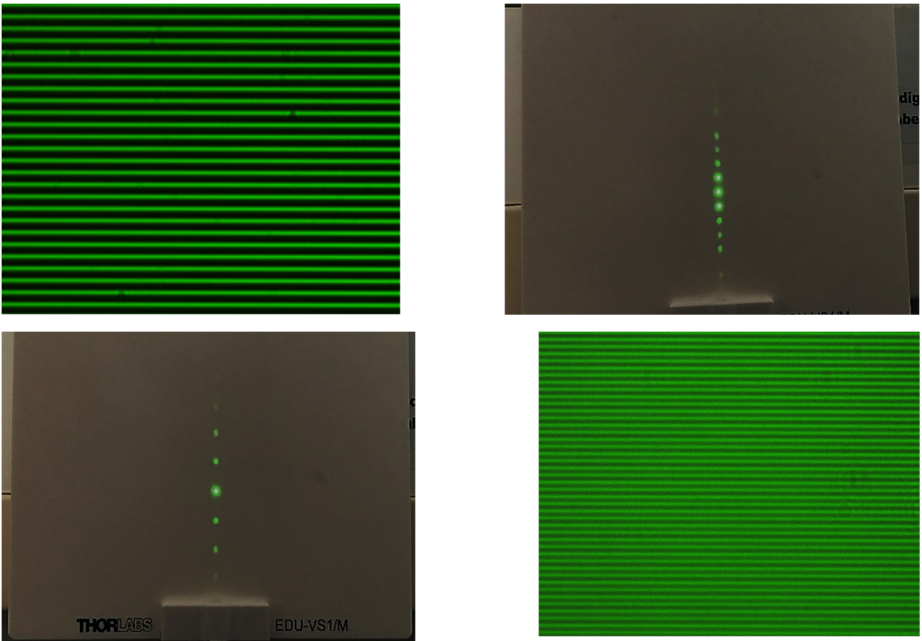
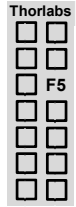

Figure 76: Line Lattice Filtering

Exercise 21: Position the triangles in the object plane, field F5 in Figure 31. Adjust mask no. 2 in the Fourier plane so that every second maximum in all three straight lines of the diffraction maxima is masked. What do you expect to see on the camera?



Execution: Information about the lattice constant is blocked similar to the procedure in the previous exercise. In this special case, it is information about lattice constants in three orientations that forms the sides of the triangles. Ultimately the camera receives information about three line lattices with twice the distance between the intensity maxima. This shrinks the triangles. Each original triangle turns into four smaller triangles. Figure 77 clearly shows the quartering of the triangles by doubling the lattice constant.

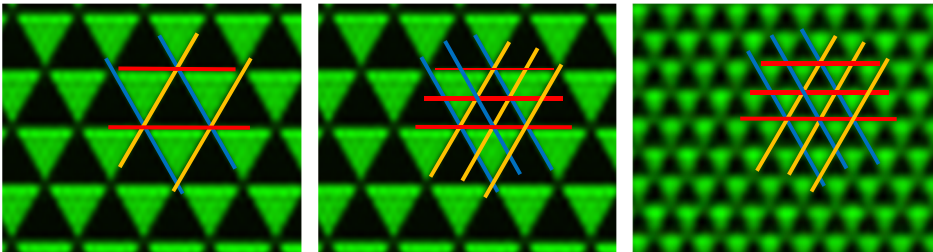

Figure 77: Effect of Lattice Constant Halving on the Triangle Lattice

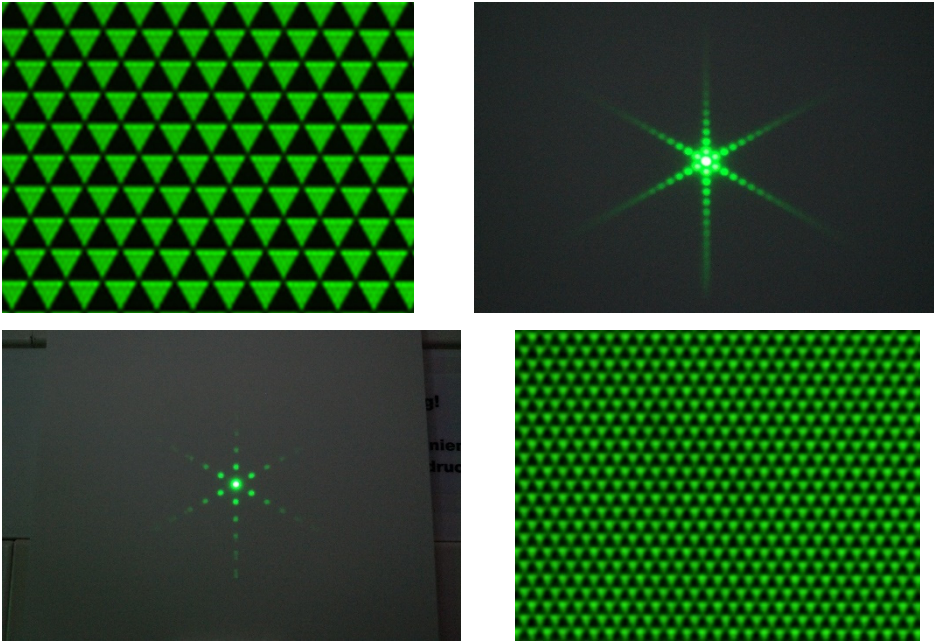
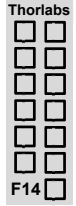

Figure 78: Triangle Filtering (Only One Quarter of the Camera Image Shown)

Exercise 22: Position the sector star in the object plane (field F14 in Figure 31) and the ID12(/M) iris in the Fourier plane. What do you expect to see on the screen when you slowly close the iris? Why?



Execution: Every light-dark pass of the sector star can be considered a tapering single slit. The different orientations create the Fourier image of the sector star. When the ID12(/M) iris in the Fourier plane is closed, information that is far out in the Fourier image is blocked first. These high spatial frequencies can be assigned to the narrowest sections of the single slit. That means the sector star loses the structure from the inside to the outside. Note: In literature, this structure is often referred to as Siemens star.

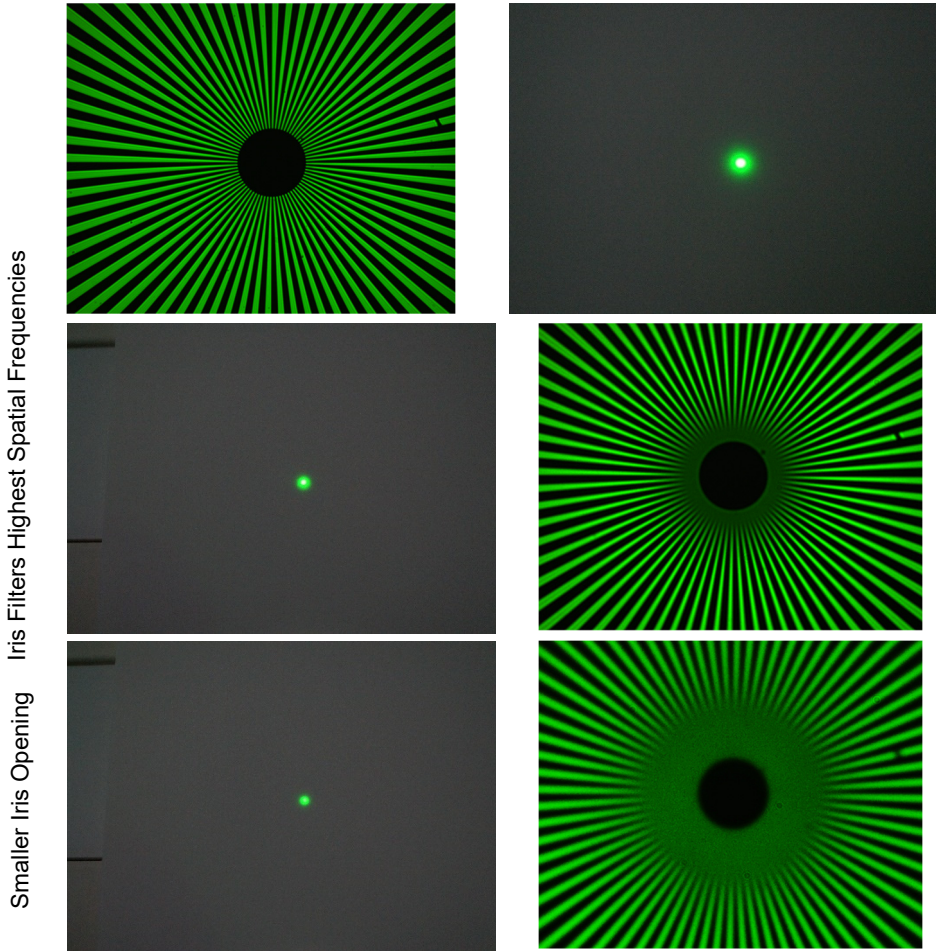

Figure 79: Sector Star Filtering with Iris

Exercise 23: Use the variable slit instead of the iris. What do you expect to happen to the sector star's image when the slit is closed?



Execution: By closing the slit, the Fourier components in one direction are clipped. This, in turn, results in the loss of information for the narrowest sections near the pin hole. In contrast to the previous exercise, this only happens in one direction, while the image information stays intact in the other direction.

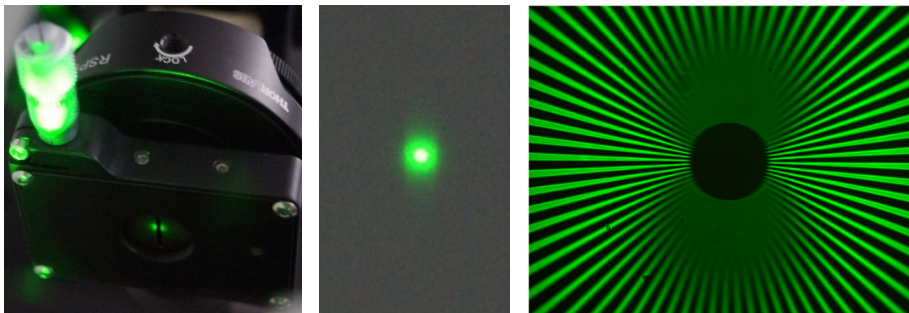

Figure 80: Sector Star Filtering with Slit

6.4. Babinet's Principle

Exercise 24: Observe the image for the Babinet field, field F13 in Figure 31. Now block the zeroth order of light in the Fourier plane with one of the spots on the mask. What happens and why?

Execution: Babinet's Principle states that, apart from the zeroth order, diffraction patterns of complementary structures are identical. In the field labelled "Babinet", two complementary gratings were structured in alteration (column-wise). When the zeroth order is taken from the Fourier plane by blocking it with one of the dots on the mask, the resulting image on the camera shows exactly what Babinet's Principle predicts: regardless of the column, each horizontal line in the image is the same color as the one next to it as opposed to alternating between black and green in the original image. Thus, you cannot distinguish between the complementary gratings.

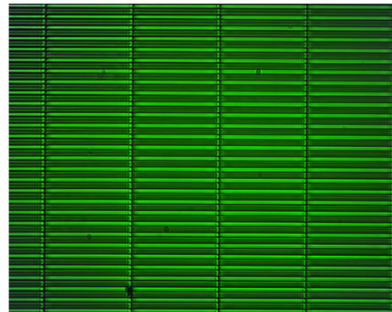
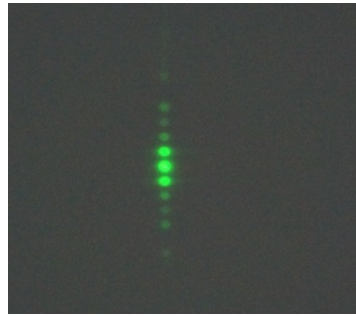
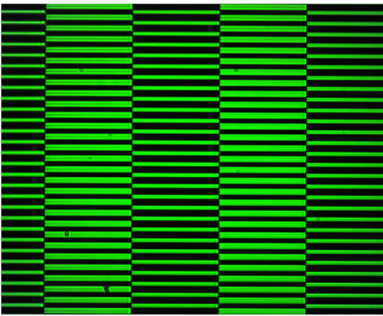
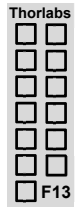
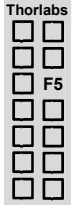

Figure 81: Babinet's Principle Demonstrated with Complementary Gratings

Exercise 25: Similar to the previous exercise, filter the zeroth order for the grating of triangles, field F5 in Figure 31, with a spot of suitable size. What do you expect?



Execution: The special feature here (compared to the previous exercise) is that both structures (bright and dark) have the same dimensions. When the zeroth order is blocked with one of the dots on the mask, both structures are identical and cannot be distinguished. Please note:

- (i) Only a quarter of the camera image is shown in Figure 82.
- (ii) To increase visibility for the filtered image, the gain in the software was increased.

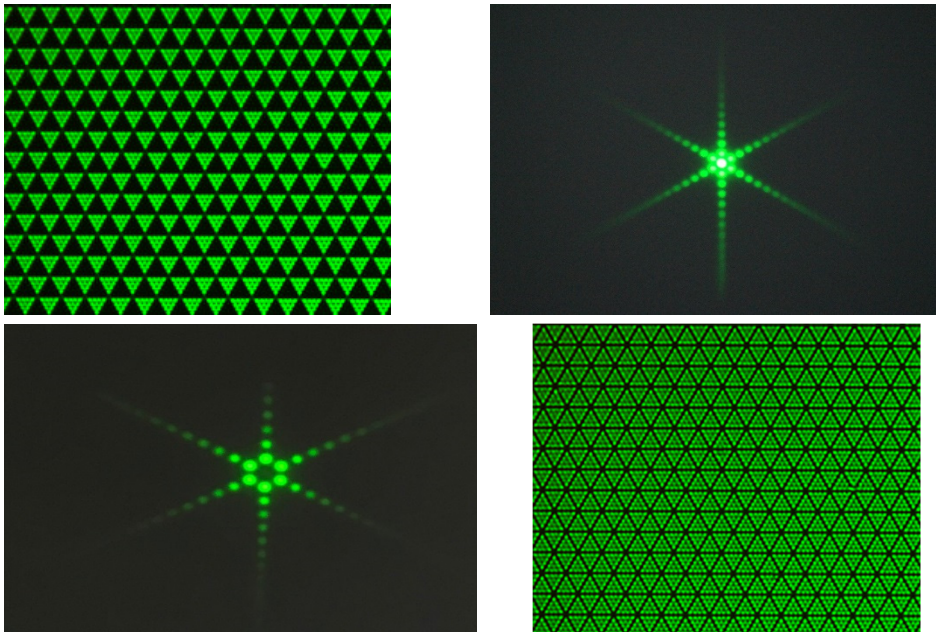

Figure 82: Babinet's Principle Demonstrated with the Symmetric Triangle Grating

Again, note that the zeroth order does not carry structural information. While the brightness is altered, the structure of the image is the same both with and without the zeroth order.

6.5. Image Editing

Exercise 26: Select a character on the target and position it in the object plane. First soft-focus the image with the ID12(/M) iris. Fully close the aperture iris.

Execution: By closing the ID12(/M) iris in the Fourier plane, high spatial frequencies that represent fine structures in the image are masked. The low spatial frequencies that represent coarse structures in the image predominate. The image is soft-focused.

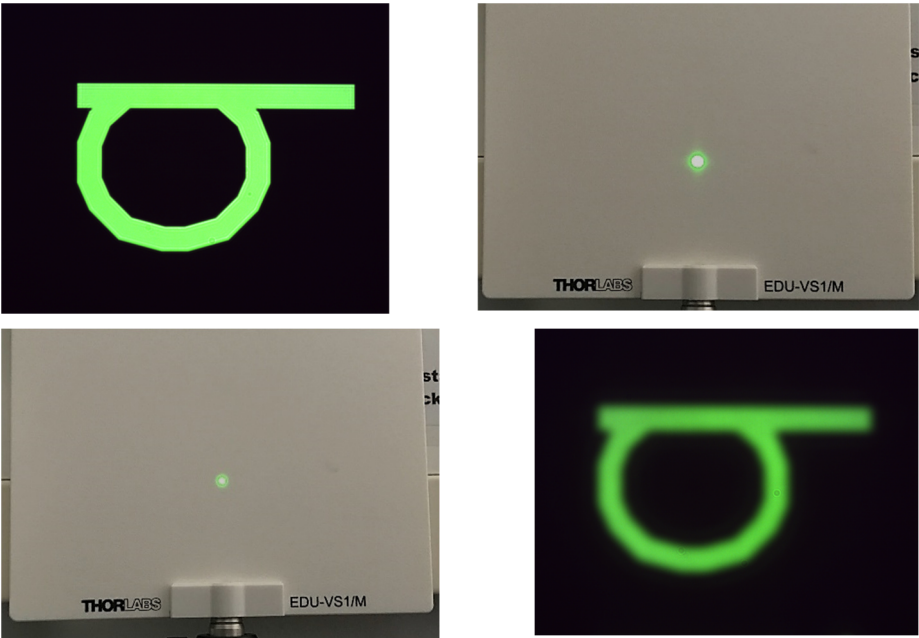

Figure 83: Soft-Focusing Through an Optical Low Pass Filter

Exercise 27: Use the same character as in the previous exercise and highlight the edges.

Execution: The edges of an image can be highlighted by blocking the central spot. The size of the central spot will vary depending on the adjustment of your system. Therefore, you will need to test a few spots on the mask to find one that blocks enough light to achieve the result shown in Figure 84.

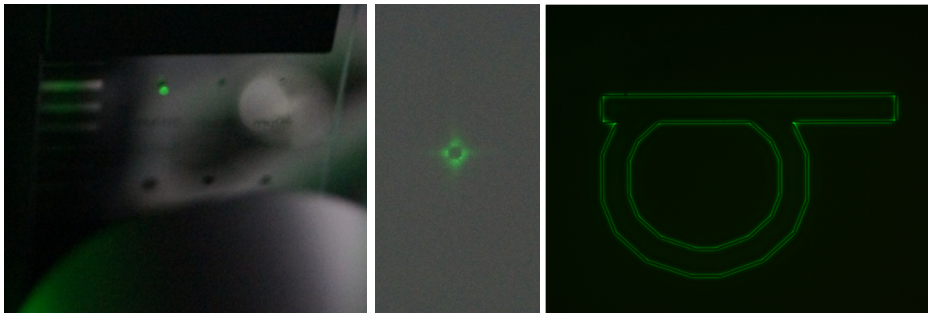

Figure 84: Edge Highlighting

Exercise 28: Now position the diatom slide in the object plane. Bring out the edges of the diatoms in the microscope/camera image by bringing the points on the mask target into the Fourier plane and blocking the central maximum there. Slightly open the aperture iris and regulate the brightness with the LED controller.

Execution: You may have to readjust the aperture iris multiple times to obtain a good result. A lot of patience is required since this effect is easy to miss. A spot on the mask target blocks the low spatial frequencies that represent the coarse structures in the image. The larger the blocking spot in the Fourier plane, the easier it is to see the effect. Make sure you do not mask the Fourier plane entirely. If this is the case, you can rectify it by slightly opening the aperture iris. The high spatial frequencies that represent the fine structures in the image predominate. The image appears sharper overall. Fine structures are more easily discernible. Transparent specimens are very well suited for this.

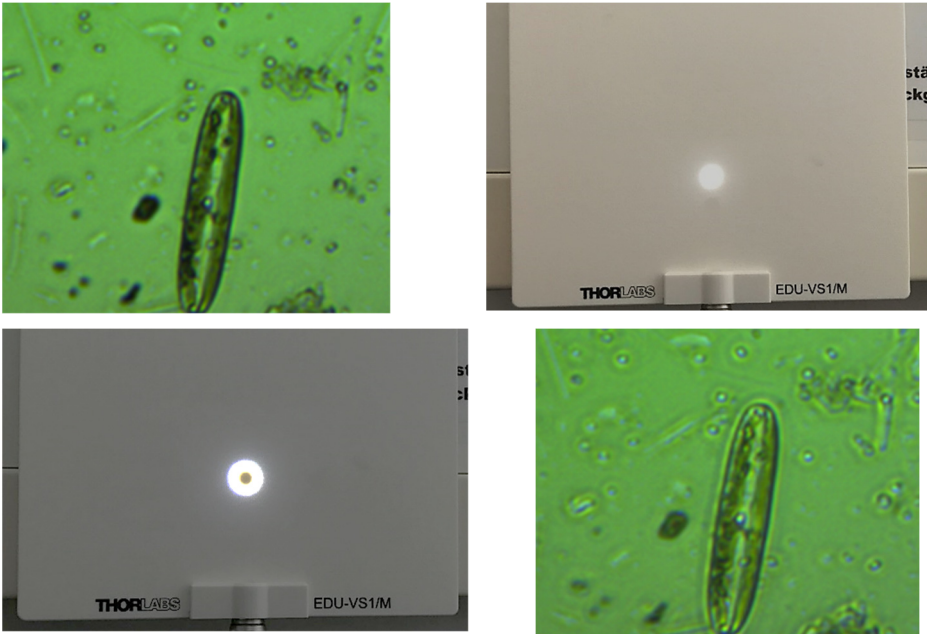

Figure 85: Bringing Out Edges and Increasing Contrast with an Optical High Pass Filter

6.6. Inverse Fourier Target

Exercise 29: Place the inverse Fourier target in the object plane (mounted in the FP01 plate holder). Observe the Fourier plane.

Execution: The inverse Fourier target (also known as a DOE, diffractive optical element) has a microstructured surface that is designed to diffract light in such a manner that the far-field diffraction pattern (and, thus, the Fourier plane) shows an image. In the case of the supplied target, a constellation and the earth can be clearly seen in the Fourier plane. The earth is encoded in the long, structured part on the inverse Fourier target. Depending on the light spot's position, the earth will show at a different angle.

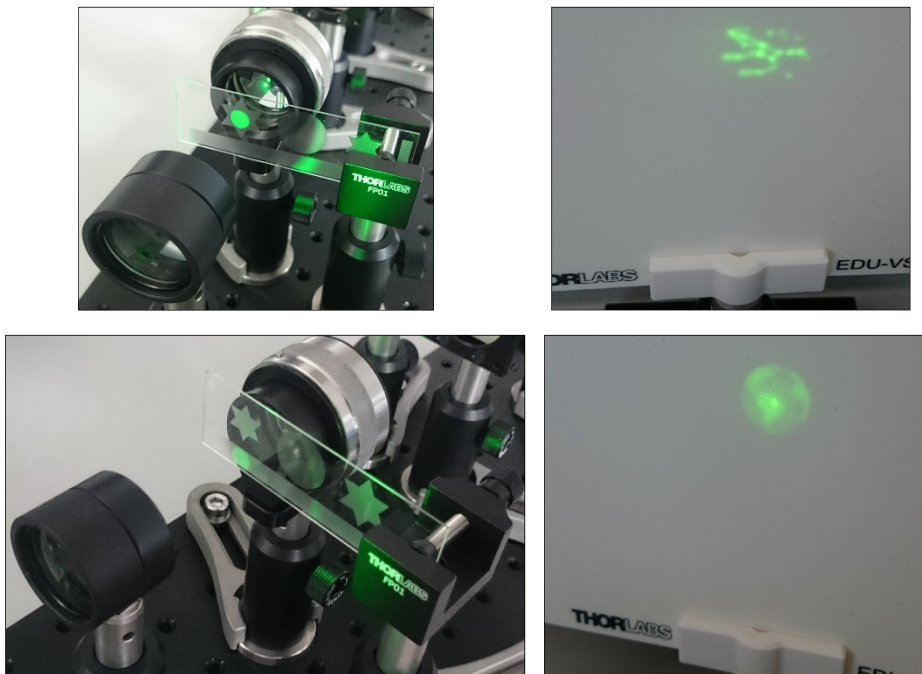

Figure 86: Inverse Fourier Targets in the Object Plane and the Resulting Fourier Plane Images

Exercise 30: Take an image of the constellation's microstructure and try to reproduce the diffraction pattern.

Execution: In order to get a sharp image of the microstructure, move the target with the screws of the xy filter holder until you reach the edge of the structured region. Adjust the objective lens until you see a sharp image of the edge. Then, move the target back to the center of the structured area. Save the image using the camera software and import it into Gwyddion. Use "Correct Data => 2D FFT". You will not be able to get a good image but you should be able to see some characteristics of the constellation.

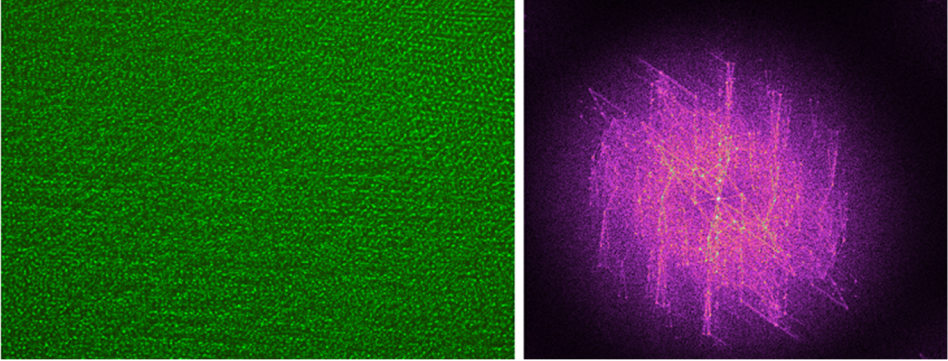

Figure 87: Camera Image of the Inverse Fourier Target (Left) and the Result of the Transformation with Gwyddion (Right)

6.7. Diffraction-Limited Resolution

Exercise 31: Demonstrate that imaging is only possible when at least the first diffraction orders still pass through the imaging lens.

Execution: First, remove all optical elements after the target from the setup (objective lens, beamsplitter, tube lens, and camera).



Figure 88 The first diffraction order does not fall on the lens.

- (1) Adjust the target so you illuminate the smallest lattice, field F1 in Figure 31. Please note that the structures are so small that you will rarely see a sharp image of a rectangle. Instead, you will most often see black spots with rounded edges.
- (2) Close the field iris to about 1/3. Now position the lens previously designated as the tube lens in the beam path so that the diffraction orders lie on the edge of the lens holder. See the image to the right.
- (3) Switch to the next largest lattice (field F2 in Figure 31) so that the first diffraction orders pass through the lens.
- (4) Now use the camera to find the plane that produces a sharp image of the lattice. You may have to push the camera off the breadboard and set it onto a raised support. To find a sharp image, it can help to use a larger structure such as the houses (field F10 in Figure 31, with camera exposure time set to “auto”).

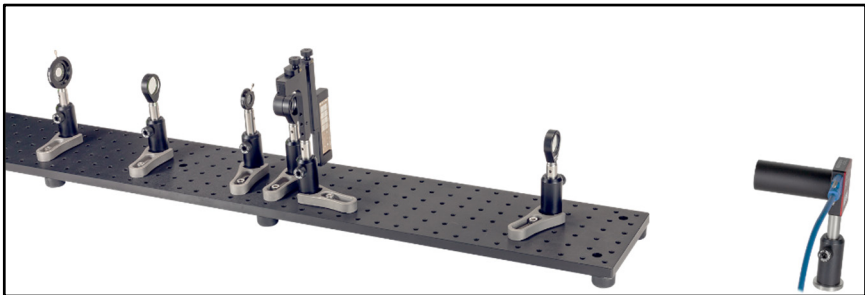

Figure 89: Modified Setup to Show the Diffraction-Limited Resolution

- (5) The resulting image on the camera should look approximately like the image to the right. You may need to adjust the LED brightness or the exposure time to obtain a proper image.
- (6) Now switch back to the smallest lattice. The first orders pass by the lens – and no structure is discernible on the camera any more. This is the basis of Abbe's diffraction limit: only when the setup permits the first orders to pass can an image be generated. If the objects are so small that light is diffracted beyond the edges of the lens, it is no longer possible to generate an image with classic microscopy – see section 4.5.

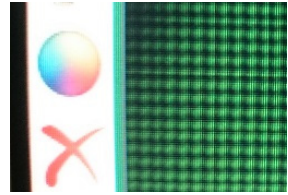

Figure 90 Camera Image

Chapter 7 Condensed Setup Instructions

1. Set all components to a height of 10 cm using the LMR1AP alignment plate (measured from the center of the optical element to the breadboard).
2. Place the camera at the right end of the breadboard (4th hole line) and place the tube lens ($f = 150$ mm) approximately 150 mm from the camera chip. Get a sharp camera image of an object that is more than 4 meters away.
3. Aim the LED at a wall or the ceiling and use the variable lens tube to position the collector lens so that you can see the LED chip (a pattern of black spots). Place the LED 100 cm away from the camera (post-to-post distance).
4. Place the objective lens ($f = 30$ mm) 18 to 20 cm away from the tube lens, measured from the center of the lenses.
5. Move the target up to the highest possible position by turning the height adjustment screw clockwise. Adjust the post's height so that the sector star (lowest row on the target, field F14 in Figure 31) has the same height as your optical axis (10 cm). Place the target approximately 2 cm away from the objective lens mount. Move the target until you obtain a sharp image of the sector star in the camera (fine adjustment may be done by rotating the objective lens' mount). Move the target downward until you see the center house of the arrangement of nine houses, field F10 in Figure 31.
6. Place the condenser lens ($f = 50$ mm) 50 mm away from the target (measured approx. from the center of the lens). Place the condenser lens to achieve the smallest spot size on the target. Make sure the center house is illuminated (otherwise change condenser lens height).
7. Place the closed aperture iris [the smaller one, ID12/(M)] approximately 50 mm away from the condenser lens. The iris' shadow should be centered on the condenser lens mount.
8. Place the field lens ($f = 150$ mm) approximately 150 mm away from the aperture iris. Move the field lens until you see the LED chip on the iris.
9. Place the almost fully closed field iris at approximately 150 mm distance to the field lens. Move back and forth until you see an image of the iris' edge on the camera (hard to see, mainly just a deviation from the round shape).
10. Place the color filter directly in front of the LED
11. Open the field iris (about 3/4). Place the beamsplitter approximately 8 cm away from the objective lens.
12. Position the projection lens ($f = 75$ mm) directly behind the beam splitter (at 90° with respect to the main beam path). Use the screen to find the distance where you see a sharp image of the Fourier plane.
13. Observe the aperture iris' side that's facing the target. When the target is not perpendicular to the beam, you will get reflections that are off-center.

Chapter 8 Troubleshooting

- **The PC does not recognize the camera.**
Unplug the camera from the PC and test different USB ports. Wait until the device is recognized by the PC.
- **No camera image is visible.**
Select a structure and make sure you do not close the field iris completely. Furthermore, the beamsplitter should be positioned so its holder is not illuminated. If this does not eliminate the problem, it may be that the condenser lens is illuminating a different spot on the target than what is displayed on the camera by the combination of the objective lens and tube lens. Remove the field lens from the setup and adjust the condenser lens so that the camera displays an image.
- **The camera image is distorted.**
Distortion of the camera image usually indicates that a lens is not in linear alignment with the other lenses. In most cases, this is the objective lens or tube lens. Always ensure the setup is aligned along a single optic axis. Otherwise the target may also be out of alignment. Examine the reflection of the target on the side of the aperture iris facing the target. Turn the target so that the reflection lies in the opening of the iris as exactly as possible.
- **The camera image cannot be sharpened.**
Check the alignment of the target in the objective lens.
- **Interfering reflections are visible in the Fourier image.**
The aperture diaphragm may be sitting too high and should be adjusted. Without the field lens, the condenser lens and its holder should be evenly covered by the iris' shadow. Check that the target is perpendicular to the optical axis.
- **Intensity maxima that do not match the chosen structure are visible in the Fourier image.**
Make sure that the illuminated section of the target covers only one field of the target. If the illuminated area is larger than a field of the target, the size of the illuminated area can be corrected by adjusting the field iris.
- **The light spot on the target is not round.**
The field diaphragm or the field lens is in the wrong position. Try to adjust the height of the field diaphragm and the field lens.
- **The Fourier plane is too close to the objective lens.**
Make sure you have chosen the right orientation of the lens in the mount and of the mount itself.
- **The camera image flickers in various colors.**
Open the camera settings and, on the "Image" tab, uncheck "Auto White Balance". Then set the controls for red, green, and blue back to 0.

Chapter 9 Ideas for Additional Experiments

In the following section, you will find additional experiments relating to Fourier optics. The components of this kit can, of course, be used for experiments beyond Fourier optics as well, some of which are detailed below.

9.1. Fourier Optics and Coherence

In this experimental kit, the fundamental principle is that the microscope image is the interference effect of the light diffracted by the sample. In other words: light is diffracted by the sample, and this diffracted light (e.g., the diffraction orders from a lattice) interferes in the plane of the camera to form an image. This can be demonstrated by manipulating the prerequisite for interference, namely coherence.

In addition to the exercises discussed in the manual, you can show what happens when the light in the Fourier plane is not coherent. In this case, the microscope image vanishes because the aforementioned interference depends on sufficient coherence. To demonstrate that, we proceed as follows.

Replace the aperture iris in front of the condenser lens ($f = 50\text{ mm}$) with a horizontal slit, for example the S200RD with a width of $b = 200\ \mu\text{m}$, as shown in Figure 91.



Figure 91: S200RD replaces the aperture iris in front of the condenser lens.

Next, choose the line grating on the target, field F8 in Figure 31. Then, the Fourier plane should show the diffraction pattern in Figure 92. It consists of horizontal lines since we now have a slit in front of the condenser lens.

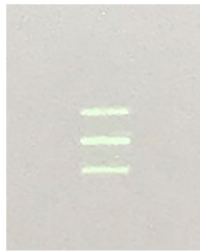

Figure 92: Diffraction Pattern in the Fourier Plane, Photographed on the Screen

In the next step, position the variable and rotatable slit in the Fourier plane and almost close it. At this point, it may be necessary to increase the gain in the second tab of the camera settings, depending on the slit width. Alternatively, you may increase the integration time in the first tab of the camera settings.

Now slowly rotate the slit until you obtain a pattern similarly to the one on the right side of Figure 93.

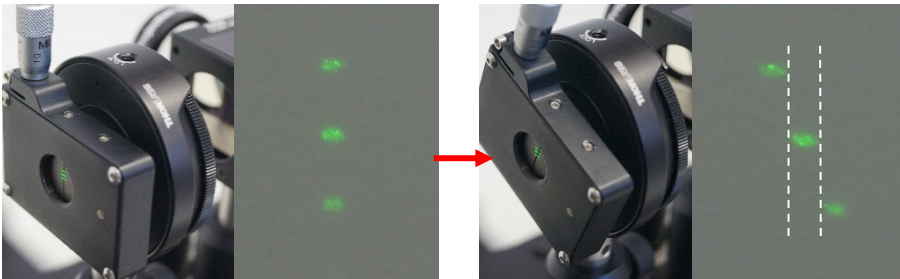

Figure 93: Variable and Rotatable Slit in the Fourier Plane with Corresponding Pattern on the Screen

When the variable slit is rotated far enough that the maxima do not show overlap in the vertical (see Figure 93, right) then one might naively expect the camera image to show a rotated lattice, similarly to Figure 65. Instead, the line grating shown on the left of Figure 94 has vanished. This stems from the missing coherence of the chosen maxima:

- The different light spots/maxima in the Fourier plane are created by the diffraction of light from different sections of the light source, which in this case, is effectively the slit.
- In general, there is no statistical correlation between the emission times of different points on the light source. This automatically means that the phase relation between two points on the light source changes continuously.

- Since we only see one maximum for each area (left, center, and right), the diffraction orders cannot interfere with each other. Consequently, there can be no stationary image on the camera, i.e., no interference.

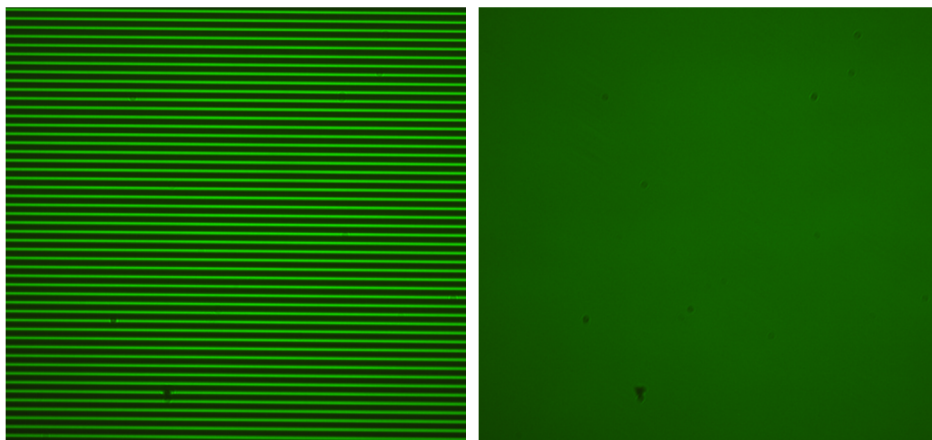

Figure 94: Camera image for a vertical (left) and rotated (right) slit. The angle of rotation corresponds to the right side of Figure 93.

This experiment is proof of the statement that the diffracted light of the sample, e.g., the diffraction orders of a grating, have to interfere in order to form the camera image.

9.2. Quantitative Measurement

When you wish to work quantitatively with the kit, consider the following experiment. As already discussed, the image in the camera plane forms as an interference of the various diffraction orders. In other words, the image is pieced together by the diffraction order. The more orders are available (i.e., fall onto the lens), the better the object plane is reproduced in the camera plane.

This can be measured quantitatively on the camera. If one could map the ideal grating, the intensity distribution would be a rectangular function. In reality, the quality of the image of the grating reproduced in the camera plane is limited by the number of contributing orders.

This principle is depicted in Figure 95 with a symmetric rectangular function. Each oscillation represents a maximum in the Fourier plane with the corresponding frequency. The sum of the different oscillations (which corresponds to the Fourier series) resembles the rectangular function better the more oscillations contribute to it. The higher the order of the oscillations, the higher their (spatial) frequency.

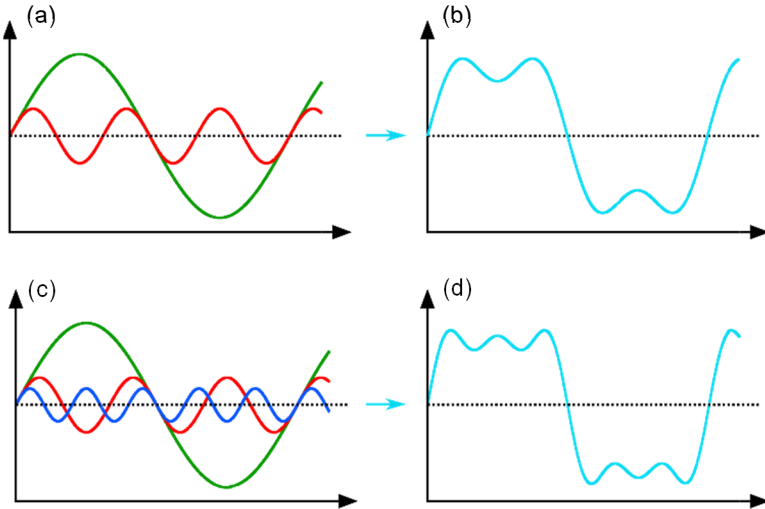

Figure 95: Representation of the Fourier series for a symmetric rectangular function. (a) shows the first and the third harmonic (the second one is zero due to the function's symmetry), (b) shows the sum of (a), (c) depicts the first, third and fifth harmonic, and (d) shows the sum of (c).

In principle, this behavior can be measured although it requires a very well-adjusted setup. You will not be able to measure the contribution of each individual oscillation/diffraction order, though, since we need a large enough structure on the camera to reasonably measure. Note that the larger the structure is, the closer the diffraction orders lie in the Fourier plane. Therefore, it makes sense to use the grating with a 50 μm lattice constant and 20 μm spacing, field F4 in Figure 31. It is the largest structure available and it still allows adjacent diffraction orders to be distinguished.



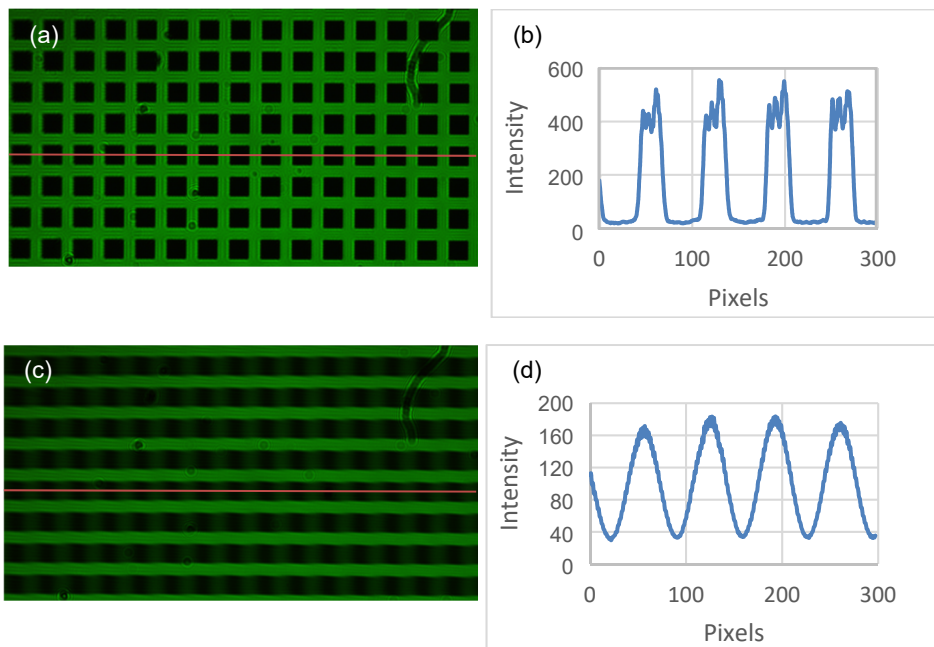

Figure 96: (a) shows the camera image of the “ $g = 50 \mu\text{m}$, $b = 20 \mu\text{m}$ ” grating where all diffraction orders were used for the image generation, (b) shows a cut through the image from (a). (c) shows the camera image when only the 0^{th} and 1^{st} diffraction order are allowed to pass to the camera; all other orders are blocked by the variable slit. (d) shows a cut through the image in (c). The result is a harmonic oscillation.

Figure 96 shows the results with this grating. It becomes apparent that the “sharp” camera image (with all diffraction orders) is just an approximation to the ideal lattice since, in practice, not only the number of contributing diffraction orders plays a role, but also the “normal” aberrations in a microscope. When all orders but the 0^{th} and 1^{st} are removed, a harmonic oscillation is observed that can be compared to theory. When you want to investigate this effect in detail and want to measure the impact of orders higher than the 1^{st} , then you might want to improve the magnification of the microscope. You can do that by changing the tube lens to a 300 mm focal length lens (instead of the 150 mm lens used here) or larger. With optimal adjustment, the breadboard will be long enough for a 300 mm lens but not for lenses with longer focal lengths.

9.3. Measuring the Diffraction Pattern of a Single Slit

The variable slit is set up for this purpose instead of the target. All optical components behind it can be removed. Now the camera has to be positioned at a distance to the slit so that significant parts of the single slit diffraction pattern lie on the camera chip. Then the image can be sectioned and the intensity profile can be read using the ThorCam software.

9.4. Spectrometer

When the green filter is removed from the LED and an optical lattice with a small lattice spacing is used as the target, the setup can be converted into a simple spectrometer. To do so, remove all optical components behind the lattice and displace the camera so that an entire colored maximum lies on the camera. In addition, the aperture diaphragm should be replaced with a variable slit. When a light source other than the LED is then used, one can analyze the spectrum of the other light source by comparing it with the LED spectrum.

9.5. Slide Projector

With a suitable selection of lenses, the lattice can be projected onto a wall behind the setup. To do so, place the lattice in front of the LED and remove all other optical components. Now the lattice can be displayed on the wall with two carefully positioned lenses.

9.6. Darkfield Microscopy

With the microscope in this kit, it is also possible to perform darkfield microscopy. The image produced by this microscopy method is distinguished by a dark background with illuminated sample details. It is necessary that all undiffracted background light is blocked in the Fourier plane. To do so, remove the target from the object plane between condenser and objective lens and block all light in the Fourier plane behind the objective lens with a spot from the mask target. It is advisable to use one of the largest spots on the mask target and open the aperture diaphragm until the spot is fully illuminated. To check the illumination, look at the screen behind the projection lens. Position the diatom sample in the object plane between condenser and objective lens so that you get a sharp image on the camera. The camera image shows illuminated diatoms on a dark background like in Figure 97. Undiffracted light (background light) is blocked by the spot while diffracted light from the diatoms (object light) passes the Fourier plane.

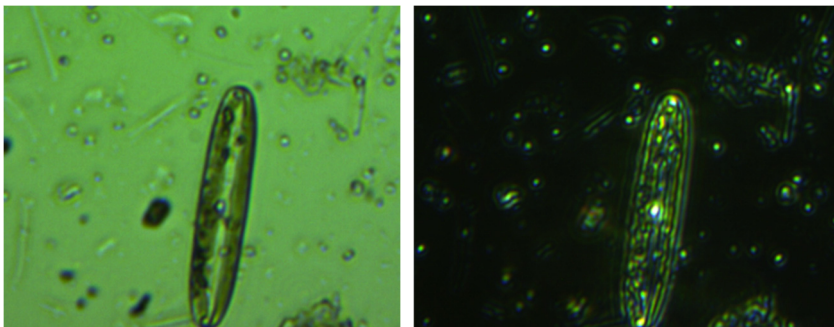

Figure 97: Diatom sample shown with brightfield microscopy on the left and darkfield microscopy on the right.

Generally, darkfield microscopy is performed with a ring aperture in front of the condenser lens and a ring mask in the Fourier plane. The dimensions of the necessary ring aperture and ring mask for the Fourier setup are shown in Figure 98. We tested the ring aperture and ring mask printed on a photographic slide, but the results were not as good as the results using the ID12(M) iris and a spot from the mask target. This was mainly due to the low printing quality of the black areas on the slide with the ring aperture and mask.

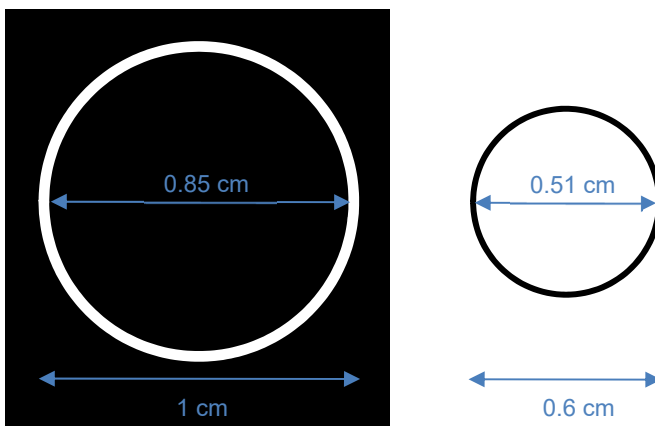

Figure 98: Dimensions of the ring aperture and the ring mask.

Have you performed other experiments with the parts in this kit? Let us know by contacting techsupport@thorlabs.com and we'll add them to the manual!

Chapter 10 Matlab Code

This is the Matlab code used to generate the numerical results in Section 4.1.8. We compute the Fourier transform of a given image. To show the contribution of phase and amplitude, we back-transform and plot (i) the amplitude alone and (ii) the phase along with a random amplitude. As shown in Section 4.1.8, most of the information lies in the phase.

```
clear all;
close all;

% Load image
imdata = imread('Tiger.jpg');
figure(); imshow(imdata); title('Original')

% Transform image from color to greyscale
imdata = rgb2gray(imdata);

% Fourier transform Image and shift pattern so origin is in the center
F = fft2(imdata);
F_shifted = fftshift(F);

% Extract phase and amplitude, F = Amplitude.*exp(1i*Phase)
Amplitude = abs(F_shifted);
Phase = angle(F_shifted);
figure(); imshow(log(Amplitude),[]); title('Fourier Trafo: log(Amplitude)');
figure(); imshow(Phase,[]); title('Fourier Trafo: Phase');

% Transform back: only amplitude, no phase
ONLY_AMPL = Amplitude;
Manual_F_backshift = ifftshift(ONLY_AMPL);
Manual_F_back = ifft2(Manual_F_backshift);
figure(); imshow(log(Manual_F_back),[]); title('Only Amplitude transformed
back, log-Plot')

% Transform back: amplitude is random, include phase
Dimension = size(F);
Noise = rand(Dimension(1),Dimension(2));
figure(); imshow(Noise,[]); title('Noise')
PHASEwithNOISE = Noise.*exp(1i.*Phase);
PHASEwithNOISE_backshift = ifftshift(PHASEwithNOISE);
PHASEwithNOISE_back = ifft2(PHASEwithNOISE_backshift);
figure(); imshow(PHASEwithNOISE_back,[]); title('Random Amplitude with Phase
transformed back')
```

Chapter 11 Acknowledgements

We would like to thank Kurt Thorn, formerly a Professor at the University of California, San Francisco, for his collaboration in the development of this kit. The prototype of the setup was published in his blog: <https://nic.ucsf.edu/blog/>

We cordially thank Anna Burvall from the KTH Royal Institute of Technology, Sweden, for sharing the idea for the Babinet field.

We would also like to thank Prof. Wilfried Sommer, head of the Institute for Subject-Related Methodology, for the Fourier house materials. The Institute for Subject-Related Methodology in Kassel is closely affiliated to Alanus University and has a strong link to the division for teaching materials of the Bildungswerk Beruf und Umwelt: <http://www.lehrerseminar-forschung.de/shop/geraete/physik.html?klasse=3>

We thank the team of the undergraduate lab of the Freie Universität Berlin for their idea for the quantitative measurements in Chapter 9.

Do you also have ideas for an experiment which you either have implemented already or want to implement? Please contact us at techsupport@thorlabs.com. We are happy to enter into partnerships!

Chapter 12 Regulatory

As required by the WEEE (Waste Electrical and Electronic Equipment Directive) of the European Community and the corresponding national laws, Thorlabs offers all end users in the EC the possibility to return “end of life” units without incurring disposal charges.

- This offer is valid for Thorlabs electrical and electronic equipment:
- Sold after August 13, 2005
- Marked correspondingly with the crossed out “wheelie bin” logo (see right)
- Sold to a company or institute within the EC
- Currently owned by a company or institute within the EC
- Still complete, not disassembled and not contaminated



Wheelie Bin Logo

As the WEEE directive applies to self-contained operational electrical and electronic products, this end of life take back service does not refer to other Thorlabs products, such as:

- Pure OEM products, that means assemblies to be built into a unit by the user (e.g. OEM laser driver cards)
- Components
- Mechanics and optics
- Left over parts of units disassembled by the user (PCB's, housings etc.).

If you wish to return a Thorlabs unit for waste recovery, please contact Thorlabs or your nearest dealer for further information.

Waste Treatment is Your Own Responsibility

If you do not return an “end of life” unit to Thorlabs, you must hand it to a company specialized in waste recovery. Do not dispose of the unit in a litter bin or at a public waste disposal site.

Ecological Background

It is well known that WEEE pollutes the environment by releasing toxic products during decomposition. The aim of the European RoHS directive is to reduce the content of toxic substances in electronic products in the future.

The intent of the WEEE directive is to enforce the recycling of WEEE. A controlled recycling of end of life products will thereby avoid negative impacts on the environment.

Chapter 13 Thorlabs Worldwide Contacts

For technical support or sales inquiries, please visit us at www.thorlabs.com/contact for our most up-to-date contact information.



USA, Canada, and South America

Thorlabs, Inc.
sales@thorlabs.com
techsupport@thorlabs.com

Europe

Thorlabs GmbH
europe@thorlabs.com

France

Thorlabs SAS
sales.fr@thorlabs.com

Japan

Thorlabs Japan, Inc.
sales@thorlabs.jp

UK and Ireland

Thorlabs Ltd.
sales.uk@thorlabs.com
techsupport.uk@thorlabs.com

Scandinavia

Thorlabs Sweden AB
scandinavia@thorlabs.com

Brazil

Thorlabs Vendas de Fotônicos Ltda.
brasil@thorlabs.com

China

Thorlabs China
chinasales@thorlabs.com



THORLABS
www.thorlabs.com
