

AutoCAD Civil 3D 2011

Tutorials

Autodesk®

April 2010

© 2010 Autodesk, Inc. All Rights Reserved. Except as otherwise permitted by Autodesk, Inc., this publication, or parts thereof, may not be reproduced in any form, by any method, for any purpose.

Certain materials included in this publication are reprinted with the permission of the copyright holder.

Trademarks

The following are registered trademarks or trademarks of Autodesk, Inc., and/or its subsidiaries and/or affiliates in the USA and other countries: 3DEC (design/logo), 3December, 3December.com, 3ds Max, Algor, Alias, Alias (swirl design/logo), AliasStudio, AliasWavefront (design/logo), ATC, AUGI, AutoCAD, AutoCAD Learning Assistance, AutoCAD LT, AutoCAD Simulator, AutoCAD SQL Extension, AutoCAD SQL Interface, Autodesk, Autodesk Envision, Autodesk Intent, Autodesk Inventor, Autodesk Map, Autodesk MapGuide, Autodesk Streamline, AutoLISP, AutoSnap, AutoSketch, AutoTrack, Backburner, Backdraft, Built with ObjectARX (logo), Burn, Buzzsaw, CAiCE, Civil 3D, Cleaner, Cleaner Central, ClearScale, Colour Warper, Combustion, Communication Specification, Constructware, Content Explorer, Dancing Baby (image), DesignCenter, Design Doctor, Designer's Toolkit, DesignKids, DesignProf, DesignServer, DesignStudio, Design Web Format, Discreet, DWF, DWG, DWG (logo), DWG Extreme, DWG TrueConvert, DWG TrueView, DXF, Ecotect, Exposure, Extending the Design Team, Face Robot, FBX, Fempro, Fire, Flame, Flare, Flint, FMDesktop, Freewheel, GDX Driver, Green Building Studio, Heads-up Design, Heidi, HumanIK, IDEA Server, i-drop, ImageModeler, iMOUT, Incinerator, Inferno, Inventor, Inventor LT, Kaydara, Kaydara (design/logo), Kynapse, Kynogon, LandXplorer, Lustre, MatchMover, Maya, Mechanical Desktop, Moldflow, Moonbox, MotionBuilder, Movimento, MPA, MPA (design/logo), Moldflow Plastics Advisers, MPI, Moldflow Plastics Insight, MPX, MPX (design/logo), Moldflow Plastics Xpert, Mudbox, Multi-Master Editing, Navisworks, ObjectARX, ObjectDBX, Open Reality, Opticore, Opticore Opus, Pipeplus, PolarSnap, PortfolioWall, Powered with Autodesk Technology, Productstream, ProjectPoint, ProMaterials, RasterDWG, RealDWG, Real-time Roto, Recognize, Render Queue, Retimer, Reveal, Revit, Showcase, ShowMotion, SketchBook, Smoke, Softimage, SoftimageXSI (design/logo), Sparks, SteeringWheels, Stitcher, Stone, StudioTools, ToolClip, Topobase, Toxik, TrustedDWG, ViewCube, Visual, Visual LISP, Volo, Vtour, Wire, Wiretap, WiretapCentral, XSI, and XSI (design/logo).

All other brand names, product names or trademarks belong to their respective holders.

Disclaimer

THIS PUBLICATION AND THE INFORMATION CONTAINED HEREIN IS MADE AVAILABLE BY AUTODESK, INC. "AS IS." AUTODESK, INC. DISCLAIMS ALL WARRANTIES, EITHER EXPRESS OR IMPLIED, INCLUDING BUT NOT LIMITED TO ANY IMPLIED WARRANTIES OF MERCHANTABILITY OR FITNESS FOR A PARTICULAR PURPOSE REGARDING THESE MATERIALS.

Published By: Autodesk, Inc.
111 McInnis Parkway
San Rafael, CA 94903, USA

Contents

Chapter 1	Welcome to the AutoCAD Civil 3D Tutorials	1
	Getting More Information	2
	Setting Up the Workspace	3
	Saving Your Tutorial Drawings	3
Chapter 2	Getting Started Tutorials	5
	Tutorial: Understanding the AutoCAD Civil 3D User Interface	5
	Exercise 1: Finding Tools	6
	Exercise 2: Understanding the Toolspace	9
	Exercise 3: Using the Panorama Window	12
	Tutorial: Using Basic Functionality	15
	Tutorial: Viewing AutoCAD Civil 3D Objects	17
	Exercise 1: Setting Up the Drawing Window	17
	Exercise 2: Changing the Display of an Object	19
	Exercise 3: Viewing a Drawing in Model	21
Chapter 3	Points Tutorials	25
	Tutorial: Creating Point Data	25
	Exercise 1: Creating Description Keys	26
	Exercise 2: Creating Point Groups	27
	Exercise 3: Importing Points from a Database	29
	Tutorial: Displaying and Editing Points	30
	Exercise 1: Displaying an Externally Referenced Drawing	31

	Exercise 2: Changing the Style of a Point Group	32
	Exercise 3: Changing Point Group Display Order	33
	Exercise 4: Removing an Externally Referenced Drawing	35
	Exercise 5: Editing Points	35
	Tutorial: Adding User-Defined Properties to Points	37
	Exercise 1: Creating User-Defined Properties	37
	Exercise 2: Creating a Label Style That Displays a User-Defined Property	39
	Exercise 3: Assigning User-Defined Properties to Points	41
	Exercise 4: Importing Points with User-Defined Properties	42
	Exercise 5: Querying User-Defined Property Information	44
Chapter 4	Point Cloud Tutorials	47
	Tutorial: Working with Point Clouds	47
	Exercise 1: Importing Point Cloud Data	47
	Exercise 2: Working with Point Cloud Styles	50
	Exercise 3: Adding Point Cloud Data to a Surface	53
Chapter 5	Surfaces Tutorials	59
	Tutorial: Creating and Adding Data to a Surface	59
	Exercise 1: Creating a TIN Surface	63
	Exercise 2: Adding Point Data to a Surface	64
	Exercise 3: Adding Breaklines to a Surface	65
	Exercise 4: Adding an Outer Boundary to a Surface	70
	Tutorial: Working with Large Surfaces	73
	Exercise 1: Limiting Imported Surface Data	74
	Exercise 2: Simplifying a Surface	79
	Tutorial: Changing the Surface Style and Display	81
	Exercise 1: Editing the Surface Style	82
	Exercise 2: Using a Different Style for a Surface	83
	Exercise 3: Labeling a Surface	84
	Tutorial: Editing Surface Data	86
	Exercise 1: Swapping TIN Edges	88
	Exercise 2: Deleting TIN Lines	91
	Exercise 3: Adding a Hide Boundary	93
	Exercise 4: Smoothing a Surface	95
	Tutorial: Creating a Watershed and Water Drop Analysis	96
	Exercise 1: Configuring a Style for Watershed Display	97
	Exercise 2: Generating a Watershed Analysis	98
	Exercise 3: Creating a Watershed Legend	99
	Exercise 4: Extracting Objects from a Surface	100
	Exercise 5: Analyzing Surface Water Runoff	101
	Tutorial: Generating Surface Volume Information	105
	Exercise 1: Creating the Base and Comparison Surfaces	106
	Exercise 2: Creating a TIN Volume Surface	109

	Exercise 3: Creating a Composite Volume Calculation	110
	Tutorial: Visualizing Surface Data	111
	Exercise 1: Moving Multi-View Blocks to a Surface	111
	Exercise 2: Rendering a Surface	114
	Tutorial: Obtaining an Aerial Image and Draping It on a Surface	116
	Exercise 1: Publishing Surface Data to Google Earth	117
	Exercise 2: Importing a Google Earth Image	121
	Exercise 3: Draping an Image on a Surface	124
Chapter 6	Survey Tutorials	129
	Tutorial: Survey Setup	129
	Exercise 1: Creating a Survey Database	130
	Exercise 2: Setting the Equipment and Figure Prefix Databases	130
	Exercise 3: Adjusting and Verifying Settings	132
	Exercise 4: Setting Survey Styles	134
	Exercise 5: Setting Up a Linework Code Set	135
	Tutorial: Importing Survey Data	136
	Exercise 1: Importing Field-Coded Survey Data	136
	Exercise 2: Updating Imported Survey Data	139
	Tutorial: Viewing and Editing Survey Data	144
	Exercise 1: Viewing Survey Data	144
	Exercise 2: Editing a Figure	146
	Tutorial: Analyzing and Reducing Survey Data	147
	Exercise 1: Querying Survey Data	148
	Exercise 2: Performing Traverse Analysis	150
	Exercise 3: Performing Least Squares Analysis	152
	Exercise 4: Translating a Survey Database	154
	Tutorial: Manually Creating Survey Data	155
	Exercise 1: Creating Survey Data Using the Toolspace Survey Tab	156
	Exercise 2: Creating Survey Data Using the Traverse Editor	160
	Exercise 3: Creating Survey Data Using the Survey Command Window	164
	Exercise 4: Calculating an Azimuth in The Astronomic Direction Calculator	167
	Exercise 5: Creating Figures from Parcels	170
	Tutorial: Outputting Survey Information	171
	Exercise 1: Viewing Inverse and Mapcheck Information on a Survey Figure	171
	Exercise 2: Performing a Mapcheck Analysis with Parcel Labels	173
	Exercise 3: Performing a Mapcheck Analysis by Manually Entering Data	176
	Exercise 4: Working with Mapcheck Data	179
	Exercise 5: Creating Surface Breaklines from Figures	181

Chapter 7	Project Management Tutorials	183
	Tutorial: Using Data Shortcuts	183
	Exercise 1: Setting Up a Data Shortcut Folder	184
	Exercise 2: Creating Data Shortcuts	186
	Exercise 3: Referencing Data Shortcuts	188
	Tutorial: Vault Setup	195
	Exercise 1: Logging In to Autodesk Vault	195
	Exercise 2: Creating User Accounts and Groups	197
	Exercise 3: Creating a Project	199
	Tutorial: Creating, Referencing, and Modifying Project Object	
	Data	200
	Exercise 1: Adding a Drawing to the Project	201
	Exercise 2: Creating a Reference to a Project Object	202
	Exercise 3: Checking Out and Modifying a Project Object	204
	Exercise 4: Checking In a Project Object	205
	Exercise 5: Updating a Project Object	206
	Tutorial: Creating and Modifying Project Point Data	207
	Exercise 1: Adding Points to a Project	207
	Exercise 2: Checking Out and Modifying Project Points	209
	Exercise 3: Checking In Project Points	210
	Tutorial: Exporting and Importing Vault Projects	211
	Exercise 1: Exporting a Vault Project	211
	Exercise 2: Importing a Data Shortcut Project into Vault	212
Chapter 8	Alignments Tutorials	213
	Tutorial: Creating Alignments	213
	Exercise 1: Creating an Alignment with the Alignment Layout	
	Tools	214
	Exercise 2: Adding Free Curves and Spirals to an	
	Alignment	217
	Exercise 3: Adding Floating Curves to an Alignment	219
	Tutorial: Editing Alignments	223
	Exercise 1: Editing the Layout Parameter Values of an	
	Alignment	223
	Exercise 2: Grip Editing an Alignment	225
	Exercise 3: Applying a Mask to an Alignment	227
	Tutorial: Working with Offset Alignments	232
	Exercise 1: Creating Offset Alignments	233
	Exercise 2: Editing an Offset Alignment	236
	Exercise 3: Adding a Widening to an Offset Alignment	239
	Exercise 4: Editing an Offset Widening	243
	Tutorial: Designing an Alignment that Refers to Local Standards	248
	Exercise 1: Drawing an Alignment that Refers to Design	
	Criteria	248

	Exercise 2: Viewing and Correcting Alignment Design Criteria Violations	253
	Exercise 3: Working with Design Checks	256
	Exercise 4: Modifying a Design Criteria File	259
	Tutorial: Applying Superelevation to an Alignment	262
	Exercise 1: Calculating Superelevation for an Alignment	262
	Exercise 2: Calculating Superelevation for an Individual Curve	264
	Exercise 3: Creating a Superelevation View	267
	Exercise 4: Adding and Modifying Superelevation Stations	269
	Exercise 5: Editing Superelevation Parameters Graphically	272
Chapter 9	Profiles Tutorials	275
	Tutorial: Designing Simple Profiles	275
	Tutorial: Using Surface Profiles	279
	Exercise 1: Creating and Displaying Surface Profiles with Offsets	280
	Exercise 2: Changing the Profile Style	282
	Exercise 3: Reviewing Surface Profile Characteristics	285
	Tutorial: Using Layout Profiles	287
	Exercise 1: Creating a Layout Profile	288
	Exercise 2: Editing a Layout Profile	292
	Exercise 3: Copying a Profile and Offsetting it Vertically	294
	Tutorial: Designing a Profile that Refers to Local Standards	297
	Exercise 1: Specifying Profile Design Criteria	298
	Exercise 2: Drawing a Profile that Refers to Design Criteria	299
	Exercise 3: Viewing and Correcting Profile Design Criteria Violations	301
	Tutorial: Displaying and Modifying Profile Views	304
	Exercise 1: Editing the Profile View Style	305
	Exercise 2: Adding Hatch Patterns Between Profiles	310
	Exercise 3: Projecting Objects onto a Profile View	314
	Exercise 4: Splitting a Profile View	321
	Exercise 5: Creating Multiple Profile Views	324
	Exercise 6: Creating Stacked Profile Views	326
	Tutorial: Working with Data Bands	330
	Exercise 1: Adding Data Bands to a Profile View	331
	Exercise 2: Moving Labels in a Data Band	336
	Exercise 3: Modifying a Data Band Style	339
Chapter 10	Parcels Tutorials	341
	Tutorial: Creating Parcels	341
	Exercise 1: Creating Parcels from AutoCAD Objects	341
	Exercise 2: Subdividing a Parcel with a Free-Form Segment	345
	Exercise 3: Subdividing a Parcel with a Slide Line	348

Exercise 4: Subdividing a Parcel with a Swing Line	355
Exercise 5: Working with Alignments and Parcels	359
Tutorial: Editing Parcel Data	361
Exercise 1: Sliding a Parcel Lot Line	362
Exercise 2: Swinging One End of a Parcel Lot Line	368
Exercise 3: Editing Parcel Lot Line Geometry	375
Tutorial: Displaying and Analyzing Parcels	381
Exercise 1: Changing Parcel Style Display Order	382
Exercise 2: Exporting Parcel Data	385
Chapter 11 Grading Tutorials	387
Tutorial: Setting up Grading Standards	387
Exercise 1: Reviewing Grading Settings	388
Exercise 2: Creating Grading Criteria	388
Exercise 3: Creating Grading Styles	391
Tutorial: Creating Gradings	392
Exercise 1: Creating Feature Lines	392
Exercise 2: Assigning Feature Line Elevations	395
Exercise 3: Creating a Grading	397
Tutorial: Editing Gradings	400
Exercise 1: Editing the Grading Elevation	400
Exercise 2: Balancing Cut and Fill Volumes	402
Exercise 3: Editing the Grading Criteria	403
Tutorial: Grading from a Complex Building Footprint	404
Exercise 1: Simplifying a Building Footprint	405
Exercise 2: Grading from a Building Footprint to a Surface	408
Exercise 3: Filling Holes in a Grading	410
Tutorial: Using Feature Lines to Modify a Grading	412
Exercise 1: Smoothing Feature Line Arcs	412
Exercise 2: Adjusting Grading Triangulation with a Feature Line	414
Exercise 3: Working with Crossing Feature Lines	415
Chapter 12 Corridor Assembly Tutorials	421
Tutorial: Working with Assemblies	421
Exercise 1: Creating an Assembly	422
Exercise 2: Modifying the Subassembly Name Template	427
Exercise 3: Managing Assemblies and Subassemblies	430
Tutorial: Creating an Assembly with Conditions	433
Exercise 1: Examining the Existing Corridor in Section	433
Exercise 2: Adding Conditional Subassemblies to a Corridor Assembly	435
Exercise 3: Adjusting Conditional Subassembly Properties	443
Exercise 4: Rebuilding the Corridor and Examining the Results	446

	Tutorial: Saving and Sharing Corridor Assemblies	448
	Exercise 1: Saving Assemblies to a Tool Palette	449
	Exercise 2: Copying Assemblies to a Tool Catalog	451
	Exercise 3: Publishing a Tool Catalog	453
	Exercise 4: Installing a Tool Catalog	454
	Exercise 5: Moving Assemblies from a Tool Catalog to a Tool Palette or Drawing	455
Chapter 13	Corridors Tutorials	459
	Tutorial: Creating a Basic Corridor Model	459
	Tutorial: Creating a Corridor with a Transition Lane	463
	Exercise 1: Creating an Assembly with a Transition Lane	464
	Exercise 2: Creating a Corridor with a Transition Lane	467
	Tutorial: Creating a Divided Highway Corridor	471
	Exercise 1: Creating a Divided Highway Assembly	472
	Exercise 2: Creating a Divided Highway Corridor	476
	Tutorial: Viewing and Editing Corridor Sections	477
	Exercise 1: Viewing Corridor Sections	477
	Exercise 2: Editing Corridor Sections	480
	Tutorial: Viewing and Rendering a Corridor	483
	Exercise 1: Creating Corridor Surfaces	483
	Exercise 2: Creating Corridor Surface Boundaries	486
	Exercise 3: Visualizing a Corridor	490
Chapter 14	Intersection and Roundabout Tutorials	495
	Tutorial: Creating Intersections	496
	Exercise 1: Creating a Peer Road Intersection	496
	Exercise 2: Creating a Primary Road Intersection with Turn Lanes	503
	Exercise 3: Creating an Intersection with Existing Geometry	508
	Tutorial: Editing Intersections	516
	Exercise 1: Editing the Horizontal Geometry of an Intersection	516
	Exercise 2: Editing the Vertical Geometry of an Intersection	525
	Exercise 3: Creating and Editing a Corridor in the Intersection Area	533
	Tutorial: Working with Roundabouts	538
	Exercise 1: Creating a Roundabout	538
	Exercise 2: Adding an Approach Road to a Roundabout	546
	Exercise 3: Adding a Turn Slip Lane to a Roundabout	550
	Exercise 4: Editing Roundabout Components	553
	Exercise 5: Working with Roundabout Design Standards and Presets	560

Chapter 15	Sections Tutorials	569
	Tutorial: Creating Section Views	569
	Exercise 1: Creating Sample Lines	570
	Exercise 2: Creating Section Views	572
	Tutorial: Adding Data to a Section View	577
	Exercise 1: Projecting an Object onto a Section View	577
	Exercise 2: Adding a Section View Grade Label	586
	Exercise 3: Adding a Data Band to a Section View	587
Chapter 16	Material Calculation Tutorials	589
	Tutorial: Calculating Earthwork Volumes from Corridor Models	589
	Exercise 1: Reviewing Quantity Takeoff Criteria and Report Settings	590
	Exercise 2: Creating a Material List	591
	Exercise 3: Generating a Volume Report	593
	Tutorial: Working with Mass Haul Diagrams	594
	Exercise 1: Creating a Mass Haul Diagram	596
	Exercise 2: Balancing Mass Haul Volumes	598
	Exercise 3: Editing the Mass Haul Line Style	601
	Tutorial: Calculating and Reporting Quantities	603
	Exercise 1: Loading and Navigating a Pay Item List	604
	Exercise 2: Assigning Pay Item Codes to AutoCAD Objects	606
	Exercise 3: Assigning Pay Item Codes to Pipe Network Parts	612
	Exercise 4: Assigning Pay Item Codes to Corridors	616
	Exercise 5: Working with Quantity Reports	619
	Exercise 6: Working with Pay Item Formulas	622
	Exercise 7: Creating a Pay Item List	625
Chapter 17	Pipe Network Tutorials	629
	Tutorial: Creating a Pipe Network	629
	Exercise 1: Creating a Pipe Network from a Polyline	630
	Exercise 2: Creating a Pipe Network by Layout	635
	Exercise 3: Adding Parts to a Pipe Network	637
	Tutorial: Changing Pipe Network Properties	639
	Exercise 1: Adding Parts to the Parts List	639
	Exercise 2: Changing the Surface, Alignment, and Rules Configuration	640
	Exercise 3: Adding a Branch to a Pipe Network	642
	Tutorial: Viewing and Editing Pipe Networks	645
	Exercise 1: Drawing Pipe Network Parts in a Profile View	645
	Exercise 2: Adding Labels to Pipe Network Parts	646
	Exercise 3: Editing Pipe Network Parts in a Profile View	649

	Exercise 4: Overriding the Style of a Pipe Network Part in a Profile View	650
	Exercise 5: Viewing Pipe Network Parts in a Section View	652
	Exercise 6: Creating Pipe and Structure Tables	653
Chapter 18	Part Builder Tutorials	657
	Tutorial: Creating a Cylindrical Manhole Structure	657
	Exercise 1: Defining the New Part in the Structure Catalog	657
	Exercise 2: Defining the Manhole Geometry	659
	Exercise 3: Matching Offsets and Dimensions to Parameters	669
	Exercise 4: Verifying the New Part	673
	Tutorial: Creating a Drop Inlet Manhole Structure	676
	Exercise 1: Defining the New Part in the Structure Catalog	676
	Exercise 2: Defining the Manhole Geometry	678
	Exercise 3: Creating Profiles and Establishing Parameters	688
	Tutorial: Creating a Vault Structure	705
	Exercise 1: Defining the New Part in the Structure Catalog	706
	Exercise 2: Defining the Vault Top Section Geometry	707
	Exercise 3: Defining the Vault Box Geometry	717
	Exercise 4: Finalizing the Part	728
	Exercise 5: Using the New Part	735
Chapter 19	Labels and Tables Tutorials	739
	Tutorial: Preparing to Annotate a Drawing	740
	Exercise 1: Attaching Drawings as Xrefs for Annotation	740
	Exercise 2: Exploring the Annotation Tools on the Ribbon	743
	Tutorial: Adding and Editing Labels	744
	Exercise 1: Adding Labels in Groups	745
	Exercise 2: Manually Labeling an Object	752
	Exercise 3: Selecting and Moving Labels	755
	Exercise 4: Working with Label Properties	761
	Tutorial: Changing the Content of a Label	763
	Exercise 1: Overriding Label Text	764
	Exercise 2: Changing Label Content in the Drawing Settings	765
	Tutorial: Working with Tables and Tags	767
	Exercise 1: Creating a Parcel Area Table	768
	Exercise 2: Converting Labels to Tags	770
	Exercise 3: Renumbering Table Tags	774
	Tutorial: Working with Label Styles	776
	Exercise 1: Creating a Label Style	776
	Exercise 2: Using a Child Label Style	780
	Exercise 3: Controlling Label Appearance Using Layers	783
	Exercise 4: Changing the Dragged State of a Label	789

	Exercise 5: Changing a Label Style	793
	Exercise 6: Creating a Label Style that Refers to Another Object	797
	Tutorial: Using Expressions in Labels	801
	Exercise 1: Creating an Expression	802
	Exercise 2: Inserting an Expression Into a Label Style	803
Chapter 20	Plan Production Tutorials	805
	Tutorial: Preparing a Drawing for Plan and Profile Sheet Layout	805
	Exercise 1: Configuring Viewports	806
	Exercise 2: Creating View Frames	807
	Tutorial: Generating Sheets for Plotting	811
	Exercise 1: Creating Plan and Profile Sheets	811
	Exercise 2: Creating Section Sheets	814
	Tutorial Folder Locations	819
	Index	821

Welcome to the AutoCAD Civil 3D Tutorials

1

The following tutorial sets are included with AutoCAD Civil 3D 2011:

- [Getting Started Tutorials](#) (page 5). Learn about the application workspace and some important design tools and tasks.
- [Points Tutorials](#) (page 25). Learn how to work with coordinate geometry (COGO) points, which are the basis for modeling land surfaces.
- [Point Cloud Tutorials](#) (page 47). Learn how to work with point clouds, which are dense collections of point data that are obtained from LiDAR scanning
- [Surfaces Tutorials](#) (page 59). Learn the basics about creating and working with land surfaces.
- [Survey Tutorials](#) (page 129). Learn the basics about importing, creating, managing, and analyzing survey data.
- [Project Management Tutorials](#) (page 183). Learn how to use the AutoCAD Civil 3D project management features, including data shortcuts and Autodesk Vault.
- [Alignments Tutorials](#) (page 213). Learn about alignments, which are the basis for modeling roads.
- [Profiles Tutorials](#) (page 275). Learn the basics about viewing and designing the elevation profile of land surfaces along an alignment.
- [Parcels Tutorials](#) (page 341). Learn the basics about creating and editing parcels as well as working with the display of parcels.
- [Grading Tutorials](#) (page 387). Learn how to design the finished grade for land surfaces such as housing subdivisions and retail sites.
- [Corridor Assembly Tutorials](#) (page 421). Learn how to build and manage assemblies, which are cross sections that are placed incrementally along an alignment.
- [Corridors Tutorials](#) (page 459). Learn how to create simple and complex corridor designs.

- [Intersection and Roundabout Tutorials](#) (page 495). Learn how to create complex intersections that dynamically react to changes in the model.
- [Sections Tutorials](#) (page 569). Learn how to create cross sections of your corridor design, calculate cut and fill earthwork quantities, and create mass-haul diagrams.
- [Material Calculation Tutorials](#) (page 589). Learn how to calculate material quantities and generate reports, including pay item reports, earthworks reports, and mass haul diagrams.
- [Pipe Network Tutorials](#) (page 629). Learn how to create a pipe network using the specialized layout tools.
- [Part Builder Tutorials](#) (page 657). Learn how to design and model parts that are used in pipe networks.
- [Labels and Tables Tutorials](#) (page 739). Learn how to annotate AutoCAD Civil 3D objects using labels and tables.
- [Plan Production Tutorials](#) (page 805). Learn how to prepare your design drawings for plotting or publishing.

Each tutorial set contains exercises that are designed to explore the various features of AutoCAD Civil 3D.

The tutorial exercises are organized in a logical sequence, based on how you typically work with the different types of features. However, you may complete the exercises in any order you choose. After you begin an exercise, you should complete the steps in the order presented. The first steps provide you with the information you need for the later steps in that exercise.

NOTE All drawings used in these tutorials are available in the [tutorial drawings folder](#) (page 819) and all source data files are available in the [tutorial folder](#) (page 820). If you want to save your changes to the tutorial drawings as you work, save them to the [My Civil Tutorial Data folder](#) (page 819) so that you do not overwrite the original tutorial drawings.

Getting More Information

The step-by-step procedures in these tutorials provide instructions for using AutoCAD Civil 3D to complete tasks using the drawings provided.

The tutorials do not explore all of the features and commands of AutoCAD Civil 3D, nor do the tutorials identify all of the options associated with each

feature and command. To obtain more detailed information about AutoCAD Civil 3D features and commands, refer to the following documentation:

- *AutoCAD Civil 3D 2011 Help*
- *AutoCAD Civil 3D 2011 Best Practices Guide*

Setting Up the Workspace

Before you start the tutorials, you must set the appropriate workspace.

Workspaces are sets of commands that are grouped and organized so that you can work in a custom, task-oriented drawing environment. When you choose a workspace, only the ribbon tabs, toolbars, and secondary windows specified in that workspace are shown in the interface. To access other commands not shown in the ribbon, enter their command names on the command line.

The tutorials use the Civil 3D workspace. If you use a different workspace, some of the commands that are described may not be visible. To avoid confusion, it is recommended that you switch to the Civil 3D workspace before you begin the tutorials.

For more information, see the AutoCAD Civil 3D Help topic *Workspaces*.

To set up the workspace

- 1 On the command line, enter WORKSPACE.
- 2 At the Workspace Option prompt, enter C.
- 3 When prompted to enter the name of the workspace, enter Civil 3D.

Saving Your Tutorial Drawings

If you want to save your changes to the tutorial drawings as you work, you must create a folder in which to save drawing and data files before beginning the tutorial exercises.

Before you begin the tutorials:

- 1 Open Windows Explorer.
- 2 Navigate to the [Autodesk Documents folder](#) (page 819).
- 3 Click File menu ► New ► Folder.

4 Change the name of the new folder to My Civil Tutorial Data.

Getting Started Tutorials

2

These tutorials will get you started with the application workspace and some important design tools and tasks.

In AutoCAD Civil 3D, design data is organized as object collections in the Toolspace window. In Toolspace, the Prospector tab displays the hierarchy of design objects, such as points, surfaces, and alignments. The Settings tab displays a hierarchy of object styles, including styles for labels and tables.

The Panorama window displays data in a horizontally oriented grid, which makes it easier to see many columns at once. Each type of data displayed in Panorama uses a separate tab, known as a vista, that is specific to that data type.

There are many ways to view AutoCAD Civil 3D objects, including Visual Styles, Named Views, and the Object Viewer.

NOTE All drawings used in these tutorials are available in the [tutorial drawings folder](#) (page 819). If you want to save your work from these tutorials, save the drawings to the [My Civil Tutorial Data folder](#) (page 819) so that you do not overwrite the original drawings.

For more information, see the AutoCAD Civil 3D Help topic *The Civil 3D User Interface*.

Tutorial: Understanding the AutoCAD Civil 3D User Interface

In this tutorial, you will examine some of the major components of the AutoCAD Civil 3D user interface.

The AutoCAD Civil 3D user interface enhances the standard AutoCAD environment with additional tools for creating and managing civil design information.

Standard AutoCAD features, such as the command line and ribbon, work the same way in AutoCAD Civil 3D as they do in AutoCAD.

For more information, see the AutoCAD Civil 3D Help topic *The Civil 3D User Interface*.

Exercise 1: Finding Tools

In this exercise, you will learn how to locate the tools that are available for a given task.

The drawing you use contains AutoCAD Civil 3D objects to explore. The objects in this drawing are the site elements that you will create in the following tutorials.

For more information, see the AutoCAD Civil 3D Help topic *The Civil 3D User Interface*.

Explore the basic user interface elements

- 1 Open drawing *Intro-1.dwg*, which is available in the [tutorial drawings folder](#) (page 819).

This drawing contains an existing ground surface, two corridors that intersect, a storm sewer pipe network, and property parcels.

- 2 Examine the elements at the top of the AutoCAD Civil 3D window. Click the buttons as described in the following paragraphs to examine the tools that are contained in each element.



- Application Menu—Provides access to file-related commands, such as open, print, export, and publish.



- Quick Access Toolbar—Contains

frequently used commands. Click  and then More Commands to add an unlimited number of tools to the Quick Access toolbar.

NOTE You also can right-click a tool on the ribbon to send it to the Quick Access toolbar.



- InfoCenter—Enables you to search for information through key words, display the Communication Center panel for product updates and

announcements, display the Favorites panel to access saved topics, and access Help.

- Ribbon—Provides a single, compact location for commands that are relevant to the current task. The ribbon eliminates the need to display multiple toolbars, which reduces clutter in the application and maximizes the drawing space. In the top row, click  to successively minimize the ribbon display.

Explore the ribbon

- 1 On the Home tab, on the Create Design panel, click the bar at the bottom of the panel.

The panel expands to display additional tools. If  is displayed in the bottom bar of a ribbon panel, then additional tools are available.

- 2 Click the Modify and Analyze tabs.
Each of these tabs contains tools that are relevant to a category of tasks.
- 3 Click the Home tab.
The Home tab contains commands that are commonly used to create AutoCAD and AutoCAD Civil 3D objects.
- 4 In the drawing, click one of the contour lines to select the surface.

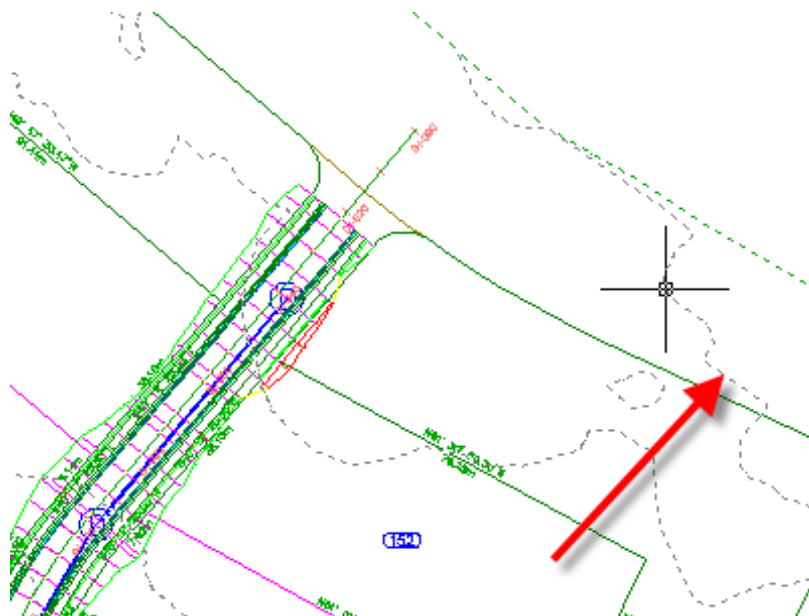

The TIN Surface tab is displayed on the ribbon. This is known as a *contextual tab*, and it contains all the tools related to surfaces. Depending on the type of object that is selected, different tools are displayed on the contextual tab. The tools on all AutoCAD Civil 3D contextual tabs are arranged in a similar series of panels:

- Labels and Tables
 - General Tools
 - Modify
 - Analyze
 - Object Tools
 - Launch Pad
- 5 Press Esc.
 - 6 Select the corridor.

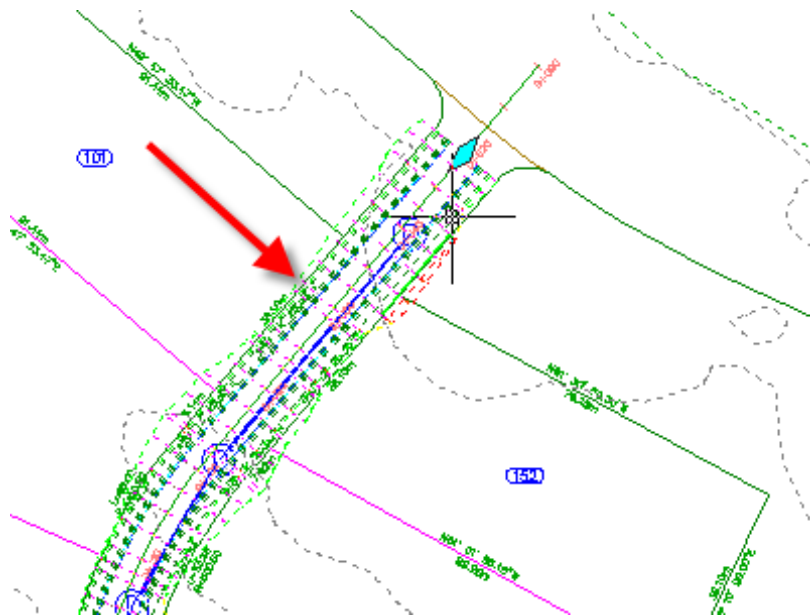

The Corridors tab is displayed on the ribbon. When an object is selected, the appropriate object contextual tab is available on the ribbon.

7 Press Esc.

The corridor is deselected, and the Home tab is active, and the contextual tab is removed.

To continue this tutorial, go to [Exercise 2: Understanding the Toolspace](#) (page 9).

Exercise 2: Understanding the Toolspace

In this exercise, you will learn how to use the AutoCAD Civil 3D Toolspace, which provides an object-oriented view of your engineering data.

For more information, see the AutoCAD Civil 3D Help topic *The Toolspace Window*.

This exercise continues from [Exercise 1: Finding Tools](#) (page 6).



Explore the Prospector tab

NOTE This tutorial uses *Intro-1.dwg* from the previous tutorial.

- 1 In Toolspace, click the Prospector tab.

Tooltpace can be docked, but it can also float. The Prospector tab provides you with a categorized view of all objects in the drawing.





NOTE If the Toolspace is not visible, enter ShowTS on the command line. The command line is not case sensitive, but in this document, commands are written in mixed case.

- 2 Click  next to the  Sites collection.

The drawing contains only one site, Site 1.

- 3 Expand the **Site 1** collection.

Notice that the Site 1 collection includes sub-collections for the following objects:

-  Alignments
-  Feature Lines
-  Grading Groups
-  Parcels

A site provides a logical grouping of objects that form part of the same design project, or are otherwise related. An object can belong to only one site.

- 4 Expand the  Parcels collection to see the names of individual parcels in Site 1.

Notice that the drawing includes different types of parcels, such as **Single-Family** and **Easement**.





- 5 Click a parcel name.

The parcel is displayed in a preview region of the Prospector tab.

NOTE If the preview does not work, you can activate it. First, ensure that the item preview button  at the top of the Prospector tab is pressed in. Then, right-click the Parcels collection and click Show Preview.

- 6 Right-click one of the **Single-Family** parcels. Click Properties.
The properties of the parcel are displayed in a dialog box. Note the detailed survey data shown on the Analysis tab. Review these properties as you wish, but do not change anything.
- 7 Click the Information tab. Change the Object Style from **Single-Family** to **Open Space**. Click OK.
Notice that the appearance of the parcel changes in the drawing, and in the item view preview. The name of the parcel changes in the Parcels collection on the Prospector tab. This happened because the style name is part of the naming template that is associated with the parcel.
A distinct set of custom styles for each AutoCAD Civil 3D object type can be saved in a drawing template. Object styles can be changed as needed to change the display of an object.

Explore the Settings tab

- 1 Click the Settings tab.
The Settings tab contains a tree structure of object styles and settings for the drawing. Like the Prospector tab, it has object collections at several levels.
- 2 Expand the Settings tree by clicking  next to the  *Intro-1*. Expand the  Parcel ►  Parcel Styles collection.
This collection displays the styles that are available in the current drawing.
- 3 Right-click the **Standard** parcel style. Click Edit.
The object style dialog box displays the current style attributes. Explore the contents of the tabs to see the various attributes that can be changed when you create a style.
- 4 Click Cancel.
Further exploration: Expand the Settings tree and look at several style objects and commands. Right-click various objects to see the available menu selections, but do not change anything.

To continue this tutorial, go to [Exercise 3: Using the Panorama Window](#) (page 12).

Exercise 3: Using the Panorama Window



In this exercise, you will learn how you can use and customize the Panorama window.

For more information, see the AutoCAD Civil 3D Help topic *The Panorama Window*.

This tutorial continues from [Exercise 2: Understanding the Toolspace](#) (page 9).

Display object data in the Panorama window

NOTE This tutorial uses *Intro-1.dwg* from the previous tutorial.

- 1 Use the  Pan and  Zoom controls to locate the beginning of the alignment and pipe network on the far right side of the site.
- 2 In the drawing, click the green alignment.

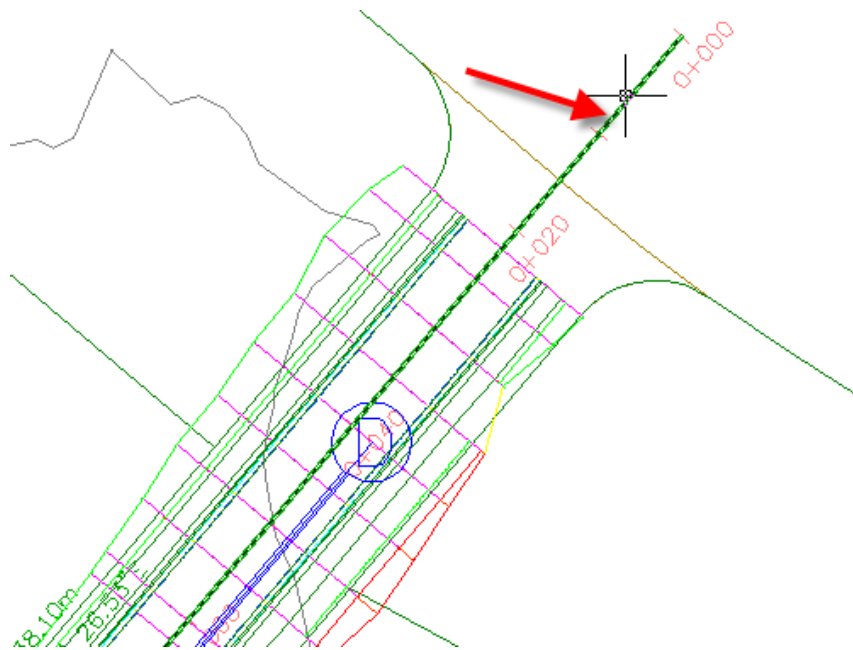

3 Click Alignment tab ► Modify panel ► Geometry Editor .

4 In the Alignment Layout Tools toolbar, click .

A table called Alignment Entities is displayed in a separate window called the *Panorama*. Notice that the table name appears on a tab. The main control bar is labeled Panorama. Each table in Panorama is called a *vista*. These tables are useful for editing object attributes. You can edit data in cells that appears as black text. You cannot edit data in cells that are shaded (unavailable). In the next few steps, you will learn to use some of the Panorama controls.



5 If the Panorama window covers the alignment, move it by clicking the middle part of the vertical control bar where you see the Panorama title, and then dragging the window to a new location.

TIP To move the Panorama window, hold down the Ctrl key to prevent the Panorama window from docking when you move it.

6 Press Esc to deselect the alignment.

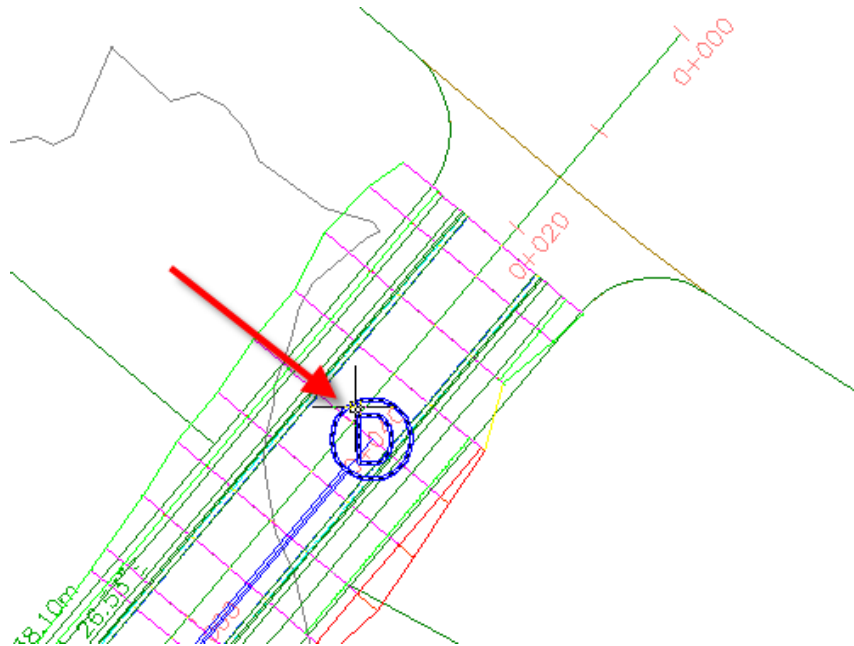
7 In the drawing, click the blue structure marker.







- 8 Click Pipe Networks tab ► Modify panel ► Edit Pipe Network .
- 9 In the Network Layout Tools toolbar, click .
Two additional tables, called Structures and Pipes are displayed in the Panorama window.
- 10 Click the three vista tabs in turn to switch from one table to the other. Bring the Alignment Entities table to the front.

Rearrange the columns of a vista

- 1 Scroll to the right until you see the Chord Length column.
- 2 Click the Chord Length column heading, drag the column to the left, and drop it to the right of the Length column.
Notice that each column heading is highlighted as the cursor passes through it. You can rearrange the columns like this to make the table easier to use.
- 3 Right-click the Radius column heading. Click Customize Columns.
The Customize Columns dialog box allows you to modify the appearance of the columns in the current vista. You can hide unnecessary columns by clearing the appropriate check boxes in the Visibility column, or change the width of columns using the Width column. Clicking the New button allows you to save a custom vista configuration for later use.
- 4 Click Cancel to close the Customize Columns dialog box.

Change the appearance of the Panorama window

- 1 On the Panorama control bar, click  to temporarily close the window.
- 2 Without clicking, move your pointer over the Panorama control bar.
The window opens while the pointer is on the bar. It closes when you move the pointer off the vista. This is *Auto-Hide Mode*, indicated by .
. It is useful when you want to periodically consult a table while working in the drawing.
- 3 Click  to turn off Auto-Hide Mode.

- 4 On the Panorama control bar, click . Click Transparency.
- 5 In the Transparency dialog box, move the General slider to a position in the middle of the range. Click OK.
- 6 Drag the Panorama window.
When you move the cursor away from the window, notice that you can see some drawing details through the table.
- 7 In Alignment Layout Tools toolbar, click .

The Pipes and Structures vistas remain open until you click  in the Network Layout Tools toolbar.

To continue to the next tutorial, go to [Tutorial: Using Basic Functionality](#) (page 15).

Tutorial: Using Basic Functionality

In this tutorial, you will learn how to navigate around AutoCAD Civil 3D and how to use some common features of the interface.

Panning and Zooming

You can use the zoom and pan commands to change the viewing scale of the drawing or move to a different area of the open drawing. This exercise demonstrates using the shortcut menu to pan and zoom. The pan and zoom commands also are available on the Home tab ► View panel.

Use shortcut menus to pan and zoom

- 1 Open *Intro-2.dwg*, which is located in the [tutorial drawings folder](#) (page 819).
- 2 Right-click the XGND surface name in the Prospector tree. Click Zoom To.
- 3 In the drawing, right-click and click Zoom. Click and drag upwards to zoom in closer to the surface.
- 4 To stop zooming and use the normal pointer, right-click and click Exit.
- 5 With no objects selected in the drawing, right-click in the drawing and click Pan.

- 6 Click and drag in any direction to move around the drawing.
- 7 To stop panning and use the normal pointer, right-click and click Exit.

Selecting and Deselecting

There are several ways to select objects in AutoCAD Civil 3D:

- To select an object, click it in the drawing window.
- To select an individual object that is part of a group of objects, press and hold Ctrl while clicking the object.
- To select several objects by enclosing them within a rectangular area, drag your cursor from left to right. A rectangle with a solid line appears. Only objects that are enclosed in the rectangular area are selected.
- To select several objects by crossing over them with a rectangular area, drag your cursor from right to left. A rectangle with a dashed line appears. Any objects that the dashed line crosses over are selected.

If you select the wrong object, press Esc to deselect it.

Experiment with the selection methods using the objects in drawing *Intro-2.dwg*.

Object Snapping

This standard AutoCAD feature is useful for precision drafting, when you want the line you are drawing to snap to entity edges or specific points. In these tutorials, you may prefer to use a freehand mode for drawing and editing objects, such as horizontal alignments and layout profiles.

Object snaps, also known as OSNAPs, can be used in either of two ways:

- Individual, or single-point OSNAPs— To snap to a specific type of point, hold the Shift key down and right-click. Select an object snap from the shortcut menu. The object snap stays in effect only for the next point that you click.
- Multiple, or running OSNAPs—You can toggle Object Snap on and off by clicking  on the status bar at the bottom of the main application window, or by pressing F3 or Ctrl+F. Object Snap is off when the button is in a raised position.

Experiment with OSNAPs

- 1 Press F1 to open AutoCAD Civil 3D Help.
- 2 In the left pane, click Search.
- 3 In the Type In The Word(s) To Search For field, enter Osnap.
- 4 In the Select A Section To Search list, select All Documentation.
- 5 Click Search. Select from the topics that are displayed.

In most cases, it is recommended that you also turn off other cursor controls on the status bar, such as Snap, Grid, and Ortho. The Model button, however, should remain on.

Dynamic Input

Dynamic input is an AutoCAD feature that displays prompts from the command line beside the cursor. Dynamic input provides a place for you to enter values when a command is active. For these tutorials, you may want to toggle off the dynamic input feature. To turn dynamic input off, click  on the status bar at the bottom of the main application window, or press F12.

For more information about dynamic input, see AutoCAD Help.

To continue to the next tutorial, go to [Viewing AutoCAD Civil 3D Objects](#) (page 17).

Tutorial: Viewing AutoCAD Civil 3D Objects

This tutorial demonstrates several ways to display objects in plan and model views.

There are a variety of ways to view AutoCAD Civil 3D objects. In this tutorial, you will learn how to use some of the most common methods, including viewports, named views, display representations, 3D views, and visual styles.

For more information, see the AutoCAD Help topic *Use 3D Viewing Tools*.

Exercise 1: Setting Up the Drawing Window

In this exercise, you will configure the drawing window, using named views and viewports.

For more information, see the AutoCAD Help topics *Save and Restore Views* and *Display Multiple Views in Model Space*.

Divide the drawing area into separate viewports

- 1** Open *Intro-2.dwg*, which is located in the [tutorial drawings folder](#) (page 819).
This drawing contains an existing ground surface, several alignments, and several profile views that contain existing ground and layout profiles.
- 2** Click View tab ► Viewports panel ► Viewport Configurations List ► Two: Vertical.
Two viewports are displayed. Each viewport is a separate window in which you can pan and zoom to different views of the drawing. You can create custom viewport configurations and save them for later use.
- 3** Click in each of the viewports.
Notice that as you click in a viewport, the border darkens to indicate which viewport is currently active. Click the viewport on the left side to make it active.
- 4** On the command line, enter ZE.
The surface and profile views are displayed in the left viewport.

Apply a saved drawing view

- 1** Click the viewport on the left side to make it active.
- 2** Click View tab ► Views panel ► Surface Extents.
The extents of the EG surface appears in the left viewport.

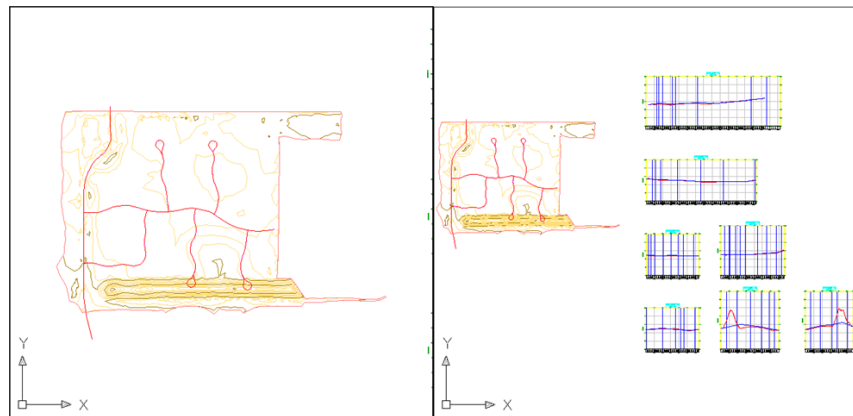

Three views have been created in this drawing. Each named view consists of a specific magnification, position, orientation, and layer status. Named views are saved with a drawing and can be used any time. When your drawing is displaying a specific view to which you want to return, you can save it as a named view by clicking View tab ► Views panel ► Named Views

To continue this tutorial, go to [Exercise 2: Changing the Display of an Object](#) (page 19).

Exercise 2: Changing the Display of an Object

In this tutorial, you will change the appearance of a surface by changing its style. You will examine the style settings that affect how an object is represented in plan, profile, and model views.

For more information, see the AutoCAD Civil 3D Help topic *Object Styles*.

This exercise continues from [Exercise 1: Setting Up the Drawing Window](#) (page 17).



Modify the display of a surface

NOTE This tutorial uses *Intro-2.dwg* from the previous tutorial.

- 1 In Toolspace, on the Prospector tab, expand the tree under the drawing name. Expand the Surfaces collection to see the surface name XGND.
- 2 Right-click the surface, XGND, and click Surface Properties.

- 3 In the Surface Properties dialog box, on the Information tab, under Surface Style, select a different style, such as Border & Elevations.
- 4 Click Apply.
The appearance of the surface now reflects the settings of the style you selected.
- 5 To show a different view of the surface, repeat steps 2 through 4, selecting a different style.
- 6 After you have explored other styles, set the original style, Visualization. Click Apply. Leave the Surface Properties dialog box open.

Examine the object style settings

- 1 In the Surface Properties dialog box, on the Information tab, in the Default Styles area, notice the Render Material list.
This list indicates the material that is applied to the surface object. When the surface is rendered in model view, the surface will be displayed using this material.
- 2 Click Cancel.
- 3 In the right viewport, zoom in to one of the profile grids. Select the blue, layout profile line. Right-click. Click Profile Properties.
- 4 In the Profile Properties dialog box, on the Information tab, in the Object Style area, click .
- 5 In the Profile Style dialog box, click the Display tab. In the View Direction list, make sure that Profile is selected.
The table identifies how the profile components are displayed in a profile view. The basic appearance of the individual object components is controlled on this tab. Components that have  in the Visibility column are visible when the profile is displayed in a profile view. The Layer, Color, Linetype, LT Scale, and Lineweight of the components are controlled on this table. In the drawing window, notice that the layout profile line is blue, as identified in the Color column.
Other AutoCAD Civil 3D object styles use the same basic structure to control display components. Most other objects, such as alignments, have a Plan view direction in place of the Profile view direction. The Plan view direction identifies how the object components are displayed in plan view.

- 6 In the View Direction list, select Model.

In the table, notice that the Layer and Color settings are different from the Profile view direction. When the layout profile line is viewed in model, it uses the display settings listed in this table.

NOTE In the View Direction list, notice that a Section selection is available. This View Direction specifies how the surface will be displayed when it is viewed as part of a corridor section. You will learn about viewing and editing corridor sections in the [Viewing and Editing Corridor Sections tutorial](#) (page 477).

- 7 Click Cancel to close the Profile Style and Profile Properties dialog boxes.
- 8 Press Esc to deselect the layout profile.

To continue this tutorial, go to [Exercise 3: Viewing a Drawing in Model](#) (page 21).

Exercise 3: Viewing a Drawing in Model

In this exercise, you will learn some ways to view drawing objects in three-dimensional views.

For more information, see the AutoCAD Help topic *Use 3D Viewing Tools*.

This exercise continues from [Exercise 2: Changing the Display of an Object](#) (page 19).

Examine object display in model views

NOTE This tutorial uses *Intro-2.dwg* from the previous tutorial.

- 1 Click the left viewport to make it active.
- 2 Click View panel ► Views panel ► views list ► SE Isometric.
A Southeast isometric view of the surface is displayed in the left viewport, and the right viewport stays in plan view.
- 3 Zoom in to the isometric view of the surface.
Notice the green and blue lines. The green lines are the layout profiles that you examined in profile view. They are green because the Model view direction in its style indicated that they will display as green. The

blue lines under the surface are the horizontal alignments from which the profiles were created.

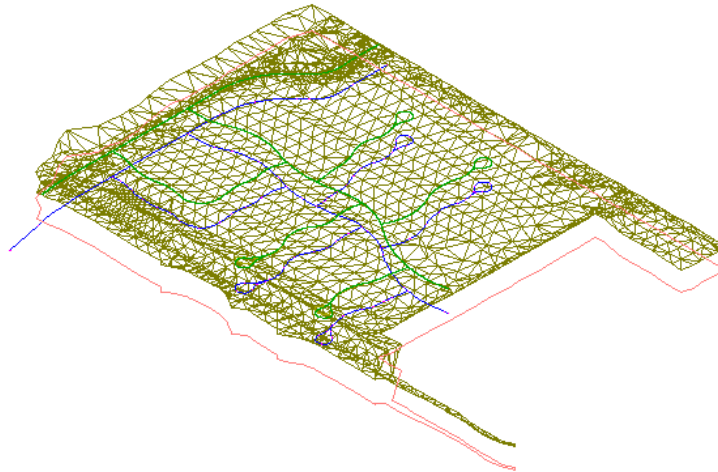

Change the visual style of the surface

- 1 Click View panel ► Views panel  Visual Styles drop-down ► 3D Wireframe.

AutoCAD *visual styles* give a fast, basic visualization of an object that is useful for on-screen presentation in AutoCAD Civil 3D. The 3D Wireframe visual style displays the surface in model view without applying a fill material to the object.

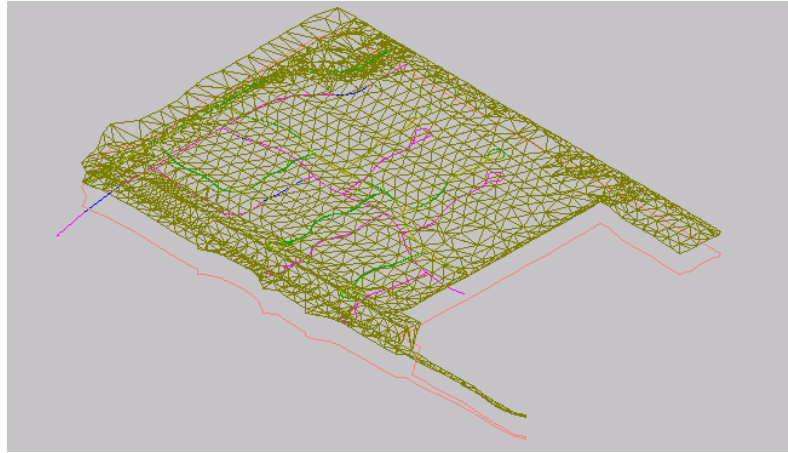

Notice that a cube is displayed in the upper right-hand corner. This is the AutoCAD ViewCube, which provides visual feedback of the current orientation of a model. You can use the ViewCube to adjust the viewpoint of the model when a visual style has been applied.

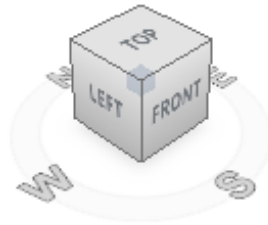

2 Click a corner of the ViewCube, and drag it to a new position. Experiment with dragging the ViewCube to various positions. When you are finished, click  to return the model and ViewCube to their original positions.

3 Click View panel ► Views panel  Visual Styles drop-down ► Conceptual.

The Conceptual visual style shades the object and smooths the edges between polygon faces. The shading in this style uses the Gooch face style, a transition between cool and warm colors rather than dark to light. The effect is not realistic, but it can make the details of the model easy to see.

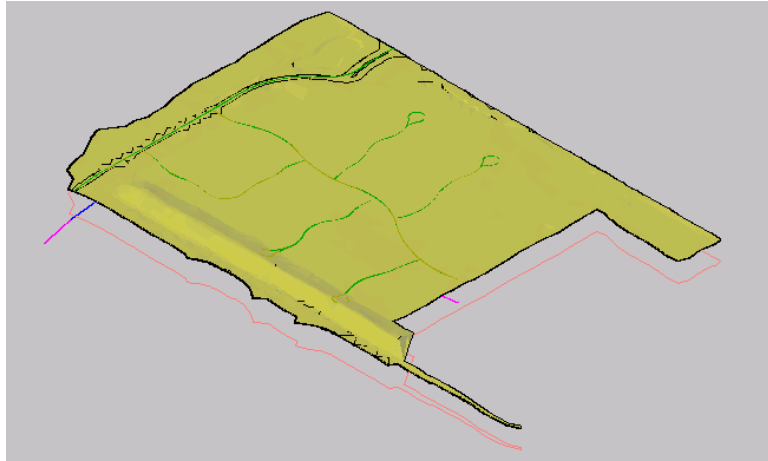

- 4 Click View panel ► Views panel  Visual Styles drop-down ► Realistic. The Realistic visual style shades the surface and smooths the edges between polygon faces. The render material that is specified in the surface style is displayed.

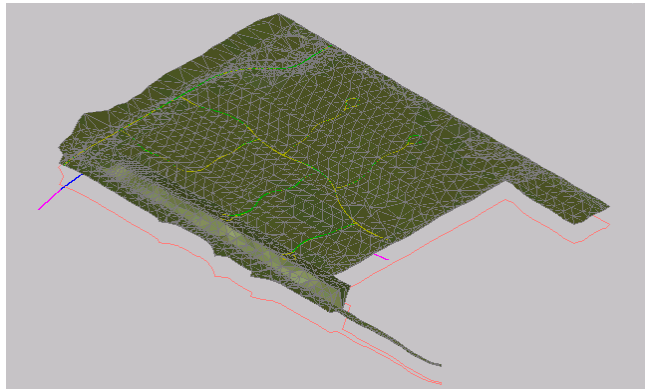

Points Tutorials

3

These tutorials will get you started working with coordinate geometry (COGO) points, which are the basis for modeling land surfaces. These tutorials demonstrate how to import survey points into a drawing from a database, and how to classify a large set of points into more manageable groups.

Before you import a large set of points, it is a good idea to structure your drawing environment so that as the points are created, they are sorted into meaningful groups, with appropriate styles and other attributes.

NOTE All drawings used in these tutorials are available in the [tutorial drawings folder](#) (page 819). If you want to save your work from these tutorials, save the drawings to the [My Civil Tutorial Data folder](#) (page 819) so that you do not overwrite the original drawings.

For more information, see the AutoCAD Civil 3D Help topic *Understanding Points*.

Tutorial: Creating Point Data

This tutorial demonstrates several useful setup tasks for organizing a large set of points.

In this tutorial, you will learn about managing a set of points related to stormwater manholes and detention ponds. You will create description keys and point groups to sort the points as they are imported into a drawing. Then, you will import the points from an existing file.

Description keys can help you automate many point-handling tasks at the time that points are created or imported. A description key uses the raw description code of a point to determine how to process the point. For example, you can configure a description key to apply different styles or place points on different drawing layers.

You can classify a set of points into several *point groups*, based on the type of point, elevation, date of creation, source, or other criteria. Then you can run

various queries or operations for point display against a point group, rather than the whole set.

Points can be *imported* from a text file or a Microsoft Access database. Data created in Autodesk Land Desktop can be migrated to AutoCAD Civil 3D by importing points directly from a project database.

You can create a large point set and organize it later. However, it is usually more efficient to classify points into several groups as they are being created.

For more information, see the AutoCAD Civil 3D Help topic *Creating Points*.

Exercise 1: Creating Description Keys

In this exercise, you will create description keys to sort the points as they are imported into a drawing.

For more information, see the AutoCAD Civil 3D Help topic *Description Keys*.

Create a description key set

- 1 Open *Points-1.dwg*, which is located in the [tutorial drawings folder](#) (page 819).
- 2 In Toolspace, on the Settings tab, expand the Point collection.
- 3 Right-click Description Key Sets. Click New.
- 4 In the Description Key Set dialog box, Name field, enter Stormwater Keys.
- 5 In the Description field, enter Stormwater manhole and pond points.
- 6 Click OK.

The new description key set is created.

Create description keys

- 1 In Toolspace, on the Settings tab, expand the Description Key Sets collection. Right-click Stormwater Keys. Click Edit Keys. The DescKey Editor vista is displayed in the Panorama window.
In the DescKey Editor, you will enter the raw description codes, and specify how AutoCAD Civil 3D handles new points that have these codes. All entries in the Code column of the DescKey Editor are case sensitive.
- 2 In DescKey Editor, in the Code column, click the default entry. Change it to POND*.

The asterisk is a wild-card character. The asterisk causes any imported point with a description code that begins with POND, followed by any other characters, to be handled according to the settings in this table row.

- 3 In both the Style and Point Label Style columns, clear the check box to deactivate these settings.

Clearing these settings allows you to control these settings by using point group properties.

NOTE The Format column contains the entry \$*, which specifies that a point's raw description is copied without changes and used for the full description in the point label. This is an acceptable setting for the POND points.

- 4 In the Layer column, select the check box. Click the cell to open the Layer Selection dialog box.
- 5 In the Layer Selection dialog box, select V-NODE-STRM. Click OK.
This setting means that the POND points reference the V-NODE-STRM layer for their display attributes. In the next few steps, you create another description key.
- 6 In the Code column, right-click the POND* entry. Click New.
- 7 In the new description key, click the default Code entry and change it to MHST*.
- 8 Set the same styles and layer as you did for POND* by repeating Steps 3 through 5.
- 9 In the Format column, enter STORM MH.
This setting ensures that points with a raw description of MHST* (stormwater manholes) are labeled in the drawing as STORM MH.
- 10 Click  to save the description keys and close the editor.

To continue this tutorial, go to [Exercise 2: Creating Point Groups](#) (page 27).

Exercise 2: Creating Point Groups

In this exercise, you will create point groups to sort the points as they are imported into a drawing.

For more information, see the AutoCAD Civil 3D Help topic *Point Groups*.

This exercise continues from [Exercise 1: Creating Description Keys](#) (page 26).

Create point groups

NOTE This exercise uses *Points-1.dwg* with the modifications you made in the previous exercise.

- 1 In Toolspace, on the Prospector tab, right-click the Point Groups collection. Click New.
- 2 In the Point Group Properties dialog box, on the Information tab, in the Name field, enter Detention Pond. Optionally, enter a short description in the Description field.
- 3 On the Raw Desc Matching tab, select POND*. Click Apply.
This option specifies that all points with the POND* raw description are added to the Detention Pond point group.
Notice how the description key setting is recorded on both the Include and Query Builder tabs. If you know SQL, you can see how you could add more criteria to the Query Builder tab to select a more specific set of points for the point group.
- 4 Click OK.
- 5 Create another point group by repeating Steps 1 through 4, but use the following parameters:
Name: Storm Manholes
Raw Desc Matching: MHST*
Your drawing should now contain the same description keys and point groups shown in sample drawing *Points-1a.dwg*.

NOTE The *_All Points* point group is created automatically. A point can belong to other point groups in the drawing, but it is always a member of the *_All Points* point group. For more information, see the AutoCAD Civil 3D Help topic *The _All Points Point Group*.

Change the point group label style

- 1 In Toolspace, on the Prospector tab, expand the Point Groups collection.
- 2 Right-click the *_All Points* collection. Click Properties.
- 3 In the Point Group Properties dialog box, on the Information tab, change the Point Label Style to Standard.

- 4 Click OK to close the Point Group Properties dialog box.

To continue this tutorial, go to [Exercise 3: Importing Points from a Database](#) (page 29).

Exercise 3: Importing Points from a Database



In this exercise, you will import points from a database to a drawing that uses description keys to sort points into groups.

For more information, see the AutoCAD Civil 3D Help topic *Importing and Exporting Points*.

This exercise continues from [Exercise 2: Creating Point Groups](#) (page 27).

Import points from a database



NOTE This exercise uses *Points-1.dwg* with the modifications you made in the previous exercise, or you can open *Points-1a.dwg* from the [tutorial drawings folder](#) (page 819).

- 1 In Toolspace, on the Prospector tab, right-click Points. Click Create.
- 2 In the Create Points dialog box, click . Expand the Default Layer parameter, then change the value to V-NODE.
- 3 In the Create Points dialog box, click  Import Points.
- 4 In the Format list, select External Project Point Database.
- 5 Click . Browse to the [tutorial folder](#) (page 820). Select *points.mdb*. Click Open.
- 6 In the Import Points dialog box, clear the Advanced Options check boxes.
- 7 Click OK.
The points are imported.
- 8 In Toolspace, on the Prospector tab, right-click the _All Points point group. Click Zoom To.

The points are displayed both in the drawing and in tabular form in the Toolspace list view. In the drawing window, if you move the cursor over a point, a tooltip displays basic data about the point. Notice that the two stormwater point groups appear to be empty. This is because they have

not been updated with their new content. In the next few steps, you will see how AutoCAD Civil 3D provides several ways to check the point data before adding it to your drawing.

Update point groups

- 1 Right-click the Point Groups collection. Click Properties.
The Point Groups dialog box is displayed. Point groups are listed here according to their display order, with the highest priority group at the top. Arrows at the side of the dialog box allow you to change the display order. The icon  indicates that an update is pending for a point group.
- 2 To show the contents of the update for each point group, click . Review the list of points that the application is prepared to add to the Storm Manholes and Detention Pond point groups.
- 3 In the Point Group Changes dialog box, click Close.
- 4 To update the point groups, click . Click OK.
Alternatively, you can right-click the Point Groups collection and click Update.
The point groups update. Now, you can display their points in the list view and zoom to them in the drawing.
- 5 Right-click a point group. Click Edit Points.
The points are displayed in the Point Editor table. Review and change their attributes.

NOTE For information about changing the contents and display of the Panorama window, see the [Using the Panorama Window tutorial](#) (page 12).

To continue to the next tutorial, go to [Displaying and Editing Points](#) (page 30).

Tutorial: Displaying and Editing Points

This tutorial demonstrates how to use point groups, layers, external references, and styles to display points. It also explains the various ways to edit points using standard AutoCAD tools.

You can use *point groups* to organize points and to control their appearance in a drawing. While points are independent objects that do not have to be categorized into specific point groups, every point in a drawing is always part of the `_All Points` point group. The point group *display order* determines which point group's properties take precedence. For example, if a point belongs to a point group that is higher in the display order than the `_All Points` point group, the higher group's properties override the properties set in the `_All Points` point group.

The *point layer* controls the display attributes of the point. To see this, open the Point Group Properties dialog box, click the Point List tab, and look at the Point Layer column. This column also appears in the Prospector list view when the point group is selected. The point layer can be assigned by using a description key. If a point layer is not assigned during creation, points are placed on the default point layer specified in the drawing settings.

An external reference drawing (*xref*) is a useful way to see points in relation to other surface features without adding these features to your drawing. You can reference another drawing and make it appear as an underlay in your current drawing. Then, you can detach the external drawing when you no longer need it.

Changing the point or label style of a point group can help you distinguish these points more easily from other points in the drawing.

Each point is an object that can be individually selected and manipulated. Point objects have commands, property attributes, and grip behavior that are similar to other AutoCAD entities.

For more information, see the AutoCAD Civil 3D Help topic *Controlling the Appearance of Points in a Drawing*.

Exercise 1: Displaying an Externally Referenced Drawing

In this exercise, you will use a standard AutoCAD operation to display another drawing of the region around your set of points.

For more information, see the AutoCAD Help topic *Attach Drawing References (Xrefs)*.

This exercise continues from the [Creating Point Data](#) (page 25) tutorial.

Display an externally referenced drawing

NOTE This exercise uses *Points-1 a.dwg* with the modifications you made in the previous tutorial, or you can open *Points-2.dwg* from the [tutorial drawings folder](#) (page 819).

- 1 Click Insert tab ► Reference panel ►  Attach.
- 2 In the Select Reference File dialog box, make sure that Files Of Type is set to Drawing (*.dwg). Navigate to the [tutorial drawings folder](#) (page 819) and open *Existing Basemap.dwg*. Select it and click Open.
- 3 In the External Reference dialog box, specify the following parameters:
 - Reference Type: Overlay
 - Insertion Point: Cleared
 - Scale: Cleared
 - Rotation: Cleared
- 4 Click OK.

The basemap appears on the screen, allowing you to see the points of interest in relation to the road design and other contextual features. This external reference remains separate from your drawing. There is no risk of unexpected changes to your drawing. In a later exercise, you will learn how to detach the external reference.

To continue this tutorial, go to [Exercise 2: Changing the Style of a Point Group](#) (page 32).

Exercise 2: Changing the Style of a Point Group

In this exercise, you will change the style of a point group. Point styles can help you distinguish the points more easily from other points in the drawing.

For more information, see the AutoCAD Civil 3D Help topic *Changing the Properties of a Point Group*.

This exercise continues from [Exercise 1: Displaying an Externally Referenced Drawing](#) (page 31).

Change the style of a point group

NOTE This exercise uses *Points-2.dwg* and *Existing Basemap.dwg* with the modifications you made in the previous exercise.

- 1 Zoom in to the upper left area of the screen where you can clearly see the labels for several POND points and one or more STORM MH points. Notice that both types of points use the same marker style (X).
- 2 In Toolspace, on the Prospector tab, right-click the point group _All Points. Click Properties.
- 3 In the Point Group Properties dialog box, on the Information tab, change the Point Label Style to <none>.
- 4 Click OK.
Labels for all points that do not have a label style set in another point group are hidden. The point markers are still visible because markers are controlled by the point style, which you did not change.
- 5 In Toolspace, on the Prospector tab, right-click the point group Storm Manholes. Click Properties.
- 6 In the Point Group Properties dialog box, on the Information tab, change the Point Style to Storm Sewer Manhole.
- 7 Click OK.
The stormwater manhole points are now marked with the symbol defined in the Storm Sewer Manhole point style.

To continue this tutorial, go to [Exercise 3: Changing Point Group Display Order](#) (page 33).

Exercise 3: Changing Point Group Display Order

In this exercise, you will use the point group display order to change the appearance of points.

For more information, see the AutoCAD Civil 3D Help topic *Changing the Point Group Display Order*.

Change the point group display order

NOTE This exercise uses *Points-2.dwg* and *Existing Basemap.dwg* with the modifications you made in the previous exercise.

- 1 In Toolspace, on the Prospector tab, expand the Point Groups collection. Notice the order of the point groups in the Prospector tree. The point group display order determines how points that belong to more than one point group are displayed in a drawing. When a drawing is opened or regenerated, AutoCAD Civil 3D searches down the point group display order to determine how the point will appear.

For example, if a point belongs to all three groups, AutoCAD Civil 3D will first look in the Storm Manholes point to determine if a point label style has been assigned to that point group. If it has not, AutoCAD Civil 3D will look in the Detention Pond point group, and then the `_All Points` group until the point label style setting is found.
- 2 In Toolspace, on the Prospector tab, right-click the Point Groups collection. Click Properties.
- 3 In the Point Groups dialog box, select the Storm Manholes point group.
- 4 Click  to move the Storm Manholes point group to the bottom of the display order.
- 5 Click OK.

Notice that the point style for the STORM MH points has changed to an X, and the label has disappeared. This happened because when the Storm Manholes point group was placed below the `_All Points` point group, the `_All Points` point group's point style and point label style settings took precedence over those of the Storm Manholes point group.
- 6 In Toolspace, on the Prospector tab, right-click the `_All Points` point group. Click Properties.
- 7 In the Point Group Properties dialog box, on the Overrides tab, select the Point Label Style box. Click OK.

This option ensures that the Point Label Style setting of the point group overrides the Point Label Style setting of the individual points included in the point group.
- 8 In Toolspace, on the Prospector tab, right-click the Point Groups collection. Click Properties.

- 9 In the Point Groups dialog box, select the _All Points point group. Click  to move the _All Points point group to the top of the display order.
- 10 Click OK.
Notice that all point labels in the drawing are hidden. This happened because the _All Points point group's point label style set to <none>, and you placed the _All Points point group at the top of the display order.

To continue this tutorial, go to [Exercise 4: Removing an Externally Referenced Drawing](#) (page 35).

Exercise 4: Removing an Externally Referenced Drawing

In this exercise, you will remove the externally referenced drawing that you added previously.

For more information, see the AutoCAD Help topic *Detach Referenced Drawings*.

This exercise continues from [Exercise 3: Changing Point Group Display Order](#) (page 33).

Remove an externally referenced drawing

NOTE This exercise uses *Points-2.dwg* and *Existing Basemap.dwg* with the modifications you made in the previous exercise.

- 1 Click any entity in *Existing Basemap.dwg* to select the whole drawing.
- 2 Right-click, and click Xref Manager.
- 3 In the External References dialog box, right-click the reference name Existing Basemap. Click Detach.
The reference drawing disappears from view.
- 4 Close the External References dialog box.

To continue this tutorial, go to [Exercise 5: Editing Points](#) (page 35).

Exercise 5: Editing Points

In this exercise, you will use standard AutoCAD commands to move and rotate point objects to improve their position in the drawing.

For more information, see the AutoCAD Civil 3D Help topic *Editing Points*.

Change the point style

NOTE This exercise uses *Points-3.dwg*, which is similar to the drawing you used in the other exercises in the [Displaying and Editing Points](#) (page 30) tutorial.

- 1 Open *Points-3.dwg*, which is located in the [tutorial drawings folder](#) (page 819).
- 2 Locate point 992 near the right side of the drawing.
Notice that the label for point 992 is obscured by the hatching. In the next few steps, you will change the point marker style. You will rotate the point marker so that it is parallel with the nearby road, and then move the label to a more readable location.
- 3 Select point 992. Right-click. Click Properties. The AutoCAD Properties palette displays the properties of individual points.
- 4 Under Information, select Catch Basin in the Style property.





Rotate the point

- 1 In the drawing window, click the  grip. The grip turns red.
This is the point rotation grip, which rotates the point marker around the center point.

TIP To rotate a group of points, use the AutoCAD ROTATE command.

- 2 Rotate the point clockwise until the point marker is parallel to the edge of the road, then click to position the point.
The point marker now matches the angle of the road, but the label is still obscured by the hatching. You will correct this in the following steps.

Drag the point label

- 1 Examine the  grip that is offset from the center of the point.
- 2 This is the drag label grip. Click the  grip above the drag label grip.
This toggles the display of the drag label grip. Three  grips are available. These grips can be used to drag each line in the point label independently.
- 3 Click the  grip to return the drag label grip to its original state.

- 4 Click the drag label grip.
- 5 Drag the label down and to the left, until it is in an unobstructed area. Click to place the label in its new orientation.

To continue to the next tutorial, go to [Adding User-Defined Properties to Points](#) (page 37).

Tutorial: Adding User-Defined Properties to Points

This tutorial demonstrates how to add custom properties to points.

A *user-defined property* can be any useful attribute, such as date of acquisition or source. To create user-defined properties, you first create a property classification, which is a container for one or more related properties.

If you want to define a value for a point, but the applicable property does not exist, you can define it as a custom, user-defined property.

You assign classifications and their associated properties to the points in your drawing using point groups. After you have added the user-defined properties to a point group, you can add values for each property either by editing the properties of individual points or by importing values from an external point file.

For more information, see the AutoCAD Civil 3D Help topic *User-Defined Property Classifications*.

Exercise 1: Creating User-Defined Properties

In this exercise, you will learn how to create a user-defined property classification and add items to it.

For more information, see the AutoCAD Civil 3D Help topic *User-Defined Property Classifications*.

Create a user-defined property classification

- 1 Open *Points-4a.dwg*, which is located in the [tutorial drawings folder](#) (page 819).

The drawing is similar to the ones you used earlier in the Points tutorials, except only the points for storm manholes and the detention pond are visible.

- 2 In Toolspace, on the Settings tab, expand the Point collection. Right-click User-Defined Property Classifications. Click New.
- 3 In the User-Defined Property Classification dialog box, enter Manhole UDP.
- 4 Click OK.
The new classification is created and added to the list of user-defined property classifications.
- 5 Repeat Steps 2 to 4 to create an additional user-defined property classification named Trees.

Define classification properties

- 1 On the Settings tab, expand User-Defined Property Classifications. Right-click Manhole UDP. Click New.
- 2 In the New User-Defined Property dialog box, for Name, enter MH_Pipe In Invert.
- 3 In the Property Field Type list, select Elevation.
- 4 Use the default values for all other properties. Click OK.
The property is added to the list of Manhole UDP properties.
- 5 Repeat Steps 1 to 4 to add additional properties to the Manhole UDP classification, using the following parameters:

NOTE The next exercise uses *Points-4b.dwg*, which contains all of the properties and classifications. To save time, you can skip Steps 5 and 6 and proceed to [Exercise 2: Creating a Label Style That Displays a User-Defined Property](#) (page 39).

Name	Property Field Type
MH_Material	String
MH_Diameter	Dimension
MH_Pipe In Diameter	Dimension
MH_Pipe In Material	String

Name	Property Field Type
MH_Pipe Out Invert	Elevation
MH_Pipe Out Dia- meter	Dimension
MH_Pipe Out Mater- ial	String

- 6** Repeat Steps 1 to 4 to add properties to the Trees classification using the following parameters:

Name	Property Field Type
Tree_Common Name	String
Tree_Genus	String
Tree_Species	String
Tree_Diameter	Dimension
Tree_Height	Distance

To continue this tutorial, go to [Exercise 2: Creating a Label Style That Displays a User-Defined Property](#) (page 39).



Exercise 2: Creating a Label Style That Displays a User-Defined Property

In this exercise, you will create a label style that displays user-defined property information for a point.

For more information, see the AutoCAD Civil 3D Help topic *Creating and Editing Label Styles*.

This exercise continues from [Exercise 1: Creating User-Defined Properties](#) (page 37).

Create a label style that displays user-defined property information

- 1 Open *Points-4b.dwg*, which is located in the [tutorial drawings folder](#) (page 819).
- 2 In Toolspace, on the Settings tab, expand the Point collection. Expand the Label Styles collection.
- 3 Under Label Styles, right-click Standard. Click Copy.
- 4 In the Label Style Composer, on the Information tab, for Name, enter Manhole UDP.
- 5 On the Layout tab, in the Preview list on the upper right side of the tab, select Point Label Style.
Now, any edits you make to the point label style will be displayed in the preview pane.
- 6 Click  to create a text component for the label.
- 7 For the new text component, specify the following parameters:
 - Name: Invert In
 - Anchor Component: Point Description
 - Anchor Point: Bottom Left
 - Text Attachment: Top Left
- 8 Under Text, for Contents, click the default value. Click .
- 9 In the Text Component Editor – Label Text dialog box, on the Properties tab, specify the following parameters:
 - Properties: MH_Pipe In Invert
 - Precision: 0.01
- 10 Click .
- 11 In the text editing window, delete the text “Label Text” from the label. Enter Invert In: before the property field, which is enclosed in angle brackets(<>). The text in the editor should look like this:

```
Invert In: <[MH_Pipe In Invert(Uft|P2|RN|AP|GC|UN|Sn|DF)]>
```
- 12 Click OK.

13 In the preview pane, your label should look like this:



1
X100.00
RANDOM
Invert In: 0.00

14 Click OK.

To continue this tutorial, go to [Exercise 3: Assigning User-Defined Properties to Points](#) (page 41).

Exercise 3: Assigning User-Defined Properties to Points

In this exercise, you will use point groups to associate user-defined properties with points in your drawing.

For more information, see the AutoCAD Civil 3D Help topic *Assigning User-Defined Properties to Point Groups*.

This exercise continues from [Exercise 2: Creating a Label Style That Displays a User-Defined Property](#) (page 39).

Assign user-defined properties to points

- 1 Open *Points-4c.dwg*, which is located in the [tutorial drawings folder](#) (page 819).
- 2 In Toolspace, on the Prospector tab, click Point Groups.
- 3 In the item view, click the Storm Manholes entry. In the Classification column, select Manhole UDP.

Apply the user-defined property point label style

- 1 In the Prospector tree view, expand Point Groups. Click Storm Manholes.
- 2 In the item view, right-click in a column heading.
- 3 Clear the check mark from all items in the list, except the following:
 - Point Number
 - Point Label Style

- MH_Pipe In Invert
- MH_Pipe In Material

Clearing the check boxes turns off the display of columns you do not need to see for this exercise.

- 4 Click the row for point 307.
- 5 Click the Point Label Style cell to display the Select Label Style dialog box.
- 6 In the Select Label Style dialog box, select Manhole UDP as the label style. Click OK.
- 7 Repeat Steps 4 to 6 to apply the Manhole UDP for point 667.

Specify user-defined property values

- 1 For point 307, click the MH_Pipe In Invert cell. Enter 93.05.
- 2 Right-click the row for point 307. Click Zoom To.
The value is displayed with the other point information in the drawing window.
- 3 For point 667, click the MH_Pipe In Invert cell. Enter 93.00.
- 4 Right-click the entry for point 667. Click Zoom To.

To continue this tutorial, go to [Exercise 4: Importing Points with User-Defined Properties](#) (page 42).

Exercise 4: Importing Points with User-Defined Properties

In this exercise, you will create a custom point file format, and then import point information that includes user-defined properties from an external file.



For more information, see the AutoCAD Civil 3D Help topic *Importing and Exporting User-Defined Property Classifications*.

This exercise continues from [Exercise 3: Assigning User-Defined Properties to Points](#) (page 41).

Create a point file format for importing user-defined properties

- 1 Open *Points-4d.dwg*, which is located in the [tutorial drawings folder](#) (page 819).
- 2 In Toolspace, on the Settings tab, expand the Point collection. Right-click Point File Formats. Click New.
- 3 In the Point File Formats – Select Format Type dialog box, select User Point File. Click OK.
- 4 In the Point File Format dialog box, specify the following properties:
 - Format Name: Manhole Data
 - Comment Tag: #
 - Format Options: Delimited By
 - Delimited By: , (a comma)
- 5 In the table of column names, click the first column heading (labeled <unused>).
- 6 In the Point File Formats – Select Column Name dialog box, in the Column Name list, select Point Number. Click OK.
- 7 Repeat steps 5 and 6 to name additional columns using the following values:
 - Column 2: MH_Material
 - Column 3: MH_Diameter
 - Column 4: MH_Pipe In Invert
 - Column 5: MH_Pipe In Diameter
 - Column 6: MH_Pipe In Material
 - Column 7: MH_Pipe Out Invert
 - Column 8: MH_Pipe Out Diameter
 - Column 9: MH_Pipe Out Material
- 8 Click OK.

Import user-defined property data from a text file

- 1 In Toolspace, on the Prospector tab, ensure that the Point Groups collection is expanded, and select the Storm Manholes group.
In the item view, note that this group contains only nine points, and some of the data columns are blank.
- 2 In Toolspace, on the Prospector tab, right-click Points. Click Create.
- 3 In the Create Points dialog box, click  Import Points.
- 4 In the Import Points dialog box, in the Format list, select Manhole Data.
- 5 Click  . Browse to the [tutorial folder](#) (page 820). Select *manhole_data.txt*. Click Open.
- 6 Click OK.
- 7 In the Duplicate Point Number dialog box, in the Resolution list, select Merge. Click OK.
The point data is imported.
- 8 On the Prospector tab, click the Storm Manholes point group.
The point data from the file import is displayed in the item view, including specific values for manhole data.
- 9 Close the Create Points dialog box.

To continue this tutorial, go to [Exercise 5: Querying User-Defined Property Information](#) (page 44).

Exercise 5: Querying User-Defined Property Information

In this exercise, you will create a point group. The list of points included in the group is determined by a query that contains user-defined properties.

For more information, see the AutoCAD Civil 3D Help topic *Creating a Point Group Using the Query Builder*.

This exercise continues from [Exercise 4: Importing Points with User-Defined Properties](#) (page 42).

Create a point query

- 1 Open *Points-4e.dwg*, which is located in the [tutorial drawings folder](#) (page 819).
- 2 In Toolspace, on the Prospector tab, right-click Point Groups. Click New.
- 3 In the Point Group Properties dialog box, on the Information tab, for Name, enter Storm Manholes - Invert In.
- 4 On the Query Builder tab, select Modify Query.
- 5 Right-click the Query Builder table. Click Insert Row.
- 6 Click the row you created. Click Name in the Property column. In the Property list, select MH_Pipe In Invert.
- 7 Click the Operator value. In the Operator list, select < (less than).
- 8 Click the Value value. Enter 93.
- 9 Click OK.
- 10 On the Prospector tab, click Storm Manholes - Invert In.
A list of points that match your query is displayed in the item view. Points number 307 and 667 are excluded, because in a previous exercise you set their values for MH_Pipe In Invert to 93.05 and 93.00.

Point Cloud Tutorials

4

These tutorials will get you started working with point clouds, which are dense collections of point data that are obtained from LiDAR scanning.

NOTE All drawings used in these tutorials are available in the [tutorial drawings folder](#) (page 819). If you want to save your work from these tutorials, save the drawings to the [My Civil Tutorial Data folder](#) (page 819) so that you do not overwrite the original drawings.

For more information, see the AutoCAD Civil 3D Help topic *Point Clouds*.

Tutorial: Working with Point Clouds



This tutorial demonstrates how to create a AutoCAD Civil 3D point cloud object from imported LiDAR data, modify the object display, and then create a surface from a subset of point cloud points.

For more information, see the AutoCAD Civil 3D Help topic *Understanding Point Cloud Objects*.

Exercise 1: Importing Point Cloud Data

In this exercise, you will import a LiDAR data file to create an AutoCAD Civil 3D point cloud object.



For more information, see the AutoCAD Civil 3D Help topic *Creating Point Cloud Objects*.

- 1 Open *Point Cloud-1.dwg*, which is located in the [tutorial drawings folder](#) (page 819).
- 2 Click Home tab ► Create Ground Data panel   Create Point Cloud.

Specify basic point cloud information

- 1 In the Create Point Cloud dialog box, on the Information page, specify the following parameters:
 - Name: Point Cloud - Tutorial
 - Point Cloud Style: Single Color
 - Point Cloud Layer: V-SITE-SCAN
- 2 Click Next.

Specify the source data

- 1 On the Source Data page, under Source Data, select Create A New Point Cloud Database.
- 2 Under Select A Point Cloud File Format, select LAS.
- 3 Under Files To Be Imported Into The New Point Cloud Database, click .
- 4 In the Select File dialog box, navigate to the [tutorial folder](#) (page 820). Select *Point Cloud.las*. Click Open.
- 5 Under New Point Cloud Database, under Specify New Point Cloud Database, click .
- 6 In the Select File dialog box, navigate to the [My Civil Tutorial Data folder](#) (page 819). For File Name, enter Point Cloud - Tutorial.isd. Click Open.

NOTE The Point Cloud Database Coordinate System and Current Drawing's Coordinate System settings should match. The coordinate system is not set in this tutorial, but the settings come from the following sources:

- Point Cloud Database Coordinate System: This value is taken from the point cloud source file. Click  to change the coordinate system when the data is imported into the point cloud database.
 - Current Drawing's Coordinate System: This value is taken from the Drawing Settings dialog box, on the Units and Zone tab.
-

- 7 Click Next.

Verify the point cloud parameters and create the point cloud object

- 1 On the Summary page, expand the collections in the Property table, and ensure that the properties match what you specified earlier in this exercise. If the property values do not match, use the links on the left side of the dialog box to return to the previous pages.
- 2 Click Finish.
A dialog box notifies you that the point cloud database is being processed in the background, and that you may continue to work in the drawing.
- 3 Click Close.
After a few minutes, a notification appears in the status bar, indicating that the point cloud database has been processed, and the point cloud object has been created.

Examine the point cloud object

- 1 In the status bar notification, click [Click Here To Zoom](#).
The drawing window zooms to the point cloud object.

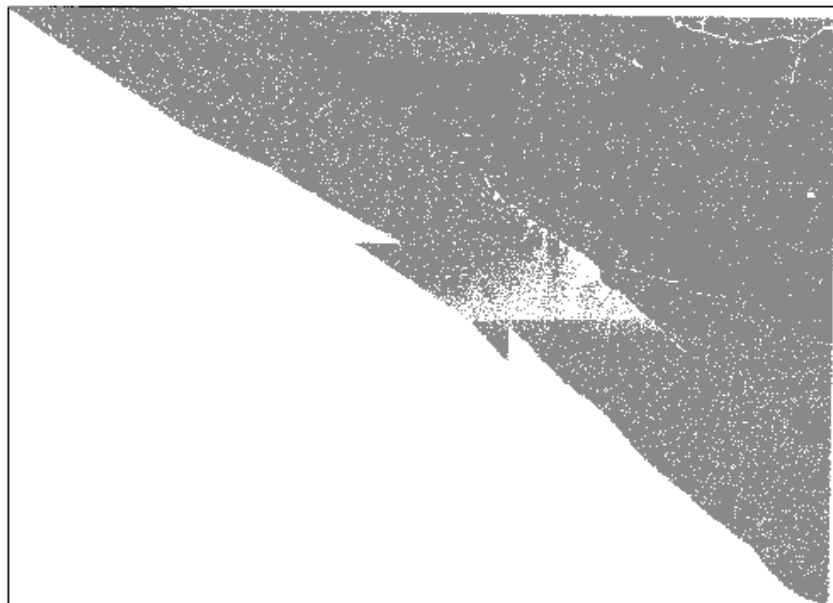

- 2 Zoom in until you can see the points that make up the point cloud.

Examine the points. The point cloud points are stored in the point cloud database, and they cannot be manipulated individually.

3 Zoom to the extents of the point cloud object.

4 Click View tab ► Views panel ►  SE Isometric.

A three-dimensional view of the point cloud object is displayed. The white box that surrounds the point cloud is the bounding box, which identifies the extents of the point cloud object. The size and geometry of the bounding box component depend on the point cloud object minimum and maximum coordinate values. The bounding box serves as a point cloud object proxy when the point cloud source data is not accessible.

5 Click View tab ► Views panel ►  Top.

To continue this tutorial, go to [Exercise 2: Working with Point Cloud Styles](#) (page 50).

Exercise 2: Working with Point Cloud Styles

In this exercise, you will use styles to view the point cloud object in different ways, as well as to filter the display of imported point cloud data.

For more information, see the AutoCAD Civil 3D Help topic *Displaying and Stylizing Point Clouds*.

This exercise continues from [Exercise 1: Importing Point Cloud Data](#) (page 47).

Display point cloud points by elevation

1 In the drawing, select the point cloud.

2 Click Point Cloud tab ► Modify panel ► Point Cloud Properties drop-down ►  Point Cloud Properties.

3 In the Point Cloud Properties dialog box, on the Information tab, under Point Cloud Style, select Elevation Ranges.

This point cloud style displays point cloud points as a specified color, based on their elevation value.

4 On the Elevation Ranges tab, click Reset From Style.

This action specifies that the point cloud style parameters determine the display properties of the point cloud.

5 Click OK.

The point cloud now shows the major differences in elevation between the point cloud points. In the following steps, you will view point cloud points by the classification code that was assigned to them as they were created.

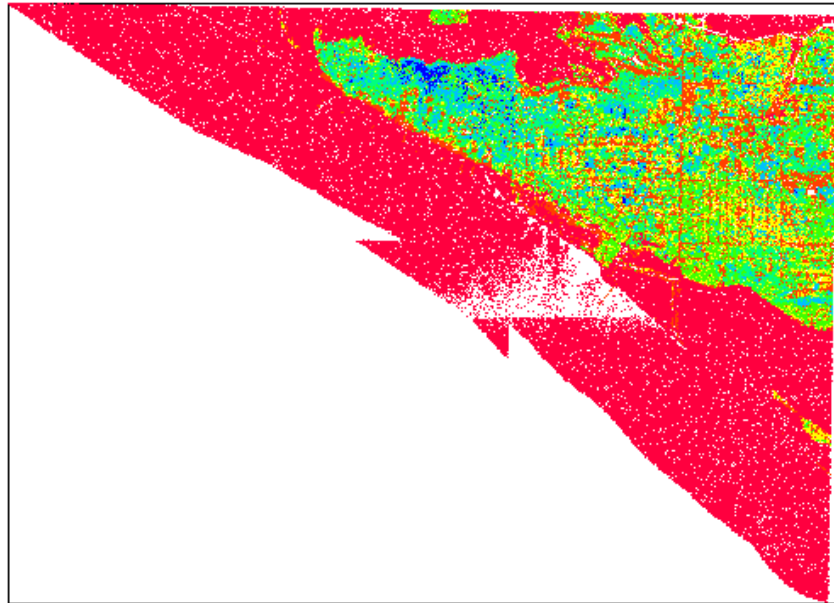



Display point cloud points by classification

- 1** In the drawing, select the point cloud.
- 2** Click Point Cloud tab ► Modify panel ► Point Cloud Properties drop-down ►  Point Cloud Properties.
- 3** In the Point Cloud Properties dialog box, on the Information tab, under Point Cloud Style, select LIDAR Point Classification. Click OK.

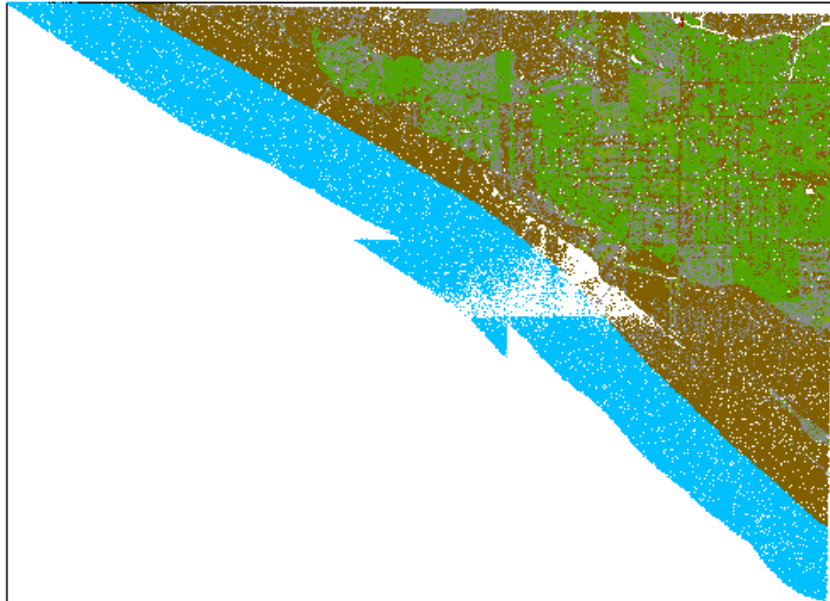
The point cloud now shows the color-coded point cloud points. This is a useful way to see different features that were captured during the scan. In the following steps, you will adjust the point cloud style to filter unwanted features from the point cloud.



Filter points by classification

- 1 In the drawing, select the point cloud.
- 2 Click Point Cloud tab ► Modify panel ► Point Cloud Properties drop-down ►  Edit Point Cloud Style.
- 3 In the Point Cloud Style dialog box, on the Classification tab, click .

For this exercise, you will specify that the style display only the ground points.

NOTE The classifications in this table are based on ASPRS *American Society of Photogrammetry and Remote Sensing* standards.

- 4 In the LIDAR Classification table, select the 2 Ground check box.
As shown in the Color column, the point cloud points that are assigned the 2 classification are displayed as brown.
- 5 Click OK.

In the drawing, only brown, Ground points are displayed. In the next exercise, you will learn how to create a AutoCAD Civil 3D surface from this subset of point cloud points.

NOTE If the display does not change, enter REGEN on the command line.

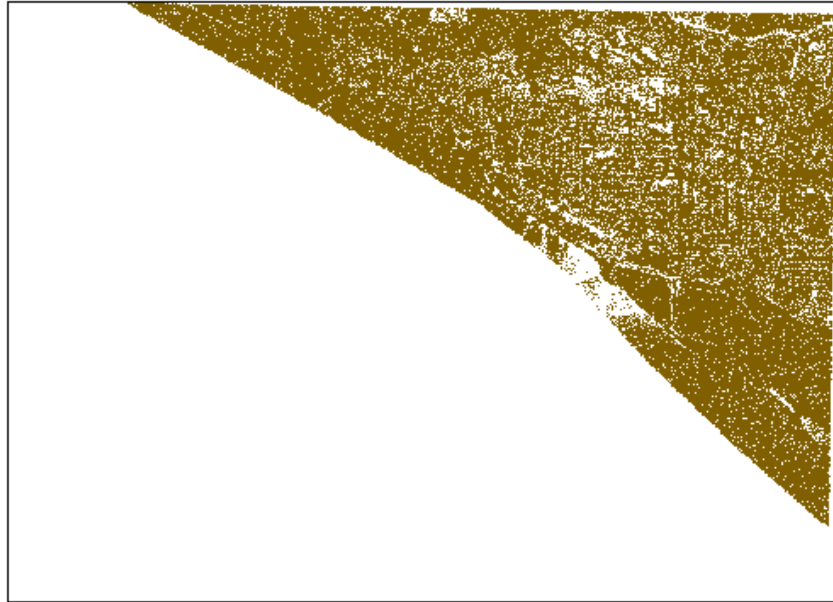

To continue this tutorial, go to [Exercise 3: Adding Point Cloud Data to a Surface](#) (page 53).

Exercise 3: Adding Point Cloud Data to a Surface

In this exercise, you will create a surface from a subset of imported point cloud points, and then examine the relationship between the point cloud and surface objects.

For more information, see the AutoCAD Civil 3D Help topic *Adding Point Cloud Points to Surfaces*.

This exercise continues from [Exercise 2: Working with Point Cloud Styles](#) (page 50).

Adjust the visible point density

- 1 In the drawing, select the point cloud.

On the Point Cloud tab, on the Point Cloud Tools panel, the Point Density slider enables you to adjust the density of points displayed at once for all point clouds in the drawing view. When the slider is set to 100, the drawing will display either 750000 point cloud points, or all the point cloud points that exist in the visible area, whichever is less.

- 2 In the field next to the Point Density slider, enter 10. Press Enter.

The density of the points that are visible in the visible drawing area is reduced.

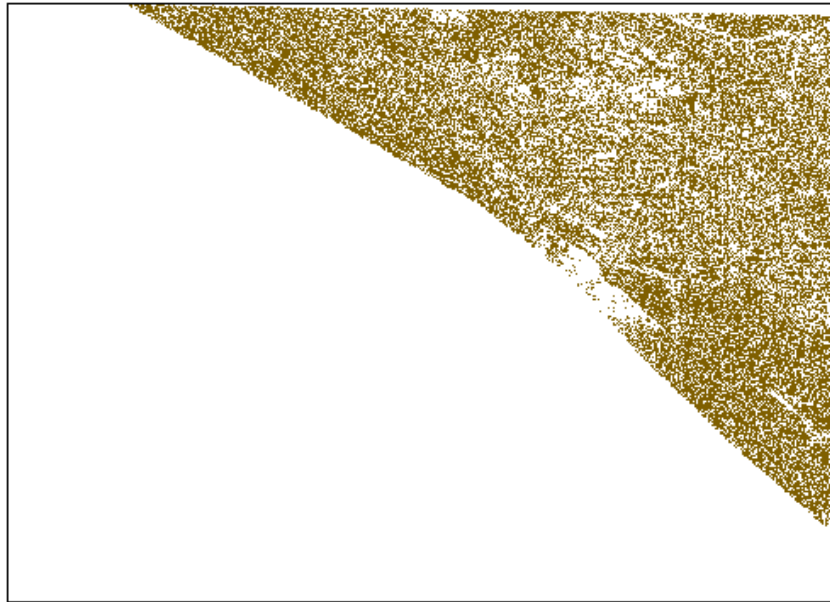

Add point cloud points to a surface

- 1 Click Home tab ► Layers panel ► Layer drop-down. Next to

_TOPO-BOUNDARY, click . Click in the drawing to exit the Layer list. A closed polygon is displayed in the drawing. In the following steps, you will create a surface from the point cloud points that are inside this polygon.

- 2 In the drawing, select the point cloud object.

- 3 Click Point Cloud tab ► Point Cloud Tools panel ►  Add Points to Surface.
- 4 In the Add Points to Surface wizard, on the Surface Options page, specify the following parameters:
 - Name: Point Cloud Surface
 - Surface Style: Contours 0.5' and 2.5' with Points

NOTE You may also add the point cloud points to an existing surface in the current drawing.

- 5 Click Next.
- 6 On the Region Options page, under Specify a Region Option, select Object.
- 7 Click Define Region in Drawing.
- 8 In the drawing, select the polygon.
- 9 Click Next.
- 10 On the Summary page, expand the collections in the Property table, and ensure that the properties match what you specified earlier in this exercise. If the property values do not match, use the links on the left side of the dialog box to return to the previous pages.
- 11 Click Finish.

The gray surface contours and cyan surface points are displayed in the drawing, and a surface object is displayed in Toolspace on the Prospector tab.

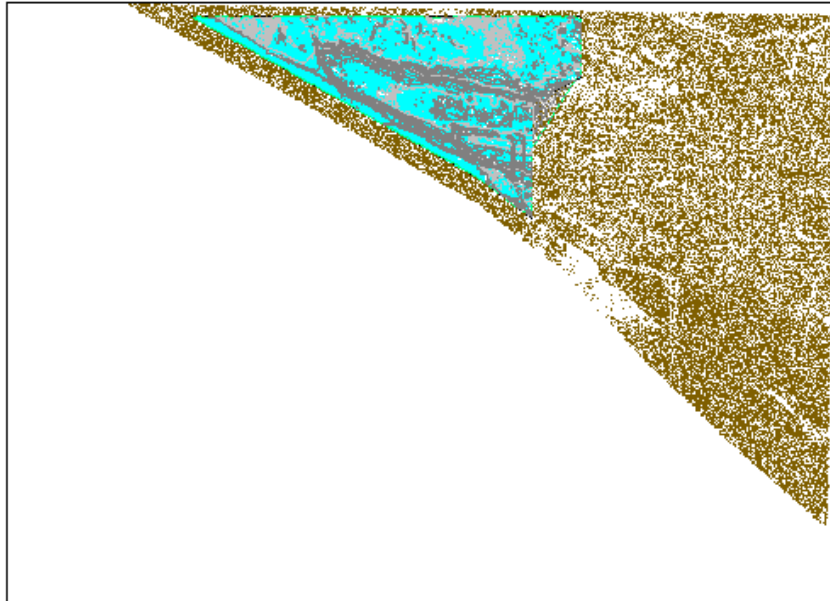

Modify the surface

- 1 Press Esc to deselect the point cloud object.
- 2 In Toolspace, on the Prospector tab, expand the Surfaces collection. Right-click Point Cloud Surface. Click Rebuild - Automatic.
- 3 Zoom in to the surface.

NOTE As you zoom in, AutoCAD Civil 3D honors the point cloud density setting by displaying more point cloud points.

- 4 Select the surface.
- 5 Click TIN Surface tab ► Modify panel ► Edit Surface drop-down ►  Delete Point.
- 6 On the command line, enter C to use crossing selection.
- 7 Draw a window around a group of cyan points. Press Enter.
The cyan surface points are removed, and the contours update. The brown point cloud points are still present because they are stored in the point cloud database, and are not affected by edits to the surface.

- 8 Press Enter to end the command.
- 9 In the drawing, select the polygon that you used to create the surface.
- 10 Select one of the grips, and drag it to a new location. Click to place the grip.
The surface updates to include the point cloud data that is enclosed in the new area.

Further exploration: On the right-hand side of the surface, the surface contours extend beyond the extents of the polygon. The surface triangulated outside that side of the surface. You may use the polygon as an outer boundary to prevent triangulation outside the surface extents. For more information, see the [Adding an Outer Boundary to a Surface](#) (page 70) exercise.

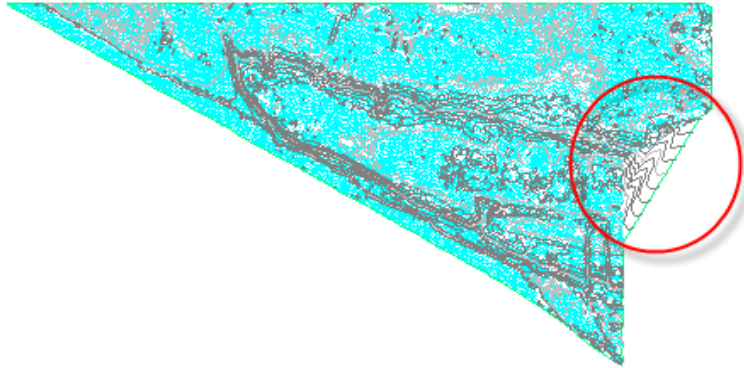

Surfaces Tutorials

5

These tutorials will get you started working with land surfaces. A surface is a central object for AutoCAD Civil 3D, and can be referenced by alignments, parcels, and other objects throughout the design process.

NOTE All drawings used in these tutorials are available in the [tutorial drawings folder](#) (page 819). If you want to save your work from these tutorials, save the drawings to the [My Civil Tutorial Data folder](#) (page 819) so that you do not overwrite the original drawings.

For more information, see the AutoCAD Civil 3D Help topic *Understanding Surfaces*.

Tutorial: Creating and Adding Data to a Surface

This tutorial demonstrates how to create a TIN surface, and then add contour, breakline, and boundary data to the surface.

When you create a surface, its name is displayed in the Surfaces collection in Toolspace on the Prospector tab. From this location, you can perform other operations, such as adding data and editing the surface. When first created, the surface is empty, so it is not visible in the drawing.

After data has been added to a surface, it becomes visible in the drawing in accordance with the display settings specified in the referenced surface style.

TIN Surfaces

A TIN surface is composed of the triangles that form a triangulated irregular network. A TIN line is one of the lines that makes up the surface triangulation.

To create TIN lines, AutoCAD Civil 3D connects the surface points that are closest together. The TIN lines form triangles. The elevation of any point in the surface is defined by interpolating the elevations of the vertices of the triangles that the point lies in.

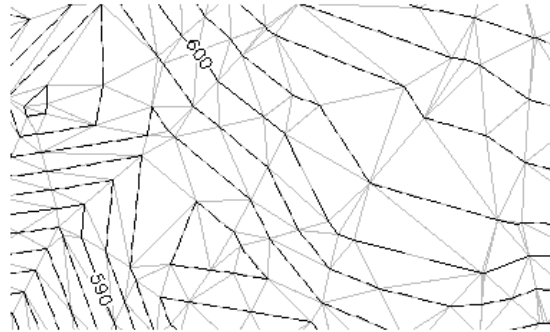

Contour Data

Contours are graphical illustrations of surface elevation changes. You can create a surface from contours drawn as simple 3D polylines, which have x, y, and z coordinate data.

Boundaries

Boundaries are closed polylines that affect the visibility of the triangles either inside or outside the polylines. An outer boundary defines the extents of the surface. All triangles inside the boundary are visible, and all triangles that are outside the boundary are invisible.

Areas hidden by boundaries are not included in calculations, such as total area and volume.

Surface boundaries are defined by selecting existing polygons in the drawing. The surface definition displays the numerical ID and a list of vertices for each boundary.

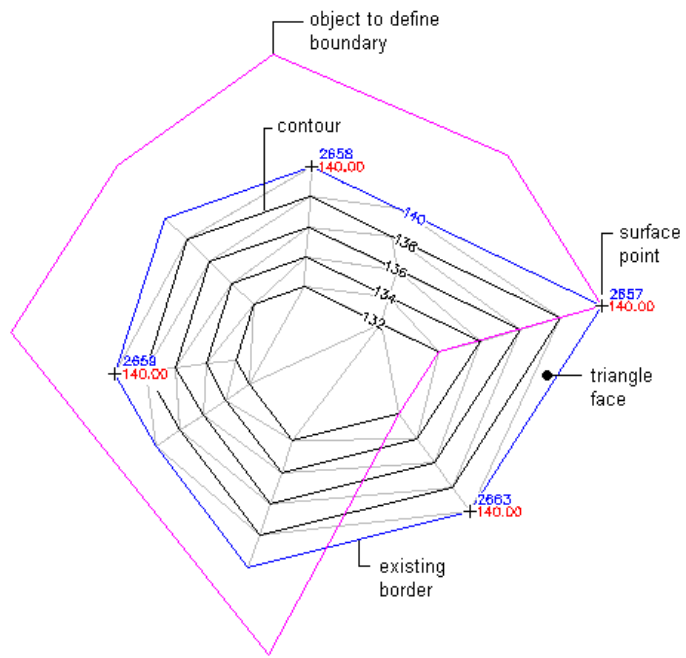

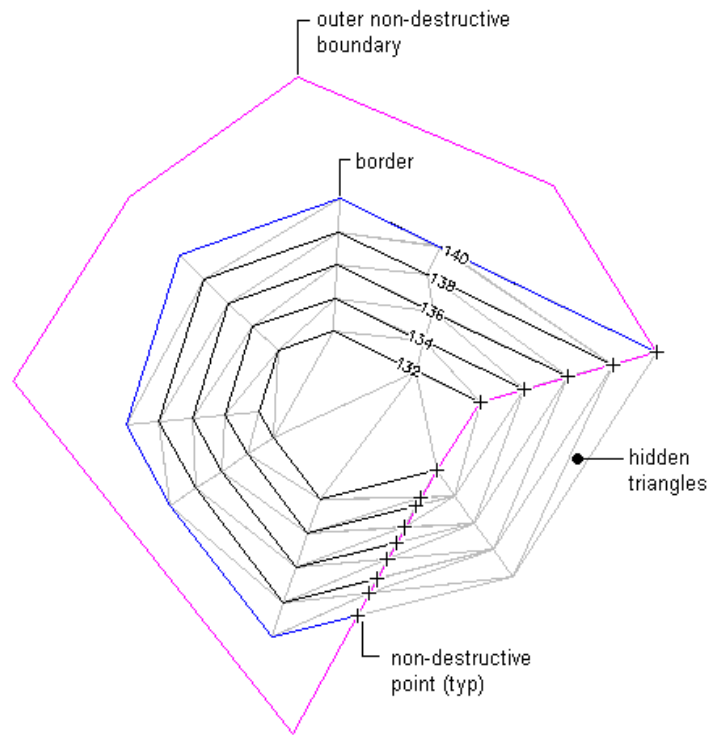

Breaklines

Breaklines define linear surface features, such as retaining walls, curbs, tops of ridges, and streams. Breaklines force surface triangulation to run along the breakline; triangles do not cross a breakline.

Breaklines are critical to creating an accurate surface model. Breaklines are important because it is the interpolation of the data, not just the data itself, that determines the shape of the model.

You can use 3D lines or 3D polylines as breaklines. Each vertex on the polyline is converted to a TIN point with the same XYZ coordinates. For 3D lines, each line that you select is defined as a two-point breakline.

For more information, see the AutoCAD Civil 3D Help topics *Creating Surfaces* and *Adding and Editing Surface Data*.



Exercise 1: Creating a TIN Surface

In this exercise, you will create an empty TIN surface in a new drawing.

For more information, see the AutoCAD Civil 3D Help topic *Creating a TIN Surface*.

Create a TIN surface in a new drawing



- 1 Click  ► New.
- 2 In the Select Template dialog box, browse to the [tutorial folder](#) (page 820). Select *Surface.dwt*. Click Open.
- 3 Click Home tab ► Create Ground Data panel ► Surfaces drop-down ► Create Surface .
- 4 In the Create Surface dialog box, for Type, select **TIN surface**.

NOTE By default, a new Surface Layer will be created named C-TOPO- followed by the name you enter in the Name cell. You can also click  to specify an existing layer for the surface.

- 5 In the Properties table, specify the following parameters:
 - Name: EG
 - Description: Existing Ground surface from imported point data
 - Style: Points and Border

TIP To select the style, click the Value cell, and then click  to display the Select Surface Style dialog box.

- Render Material: **ByLayer**
- 6 Click OK.
 - 7 In Toolspace, on the Prospector tab, expand the Surfaces collection.

The new surface name is displayed in the  Surfaces collection in Toolspace on the Prospector tab, but this surface does not contain any data.

To continue this tutorial, go to [Exercise 2: Adding Point Data to a Surface](#) (page 64).

Exercise 2: Adding Point Data to a Surface

In this exercise, you will import point data from a text file into the current drawing.



For more information, see the AutoCAD Civil 3D Help topic *Contours*.

This exercise continues from [Exercise 1: Creating a TIN Surface](#) (page 63).

Import point data into the current drawing

- 1 Open drawing *Surface-1A.dwg*, which is available in the [tutorial drawings folder](#) (page 819).

This drawing contains an empty surface definition, which is named EG.

- 2 Click Modify tab ► Ground Data panel ►  Surface.
- 3 Click Surface tab ► Modify panel ►  Add Data ►  Point Files.
- 4 In the Add Point File dialog box, under Format, select PENZD (Space Delimited).

- 5 Under Source File, click  .
- 6 In the Select Source File dialog box, browse to the [tutorial folder](#) (page 820). Select *EG-Surface-PENZD (space delimited).txt*. Click Open.
- 7 In the Add Point File dialog box, click OK.
- 8 At the command line, enter ZE.
The surface, which contains the imported point data, is displayed in the drawing.

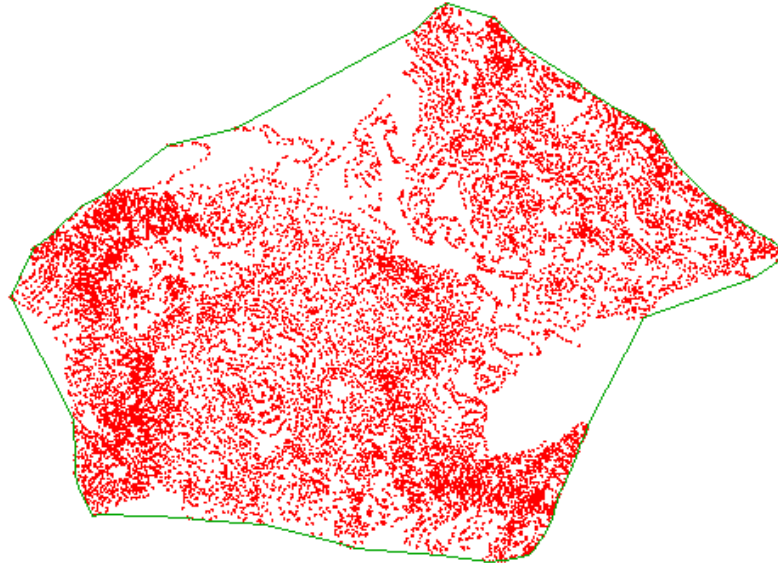

To continue this tutorial, go to [Exercise 3: Adding Breaklines to a Surface](#) (page 65).

Exercise 3: Adding Breaklines to a Surface

In this exercise, you will cause the surface to triangulate along a linear feature.

Breaklines are used to define surface features and to force triangulation along the breakline. Surfaces do not triangulate across breaklines, creating more accurate TIN surface models.

In this exercise, you will create breaklines along the edge of pavement for an existing road. Breaking the surface along features produces a more accurate surface rendering.

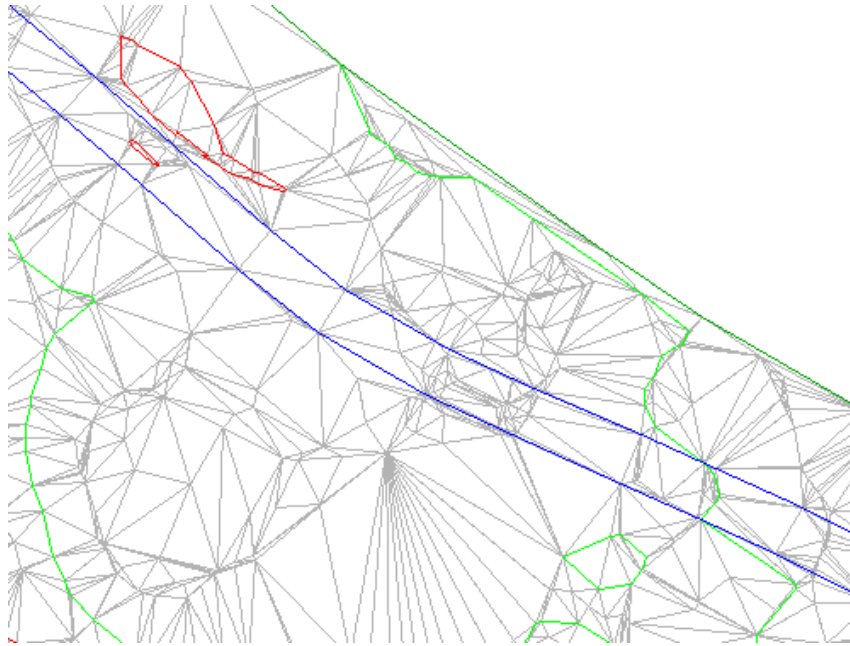

For more information, see the AutoCAD Civil 3D Help topic *Breaklines*.

This exercise continues from [Exercise 2: Adding Point Data to a Surface](#) (page 64).

Display the source polylines and change the surface style

NOTE This exercise uses the drawing you created in the previous exercises, or you can open *Surface-1B.dwg* from the [tutorial drawings folder](#) (page 819).

- 1 Click Home tab ► Layers panel ► Layer drop-down. Next to the `_EG_BREAKLINES` layer, click .

The 3D polylines that represent the edge of pavement (EP) of an existing road are displayed on the east side of the site.



NOTE The EP polylines were included in the drawing template you used in [Exercise 1: Creating a TIN Surface](#) (page 63).

- 2 Select the surface. Right-click. Click Surface Properties.
- 3 In the Surface Properties dialog box, on the Information tab, for Surface Style, select **Contours and Triangles**. Click OK.

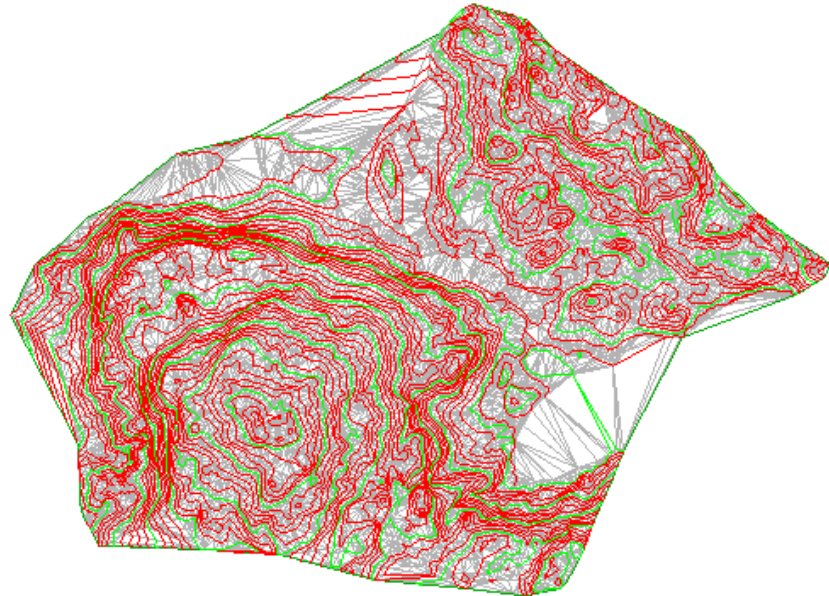
The surface now shows contours and triangles that illustrate the EG surface triangulation.



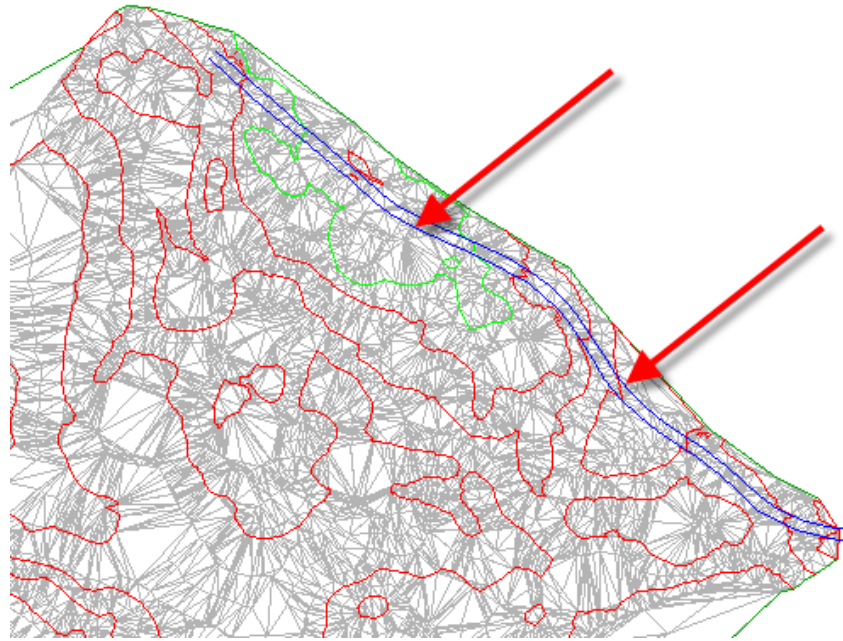

Create breaklines from the polylines

- 1 In Toolspace, on the Prospector tab, expand the  Surfaces ► EG ►  Definition collections. Right-click  Breaklines. Click Add.
- 2 In the Add Breaklines dialog box, for Description, enter Edge of pavement - existing road. Use the default values for the other fields. Click OK.
- 3 The Select Objects prompt becomes active. While in this command, use the Zoom and Pan commands to locate the two blue 3D polylines on the east side of the site.
Zoom in close so you can see that the triangles cross over the polylines.

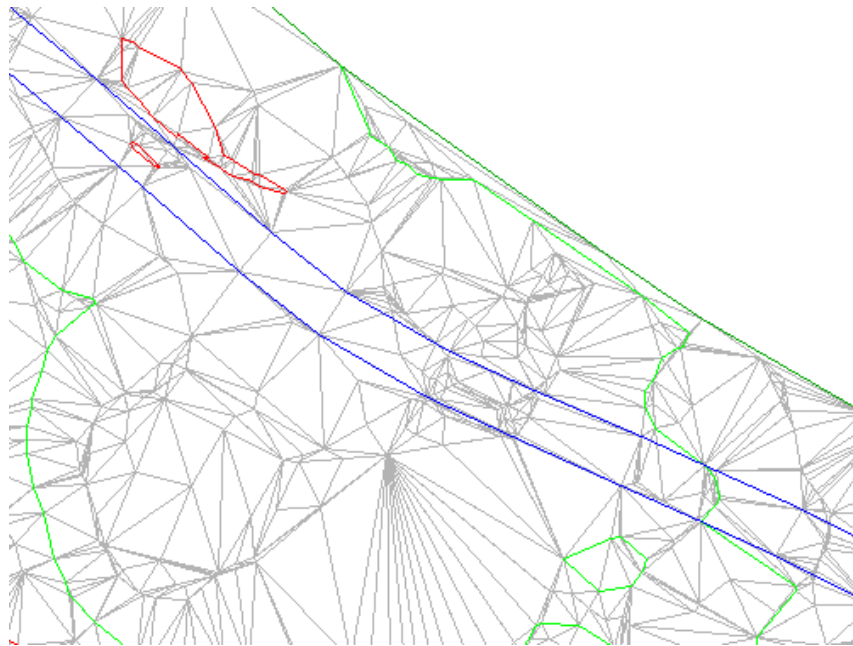

- 4 Select the polylines. Press Enter.
The surface triangulation is modified. The edge of pavement breaklines are applied, and the TIN surface is adjusted along the breakline edges, modifying the surface triangulation.



- 5 Click Home tab ► View panel ► views drop-down ► Extents.
The drawing window zooms to the extents of the surface. With the breakline data added, the layer that contained the source data for the breaklines can be frozen.
- 6 Click Home tab ► Layers panel ► Layer drop-down. Next to the **EG_BREAKLINES** layer, click .

Further exploration: Notice that, along some portions of the polylines, the surface triangulation incorrectly crosses the breakline. This happened because the surface contours also act as breaklines. The new breaklines are not added because the contours are already acting as breaklines, and the current surface setting does not allow more than one breakline to affect the surface at a given point. To override this behavior, you can perform any of the following tasks:

- **Build the surface with contours and breaklines:** In the Surface Properties dialog box, on the Definition tab, expand the Build collection. Set Allow Crossing Breaklines to Yes, and then set Elevation to Use to Use Last Breakline Elevation at Intersection.

- **Modify the surface:** Use the DeleteSurfacePoint command to delete surface points that are located exactly on the polylines.
- **Modify the polylines:** Add a vertex to the polylines at each location where it crosses a surface contour.

To continue this tutorial, go to [Exercise 4: Adding an Outer Boundary to a Surface](#) (page 70).

Exercise 4: Adding an Outer Boundary to a Surface

In this exercise, you will insert a polyline from an external DWG file and create an outer surface boundary from the polyline.

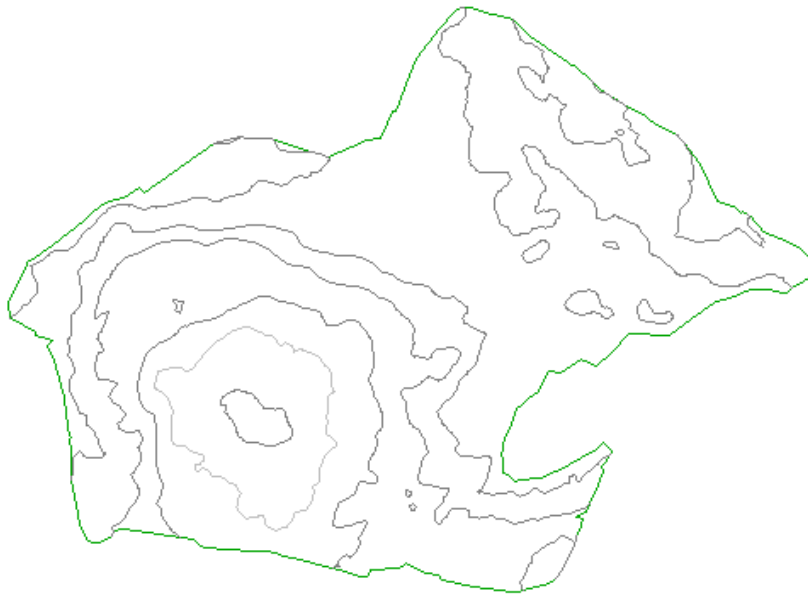





For more information, see the AutoCAD Civil 3D Help topic *Boundaries*.

This exercise continues from [Exercise 3: Adding Breaklines to a Surface](#) (page 65).

Create an outer boundary from a polyline

NOTE This exercise uses *Surface-1B.dwg* with the modifications you made in the previous exercise.

- 1 Click Home tab ► Layers panel ► Layer drop-down. Next to the **_EG-BNDY** layer, click . Click in the drawing to exit the Layer Control list.
A blue polyline, which represents the extents of the site, is displayed. This polyline was imported with the original surface contours.
- 2 In Toolspace, on the Prospector tab, expand the  Surfaces ►  **EG** ►  Definition collections. Right-click  Boundaries. Click Add.
- 3 In the Add Boundaries dialog box, specify the following parameters:
 - Name: EG - Outer
 - Type: Outer
 - Non-Destructive Breakline: Cleared
 - Mid-Ordinate Distance: 1.000
- 4 Click OK.
- 5 Select the blue polyline.

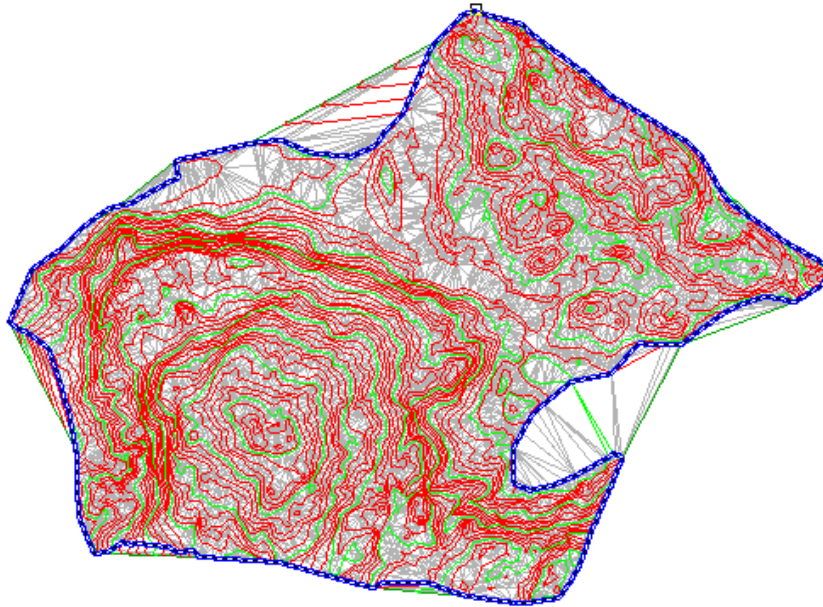

The boundary is added to the surface definition, and the surface display in the drawing is clipped to the area that is defined by the new outer boundary.

Hide the polyline and change the surface style

- 1 Click Home tab ► Layers panel ► Layer drop-down. Next to the **_EG-BNDY** layer, click .
- 2 Select the surface. Right-click. Click Surface Properties.
- 3 In the Surface Properties dialog box, on the Information tab, for Surface Style, select **Contours 5' and 25' (Background)**. Click OK.
In the selected surface style, contours are displayed in muted colors at broad intervals. This display allows the major surface features to remain visible while you focus on other aspects of the site design.

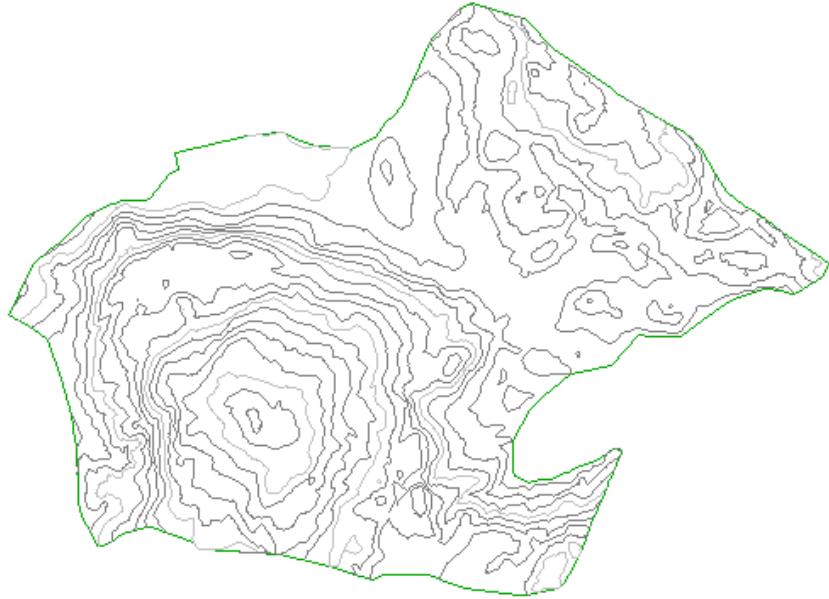

To continue to the next tutorial, go to [Working with Large Surfaces](#) (page 73).

Tutorial: Working with Large Surfaces

This tutorial demonstrates several features that can help you manage large surfaces efficiently in AutoCAD Civil 3D.

Because surfaces can contain large amounts of data, it is important to use only as much data as is necessary for the current task. For example, when building a surface from LIDAR data, the corresponding point file can contain millions of points. If all of those points are included in the surface definition, it can take a considerable amount of time to rebuild the surface. If you restrict the points that the surface uses to a given area, the surface rebuilds faster and the drawing size is smaller.

The exercises in this tutorial demonstrate how to insert a relatively dense LIDAR point file into a surface, but restrict the amount of data that is actually used.

For more information, see the AutoCAD Civil 3D Help topic *Adding and Editing Surface Data*.

Exercise 1: Limiting Imported Surface Data

In this exercise, you will use a data clip boundary to restrict the quantity of points that is referenced by a surface.

Points that are in the point file, but outside the specified data clip boundary, will be ignored when the surface is built and during any subsequent surface editing operations.

For more information, see the AutoCAD Civil 3D Help topic *Boundaries*.

Add a data clip boundary to a surface

- 1 Open *Surface-2.dwg*, which is located in the [tutorial drawings folder](#) (page 819).
- 2 In Toolspace, on the Prospector tab, expand the Surfaces collection. Expand the EG surface.
The EG surface is currently empty. In the following steps, you will use the red polyline in the drawing to create a *Data Clip* boundary, which will restrict imported surface data to the extents of the boundary. Then, you will import a relatively dense LIDAR point file and examine the results.
- 3 Expand the EG surface ► Definition collection. Right-click Boundaries. Click Add.
- 4 In the Add Boundaries dialog box, specify the following parameters:
 - Name: Site
 - Type: Data Clip
 - Mid-Ordinate Distance: 1.000'
- 5 Click OK.
- 6 In the drawing window, click the red polyline.
The polyline is added to the EG surface definition as a boundary. The presence of a boundary in the surface definition is indicated by the  marker next to the Boundaries item on the Prospector tab. When the Boundaries collection is selected, the boundaries that have been added to the surface appear in the Prospector list view.
In the following steps, you will add a relatively dense LIDAR point file to the surface definition. The point file will be added only within the extents of the data clip boundary that you just added.

Import surface data from a point file

- 1 Expand the EG surface ► Definition collection. Right-click Point Files. Click Add.
- 2 In the Add Point File dialog box, in the Format list, select ENZ (Comma Delimited).
- 3 Click  at the end of the Source File(s) field.
- 4 In the Select Source File dialog box, ensure that the Files Of Type field is set to (*.csv).
- 5 Navigate to the [tutorial folder](#) (page 820). Select *LIDAR_ENZ (comma delimited).csv*. Click Open.
- 6 In the Add Point File dialog box, clear both the Do Elevation Adjustment If Possible and Do Coordinate Transformation If Possible check boxes. Click OK.

The point data is added to the drawing.

A reference to the point file is added to the EG surface definition. The presence of point data in the surface definition is indicated by the  marker next to the Point Files item on the Prospector tab.

- 7 Zoom in to the lower right corner of the surface.
Notice that only points that are inside the data clip boundary have been imported, and that a green border was created from the imported data.
The border is outside the red data clip boundary in some areas, and inside the data clip boundary in other areas. This happened because points in the point file that are outside the data clip boundary were excluded during the import operation. The green border is formed by the points at the outermost extents of the points that were imported.

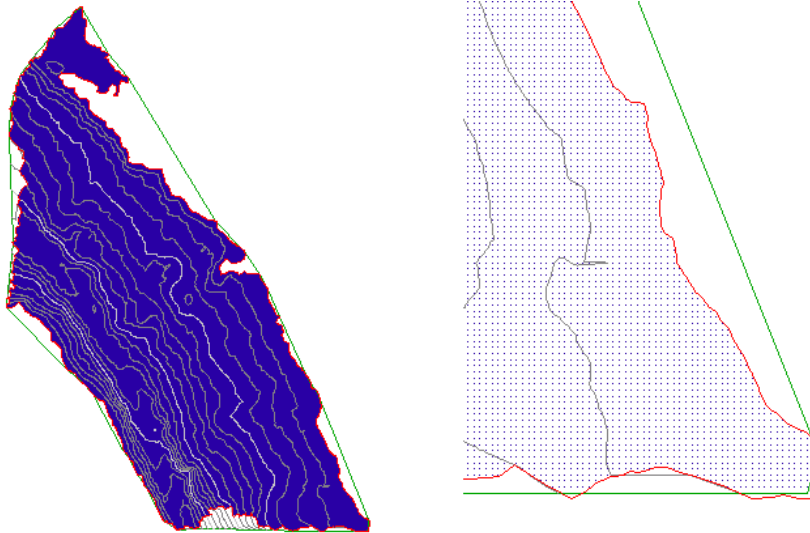

Surface with points imported within a data clip boundary (left) and detail of the surface (right)



- 8 On the command line, enter ZE to zoom to the extents of the drawing.

Restrict the surface data to a smaller area

- 1 Click Home tab ► Layers panel ► Layer drop-down. Next to the C-TOPO-BNDY-CORR layer, click  .
This layer contains an orange polyline that you will use to create a second data clip boundary.
- 2 Expand the EG surface ► Definition collection. Right-click Boundaries. Click Add.
- 3 In the Add Boundaries dialog box, specify the following parameters:
 - Name: Corridor
 - Type: Data Clip
 - Mid-Ordinate Distance: 1.000'
- 4 Click OK.
- 5 In the drawing window, click the orange polyline.

The polyline is added to the EG surface definition as a boundary, but the point data did not change. Data clip boundaries only affect surface editing operations that are performed after the data clip boundary has been added. Because the points were added to the surface before the Corridor boundary, the boundary currently does not affect the point data.

In the following steps, you will rearrange the surface definition operations so that the points will be restricted to the extents of the new Corridor data clip boundary.

- 6** In Toolspace, on the Prospector tab, right-click the EG surface. Click Surface Properties.
- 7** In the Surface Properties dialog box, on the Definition tab, in the Operation Type column, examine the order of the operations.
The operations you performed in this exercise are listed in the order in which they were performed. The Site data clip boundary was added first, and it affects the operations that follow it. The Corridor data clip boundary was added last, so it currently does not affect any other operations.
- 8** Select the last Add Boundary operation in the list. Click  to move the Add Boundary operation to the top of the list.
- 9** Select the other Add Boundary operation. Click  to move the Add Boundary operation to the bottom of the list.
- 10** Click Apply.
- 11** In the Surface Properties - Rebuild Surface dialog box, click Rebuild the Surface.
When the surface rebuilds, the points outside the orange Corridor data clip boundary are excluded from the surface.

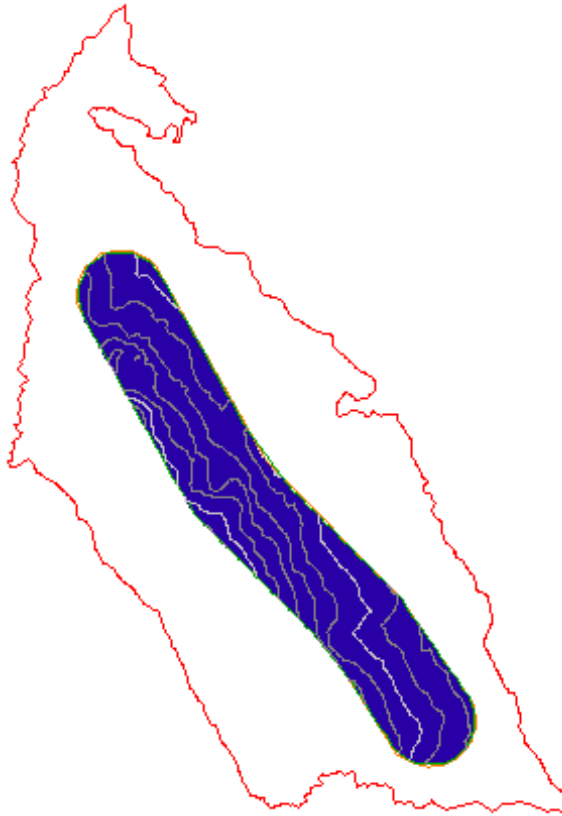

Surface with Corridor data clip boundary applied

Further exploration: Rearrange the surface definition operations and observe the results. Before you continue to the next exercise, make sure that the Operation Type table is in the following order:

- Add Boundary: Corridor
- Import Point File
- Add Boundary: Site

To continue this tutorial, go to [Exercise 2: Simplifying a Surface](#) (page 79).

Exercise 2: Simplifying a Surface

In this exercise, you will reduce the number of points that are used to define a surface.

A surface can be simplified by removing either TIN edges or points. When the simplify surface command is complete, new points and TIN edges are calculated based on specified parameters. The original surface points are still contained in the referenced point file, but are not used in the surface triangulation.

In this exercise, you will use the Point Removal method of simplifying a surface. This method randomly selects points from the surface, and removes them based on the point density at different areas of the surface. More points are removed from areas in which the concentration of points is very dense than from areas that contain fewer points.

NOTE You cannot specify which points to remove. Points that are used to define surface borders and breaklines are not removed with the Simplify Surface command.

For more information, see the AutoCAD Civil 3D Help topic *Simplifying Surfaces*.

This exercise continues from [Exercise 1: Limiting Imported Surface Data](#) (page 74).

Simplify a surface

NOTE This exercise uses *Surface-2.dwg* with the modifications you made in the previous exercise.

- 1 Click Home tab ► Layers panel ► Layer drop-down. Next to the C-TOPO-CONT-MAJR-ORIG and C-TOPO-CONT-MINR-ORIG layers, click



These layers contains polylines that represent the original major and minor contours. These polylines will enable you to observe the results of the Simplify Surface command.

- 2 Click Modify tab ► Ground Data panel ► Surface.
- 3 Click Surface tab ► Modify panel ► Edit Surface drop-down ► Simplify Surface .
- 4 In the Simplify Surface wizard, on the Simplify Methods page, select the Point Removal option.
- 5 Click Next.

- 6 On the Region Options page, specify the following parameters:
 - Select Objects: Selected
 - Mid-Ordinate Distance: 1.000'
- 7 Click Pick In Drawing.
- 8 In the drawing, click the orange corridor boundary.
In the Simplify Surface wizard, notice the value for Total Points Selected In Region. This is the current number of points in the selected region.
- 9 Click Next.
- 10 On the Reduction Options page, specify the following parameters:
 - Percentage Of Points To Remove: Selected, 50%
 - Maximum Change In Elevation: Cleared
- 11 Click Apply.
At the bottom of the wizard, notice the Total Points Removed value. This value is the number of points that the simplify surface command removed within the selected boundary.

NOTE You can click Apply again to repeat the Simplify Surface command and keep the wizard open. If you click Finish, the Simplify Surface command is repeated and the wizard is closed.

- 12 Click Cancel.
- 13 Zoom in to the surface.
Notice that the points are not as dense as they were at the beginning of the exercise, and the new, gray surface contours are very similar to the original contours. The Simplify Surface command reduced the amount of data that the surface uses without sacrificing much surface accuracy.

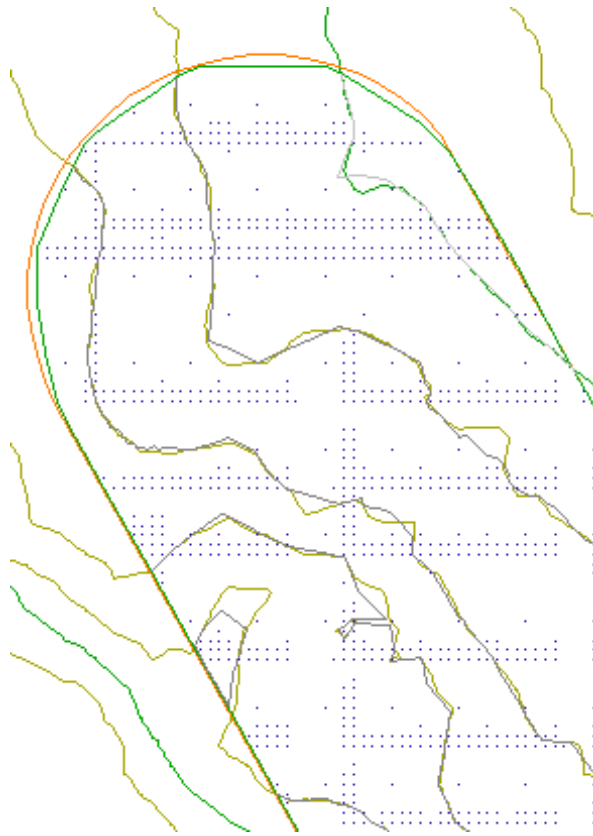

Simplified surface

To continue to the next tutorial, go to [Changing the Surface Style and Display](#) (page 81).

Tutorial: Changing the Surface Style and Display

This tutorial demonstrates how to change and constrain the surface styles and display.

Using styles is an efficient way to control surface display. Rather than answering prompts for numerous variables every time you create a surface, you can reference a predefined style that sets all the variables as required.

Surface styles are managed the way all object styles are managed in AutoCAD Civil 3D, by using the Toolspace Settings tree. All objects have a standard object style grouping on the Settings tree, called an object style collection. You can create, edit, copy, and delete the styles for an object.

Surface styles define how the surface components are displayed in the drawing. If you want to change the appearance of a component, either apply a different style or edit the style.

The surface styles contain the following component parameters and component display settings for the creation of surface data objects:

- Borders — Interior and exterior border and datum display
- Contours — Minor, major, depression, and user-defined contour lines display
- Grid — Primary and secondary grid display
- Points — All surface points for the TIN or Grid surfaces
- Triangles — TIN face information
- Watersheds — Watershed analysis display
- Analysis — Directions, elevations, slopes, and slope arrows

For more information, see the AutoCAD Civil 3D Help topic *Surface Styles and Display*.

Exercise 1: Editing the Surface Style



In this exercise, you will hide the display of the points on the surface and turn on the display of depression contours.

Depression contours form closed loops around areas of descending elevation. These are areas where lakes or ponds can form if the rainfall and soil conditions are right.

For more information, see the AutoCAD Civil 3D Help topic *Surface Styles and Visualization*.

Edit the surface style

- 1 Open *Surface-3.dwg*, which is located in the [tutorial drawings folder](#) (page 819).

- 2 In Toolspace, on the Settings tab, expand the Surface ► Surface Styles collection.
This collection contains the existing surface styles in the drawing.
- 3 The style (Standard) that is being referenced by a surface in the drawing is designated with an orange marker: 
- 4 Right-click the Standard surface style. Click Edit.
- 5 In the Surface Style dialog box, click the Display tab.
- 6 In the Component Display table, turn off the visibility of Points in the surface. To do this, click  in the Visible column. Click Apply.
- 7 Click the Contours tab.
- 8 Expand the Contour Depressions property group. Specify the following parameters:
 - Display Depression Contours: True
 - Tick Mark Length: 5
- 9 Click OK.
- 10 Depression contours are now visible in the drawing, with tick marks along their length.

To continue this tutorial, go to [Exercise 2: Using a Different Style for a Surface](#) (page 83).

Exercise 2: Using a Different Style for a Surface

In this exercise, you will change the surface style, which the surface is referencing, to display different views of the surface.

For more information, see the AutoCAD Civil 3D Help topic *Surface Styles and Visualization*.

This exercise continues from [Exercise 1: Editing the Surface Style](#) (page 82).

Change the surface style

NOTE This exercise uses *Surface-3.dwg* with the modifications you made in the previous exercise.

- 1 In Toolspace, on the Prospector tab, expand the Surfaces collection. Right-click the XGND surface. Click Surface Properties.
- 2 In the Surface Properties dialog box, on the Information tab, in the Surface Style list, select Border & Triangles & Points.
This style is set to display the borders and the TIN faces with 3x vertical exaggeration. These display settings make it easier to see the vertical relief of the surface.
- 3 Click OK.
The surface representation updates to display the TIN triangles and border.
- 4 Click View tab ► Navigate panel ► Orbit drop-down ► Free Orbit.
- 5 Using the Free Orbit tool, rotate the surface in the drawing to display the exaggerated elevations. These elevations are most evident along the bottom of the surface where a prominent ridge appears.
- 6 To return to the regular plan view of the surface, click View tab ► Views panel ► Views drop-down ► Top.
- 7 Follow steps 1 to 3 to return the surface style to Standard.

To continue this tutorial, go to [Exercise 3: Labeling a Surface](#) (page 84).

Exercise 3: Labeling a Surface

In this exercise, you will add labels across surface contours. You will place individual labels manually and a series of labels automatically, using AutoCAD polylines as a guide.

For more information, see the AutoCAD Civil 3D Help topic *Adding Surface Labels*.

This exercise continues from [Exercise 2: Using a Different Style for a Surface](#) (page 83).

Draw a polyline to use as a guide

NOTE This exercise uses *Surface-3.dwg* with the modifications you made in the previous exercise.

- 1 Click View tab ► Views panel ► views list ► Surface Labels.
- 2 On the command line, enter PLine.
- 3 When prompted for a start point, click in the green circle in the upper left corner of the view.
- 4 Click in the middle circle, then the lower right circle. Press Enter to end the PLine command.

Label surface contours along the polyline

- 1 Click Annotate tab ► Labels & Tables panel ► Add Labels menu ► Surface ► Add Surface Labels .
- 2 In the Add Labels dialog box, set the Label Type to Contour - Multiple. Leave the other settings at their defaults. Click Add.
- 3 On the command line, enter O to specify that you will select an object to use as a guide.
- 4 On the command line, enter Y to delete the polyline after the labels have been created.
- 5 In the drawing window, select the polyline. Press Enter to end the selection command.

The labels are created along the path you specified with the polyline. This method of surface labeling is useful when you want to lay out the path of surface contour labels before you create the labels. If you wanted to create the path and labels simultaneously without first drawing a polyline, you would click Annotate tab ► Labels & Tables panel ► Add Labels menu ► Surface ► Contour - Multiple , then draw the path.

- 6 In the drawing window, click the line on which the surface labels were drawn. Grips appear on the line.
- 7 Select the grip in the circle at the upper left. It turns red, indicating that it is active.
- 8 Drag the grip to a new location and click. Notice that the labels update automatically to reflect their new position.

Add spot elevation labels

- 1 In the Add Labels dialog box, specify the following parameters:
 - Label Type: Spot Elevation
 - Spot Elevation Label Style: Standard
- 2 Click Add. When prompted, click a point along the ridge to place a label.
- 3 In the Add Labels dialog box, set the Spot Elevation Label Style to Foot Meter.
- 4 Click Add. When prompted, click a point along the ridge to place a label. Using the Add Labels dialog box, you can change label properties as needed while you create surface labels.
- 5 Click Close.

To continue to the next tutorial, go to [Editing Surface Data](#) (page 86).

Tutorial: Editing Surface Data

This tutorial demonstrates some common surface editing tasks, including edge swapping, TIN line deletion, and surface smoothing. You will also hide part of the surface using a hide boundary.

For more information, see the AutoCAD Civil 3D Help topic *Surface Editing Operations*.

Edge Swapping

Edge swapping is used to change the direction of two triangle faces in the surface, to create a more accurate surface model. For example, edges can be swapped to match the triangle edges to ridges or swales.

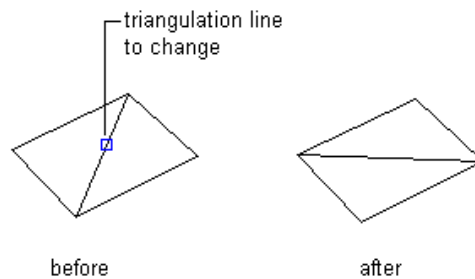

Deleting TIN Lines

Deleting TIN lines may be required, for example, if the surface has TIN triangles on the perimeter that are long and narrow. In this case, the triangles might not be accurate for the surface, and should be deleted.

Surface TIN or Grid lines can also be deleted within a pond, for example, to create a void area. By removing these lines, you can prevent contours from being drawn through the void areas.

When an edge is removed, either an interior border that follows the adjacent lines is created, or the exterior border is modified to follow the new lines.

Hide Boundaries

Hide boundaries mask areas of the surface so triangulation, and therefore contours, are not visible in the area. Use hide boundaries to create holes in a surface, for example, to mark a building footprint.

before

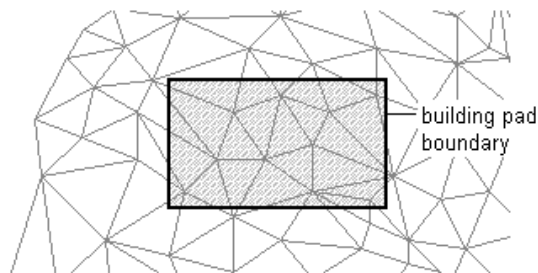

after

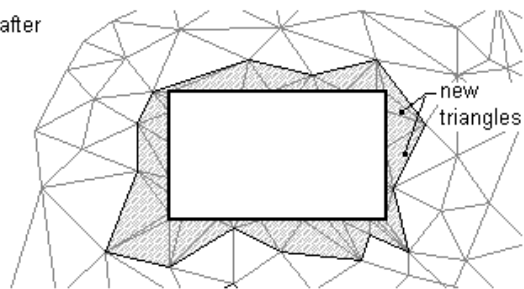

NOTE When you use a hide boundary, the surface is not deleted. The full surface remains intact. If there are surface TIN lines that you want to permanently remove from the surface, use the Delete Line command.

Surface Smoothing

Surface smoothing is an operation that adds points at system-determined elevations using Natural Neighbor Interpolation (NNI) or Kriging methods. The result is smoothed contours, with no overlap.

You perform smoothing as an edit operation on a surface. You can specify smoothing properties and then turn them on or off. When the smoothing is turned off, the surface reverts back to its original state. However, the smoothing operation remains in the surface operation list, and it can be turned on again.

NNI is a method used to estimate the elevation (Z) of an arbitrary point (P) from a set of points with known elevations.

This method uses information in the triangulation of the known points to compute a weighted average of the elevations of the natural neighbors of a point.

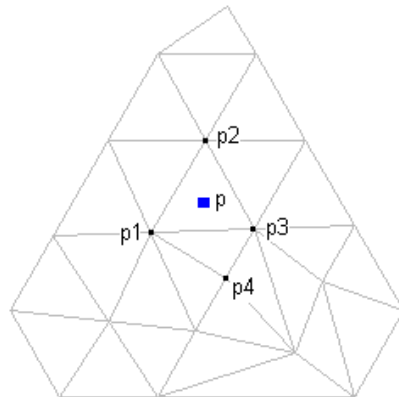

To use NNI, specify only the output locations of the interpolated points. The elevations of the interpolated points are always based on the weighted average of the elevations of the existing neighboring points. NNI interpolates only within the surface.

Exercise 1: Swapping TIN Edges

In this exercise, you will swap several TIN edges in a surface.

For more information, see the AutoCAD Civil 3D Help topic *Swapping Edges*.



Swap TIN edges

- 1 Open *Surface-4A.dwg*, which is located in the [tutorial drawings folder](#) (page 819).

In this drawing, the surface is displayed as TIN lines overlaid on an externally referenced landbase image.

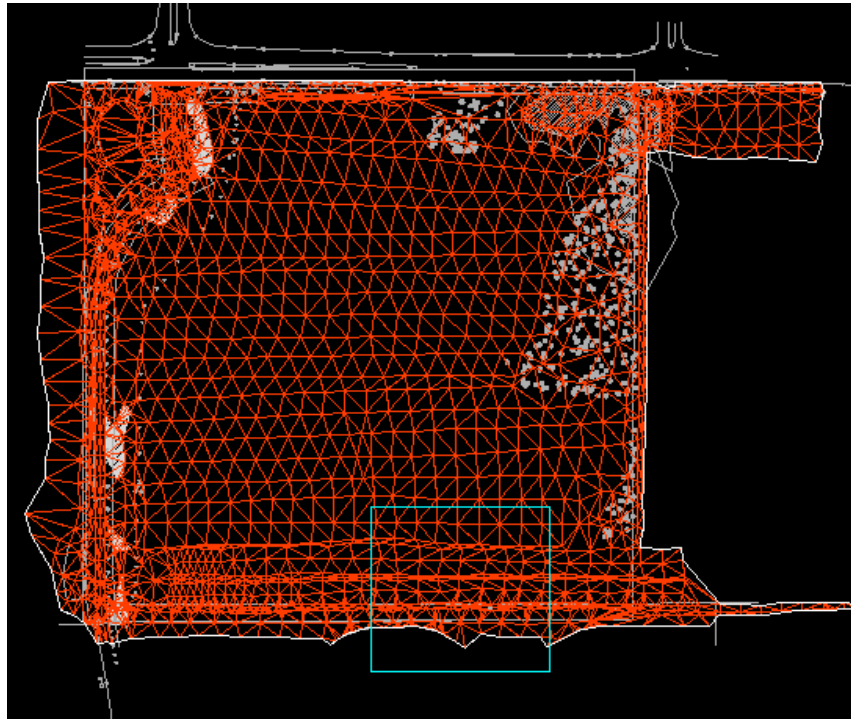
- 2 Zoom in to the lower edge of the surface.



- 3 In Toolspace, on the Prospector tab, expand the surface  Definition collection. Right-click  Edits.
- 4 Click Swap Edge.
On the command line, you are prompted to select an edge (line) to swap.
- 5 Click a TIN edge to swap it.

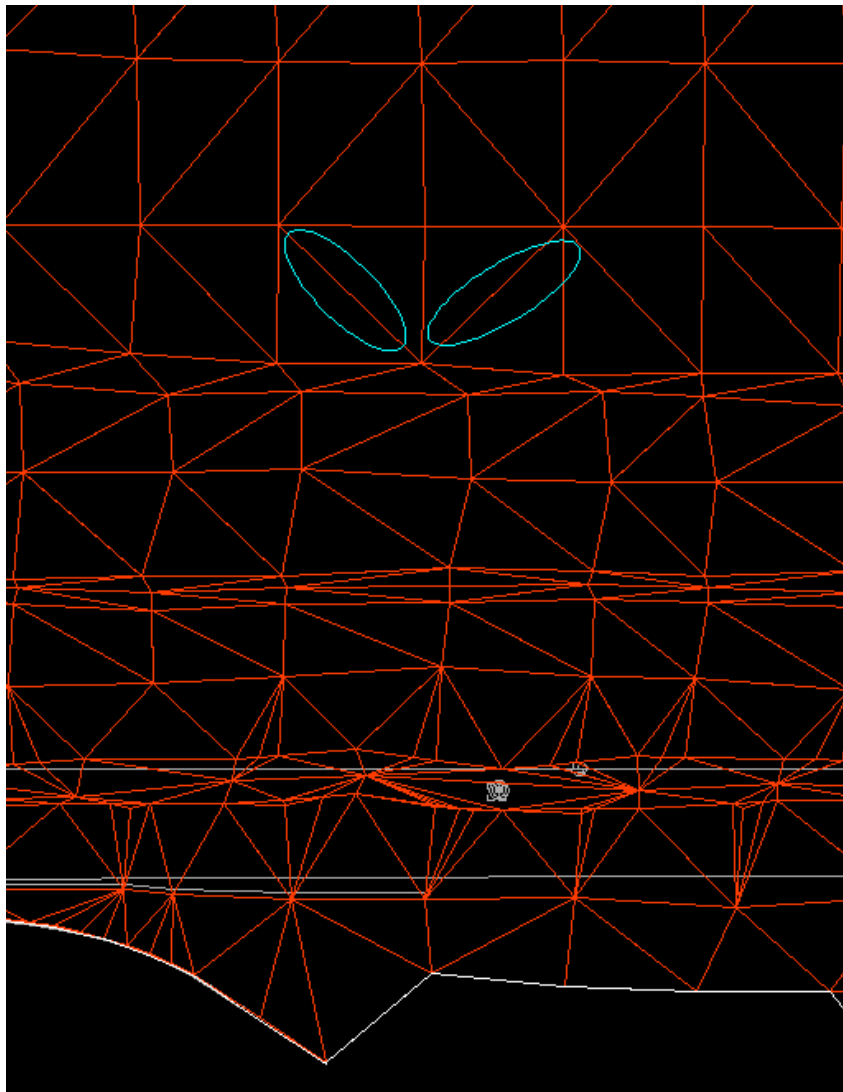

The edge is swapped if the following criteria are met:

- Two visible triangles are separated by the edge.
 - The quadrilateral formed by the two triangles (which are separated by the edge) is convex.
- 6 Optionally, continue to click other TIN edges to swap them.

- 7 Press Enter to end the command.

The edits are added as Swap Edge operations to the Edits list view on the Prospector tab.

NOTE The Description column in the list view provides the coordinates of the pick point along the edge that was swapped.

To continue this tutorial, go to [Exercise 2: Deleting TIN Lines](#) (page 91).

Exercise 2: Deleting TIN Lines

In this exercise, you will delete TIN lines from a surface.

The TIN lines fall within a pond. By removing these lines, you can prevent contours from being drawn through the pond area.



For more information, see the AutoCAD Civil 3D Help topic *Deleting TIN or Grid Lines*.

This exercise continues from [Exercise 1: Swapping TIN Edges](#) (page 88).

Delete TIN lines

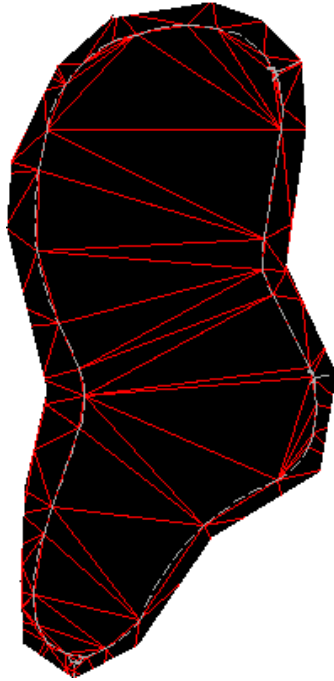
- 1 Open *Surface-4B.dwg*, which is located in the [tutorial drawings folder](#) (page 819).
In this drawing, the surface is displayed as TIN lines overlaid on an externally referenced landbase image.
- 2 Zoom in to the rounded pond area in the upper left of the surface.



- 3 In Toolspace, on the Prospector tab, expand the surface  Definition collection, and right-click the  Edits item.
- 4 Click Delete Line.
On the command line, you are prompted to select an edge (line) to remove.
- 5 Click an edge that crosses the surface of the pond. Press Enter.
The edge is removed and an interior border is created, following the adjacent TIN lines.
- 6 Repeat the Delete Line command and remove all TIN lines that cross the pond surface.

TIP Enter C on the command line to use crossing selection during the delete line command.

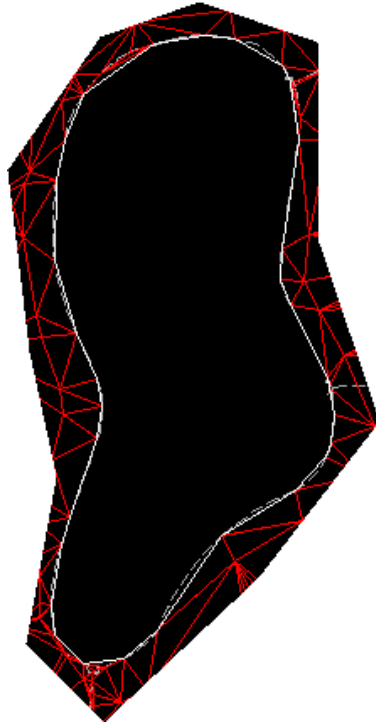

The edits are added as Delete Line operations to the Edits list view in Prospector.

NOTE The Description column in the list view provides the coordinates of the vertices for the edge that was deleted.

To continue this tutorial, go to [Exercise 3: Adding a Hide Boundary](#) (page 93).

Exercise 3: Adding a Hide Boundary

In this exercise, you will create a hide boundary on the surface, which will mask unwanted triangulation.

A boundary can be created from any polygon or polyline, but in this exercise you will use an existing breakline.

For more information, see the AutoCAD Civil 3D Help topic *Boundaries*.

This exercise continues from [Exercise 2: Deleting TIN Lines](#) (page 91).

Add a hide boundary

- 1 Open *Surface-4C.dwg*, which is located in the [tutorial drawings folder](#) (page 819).

NOTE This drawing is similar to *Surface-3A.dwg* with the addition of the C-TOPO-BRKL layer, which displays breaklines.

- 2 In Toolspace, on the Prospector tab, under the Surfaces collection, expand the **XGND** surface.
- 3 Under the **XGND** surface, expand the Definition collection. Right-click  Boundaries. Click Add.
- 4 In the Add Boundaries dialog box, specify the following parameters:
 - Name: XGND-Pond Hide
 - Type: Hide
 - Non-Destructive Breakline: Selected
 - Mid-Ordinate Distance: 1.0000
- 5 Click OK.
- 6 In the drawing, select the polyline object that matches the perimeter of the pond.

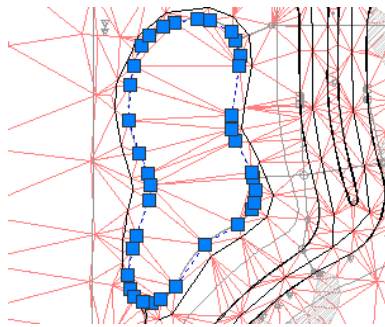

- 7 Press Enter.
The hide boundary is added to the surface definition. The surface displayed in the drawing is modified to display the pond as a 'hole' in the surface.

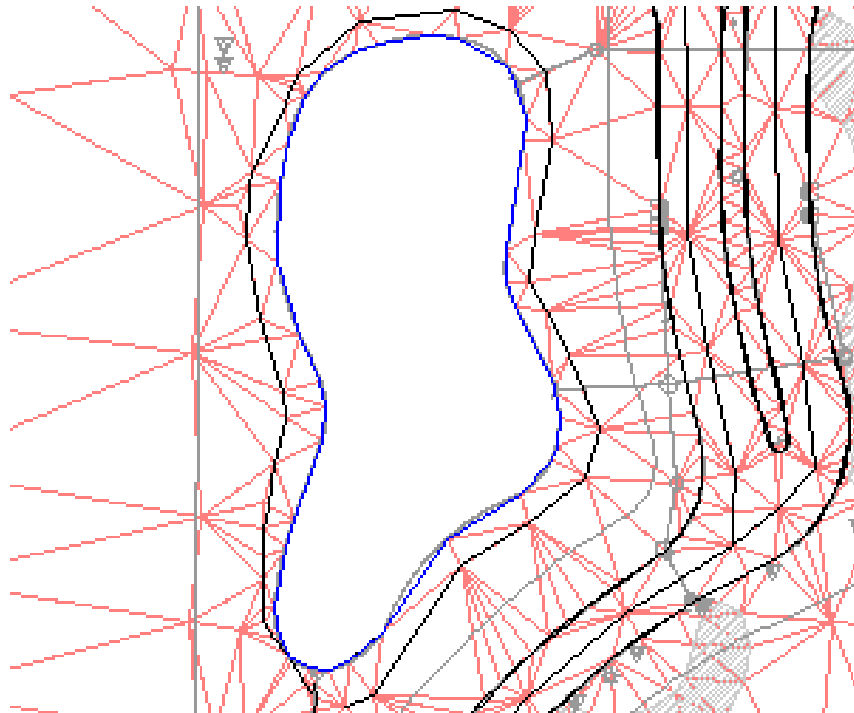

To continue this tutorial, go to [Exercise 4: Smoothing a Surface](#) (page 95).



Exercise 4: Smoothing a Surface

In this exercise, you will smooth a surface using the Natural Neighbor Interpolation (NNI) method.

For more information, see the AutoCAD Civil 3D Help topic *Smoothing Surfaces*.

This exercise continues from [Exercise 3: Adding a Hide Boundary](#) (page 93).

Smooth a surface using NNI

- 1 Open *Surface-4D.dwg*, which is located in the [tutorial drawings folder](#) (page 819).
- 2 In Toolspace, on the Prospector tab, expand the XGND surface  Definition collection and right-click  Edits.

- 3 Click Smooth Surface.
- 4 In the Smooth Surface dialog box, specify the following parameters:
 - Select Method: Natural Neighbor Interpolation
 - Output Locations: Grid Based
The Grid Based output location interpolates surface points on a grid defined within specified polygon areas selected in the drawing. After the areas are defined, you can specify the grid X and Y spacing and orientation properties.
- 5 For the Select Output Region parameter, click the Value column. Click .
- 6 On the command line, enter **Surface** for the output region. This option will smooth the whole surface, rather than just the area within a specified rectangle or polygon.
- 7 In the Smooth Surface dialog box, specify the following parameters:
 - Grid X-Spacing: 10
 - Grid Y-Spacing: 10
- 8 In the drawing window, notice where some of the contour lines are especially angular. Click OK to smooth the surface.
The display of the surface is smoothed; contours are less angular. A Smooth Surface item is added to the Edits list view on the Prospector tab.

NOTE The Description column in the list view displays the type of surface smoothing that was used (Natural Neighbor Smoothing). You can delete the Smooth Surface edit from the list, but this does not reverse the smoothing operation until you rebuild the surface. You can also reverse the smoothing operation by using the U (undo) command.

To continue to the next tutorial, go to [Creating a Watershed and Water Drop Analysis](#) (page 96).

Tutorial: Creating a Watershed and Water Drop Analysis

This tutorial demonstrates how to create two kinds of surface analysis: watershed and water drop.

You use watershed analysis, which is one of several types of analysis that you can perform on a surface, to visualize and analyze the surface watersheds. You use water drop analysis, which is a separate utility, to trace the path that water would take across a surface. This tutorial includes the following general steps:

- Configuring the watershed display and legend settings.
- Configuring and creating a watershed analysis.
- Inserting the watershed legend table.
- Extracting objects from a surface.
- Configuring and creating a water drop analysis.
- Creating a catchment area.

AutoCAD Civil 3D uses the surface TIN lines to calculate the areas that water would flow along the surface. From these areas, the drain targets and watersheds are determined.

Other types of surface analysis include slope, aspect, elevations, and contours.

For more information, see the AutoCAD Civil 3D Help topics *Watersheds* and *Analyzing Surfaces*.



Exercise 1: Configuring a Style for Watershed Display

In this exercise, you will configure a style for watershed display.

For more information, see the AutoCAD Civil 3D Help topic *Surface Styles and Visualization*.

Configure a style for watershed display

- 1 Open *Surface-5A.dwg*, which is located in the [tutorial drawings folder](#) (page 819).
- 2 In Toolspace, on the Settings tab, expand the Surface ► Surface Styles. Right-click the Standard surface style. Click Copy.
- 3 In the Surface Style dialog box, on the Information tab, for Name, enter Watersheds.
- 4 On the Watersheds tab, in the Watershed Properties table, expand the Depression Watershed property group. Change Use Hatching to True.

- 5 Click Hatch Pattern and click .
- 6 In the Hatch Properties dialog box, specify the following parameters:
 - Pattern: AR-SAND
 - Scale: 15
- 7 Click OK.
- 8 On the Display tab, in the Component Display table, click  next to Watersheds to turn on display of the watershed components.
- 9 Click OK.

To continue this tutorial, go to [Exercise 2: Generating a Watershed Analysis](#) (page 98).

Exercise 2: Generating a Watershed Analysis

In this exercise, you will generate and display the watershed analysis.



For more information, see the AutoCAD Civil 3D Help topic *Analyzing Surfaces*.

This exercise continues from [Exercise 1: Configuring a Style for Watershed Display](#) (page 97).

Generate a watershed analysis

NOTE This exercise uses *Surface-5A.dwg* with the modifications you made in the previous exercise.

- 1 In Toolspace, on the Prospector tab, expand the Surfaces collection. Right-click the XGND surface. Click Surface Properties.
- 2 In the Surface Properties dialog box, on the Information tab, for Surface Style, select Watersheds.
- 3 On the Analysis tab, for Analysis Type, select Watersheds.
- 4 Ensure that Standard is selected in the Legend list.
- 5 Click  to generate the watershed analysis.
The details of the surface watersheds are displayed in the Details table.

- 6 Click  .
- 7 On the Watershed Display dialog box, click  next to Boundary Point and Boundary Segment to turn off the display of these watershed types.
- 8 Click OK twice.
The watersheds are displayed on the surface in the drawing.
- 9 In Toolspace, on the Prospector tab, expand the Surfaces ► XGND collection. Click the Watersheds collection.
The Prospector list view displays a tabular list of the surface watersheds with their IDs, description, type, and the ID of the watershed that they drain into.
- 10 Optionally, pan or zoom to an individual watershed. Right-click the watershed item in the list view and click Pan To or Zoom To.

To continue this tutorial, go to [Exercise 3: Creating a Watershed Legend](#) (page 99).

Exercise 3: Creating a Watershed Legend

In this exercise, you will add a watershed legend table to the drawing.

For more information, see the AutoCAD Civil 3D Help topic *Adding Surface Legend Tables*.

This exercise continues from [Exercise 2: Generating a Watershed Analysis](#) (page 98).

Create a watershed legend table

NOTE This exercise uses *Surface-5A.dwg* with the modifications you made in the previous exercise, or you can open *Surface-5B.dwg* from the [tutorial drawings folder](#) (page 819).

- 1 In Toolspace, on the Settings tab, expand the Surface ► Table Styles ► Watershed collection.
- 2 Right-click the Standard style. Click Edit.
- 3 In the Table Style dialog box, on the Data Properties tab, clear the Sort Data check box.

- 4 Click OK.
- 5 Click Annotate tab ► Labels & Tables panel ► Add Tables menu ► Add Surface Legend Table.
- 6 At the prompt to specify the table type, enter Watersheds.
- 7 You are prompted to specify whether you want the table to automatically update if the analysis information changes. Enter Dynamic to enable automatic updating.
If a change is made to the surface and the watershed analysis is regenerated, the legend is automatically updated.
- 8 Click a location in the drawing where you want to place the upper-left corner of the table.
The legend table is displayed in the drawing at the selected location.

To continue this tutorial, go to [Exercise 4: Extracting Objects from a Surface](#) (page 100).

Exercise 4: Extracting Objects from a Surface

In this exercise, you will use the watershed data to create non-destructive AutoCAD objects from the surface.

For more information, see the AutoCAD Civil 3D Help topic *Extracting Surface Data*.

This exercise continues from [Exercise 3: Creating a Watershed Legend](#) (page 99).

Extract objects from a surface

NOTE This exercise uses *Surface-5B.dwg* with the modifications you made in the previous exercise.

- 1 In the drawing, select the surface.
- 2 Click TIN Surface tab ► Surface Tools panel ► Extract Objects .
- 3 The Extract Objects From Surface dialog box lists all of the surface properties that are visible in the currently selected surface style. Clear all boxes in the Properties column except for Watersheds.
- 4 Click OK.

AutoCAD objects are created from each of the watersheds in the drawing.

- 5 In the drawing, click inside a watershed area.
A blue grip appears inside the area, indicating that you have selected an AutoCAD object.
- 6 On the command line, enter List.
The AutoCAD text window displays parameters for the object you selected.
You can use any of the standard AutoCAD commands to modify or query the new object.

To continue this tutorial, go to [Exercise 5: Analyzing Surface Water Runoff](#) (page 101).

Exercise 5: Analyzing Surface Water Runoff

In this exercise, you will create lines that illustrate the path that flowing water would take across a surface. Then, you will create a polygon that defines the catchment region and its area on the surface.

The water drop utility creates either a 2D or 3D polyline object that runs downhill on a surface from any point you select. You can specify whether the point you select is indicated with a marker. After the lines are created, you can edit or modify them as needed.

You can use the information you get from the water drop analysis to calculate catchment areas, based on specified low points of the surface. The catchment regions can be created on the surface as either 2D or 3D polygons, which can be exported to a hydrology application for detailed analysis.

For more information, see the AutoCAD Civil 3D Help topics *Drawing Water Drop Paths* and *Displaying and Calculating Catchment Areas*.

This exercise uses a drawing file similar to the one used in [Exercise 3: Creating a Watershed Legend](#) (page 99). The surface style is changed to make it easier to see the basic surface features, and it contains a simple point style for you to use as a start point marker.

This exercise continues from [Exercise 4: Extracting Objects from a Surface](#) (page 100).

Perform a water drop analysis

- 1 Open *Surface-5C.dwg*, which is located in the [tutorial drawings folder](#) (page 819).

- 2 Click Analyze tab ► Ground Data panel ► Water Drop .
- 3 In the Water Drop dialog box, specify the following parameters.
 - Path Layer: C-TOPO-WDRP
 - Path Object Type: 2D Polyline
 - Place Marker At Start Point: Yes
 - Start Point Marker Style: WD Start
- 4 Click OK.

- 5 In the drawing, click several locations near those displayed in the following illustration.

A 2D polyline is drawn, representing the flow of water from the spot you

selected. The start point of the path is indicated by a  marker.

If a water path splits, additional lines are drawn to follow each path.

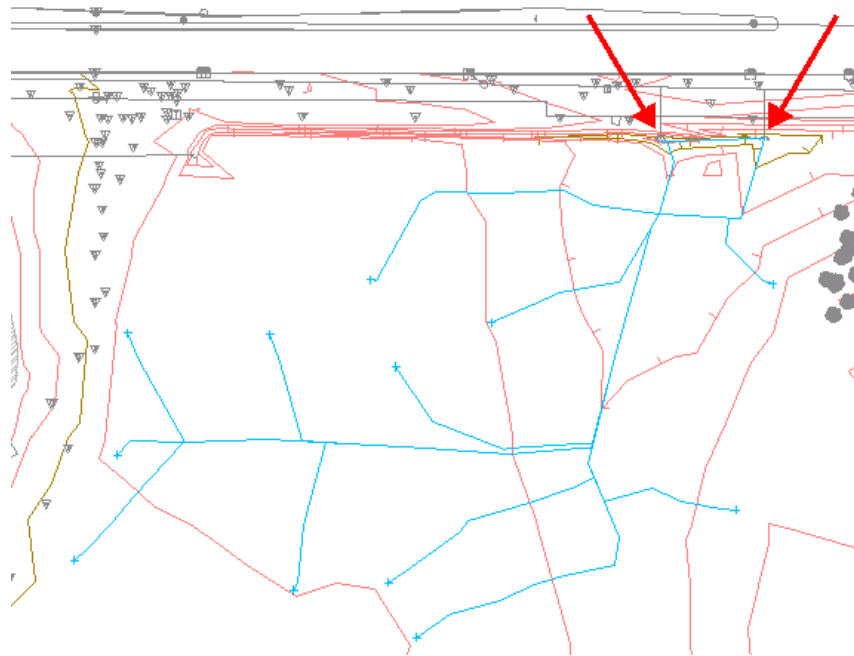



Waterdrop paths (arrows indicate culvert inlet locations)

- 6 Press Enter to end the waterdrop command.

Notice that most waterdrop paths in this area drain to the culverts that are indicated by the red arrows. Next, you will use the water drop paths you just created to define a catchment area that influences the culverts.

Create catchment areas

- 1 Click Analyze tab ► Ground Data panel ► Catchment Area .
- 2 In the Water Drop dialog box, specify the following parameters:
 - Catchment Layer: C-TOPO-CATCH
 - Catchment Object Type: 2D Polyline
 - Catchment Marker: Yes
 - Catchment Marker Style: Catchment Area
- 3 Click OK.

- 4 In the drawing, click the  marker for each waterdrop path. Blue polygons that define each catchment region are created. The area value of each catchment region is displayed on the command line. In the drawing, each catchment point is indicated by a  marker.

NOTE If you receive a message indicating that the specified location results in a catchment area with no area, it means that there is no flat area or high spot on the specified point.

- 5 Press Enter to end the catchment area command.

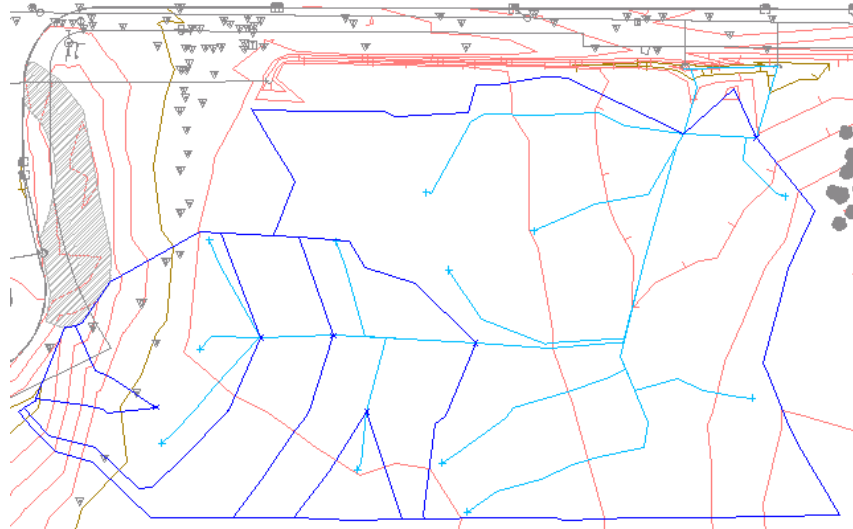

Catchment areas defined

Combine multiple catchment areas

- 1 In the drawing, select the polygons that define catchment areas.
Right-click. Select Isolate Objects ► Isolate Selected Objects.
The polygons are displayed in the drawing window, but all other objects are hidden.
- 2 Select the polygons again.
- 3 On the command line, enter `LineWorkShrinkWrap`.
A black polygon that contains the combined area of the catchment areas is displayed. The `LineWorkShrinkWrap` command creates a single outside boundary of a selection of touching polygons. The original polygons are not deleted.

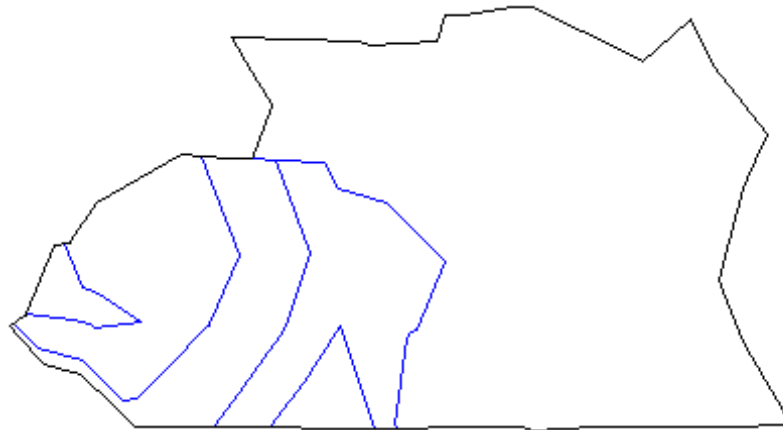

Combined catchment areas

- 4 In the drawing, right-click. Click Isolate Objects ► End Object Isolation. The remaining drawing objects are displayed in the drawing window.

TIP You can transfer individual or shrinkwrapped catchment area polygons to a hydrology application for further analysis.

To continue to the next tutorial, go to [Generating Surface Volume Information](#) (page 105).

Tutorial: Generating Surface Volume Information

This tutorial demonstrates how to create base and comparison surfaces, create a composite volume surface from those surfaces, and then perform composite volume calculations.

A *volume surface* is similar to other surface objects, in that you can display cut and fill contours, cut and fill points, add labels to it, and add it to a project. The cut, fill, and net volumes are properties that can be viewed by selecting Surface Properties.

The *composite volume* method uses the points from two surfaces, as well as any location where the triangle edges between the two surfaces cross. The cut, fill, and net volumes are calculated based on the elevation differences between the two surfaces.

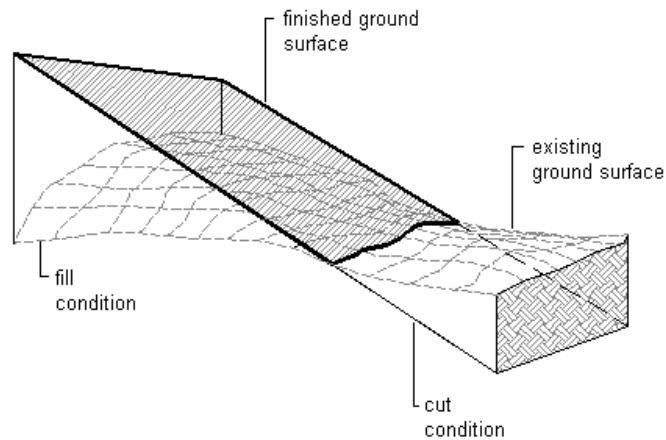

For more information, see the AutoCAD Civil 3D Help topic *Calculating Surface Volumes*.

Exercise 1: Creating the Base and Comparison Surfaces

In this exercise, you will create base and comparison surfaces, from which to derive volume calculations.

For more information, see the AutoCAD Civil 3D Help topic *Creating Surfaces*.

To create a base surface

- 1 Open *Surface-6.dwg*, which is located in the [tutorial drawings folder](#) (page 819).

The surface (Existing Ground without Berm) in this file is similar to the one in *Surface-5A.dwg* except that there is no berm at the south end of the surface. This surface will be the base surface for the volume calculations.

- 2 Click Home tab ► Create Ground Data panel ► Surfaces drop-down ► Create Surface .
- 3 In the Create Surface dialog box, specify the following parameters:
 - Type: TIN Surface
 - Name: Berm
 - Description: Berm surface

- Style: Standard
 - Render Material Style: ByLayer
- 4 Click OK.
 - 5 In Toolspace, on the Prospector tab, expand the drawing Surface-6 and the Surfaces collection.
The Berm surface is listed in the Surfaces collection, but it does not contain any data. This will be the comparison surface for the volume calculations.

Insert 3D polylines into the drawing

- 1 Click Insert tab ► Block panel ► Insert.
- 2 In the Insert dialog box, click Browse. Navigate to the [tutorial drawings folder](#) (page 819). Select *Berm Breaklines.dwg*. Click Open.
- 3 In the Insert dialog box, specify the following parameters:

Insertion Point

- Specify On Screen: Cleared
- X: 0.0000
- Y: 0.0000
- Z: 0.0000

Scale

- Specify On Screen: Cleared
- X: 1.0000;
- Uniform Scale: Selected

Rotation

- Specify On Screen: Cleared
- Angle: 0

Explode

- Explode: Selected
- 4 Click OK.
The polylines are inserted into the drawing.

Add 3D polylines to the surface as breaklines

- 1 On the command line, enter QSelect.
- 2 In the Quick Select dialog box, specify the following parameters:
 - Apply To: Entire Drawing
 - Object Type: 3D Polyline
 - Properties: Layer
 - Operator: = Equals
 - Value: C-TOPO-BRKL
 - Include In New Selection Set: Selected
- 3 Click OK.
The 3D polylines are selected in the drawing.
- 4 In Toolspace, on the Prospector tab, expand the Surfaces ► Berm surface collection.
- 5 Under the Berm surface, expand the Definition collection. Right-click Breaklines. Click Add.
- 6 In the Add Breaklines dialog box, specify the following parameters:
 - Description: Berm-Breaklines
 - Type: Standard
 - Mid-Ordinate Distance: 1.0000
- 7 Click OK.
The previously selected 3D polylines are added to the surface definition as breaklines. The surface displayed in the drawing updates.

To continue this tutorial, go to [Exercise 2: Creating a TIN Volume Surface](#) (page 109).

Exercise 2: Creating a TIN Volume Surface



In this exercise, you will create a TIN volume surface. A TIN volume surface is a persistent, differential surface object created from a composite of points based on base and comparison surfaces.

For more information, see the AutoCAD Civil 3D Help topic *Creating a TIN Volume Surface*.

This exercise continues from [Exercise 1: Creating the Base and Comparison Surfaces](#) (page 106).

Create a TIN volume surface

NOTE This exercise uses *Surface-6.dwg* with the modifications you made in the previous exercise.

- 1 Click Home tab ► Create Ground Data panel ► Surfaces drop-down ► Create Surface .
- 2 In the Create Surface dialog box, specify the following parameters:
 - Type: TIN Volume Surface
 - Name: Berm Volume
 - Description: Berm volume difference surface
 - Style: Standard
 - Render Material: ByLayer
- 3 Under the Volume Surfaces property group, click <Base surface>. Click .
- 4 In the Select Base Surface dialog box, select Existing Ground Without Berm.
- 5 Click OK.
- 6 Under the Volume Surface property group, click <Comparison surface>. Click .
- 7 In the Select Comparison Surface dialog box, select Berm.
- 8 Click OK twice.
- 9 In Toolspace, on the Prospector tab, expand the Surfaces collection.

The Berm Volume surface is listed in the collection, with an icon  to indicate that it is a TIN volume surface.

View the volume surface statistics

- 1 On the Prospector tab, right-click the Berm Volume surface. Click Surface Properties.
- 2 In the Surface Properties dialog box, click the Statistics tab. Expand the Volume statistics to see the cut, fill, and net volumes.

Further exploration: If you want to add the data from the Statistics tab to the drawing, right-click the statistics table and click Copy To Clipboard. Then close the Surface Properties dialog box, zoom in to a clear space in the drawing, right-click, and click Clipboard ► Paste. The entire contents of the Statistics tab (General, TIN, and Volume) are pasted in. To edit the text content and format, right-click and click MText Edit. Another useful option is to paste the statistical data from the clipboard into a separate spreadsheet.

- 3 If necessary, click OK to close the Surface Properties dialog box.

To continue this tutorial, go to [Exercise 3: Creating a Composite Volume Calculation](#) (page 110).

Exercise 3: Creating a Composite Volume Calculation

In this exercise, you will use the Composite Volume utility to calculate volume information between two surfaces.

For more information, see the AutoCAD Civil 3D Help topic *Calculating Composite Volumes*.

This exercise continues from [Exercise 2: Creating a TIN Volume Surface](#) (page 109) and presents an alternative method for generating the surface volume statistics.

Create composite volume information

NOTE This exercise uses *Surface-6.dwg* with the modifications you made in the previous exercise.

- 1 Click Analyze tab ► Volumes And Materials panel ► Volumes drop-down ► Volumes  .

- 2 In the Composite Volumes vista, click  Create New Volume Entry.
- 3 In the Base Surface column, click <select surface>. Select the Existing Ground Without Berm surface from the list.
- 4 In the Comparison Surface column, click the <select surface>. Select the Berm surface from the list.

After the surfaces are selected, the volumes are calculated and displayed in the table. The Net Graph entry shows a graphical percentage representation of the whole volume. A net fill condition is represented by a green bar; a net cut condition by a red bar.

To continue to the next tutorial, go to [Visualizing Surface Data](#) (page 111).

Tutorial: Visualizing Surface Data

This tutorial demonstrates how to add multi-view blocks to a surface and render it using a sample of the visualization techniques included with AutoCAD Civil 3D.

AutoCAD Civil 3D uses the same rendering functionality as standard AutoCAD. At a basic level, you can use the Render command to render your model without applying any materials, adding any lights, or setting up a scene. In this tutorial, you will create a basic rendering by applying a render material to a surface. You will explore some of the basic render settings that are available.

For more information, see the AutoCAD help topic *Create Realistic Images and Graphics*.

Exercise 1: Moving Multi-View Blocks to a Surface

In this exercise, you will insert multi-view blocks into a drawing, and then place them at the appropriate elevation on a surface.

A multi-view block is an AutoCAD Civil 3D object that can have different representations in different view directions.

Predefined multi-view blocks supplied with AutoCAD Civil 3D are available in DesignCenter. These blocks represent various items, such as signs, building footprints, trees, and shrubs. In DesignCenter, predefined multi-view blocks are located in the [Data folder](#) (page 819) \Symbols\Mvblocks.

For more information, see the AutoCAD Civil 3D Help topic *Multi-View Blocks*.

Insert multi-view blocks into the drawing

- 1 Open *Surface-7.dwg*, which is located in the [tutorial drawings folder](#) (page 819).
- 2 Click View tab ► Views panel ► views list ► Plan Detail.
The drawing view shows a two-way road with a median separating the lanes.
- 3 Click View tab ► Palettes panel ► Design Center.
- 4 In DesignCenter, navigate to the [Data folder](#) (page 819) \Symbols\Mvblocks. Select the Mvblocks folder in the left pane. In the right pane, examine the blocks that are available.

NOTE Before continuing with this exercise, either dock the DesignCenter palette or click  to autohide it.

- 5 In the right pane, select *R4-7a Keep Right.dwg*. Right-click. Click Insert As Block.
- 6 In the Insert dialog box, specify the following parameters:
 - Insertion Point - Specify On Screen: Selected
 - Scale - Specify On Screen: Selected
 - Scale - Uniform Scale: Selected
 - Rotation - Specify On Screen: Selected
 - Explode: Cleared
- 7 Click OK.
- 8 When prompted to specify an insertion point in the drawing window, click the  symbol at the bottom of the median.
- 9 Press Enter to accept the default scale factor of 1.
- 10 When prompted to specify the rotation angle, zoom in to the insertion point and rotate the block until the sign is parallel with the symbol. Click to set the angle of rotation.

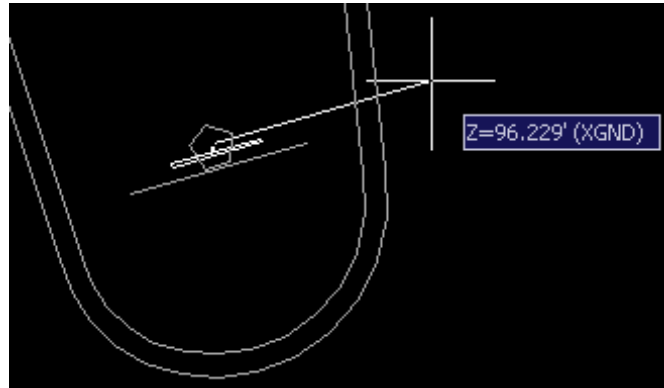



- 11 Repeat steps 6 and 7 to insert the *Light Pole 01.dwg* block.
When prompted to specify an insertion point in the drawing window,



click the  symbol near the middle of the median. Press Enter to accept the default scale factor and rotation angle.

Move multi-view blocks to the surface

- 1 Click View tab ► Views panel ► views list ► 3D Detail.
In the 3D view, notice that the street light block appears at the lower portion of the drawing and is not at the appropriate surface elevation. In the following steps, you will move both blocks onto the surface.
- 2 Click Modify tab ► Ground Data panel ► Surface.
- 3 Click Surface tab ► Surface Tools panel  Move Blocks To Surface .
- 4 In the Move Blocks To Surface dialog box, in the Select Block Reference Names field, select Light Pole 01 and R4-7a Keep Right.
- 5 Click OK. Each selected block moves from its current elevation to the surface elevation at the block's insertion point.

To continue this tutorial, go to [Exercise 2: Rendering a Surface](#) (page 114).

Exercise 2: Rendering a Surface

In this exercise, you will use some of the visualization features in AutoCAD Civil 3D to render a surface.

Like other AutoCAD Civil 3D objects, you must apply a render material to the surface using the Surface Properties dialog box.

For more information, see the AutoCAD Civil 3D Help topic *Object Rendering*.

This exercise continues from [Exercise 1: Moving Multi-View Blocks to a Surface](#) (page 111).



Apply a render material to the surface

NOTE This exercise uses *Surface-7.dwg* with the modifications you made in the previous exercise.

- 1 In Toolspace, on the Prospector tab, expand the Surfaces collection.
- 2 Right-click the XGND surface. Click Surface Properties.
- 3 In the Surface Properties dialog box, on the Information tab, specify the following parameters:
 - Render Material: Sitework.Planting.Sand
This render material displays contrast in the surface elevations.
 - Surface Style: Standard
- 4 Click OK.

Apply a visual style to the surface

Visual Styles give a fast, basic visualization of the surface that is useful for on-screen presentation in AutoCAD Civil 3D.

- 1 Click View tab ► Views panel  Visual Styles drop-down ► Realistic.
This visual style shades the surface and smooths the edges between polygon faces. The render material that you applied to the surface is displayed.
- 2 Click View tab ► Views panel  Visual Styles drop-down ► Conceptual.
This visual style shades the surface and smooths the edges between polygon faces. The shading in this style uses the Gooch face style, a transition between cool and warm colors rather than dark to light. The

effect is less realistic, but it can make the details of the model easier to see.

Render the surface

- 1 On the command line, enter RPREF.

Examine the many render settings that are available, including variations in image quality and output size. If you wanted to save the rendered image to a file, you would click  and use the Output File Name control to specify a file name and destination.



- 2 Click  .

The surface and blocks are rendered in the Render window. The effects of rendering are more apparent in a drawing that has different render materials applied to several surfaces and objects.



To continue to the next tutorial, go to [Obtaining an Aerial Image and Draping It on a Surface](#) (page 116).

Tutorial: Obtaining an Aerial Image and Draping It on a Surface

This tutorial demonstrates how to drape an image on an AutoCAD Civil 3D surface object.

You can drape an existing image on a surface. However, this tutorial demonstrates how to obtain a useful image by using the Google Earth™ mapping service import/export features in AutoCAD Civil 3D.

The Drape Image command combines the following operations into a few simple steps:

- A new render material is created from the source image, with mapping based on the scale, position, and rotation of the source image.
- The new render material is applied to the selected surface object. Like other render materials, the effect of the draped image is visible only when viewing the image in 3D.

NOTE AutoCAD Civil 3D makes it easy to retrieve low-resolution, public image and terrain data from Google Earth. While the data you can retrieve from Google Earth may not be suitable for detailed design, it can be useful for project planning and presentation.

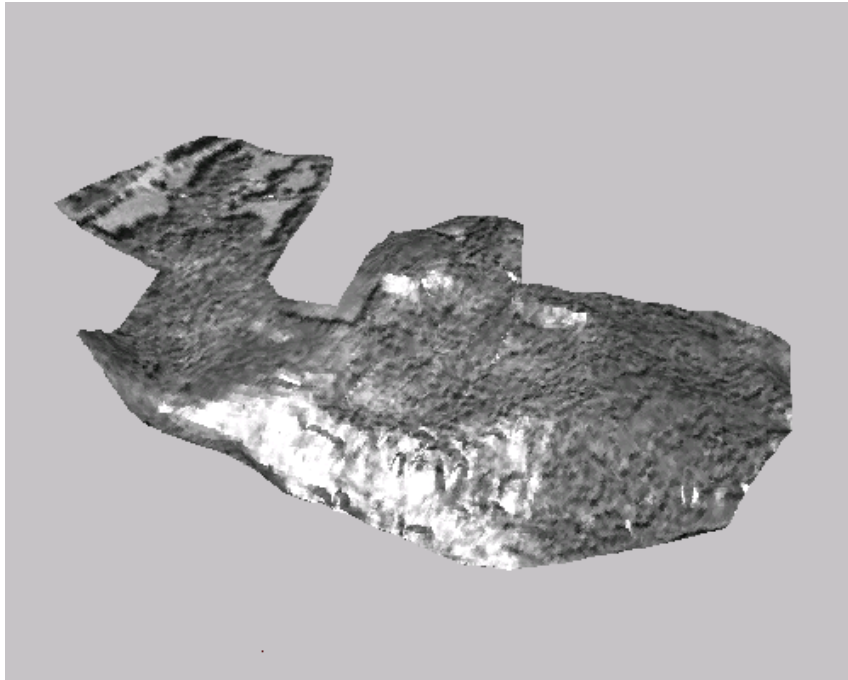

For more information, see the AutoCAD Civil 3D Help topics *Draping Images on Surfaces* and *Google Earth Import and Export*.

Exercise 1: Publishing Surface Data to Google Earth

In this exercise, you will publish the surface data of a drawing to Google Earth. Then, Google Earth will use the coordinate system specified in the drawing settings to retrieve an image of the area around the surface.



The coordinate system specified in the drawing settings will be used to transform data as it is imported to or exported from Google Earth.

NOTE For best results, make sure that you have Google Earth version 4.0 or later.

For more information, see the AutoCAD Civil 3D Help topic *Publishing Civil Data to Google Earth*.

Publish surface data to Google Earth

- 1 Open *Surface-8.dwg*, which is located in the [tutorial drawings folder](#) (page 819).

- 2 Start Google Earth.
- 3 Click Output tab ► Publish panel ► Publish To Google Earth .
- 4 In the Publish AutoCAD DWG To Google Earth wizard, on the Describe page, you can enter information that will be used to create a new, temporary entry in the Temporary Places folder, in the Places pane in Google Earth.
Specify the following parameters:
 - Name: Aerial Mapping_NH83F
This field is automatically populated by the drawing name.
 - Description: Aerial mapping of a project in New Boston, NH
 - Hyperlink: blank
- 5 Click Next.
- 6 On the Items page, select the Selected Model Space Entities option.
This makes the  button available, which you use to pick the specific objects in the drawing that you want to publish to Google Earth.
- 7 Click .
- 8 When you are prompted to select an object, pan and zoom to the upper left corner of the surface. Click the red line that defines the extents of the surface. If you pan or zoom to click the border, reset the zoom by entering 'Z', and then P on the command line. Press Enter to accept the selection.

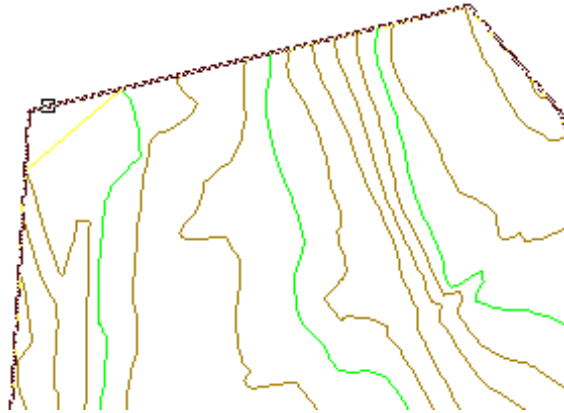

- 9 In the Publish AutoCAD DWG To Google Earth wizard, on the Items page, notice that one entity (the surface extents boundary) has been selected. Ensure that Publish Entity Information is selected.
- 10 Click Next.
- 11 On the Geo-Reference page, notice that the Drawing Coordinate System Transform option is selected. NAD83 New Hampshire State Planes, US Foot is listed as the zone. This information is taken directly from the world coordinate system setting specified in the drawing settings. Notice that if you select the User-Defined Transform option, you can manually select coordinates. Ensure that the Drawing Coordinate System Transform option is selected.
- 12 Click Next.
- 13 On the Nudge page, you can fine-tune the image location, using DWG linear units. Select the Drape Entities On Ground option.
- 14 Click Next.
- 15 On the File page, you can specify a file location for the KMZ data file that Google Earth creates. Click . Navigate to the [My Civil Tutorial Data folder](#) (page 819). Click Save.
- 16 Click Publish. When the Publishing Status indicates that the model has been 100% published, click View.

Google Earth takes focus, panning and zooming to the specified coordinates and displaying the polygon that defines the extents of the surface. Notice that the name and description that you entered in the Publish AutoCAD DWG To Google Earth wizard has been used to create a new entry in the Temporary Places folder in the Google Earth Places pane. When you exit Google Earth, you are prompted to specify whether to save the new location to the My Places folder.

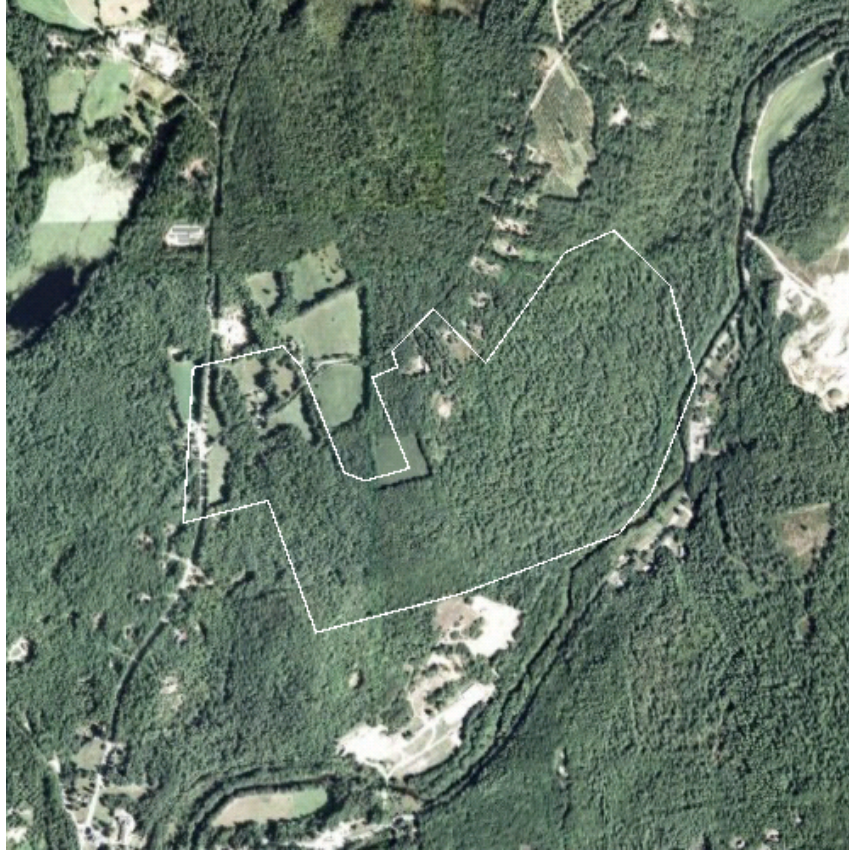

- 17 In the Google Earth window, in the Places pane, under Temporary Places, clear the Aerial Mapping_NH83F check box.

Clearing this check box turns off the polygon that defines the extents of the surface. The polygon was exported from AutoCAD Civil 3D so that you can confirm the image location. Clearing the Aerial Mapping_NH83F

check box turns the polygon off, which prevents it from being imported back into AutoCAD Civil 3D.

NOTE If Google Earth zooms past the polygon, expand the Temporary Places ► Aerial Mapping_NH83F ► Model ► Polyline collection. Double-click Polyline to zoom to the extents of the polyline.

To continue this tutorial, go to [Exercise 2: Importing a Google Earth Image](#) (page 121).

Exercise 2: Importing a Google Earth Image

In this exercise, you will import an aerial image from Google Earth into AutoCAD Civil 3D.

To provide a useful source image, Google Earth must display the image from directly above. If the image is tilted, it will still be captured by AutoCAD Civil 3D. However, it will not be a useful representation of the surface when it is converted to a render material.

When the Google Earth image is imported into AutoCAD Civil 3D, it appears in the drawing as a gray scale image object. The image is scaled by both the linear units in the drawing and the extents of the latitude/longitude of the image. The image aspect ratio matches that of the image displayed in the Google Earth window. AutoCAD Civil 3D automatically generates a name for the image, using the first three letters of the drawing file name and a unique ID number. The image is saved in the same directory as the drawing file.

When the image is draped on the surface, a new render material is created from the image, and the render material is applied to the surface. If the image is larger than the surface, the image is clipped to the extents of the surface object. If multiple, smaller images are needed to cover a surface, you must combine them into a single image.

TIP If you do not want to get your surface image from Google Earth, you can use Autodesk Raster Design to prepare images from other sources. Using Raster Design, you can

- combine multiple images into a single image.
 - convert images to a format (such as BMP, DIB, GIF, JPG, PCX, PNG, RLE, TGA, or TIF) that is suitable for use as a render material.
 - orient and scale an image appropriately for a drawing.
-

For more information, see the AutoCAD Civil 3D Help topic *Importing a Google Earth Image to AutoCAD Civil 3D*.

This exercise continues from [Exercise 1: Publishing Surface Data to Google Earth](#) (page 117).

Import a Google Earth image

NOTE This exercise uses *Surface-8.dwg* with the modifications you made in the previous exercise.

- 1 In Google Earth, ensure that the image is viewed from directly above.
If the Google Earth navigation controls are not visible, hover the cursor over the compass at the upper right-hand corner of the screen:



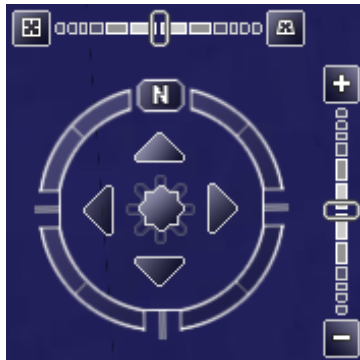

Compass



Navigation Controls

- To reset the tilt so that the image is viewed from directly above, double-click . Alternatively, you can press the R key to reset the tilt.

- To reorient the view so that North is oriented toward the top of the screen, click . Alternatively, you can press the N key to reset the North orientation.
 - To pan back to the view that was originally published, double-click the appropriate link under Temporary Places.
- 2 Click Insert tab ► Import panel ► Google Earth drop-down ► Google Earth Image .
 - 3 When prompted to select a coordinate system for image location, press Enter to accept the default Coordinate System selection.

The gray scale Google Earth image appears in the drawing window in the appropriate location under the surface object. The image was placed on the current layer, which is named Image in the current drawing.

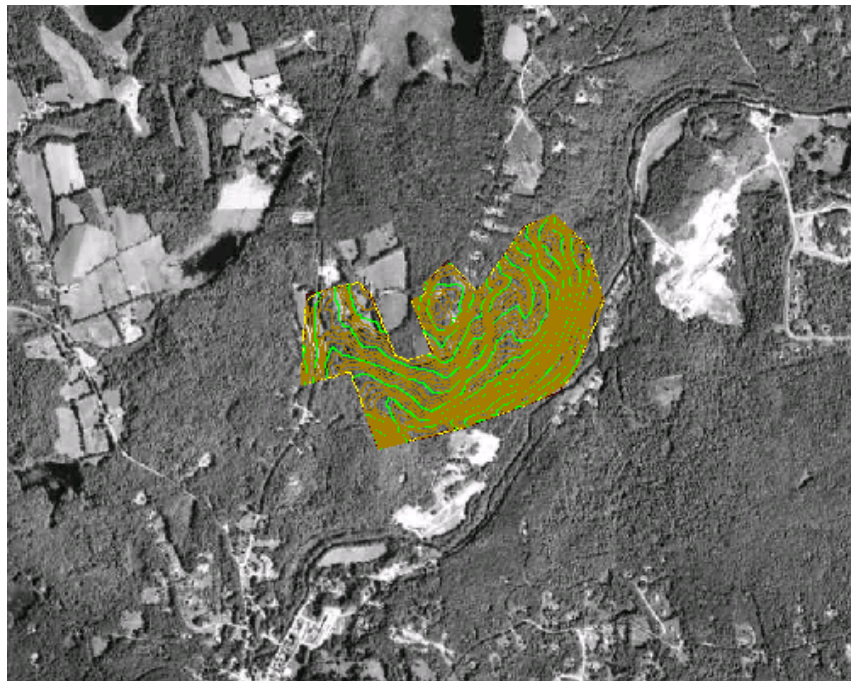

To continue this tutorial, go to [Exercise 3: Draping an Image on a Surface](#) (page 124).

Exercise 3: Draping an Image on a Surface

In this exercise, you will drape an image onto a surface, creating a render material from the image.

First, you will review a surface style to learn about some common settings that provide an acceptable view of the draped image on the surface. When you drape an image on a surface, the image is applied to the surface as a render material. However, it is not evident that you have applied a render material when you view the surface in plan view. The surface style must be set up to view the surface in model.

For more information, see the AutoCAD Civil 3D Help topic *Draping Images On Surfaces*.

This exercise continues from [Exercise 2: Importing a Google Earth Image](#) (page 121).

Examine the surface style

NOTE This exercise uses *Surface-8.dwg* with the modifications you made in the previous exercise.

- 1** In Toolspace, on the Prospector tab, under the drawing name, expand the Surfaces collection. Right-click Aerial Mapping. Click Edit Surface Style.

In the Surface Style dialog box, on the Display tab, examine the current surface style, *5' Contours*. Notice that the style displays the surface border and major and minor contours when the surface is viewed in plan view.
- 2** From the View Direction list, select Model.

Notice that the surface style is set to display only triangles when the surface is viewed in model view.
- 3** Click the Triangles tab.

Notice that the Triangle Display Mode is set to Exaggerate Elevation and the Exaggerate Triangles By Scale Factor is set to 3.000.

These settings specify that when the surface is displayed in model view, the triangle elevations are exaggerated by a factor of three. The exaggeration makes the variations of the surface more obvious than if the surface was not exaggerated.
- 4** Click Cancel.

Drape the image on the surface

- 1 Click Surface tab ► Surface Tools panel ► Drape Image .
- 2 In the Drape Image dialog box, select the following information from the Image and Surface lists. All the images and surfaces available in the current drawing appear in the lists. Alternatively, you can click to pick the image or surface directly in the drawing window.

- Image: SurXXX

- Surface: Aerial Mapping

NOTE The image name is automatically generated when it is imported into AutoCAD Civil 3D. Your image name and render material name may differ from the names that are shown in this tutorial.

The Render Material Name field is populated with an automatically generated name (Aerial Mapping_SurXXX_RenderMaterial). You can change this name as desired, but accept the default for this exercise.

- 3 Click OK.
The image is draped on the surface, but it is not evident in plan view. Next, you will hide the image, and then view the surface in model view.
- 4 In the drawing window, select the image. Right-click. Click Isolate Objects ► Hide Selected Objects.

NOTE To make the image reappear, right-click in the drawing area and click Isolate Objects ► End Object Isolation.

- 5 Click View tab ► Views panel ► views list ► SE Isometric.
This selection specifies an appropriate angle at which to view the surface in 3D.
- 6 On the command line, enter Zoom. When prompted, enter O to select an object.
- 7 When prompted to select an object, in the drawing window, click the surface. Press Enter to accept the selection.

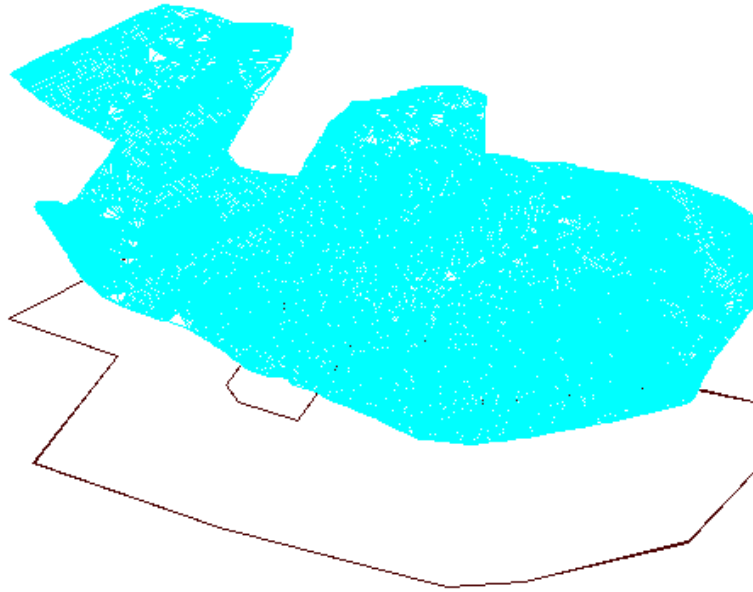

- 8 Click View tab ► Views panel  Visual Styles drop-down ► Realistic.
The gray scale Google Earth image appears draped over the surface. Notice that because the image was larger than the surface, the image has been clipped to the extents of the surface.

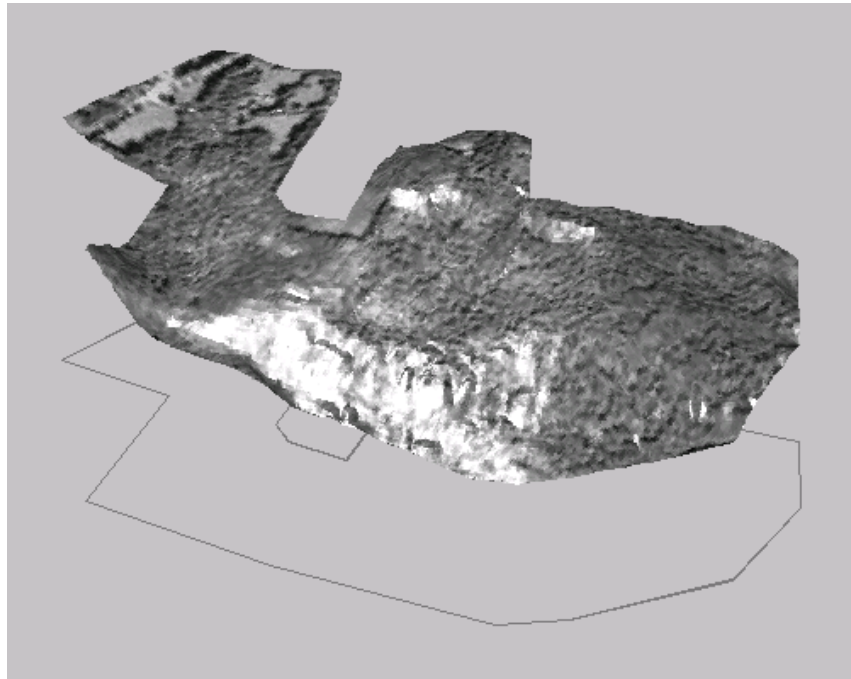

- 9 On the command line, enter Materials.
- 10 On the Materials palette, notice that a new render material has been created and is using the imported image as a diffuse map. The render material name and image name correspond to the names that you specified.

Survey Tutorials

6

These tutorials will get you started working with the AutoCAD Civil 3D survey features.

AutoCAD Civil 3D contains a complete set of tools that surveyors can use to download and process survey information, perform adjustments on network and traverse data, and import survey points into a AutoCAD Civil 3D drawing.

An easy-to-use wizard enables you to import survey data from various data sources, including points in the current drawing, and field book, LandXML, and point files. When the field crew codes survey points using a predetermined format, a linework code set can be used to process the linework quickly either during or after import.

The survey features also provide options for detailing points with figures and line work. Other options provide the capability of calculating directions based on astronomic observations.

For more information, see the AutoCAD Civil 3D Help topic *Understanding Survey*.

NOTE All drawings used in these tutorials are available in the [tutorial drawings folder](#) (page 819). If you want to save your work from these tutorials, save the drawings to the [My Civil Tutorial Data folder](#) (page 819) so that you do not overwrite the original drawings.

Tutorial: Survey Setup

This tutorial demonstrates how to access the survey functionality and define and manage the survey settings in AutoCAD Civil 3D.

In the following exercises, you will specify survey project settings by setting up a survey database, equipment definition, figure prefix database, individual user settings, survey styles, and linework code set.

For more information, see the AutoCAD Civil 3D Help topic *Survey Databases*.

Exercise 1: Creating a Survey Database

In this exercise, you will open the Survey tab in Toolspace, create a local survey database, and then open a drawing to display the survey data.

For more information, see the AutoCAD Civil 3D Help topic *Survey Databases*.

Create a survey database

- 1 Open *Survey-1.dwg*, which is located in the [tutorial drawings folder](#) (page 819).
- 2 Click Home tab ► Palettes panel ► Survey Toolspace .
- 3 In Toolspace, on the Survey tab, right-click Survey Databases. Click New Local Survey Database.
- 4 In the New Local Survey Database dialog box, enter Survey 1 for the database name. Click OK.

The newly created database is added to the Survey Databases collection on the Survey tab. Empty items that appear in the collection include Import Events, Networks, Figures, and Survey Points. These collections are populated when you add or create survey data.

To continue this tutorial, go to [Exercise 2: Setting the Equipment and Figure Prefix Databases](#) (page 130).

Exercise 2: Setting the Equipment and Figure Prefix Databases

In this exercise, you will create new survey equipment and figure prefix databases and definitions.

Equipment definitions specify the values associated with a specific surveying instrument, such as the standard deviations associated with the measuring capabilities of the instrument.

Figure prefixes specify the layer that a figure is drawn on, how a figure is stylized, and whether figures are created as breaklines and lot lines. When figures are created, they are matched based on their names and the prefix names. All figures that match a specific prefix are assigned the properties of the prefix.

For more information, see the AutoCAD Civil 3D Help topics *Survey Equipment Database* and *Survey Figure Prefix Database*.

This exercise continues from [Exercise 1: Creating a Survey Database](#) (page 130).

Create an equipment database

NOTE This exercise uses *Survey-1.dwg* with the modifications you made in the previous exercise.

- 1 In Toolspace, on the Survey tab, right-click the Equipment Databases collection. Click New.
- 2 In the New Equipment Database dialog box, enter Survey 1 for the new equipment database and click OK.

Create an equipment definition

- 1 Right-click the Survey 1 equipment database. Click Manage Equipment Database.
- 2 In the Equipment Database Manager - Survey 1 dialog box, under the Miscellaneous property, for Name, enter Survey 1.

NOTE The Standard Deviations settings determine the accuracy of the survey observations based on the equipment that measured them.

- 3 Click OK.
- 4 In Toolspace, on the Survey tab, right-click the Survey 1 equipment definition. Click Make Current.
In Toolspace, the current equipment database name is displayed in bold text.

Create a figure prefix database

- 1 In Toolspace, on the Survey tab, right-click the Figure Prefix Databases collection. Click New.
- 2 In the New Figure Prefix Database dialog box, enter Survey 1 for the new figure prefix database and click OK.

Create a figure prefix definition

- 1 In Toolspace, on the Survey tab, expand the Figure Prefix Databases collection. Right-click the figure prefix database Survey 1. Click Manage Figure Prefix Database.

- 2 In the Figure Prefix Database Manager dialog box, click .
- 3 Specify the following parameters:
 - Name: LOT
 - Lot Line: Selected
 - Site: Survey Site
All figures that match the LOT prefix name will have the Lot Line setting set to Yes. When the figure is inserted into the drawing, AutoCAD Civil 3D will create lot lines in the drawing in the Survey Site.
- 4 Click OK.
- 5 In Toolspace, on the Survey tab, right-click the Survey 1 figure prefix database. Click Make Current.

To continue this tutorial, go to [Exercise 3: Adjusting and Verifying Settings](#) (page 132).

Exercise 3: Adjusting and Verifying Settings

In this exercise, you will view and adjust several types of survey settings.

Survey user settings are specific to a Windows user login account and affect only the survey features, and not the database or drawing data.

Survey database settings are specific to the survey features of an AutoCAD Civil 3D survey database.

For more information, see the AutoCAD Civil 3D Help topic *Survey Settings*.

This exercise continues from [Exercise 2: Setting the Equipment and Figure Prefix Databases](#) (page 130).

Specify user settings

NOTE This exercise uses *Survey-1.dwg* with the modifications you made in the previous exercise.

- 1 In Toolspace, on the Survey tab, click .

2 In the Survey User Settings dialog box, specify the following parameters:

- Miscellaneous ► Use External Editor: Yes
- Network Preview: All Selected
- Setup Preview: All Selected
- Figure Preview: All Selected

Selecting the check boxes enables the previewing of all survey components in the Toolspace Survey tab.

3 Click OK.

Specify survey database settings

1 In Toolspace, on the Survey tab, in the Survey Databases collection, right-click the Survey 1 database. Click Edit Survey Database Settings.

2 In the Survey Database Settings dialog box, under Precision, specify the following parameters:

- Angle: 4
- Distance: 3
- Elevation: 3
- Coordinate: 4
- Latitude And Longitude: 8

These precision settings are independent of the Drawing Settings precision settings and affect all aspects of the user interface that displays the survey data.

3 Under Least Squares Analysis Defaults, specify the following parameters:

- Network Adjustment Type: 3-Dimensional
- Confidence Level: **99% confidence**
- Perform Blunder Detection: Yes

NOTE The Error Tolerance values specify the acceptable error values for the survey measurement. The values in this collection correspond to the units of measure that are specified in the Units collection. For more information, see the AutoCAD Civil 3D Help topic *Setting Error Tolerance*.

- 4 Click OK.

To continue this tutorial, go to [Exercise 4: Setting Survey Styles](#) (page 134).

Exercise 4: Setting Survey Styles

In this exercise, you will review the survey network styles and create a figure style.

The survey network and figure styles control the way that survey features are displayed in the drawing.

For more information, see the AutoCAD Civil 3D Help topic *Survey Styles and Display*.

This exercise continues from [Exercise 3: Adjusting and Verifying Settings](#) (page 132).

Review the network style settings

NOTE This exercise uses *Survey-1.dwg* with the modifications you made in the previous exercise.

- 1 In Toolspace, on the Settings tab, expand the Survey ► Network Styles collection.
This collection contains all the existing network styles in the drawing.
- 2 Right-click the Standard network style. Click Edit.
- 3 In the Network Style dialog box, click the Components tab.
Notice that you can set different marker styles for known control points, unknown control points, tolerance error points, and sideshot points.
- 4 Click OK.

Create a figure style

- 1 Right-click the Figure Styles collection. Click New.
- 2 In the Figure Style dialog box, on the Information tab, enter Building for the figure style name.
- 3 Click the Display tab.

- 4 In the Component Display table, change the color for the Figure Lines. To do this, click in the Color column. In the Select Color dialog box, in the Color field, enter 11. Click OK.
- 5 Click OK.

To continue this tutorial, go to [Exercise 5: Setting Up a Linework Code Set](#) (page 135).

Exercise 5: Setting Up a Linework Code Set

In this exercise, you will learn how to set up a linework code set to interpret the field codes that the survey field crew enters into a data collector.

When field-coded data is imported into AutoCAD Civil 3D, the linework code set interprets the syntax of simple field codes that are contained within survey point descriptions. The linework is connected between similar points. You will use a linework code set to define linework from imported survey data in the [Importing Field-Coded Survey Data](#) (page 136) exercise.

For more information, see the AutoCAD Civil 3D Help topic *Survey Field to Finish*.

This exercise continues from [Exercise 4: Setting Survey Styles](#) (page 134).

Examine the default linework code set

- 1 In Windows Explorer, navigate to the [tutorial folder](#) (page 820). Open *Survey-1.fbk* using a text editor.
- 2 In Windows Explorer, navigate to the [tutorial folder](#) (page 820). Open *Survey-X.fbk* using a text editor.
- 3 In the text editor, for *Survey-X.fbk*, highlight the 34th and 35th lines, which contain the following code:

```
BEGIN TC1
FC1 VA 105 19.192302 57.714      88.440647 "TC1"
```
- 4 In the text editor, for *Survey-1.fbk*, highlight the 24th line, which contains the following code:

```
FC1 VA 105 19.192302 57.714  88.440647 "TC1 B H0.5 H-0.1 V-0.5"
```
- 5 In Toolspace, on the Survey tab, expand the Linework Code Sets collection. Right-click Sample. Click Edit.

The field codes for the Sample linework code set are displayed in the Edit Linework Code Set dialog box. Each property has a user-definable code assigned to it. Compare the codes with the line you selected in the text editor.

The selected lines define the beginning of a top of curb figure:

- In *Survey-X.fbk*, the selected lines consist of the feature code (BEGIN TC1), FC1 VA 105 horizontal angle, slope distance, zenith angle, and description. The point description contains the raw point description (TC1) and XYZ coordinates.
- In *Survey-1.fbk*, the selected line contains information that is similar to *Survey-X.fbk*. Notice that horizontal and vertical offset values are also present. If you examine the remainder of the files, you will see that the format used by *Survey-1.fbk* is simpler and more flexible than *Survey-X.fbk*.

Compare the characters in *Survey-1.fbk* to the values in the Edit Linework Code Set dialog box. Under Special Codes, notice the codes that are defined for Begin, Horizontal Offset, and Vertical Offset. Each of these codes is displayed in the currently selected line. The current linework code set will interpret this survey point as being the beginning of the survey TC1 figure, with two horizontal offsets and one vertical offset.

- 6 Close the text editors and Edit Linework Code Set dialog box.

To continue to the next tutorial, go to [Importing Survey Data](#) (page 136).

Tutorial: Importing Survey Data

This tutorial demonstrates how to import survey data into a drawing, modify the data, and then reprocess the data.

You will input survey data from a field book file, which is a text file that contains survey observation measurements. Typically, you download data from a data collector, and then create a field book file to import.

For more information, see the AutoCAD Civil 3D Help topic *Understanding Survey*.

Exercise 1: Importing Field-Coded Survey Data

In this exercise, you will import survey data from an existing field book file that contains linework codes that can be interpreted by a linework code set.

The field book file that you will import contains the linework codes that you examined in the [Setting Up a Linework Code Set](#) (page 135) exercise.

For more information, see the AutoCAD Civil 3D Help topic *Importing Survey Data*[Importing Survey Data](#).

Set up the project

- 1 Open *Survey-2A.dwg*, which is located in the [tutorial drawings folder](#) (page 819)

This drawing is empty, but has point and figure styles that are appropriate for this exercise.

- 2 Click Home tab ► Create Ground Data panel ► Import Survey Data 

Create a survey database

- 1 In the Import Survey Data wizard, on the Specify Database page, under Survey Databases, select Survey 1.

If you need to create a survey database, you can click Create New Survey Database.

- 2 Click Edit Survey Database Settings.

You use the Survey Database Settings dialog box to define the parameters of the survey database. Notice that the settings match those you specified in the [Adjusting and Verifying Settings](#) (page 132) exercise.

- 3 Click OK.

- 4 Click Next.

Specify the file to import

- 1 On the Specify Data Source page, under Data Source Type, select Field Book File.

- 2 Under Source File, click .

- 3 In the Field Book Filename dialog box, navigate to the [tutorial folder](#) (page 820).

- 4 Select *Survey-1.fbk*. Click Open.

- 5 Click Next.

Create a survey network

- 1 On the Specify Network page, click Create New Network.
- 2 In the New Network dialog box, for Name, enter Survey Network 1.
- 3 Click OK.
- 4 Click Next.

Specify import options

- 1 On the Import Options page, specify the following parameters:
 - Current Equipment Database: Sample
 - Current Equipment: Sample
 - Show Interactive Graphics: Yes (Selected)
 - Current Figure Prefix Database: Sample
 - Process Linework During Import: Yes (Selected)
 - Current Linework Code Set: Sample
 - Process Linework Sequence: By Import Order
 - Assign Offset To Point Identifiers: Yes (Selected)
 - Point Identifier Offset: 10000
 - Insert Network Object: Yes (Selected)
 - Insert Figure Objects: Yes (Selected)
 - Insert Survey Points: Yes (Selected)

Accept the remaining default values.

- 2 Click Finish.
The survey data is imported, and the drawing looks like this:

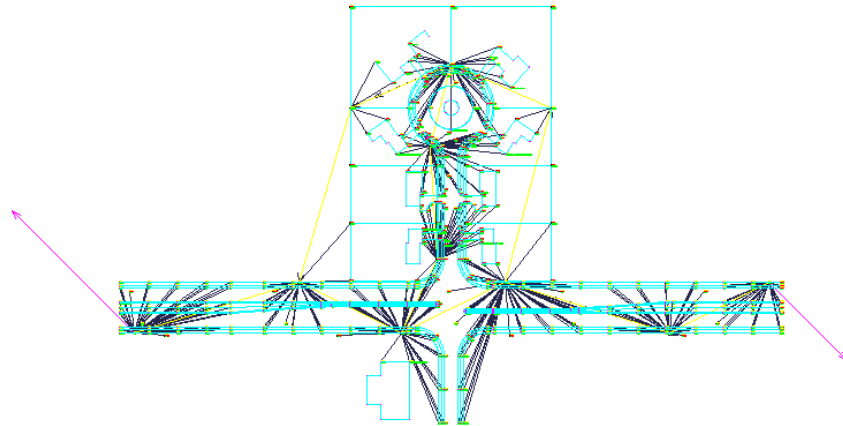

3 Click  Save As.

4 Navigate to the [My Civil Tutorial Data folder](#) (page 819). For File Name, enter Survey-2B.dwg. Click Save.

To continue this tutorial, go to [Exercise 2: Updating Imported Survey Data](#) (page 139).

Exercise 2: Updating Imported Survey Data

In this exercise, you will modify some of the imported survey data, and then reprocess the linework to apply the changes.

You will learn about import events, which are a reference to the original survey data file that was imported into the survey database. Import events are useful when you need to determine how the survey data was originally imported and the individual points and figures that were imported during that event. Import events provide a convenient way to remove, re-import, and reprocess the survey data referenced within the event.

For more information, see the AutoCAD Civil 3D Help topic *Import Events*.

Reprocess the survey points

NOTE This exercise uses *Survey-2B.dwg*, which you saved in the [My Civil Tutorial Data folder](#) (page 819) during the previous exercise. If you did not do this, you can use the copy of *Survey-2B.dwg* that is in the [tutorial drawings folder](#) (page 819), but you will get duplicate objects when you update the survey data.

- 1 In Toolspace, on the Survey tab, expand the Survey Databases ► Survey 1 ► Import Events collection.

NOTE If you cannot expand the collection, right-click the database name and click Open For Edit.

- 2 Select Import Events.
The import options that were specified when the survey data was imported are displayed in the Toolspace list view. Notice that Point Identifier Offset is 10000. This indicates that as each survey point was imported, 10000 was added to the original point number. You will remove this offset value in the following steps.
- 3 Under the Survey-1.fbk import event, select Survey Points.
In the Toolspace list view, compare the values in the Number column with the values in the Original Number column. The Number column reflects the offset of 10000 that was added to the point numbers when they were imported.
- 4 Right-click Survey-1.fbk. Click Re-Import.
- 5 In the Re-Import Field Book dialog box, clear the Assign Offset To Point Identifiers check box.
- 6 Click OK.

NOTE If you are prompted to abort the import process, click No.

The points are re-imported, and the linework is reprocessed.

Update and reprocess a survey figure

- 1 In Toolspace, on the Survey tab, select the Survey Databases ► Survey 1 ► Figures collection.
- 2 In the list view, select BLDG7. Right-click. Click Zoom To.

The BLDG7 figure is displayed in the drawing. The ending line segments are incorrect, and the figure is not closed. You will edit the survey point to correct the figure.

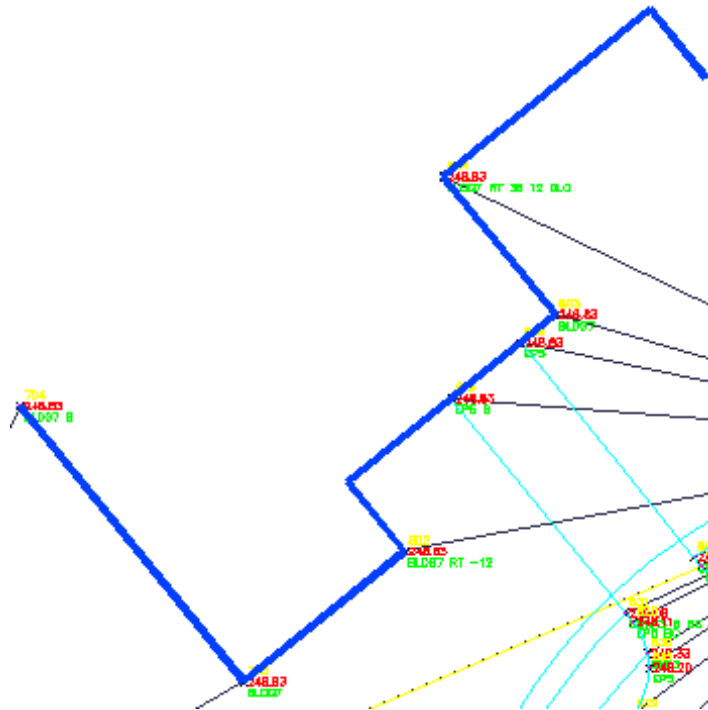

- 3 In the drawing, select survey point 804.

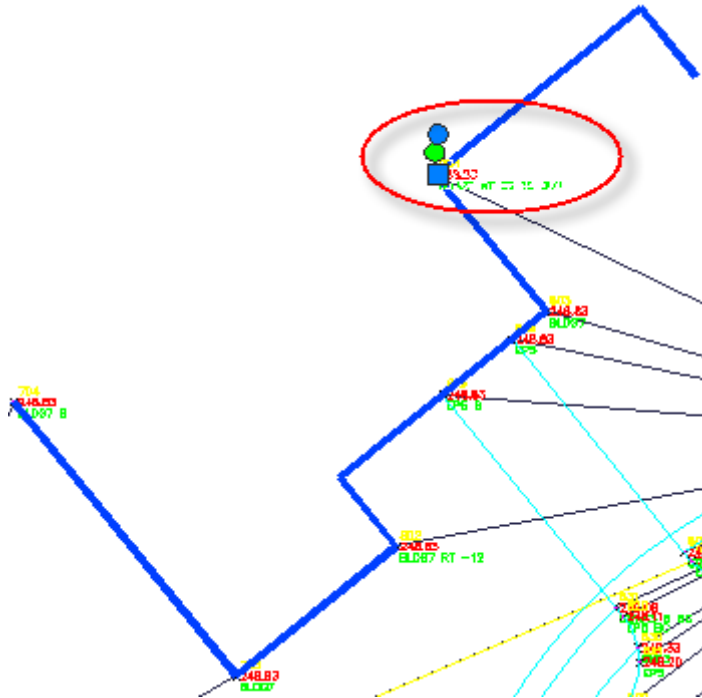

- 4 Click Survey Point tab ► Modify panel ► Survey Point Properties  .
In the Description, two errors are evident. First, a - (hyphen) was omitted from one of the values, which caused the line to extend in the wrong direction. Second, the close code is CLO, while the close code specified in the linework code set is CLS.
- 5 In the Survey Point Properties dialog box, change the Description to the following:
BLDG7 RT -36 12 CLS
- 6 Click OK.
You are prompted to select another survey point object. The command persists, so you can continue modifying survey point properties, as necessary.
- 7 Press Enter to end the command.
You are prompted to update the linework associated with the survey points.

NOTE All survey points must be reprocessed because any point potentially can contribute to the definition of any generated figure.

- 8 Click Yes.
- 9 In the Process Linework dialog box, clear the Insert Survey Points check box.

In this case, it is only necessary to update the figure linework. The point coordinates did not change.

- 10 Click OK.
The linework is reprocessed, and the survey figure is corrected.

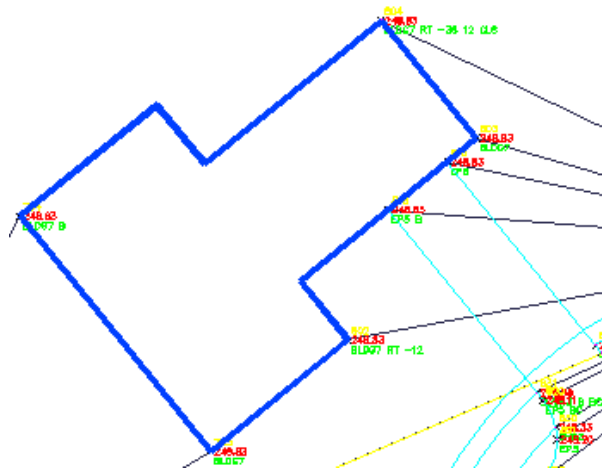

- 11 Click  Save As.
- 12 Navigate to the [My Civil Tutorial Data folder](#) (page 819). For File Name, enter Survey-3.dwg. Click Save.

To continue to the next tutorial, go to [Viewing and Editing Survey Data](#) (page 144).

Tutorial: Viewing and Editing Survey Data

This tutorial demonstrates how to view and modify survey data in your drawing.

NOTE Before performing the steps in this tutorial, you must have already set up the survey database. For more information, see the [Survey Setup](#) (page 129) tutorial.

You will use the Survey tab in Toolspace to view and manage survey data, such as points, setups, directions, and figures.

NOTE The Survey Data Collection Link extension can be used to transfer and convert raw data to an FBK file.

For more information, see the AutoCAD Civil 3D Help topic *Adding and Editing Survey Data*.

Exercise 1: Viewing Survey Data

In this exercise, you will use the Toolspace Survey tab and panorama vistas to view some of the data that you imported from the field book file.

You will also browse to the newly created network and figure objects in the AutoCAD Civil 3D Prospector tab and drawing.

For more information, see the AutoCAD Civil 3D Help topic *The Toolspace Survey Tab*.

View the survey data

NOTE This exercise uses *Survey-3.dwg*, which you saved in the [My Civil Tutorial Data folder](#) (page 819) during the previous exercise. If you did not do this, you can use the copy of *Survey-3.dwg* that is in the [tutorial drawings folder](#) (page 819), but you will get duplicate objects when you update the survey data.

- 1 In Toolspace, on the Survey tab, expand Survey Databases ► Survey 1 ► Networks ► Survey Network 1 to display the collections of survey data, including control points, directions, and setups.

NOTE If you cannot expand the collection, right-click the database name and click Open For Edit.

- 2 To view the control points, click the Control Points collection. The control points are displayed in the Toolspace list view.

NOTE By default, if the Toolspace is docked, the list view is the lower part of the Toolspace.

- 3 To view the setups, select the Setups collection.
The setups are displayed in the Toolspace list view.
- 4 To view observations for a setup, right-click the setup and click Edit Observations.
The Observations Editor vista is displayed with all the observations for the selected setup.

NOTE The observations for the setup are highlighted in the drawing.

- 5 Click  to close the Observations Editor.
- 6 To view the figures, select the Figures collection.
The figures are displayed in the Toolspace list view.
- 7 In Toolspace, click the Prospector tab and expand the Survey collection to display the collections of survey networks and figures.
These collections are for the survey network and figure drawing objects as opposed to the survey database data that is displayed on the Survey tab.

Browse to the survey data

- 1 To view a figure in the drawing, on the Prospector tab, expand the Figures collection, right-click the figure name, for example BLDG1, and click Zoom To.
The drawing zooms to the selected figure.
- 2 In the drawing, select the figure that you zoomed to. Right-click. Click Browse To Survey Data.
The Toolspace switches to the Survey tab with the figure selected. The survey data for the figure is displayed in the list view.

NOTE If you use the Survey-3.dwg that is in the [tutorial drawings folder](#) (page 819), you are notified that the associated survey database is not available. Click OK.

- In the drawing window, hover your cursor over one of the survey network components extending from BLDG1. Notice that the properties for the network object are displayed in the tooltip.

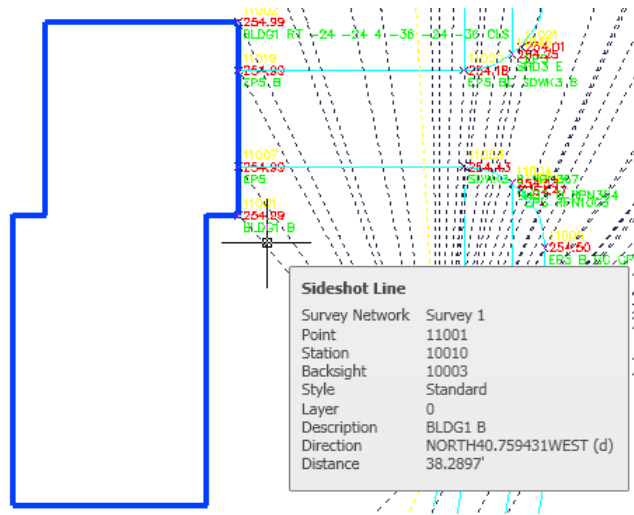

- Right-click the network object. Click Browse To Survey Network.
In Toolspace, on the Survey tab, the survey network is selected. The survey data for the survey network is displayed in the list view.
- Ctrl+click one of the survey network components shown in the previous image. Right-click. Click Browse To Survey Data.
The related setup is highlighted the Observations Editor vista.
- Click  to dismiss the Observations Editor vista.

To continue this tutorial, go to [Exercise 2: Editing a Figure](#) (page 146).



Exercise 2: Editing a Figure



In this exercise, you will edit a figure to change its display in the drawing. For more information, see the AutoCAD Civil 3D Help topic *Editing Figures*. This exercise continues from [Exercise 1: Viewing Survey Data](#) (page 144).

Edit a figure

NOTE This exercise uses *Survey-3.dwg* with the modifications you made in the previous exercise.

- 1 In Toolspace, on the Survey tab, expand the database Survey 1 to display the Figures collection.

NOTE If a  is displayed beside the Figures collection, click the collection to refresh it and then click  to view all the figures.

- 2 Right-click the Figures collection. Click Edit Figures.
- 3 In the Figures Editor vista, in the BLDG1 row, for Style, select Building. The entire row is displayed as bold. The bold row indicates that a change has been made to the figure data but it has not been saved to the survey database.
- 4 Click  to save the change to the survey database.
- 5 Click  to close the Figures Editor vista.
- 6 On the Toolspace Survey tab, in the list view, right-click the BLDG1 figure. Click Remove From Drawing. Click Yes. The figure is deleted from the drawing.
- 7 Right-click BLDG1 again and click Insert Into Drawing. The BLDG1 figure is displayed with the new style.

To continue to the next tutorial, go to [Analyzing and Reducing Survey Data](#) (page 147).

Tutorial: Analyzing and Reducing Survey Data

This tutorial demonstrates how to analyze and reduce survey data.

In the following exercises, you will use the Survey Command Window to query survey data. Then, you will look at two ways to reduce the survey data.

You can reduce survey data by:

- Adjusting a traverse loop using the standard compass rule method or other adjustment methods.

- Using the network least squares adjustment method.

Each method produces slightly different results. The standard compass rule adjustment method adjusts the traverse loop and sideshots. The least squares method adjusts each of the observations so that the sum of the residuals is at a minimum.

NOTE Before performing the steps in this tutorial, you must have already created the survey database Survey 1 and imported the field book file *Survey-1.fbk*. For more information, see the [Survey Setup](#) (page 129) and [Importing and Viewing Survey Data](#) (page 144) tutorials.

For more information, see the AutoCAD Civil 3D Help topic *Survey Analysis and Output*.

Exercise 1: Querying Survey Data

In this exercise, you will use the Survey Command Window to perform a query on the survey data.

You will use the Inverse Points command to determine the direction and distance between two points.

For more information, see the AutoCAD Civil 3D Help topic *Survey Command Window*.

This exercise continues from the [Importing and Viewing Survey Data](#) (page 144) tutorial.

Specify the survey database settings

- 1 Open *Survey-3.dwg*, which is located in the [tutorial drawings folder](#) (page 819)
This drawing contains the survey network that was created in the [Importing Field-Coded Survey Data](#) (page 136) exercise.
- 2 In Toolspace, on the Survey tab, expand the Survey Databases collection.
- 3 If the database Survey 1 is not open (that is, it is not displayed with a  next to it), right-click and click Open For Edit.

NOTE By default, to save on resource usage, when you start AutoCAD Civil 3D, all survey databases are displayed in a closed state.

- 4 Right-click Survey 1. Click Edit Survey Database Settings.
- 5 In the Survey Database Settings dialog box, expand the Survey Command Window property group. Specify the following parameters:
 - Point Course Echo: Yes
 - Figure Course Echo: Yes
 - Point Coordinate Echo: Yes
 - Figure Coordinate Echo: Yes
 - Command Echo: Yes

These settings determine what information will be displayed in the Survey Command Window.
- 6 Click OK.

Query data using the Survey Command Window

- 1 On the Survey tab, expand the Networks collection. Right-click Survey Network 1. Click Survey Command Window.
- 2 In the Survey Command Window, click View menu ► Zoom To Point.
- 3 In the Enter Point dialog box, enter 1. Click OK.
The drawing zooms to point 1.
- 4 Click Point Information menu ► Inverse Points.
- 5 In the Point Information - Inverse Points dialog box, enter:
 - Start Point: 1
 - Ahead Point: 2
- 6 Click OK.

The following information, which describes the location of each point and the direction and distance between the points, is displayed in the command output area:

```
!
! POINT 1      NORTH: 5000.0000      EAST: 5000.0000      EL:
263.6500
!
! Distance: 300.000      Course: N 72-56-33 E
!
```

! POINT 2 NORTH: 5087.9995 EAST: 5286.8036 EL:
259.9600

7 Close the Survey Command Window.

To continue this tutorial, go to [Exercise 2: Performing Traverse Analysis](#) (page 150).

Exercise 2: Performing Traverse Analysis

In this exercise, you will reduce some of the survey data using the traverse analysis Compass Rule adjustment method.

The Compass Rule is a method of corrections. It assumes that the closing errors are as much due to errors in observed angles as by the errors in measured distances. The closing errors in latitude and departure are distributed according to the ratio of the length of the line to the total length of the traverse.

For more information, see the AutoCAD Civil 3D Help topic *Traverses*.

This exercise continues from [Exercise 1: Querying Survey Data](#) (page 148).

Set up a traverse

NOTE This exercise uses *Survey-3.dwg* with the modifications you made in the previous exercise.

- 1 In Toolspace, on the Survey tab, expand the Survey Databases ► Survey 1 ► Networks ► Survey Network 1. Right-click the Traverses collection. Click New.
- 2 In the New Traverse dialog box, for Name, enter Traverse 1. Click OK.
- 3 On the Survey tab, in the list view, right-click Traverse 1, and click Properties.
- 4 In the Traverse Properties dialog box, specify the following parameters:
 - Initial Station: 1
 - Initial Backsight: 1000
 - Stations: 2,3,4,5,6
 - Final Foresight: 6000
- 5 Click OK.

Run a traverse analysis

- 1 On the Survey tab, in the list view, right-click Traverse 1. Click Traverse Analysis.
- 2 In the Traverse Analysis dialog box, specify the following parameters:
 - Horizontal Adjustment Method: Compass Rule
 - Vertical Adjustment Method: Length Weighted Distribution
Use the default values for the other properties.
- 3 Click OK.

The analysis runs, and the following files are displayed in the ASCII text editor:

- *Traverse 1 Raw Closure.trv*: Displays the horizontal closure and angular error.
 - *Traverse 1 Vertical Adjustment.trv*: Displays a report of raw and adjusted elevations from the vertical adjustment methods.
 - *Traverse 1 Balanced Angles.trv*: Displays the adjusted station coordinates derived from balancing the angular error and horizontal closure with no angular error.
 - *Traverse 1.iso*: Displays the adjusted station coordinates based on the Horizontal Adjustment Type setting (Compass Rule).
- 4 Close all the text files.
A dialog box notifies you that you should use the Process Linework command to update the figures with the new traverse information. Reprocessing the survey linework is a manual process. You will see how to update the linework in the following steps.
 - 5 In the Survey Network Updated dialog box, click Close.
 - 6 In Toolspace, on the Survey tab, under Import Events, right-click Survey-1.fbk. Click Process Linework.

The Process Linework dialog box enables you to reprocess the survey network linework connectivity after you make corrections to the survey data.

When the survey database is updated following a traverse analysis, the following adjustments to the data that references the traverse take place:

- Observed station points are updated and added to the Control Points collection.

- All sides shots from adjusted setups within the traverse are updated.
- All figures that reference points within the traverse are updated.
- Any of the above data that is displayed in the current drawing is also updated.

Because you will use this survey database to perform other analyses in later exercises, you will not reprocess the linework.

- 7 Click Cancel.
- 8 In Toolspace, on the Survey tab, select the Control Points collection. Right-click. Click Reset Adjusted Coordinates.
This action resets the adjusted coordinates, enabling you to continue with the next analysis.

To continue this tutorial, go to [Exercise 3: Performing Least Squares Analysis](#) (page 152).

Exercise 3: Performing Least Squares Analysis

In this exercise, you will reduce the survey information using the least squares adjustment method.

The least squares method calculates the most probable value for each observation. The values are calculated by adjusting each of the observations simultaneously so that the sum of the squares of the residuals (the difference between measured and adjusted observations) is at a minimum.

For more information, see the AutoCAD Civil 3D Help topic *Least Squares Analysis*.

This exercise continues from [Exercise 2: Performing Traverse Analysis](#) (page 150).

Modify the survey network style

NOTE This exercise uses *Survey-3.dwg* with the modifications you made in the previous exercise.

- 1 In Toolspace, on the Settings tab, expand the Survey ► Network Styles collection.
This collection contains the existing network styles in the drawing.

- 2 Right-click the Standard network style. Click Edit.
- 3 In the Network Style dialog box, click the Components tab.
- 4 Under Error Ellipse, set the Error Ellipse Scale Factor to 10000.00.
- 5 Click OK.

Run the least squares analysis

- 1 In Toolspace, on the Survey tab, expand the Survey Databases ► Survey 1 ► Networks collection. Right-click the network Survey Network 1. Click Least Squares Analysis ► Perform Analysis.
- 2 In the Least Squares Analysis dialog box, under Input, specify the following parameters:
 - Create Input File: Selected
 - Input File Name: Survey Network 1
 - Network Adjustment Type: 3-DimensionalUse the default values for the other settings.
- 3 Click OK. If prompted, click Yes to overwrite the existing Network File. The analysis runs, the network and drawing updates, and the following files are displayed in the ASCII text editor:
 - <survey network>.lsi: Displays the initial station coordinates and elevations. The angle and distance information for each station, as well as the standard errors for angles and distances are also displayed.
 - <survey network>.lso: Displays the results of the calculations as well as the adjusted coordinate information.
- 4 When you have finished reviewing the least squares calculation data, close the text files.
- 5 To view an error ellipse, on the Survey tab, select the Survey Network 1 ► Control Points collection. In the list view, right-click 2. Click Zoom To.
The drawing zooms to the point and ellipse.

To continue this tutorial, go to [Exercise 4: Translating a Survey Database](#) (page 154).

Exercise 4: Translating a Survey Database

In this exercise, you will translate the contents of a survey database from assumed coordinates to that of known coordinates.

This command is useful when you must move all the data in the survey database from an assumed location to a known location.

For more information, see the AutoCAD Civil 3D Help topic *Translating a Survey Database*.

This exercise continues from [Exercise 3: Performing Least Squares Analysis](#) (page 152).

Examine the contents of a survey database

NOTE This exercise uses *Survey-3.dwg* with the modifications you made in the previous exercise.

- 1 In Toolspace, on the Survey tab, expand the Survey Databases ► Survey 1 ► Networks ► Survey Network 1 collections.
- 2 Click the Setups collection.
In the list view, examine the elevation values of the following setups:
 - Station Point 1, Backsight Point 1000: Instrument Elevation = 263.650
 - Station Point 2, Backsight Point 1: Instrument Elevation = 259.960
 - Station Point 3, Backsight Point 2: Instrument Elevation = 257.438

For this exercise, you will assume that the elevation value for Station Point 1, Backsight Point 1000, which is at Easting 5000 and Northing 5000, is 2.25 greater than the actual elevation.

Translate the survey database

- 1 In Toolspace, on the Survey tab, select the Survey 1 database. Right-click. Click Translate Survey Database.
- 2 In the Translate Survey Database wizard, on the Base Point page, specify the following parameters:
 - Easting: 5000
 - Northing: 5000

On this page, you specify the base point from which the survey network will be moved.

3 Click Next.

On the Rotation Angle page, you specify the base point from which the survey network will be moved. For this exercise, you will not change the rotation of the survey network.

4 On the Rotation Angle page, for Rotation Angle, enter 0.

5 Click Next.

On the Destination Point page, you specify the point to which the survey network will be moved. Notice that you can specify a new Easting, Northing, or Elevation Change value. In this exercise, you will change only the elevation.

6 On the Destination Point page, for Elevation Change, enter -2.25.

7 Click Next.

On the Summary page, you can examine the results of the translation before it is applied to the survey network. If you want to modify the translation, you can use the Back button to return to previous pages on the wizard.

8 Click Finish.

9 In Toolspace, on the Survey tab, click the Setups collection.

In the list view, examine the elevation values of the setups that you examined in Step 2. Notice that the values have been decreased by 2.25.

- Station Point 1, Backsight Point 1000: Instrument Elevation = 261.400
- Station Point 2, Backsight Point 1: Instrument Elevation = 257.710
- Station Point 3, Backsight Point 2: Instrument Elevation = 255.188

To continue to the next tutorial, go to [Manually Creating Survey Data](#) (page 155).

Tutorial: Manually Creating Survey Data

This tutorial demonstrates how to manually create and add survey data.

In the following exercises, you will use three different methods to create survey data:

- The Toolspace Survey tab collections and commands
- The Traverse Editor
- The Survey Command Window commands

You will also learn how to calculate an azimuth using the astronomic direction calculator, as well as how to create figures from Civil 3D parcels.

For more information, see the AutoCAD Civil 3D Help topic *Adding and Editing Survey Data*.

Exercise 1: Creating Survey Data Using the Toolspace Survey Tab

In this exercise, you will use the Toolspace Survey tab to create survey data.

The Survey tab provides centralized access to survey data, settings, and various panorama vista editors, which can be used to create, edit, and manage survey data.

For more information, see the AutoCAD Civil 3D Help topic *The Toolspace Survey Tab*.

Create a new survey database

- 1 Open *Survey-4A.dwg*, which is located in the [tutorial drawings folder](#) (page 819).
- 2 In Toolspace, on the Survey tab, right-click Survey Databases. Click New Local Survey Database.
- 3 In the New Local Survey Database dialog box, for the name, enter Survey 2. Click OK.
- 4 In Toolspace, on the Survey tab, right-click the database Survey 2. Click Edit Survey Database Settings.
- 5 In the Survey Database Settings dialog box, under Measurement Type Defaults, specify the following parameters:
 - Angle Type: Angle
 - Distance Type: Horizontal

- Vertical Type: None
- Target Type: None

6 Click OK.

Create a survey network

- 1 In Toolspace, on the Survey tab, expand the Survey 2 database. Right-click the Networks collection. Click New.
- 2 In the Network dialog box, for Name, enter Survey Network 2.
- 3 Click OK.

Create a control point

- 1 On the Survey tab, expand Survey Network 2. Right-click the Control Points collection. Click New.
- 2 In the New Control Point dialog box, specify the following parameters:
 - Number: 1
 - Easting: 1000.0000
 - Northing: 1000.0000
 - Description: STA 1
- 3 Click OK.

Create a direction

- 1 On the Survey tab, under Survey Network 2, right-click the Directions collection. Click New.
- 2 In the New Direction dialog box, specify the following parameters:
 - From Point: 1
 - To Point: 4
 - Direction: 45.0000
 - Direction Type: Azimuth
- 3 Click OK.

Create setups and observations

- 1 On the Survey tab, under Survey Network 2, right-click the Setups collection. Click New.
- 2 In the New Setup dialog box, specify the following parameters:
 - Station Point: 1
 - Backsight Point: 4
- 3 Press Tab to move to the next field.
A dialog box is displayed indicating that point 4 is not defined.
- 4 Click No, and then click OK to create the setup.
- 5 On the Survey tab, under Survey Network 2, select the Setups collection. In the list view, right-click the setup Station: 1, Backsight: 4. Click Edit Observations.
- 6 In the Observations Editor, right-click in the grid. Click New.
- 7 For the new observation, specify the following parameters:
 - Point Number: 2
 - Angle: 90.0000
 - Distance: 100.00

NOTE After you enter the Distance value, you must click  .

- Description: STA 2
- 8 Click  to save the new observation.
 - 9 On the Survey tab, under Survey Network 2, right-click the Setups collection. Click New.
 - 10 In the New Setup dialog box, specify the following parameters:
 - Station Point: 2
 - Backsight Point: 1
 - 11 Click OK.
 - 12 On the Survey tab, under Survey Network 2, expand the Setups collection. Right-click the setup Station: 2, Backsight: 1. Click Edit Observations.

13 In the Observations Editor, right click in the grid. Click New.

14 For the new observation, specify the following parameters:

- Point Number: 3
- Angle: 90.0000
- Distance: 100.00

NOTE After you enter the Distance value, you must click  .

- Description: STA 3

15 Click  to save the new observation.

16 Follow steps 9 through 15 to create another setup with an observation.

Information for the new setup:

- Station Point: 3
- Backsight Point: 2

Information for the new observation:

- Point Number: 4
- Angle: 90.0000
- Distance: 100.00

NOTE After you enter the Distance value, you must click  .

- Description: STA 4

17 Follow steps 9 through 15 to create another setup with an observation.

Information for the new setup:

- Station Point: 4
- Backsight Point: 3

Information for the new observation:

- Point Number: 1
- Angle: 90.0000

■ Distance: 100.00

- 18** On the Survey tab, right-click Survey Network 2. Click Insert Into Drawing. The new survey data is displayed in the drawing.

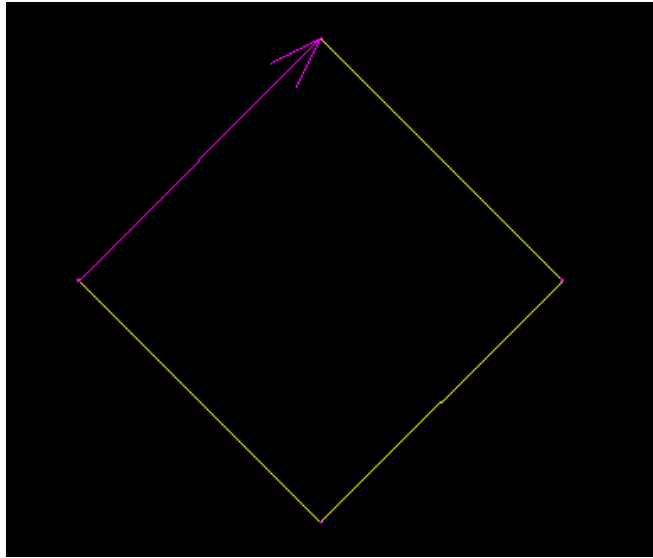

To continue this tutorial, go to [Exercise 2: Creating Survey Data Using the Traverse Editor](#) (page 160).

Exercise 2: Creating Survey Data Using the Traverse Editor

In this exercise, you will use the Traverse Editor to create survey data.

The Traverse Editor is used to edit the observations of an existing named traverse or to enter traverse observations for a new traverse.

For more information, see the AutoCAD Civil 3D Help topic *Traverses*.

This exercise continues from [Exercise 1: Creating Survey Data Using the Toolspace Survey Tab](#) (page 156).

Create a new survey database

- 1 Open *Survey-4B.dwg*, which is located in the [tutorial drawings folder](#) (page 819).
- 2 In Toolspace, on the Survey tab, right-click Survey Databases. Click New Local Survey Database.
- 3 In the New Local Survey Database dialog box, for the name, enter Survey 3. Click OK.
- 4 In Toolspace, on the Survey tab, right-click the database Survey 3. Click Edit Survey Database Settings.
- 5 In the Survey Database Settings dialog box, under Measurement Type Defaults, specify the following parameters:
 - Angle Type: Angle
 - Distance Type: Horizontal
 - Vertical Type: None
 - Target Type: None
- 6 Click OK.

Create a survey network

- 1 In Toolspace, on the Survey tab, expand the Survey 3 database. Right-click the Networks collection. Click New.
- 2 In the Network dialog box, for Name, enter Survey Network 3.
- 3 Click OK.

Set up a traverse and define control points

- 1 In Toolspace, on the Survey tab, expand the Survey Databases ► Survey 3 ► Networks ► Survey Network 3. Right-click the Traverses collection. Click New.
- 2 In the New Traverse dialog box, for Name, enter Traverse 3. Click OK.
- 3 On the Survey tab, select the Traverses collection. In the list view, right-click Traverse 3. Click Edit Traverse.
- 4 In the Specify Initial Setup dialog box, specify the following parameters:
 - Initial Station: 1

- Initial Backsight: 4
- 5 Click OK.
 - 6 A message is displayed indicating that initial station point 1 is not defined. Click Yes to define it.
 - 7 In the New Control Point dialog box, specify the following parameters:
 - Point Number: 1
 - Easting: 1000
 - Northing: 1000
 - Description: STA 1
 - 8 Click OK.
 - 9 A message is displayed indicating that backsight point 4 is not defined. Click Yes to define it.
 - 10 A message is displayed indicating that a backsight direction must be created. Click Yes to create it.
 - 11 In the New Direction dialog box, specify the following parameters:
 - Direction: 45
 - Direction Type: Azimuth
 - 12 Click OK.
The Traverse Editor is displayed.
 - 13 In the right side of the editor, for Station 1, Backsight 4, specify the following parameters:
 -  (point number): 2
 - Angle: 90
 - Distance: 100

NOTE After you enter the Distance value, you must click  .

 - Description: STA 2

14 For Station 2, Backsight 1, specify the following parameters:

-  (point number): 3
- Angle: 90
- Distance: 100

NOTE After you enter the Distance value, you must click  .

- Description: STA 3

15 For Station 3, Backsight 2, specify the following parameters:

-  (point number): 4
- Angle: 90
- Distance: 100
- Description: STA 4

16 For Station 4, Backsight 3, specify the following parameters:

-  (point number): 1
- Angle: 90
- Distance: 100

17 Click  to save the traverse information.

18 On the Survey tab, right-click Survey Network 3 and click Insert Into Drawing.

The new survey data is displayed in the drawing.

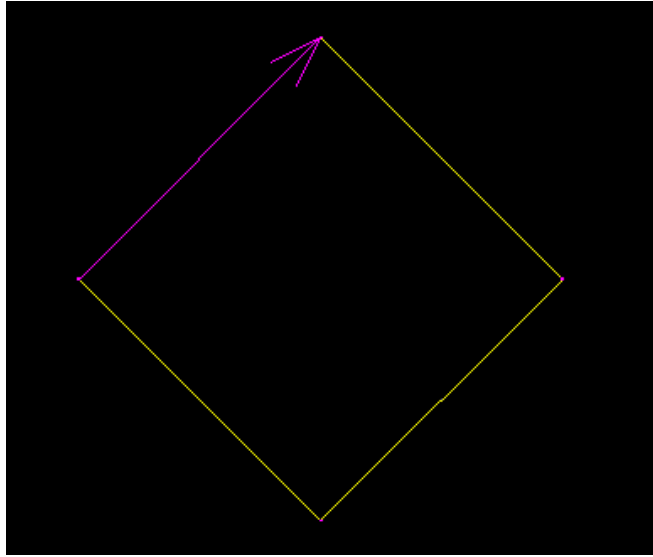

To continue this tutorial, go to [Exercise 3: Creating Survey Data Using the Survey Command Window](#) (page 164).

Exercise 3: Creating Survey Data Using the Survey Command Window

In this exercise, you will create survey data using the Survey Command Window.

The Survey Command Window is used to enter survey commands directly using Command line input or interactively using the menus.

For more information, see the AutoCAD Civil 3D Help topic *Survey Command Window*.

This exercise continues from [Exercise 2: Creating Survey Data Using the Traverse Editor](#) (page 160).

Create a new survey database

- 1 Open *Survey-4C.dwg*, which is located in the [tutorial drawings folder](#) (page 819).

- 2 In Toolspace, on the Survey tab, right-click Survey Databases. Click New Local Survey Database.
- 3 In the New Local Survey Database dialog box, for the name, enter Survey 4. Click OK.
- 4 In Toolspace, on the Survey tab, right-click the database Survey 4. Click Edit Survey Database Settings.
- 5 In the Survey Database Settings dialog box, under Survey Command Window, specify the following parameters:
 - Ditto Feature: Yes
 - Auto Point Numbering: No
 - Start Point Numbering From: 1
 - Point Course Echo: Yes
 - Figure Course Echo: Yes
 - Point Coordinate Echo: Yes
 - Figure Coordinate Echo: Yes
 - Command Echo: Yes
 - Use Batch File: Yes
 - Use Output File: Yes
- 6 Click OK.

Create a survey network

- 1 In Toolspace, on the Survey tab, expand the Survey 4 database. Right-click the Networks collection. Click New.
- 2 In the Network dialog box, for Name, enter Survey Network 4.
- 3 Click OK.

Enter survey data into the survey command window

- 1 In Toolspace, on the Survey tab, right-click Survey Network 4. Click Survey Command Window.
- 2 In the Survey Command Window, enter the following commands into the Command line.

These are the survey language commands that will create four setups.

```
NE 1 1000.00 1000.00 "STA 1"  
AZ 1 4 45.0000  
STN 1  
BS 4  
AD 2 90.0000 100.00 "STA 2"  
STN 2  
BS 1  
AD 3 90.0000 100.00 "STA 3"  
STN 3  
BS 2  
AD 4 90.0000 100.00 "STA 4"  
STN 4  
BS 3  
AD 1 90.0000 100.00
```

For more information about survey commands, see the AutoCAD Civil 3D Help topic *Survey Command Language Commands*.

- 3 As you enter the commands, the top section of the Survey Command Window displays the resulting output and the bottom section echoes the input.
- 4 Close the Survey Command Window.
- 5 On the Survey tab, right-click Survey Network 4 and click Insert Into Drawing.
The new survey data is displayed in the drawing.

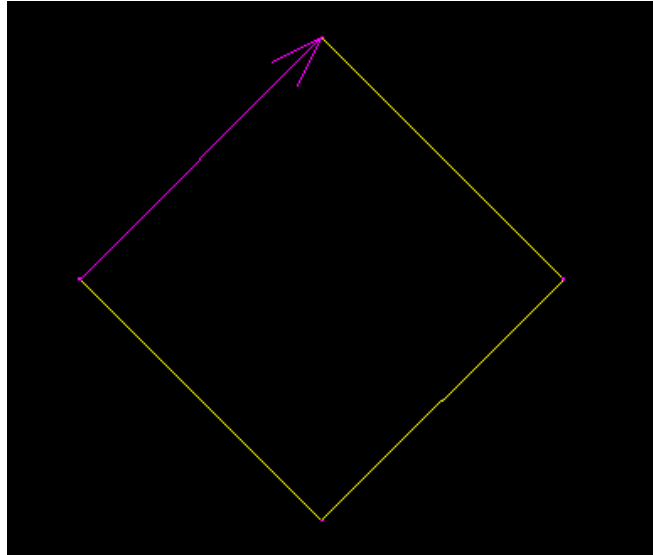

To continue this tutorial, go to [Exercise 4: Calculating an Azimuth in The Astronomic Direction Calculator](#) (page 167).

Exercise 4: Calculating an Azimuth in The Astronomic Direction Calculator

In this exercise, you will use the Astronomic Direction Calculator to calculate an azimuth from solar observations by the hour angle method.

To calculate the azimuth, you can use either a single foresight or a multiple foresight. For this exercise, you will use a multiple foresight because it is the more commonly used solar observation method.

For more information, see the AutoCAD Civil 3D Help topic *Astronomic Direction Calculations*.

This exercise continues from [Exercise 3: Creating Survey Data Using the Survey Command Window](#) (page 164).

Calculate an azimuth using the Astronomic Direction Calculator

NOTE This exercise uses *Survey-4C.dwg* with the modifications you made in the previous exercise.

- 1 Click Analyze tab ► Ground Data panel ► Survey drop-down ► Astronomic Direction .
- 2 In the Astronomic Direction Calculator dialog box, specify the following parameters:

Calculation Type

- Calculation Type: Sun Shot Calculation

Observation Station Data

- Station Point: 2
- Backsight Point: 1
- Station Latitude: 36.04
- Station Longitude: -94.1008
- UT1 Time: 13.34024

Ephemeris Data

- GHA 00 Hours: 180.13402
- GHA 24 Hours: 180.10431
- Declination 00 Hours: 22.54505
- Declination 24 Hours: 22.59437
- Sun Semi-diameter: 0.15468

- 3 Click .
- A new observation set named Set:1 is displayed in the table.
- 4 Specify the following parameters for Set:1:

Direct

- Backsight Observation: 0.00
- Sun Observation: 351.0835
- Stop Time: 0.121590

Reverse

- Backsight Observation: 180.0005
- Sun Observation: 171.3520
- Stop Time: 0.154210

NOTE The observations will determine the true astronomic direction from the station point to the backsight point. Notice that after you enter the stop time for an observation, the observed and average direction are calculated automatically.

5 Click .

A new observation set named Set:2 is displayed in the table.

6 Specify the following parameters for Set:2:

Direct

- Backsight Observation: 0.00
- Sun Observation: 351.1300
- Stop Time: 0.12491

Reverse

- Backsight Observation: 180.0005
- Sun Observation: 171.3800
- Stop Time: 0.16030

7 Click .

A new observation set named Set:3 is displayed in the table.

8 Specify the following parameters for Set:3:

Direct

- Backsight Observation: 0.00
- Sun Observation: 351.1450
- Stop Time: 0.13112

Reverse

- Backsight Observation: 180.0005
- Sun Observation: 171.4145
- Stop Time: 0.16313

After you have entered the above data, notice that the Mean Direction value calculated by the Astronomic Direction Calculator is SOUTH87.967088EAST (if the drawing settings Direction Measurement Type is set to Bearings).

9 Close the Astronomic Direction Calculator.

To continue this tutorial, go to [Exercise 5: Creating Figures from Parcels](#) (page 170).

Exercise 5: Creating Figures from Parcels

In this exercise, you will use AutoCAD Civil 3D parcel objects to add figures to a survey database.

In addition to parcel objects, you can also use feature lines, lot lines, and AutoCAD lines and polylines as a source to create figures.

For more information, see the AutoCAD Civil 3D Help topic *Creating Figures*.

This exercise continues from [Exercise 4: Calculating an Azimuth in The Astronomic Direction Calculator](#) (page 167).

Create a new survey database

- 1 Open *Survey-4D.dwg*, which is located in the [tutorial drawings folder](#) (page 819).

- 2 In Toolspace, on the Survey tab, right-click Survey Databases. Click New Local Survey Database.
- 3 In the New Local Survey Database dialog box, for the name, enter Survey 5. Click OK.

Create survey figures from existing parcels

- 1 In Toolspace, on the Survey tab, expand the database Survey 5. Right-click the Figures collection. Click Create Figure From Object.
- 2 In the drawing, click the label for the parcel SINGLE-FAMILY: 101.
- 3 In the Create Figure From Objects dialog box, specify the following parameters:
 - Name: LOT CORNER
 - Current Figure Prefix Database: Sample
 - Associate Survey Points To Vertices: Yes
- 4 Click OK.
- 5 Press Esc to end the command.

The figure is created and added to the survey database. Information about the figure is displayed in list view.

To continue to the next tutorial, go to [Outputting Survey Information](#) (page 171).

Tutorial: Outputting Survey Information

This tutorial demonstrates how to view information reports for figures and how to use the figures as a source for surface data.

For more information, see the AutoCAD Civil 3D Help topics *Figure Inquiry Commands* and *Creating Breaklines from Figures*.

Exercise 1: Viewing Inverse and Mapcheck Information on a Survey Figure

In this exercise, you will display the figure mapcheck and inverse information.

The Mapcheck command checks the figure for length, course, perimeter, area, error of closure, and precision. It starts at the beginning of the figure and computes the figure vertex XY coordinates for each segment. These computations are based on the inverse direction and distance/curve data and the Linear and Angle precision (set in the Survey Database Settings).

For closed figures, error is introduced into the sequential computation of vertices of the mapcheck report, so a closure error, closure direction, and precision can be calculated. The area is also based on the computed vertex XY coordinates.



The Inverse command starts at the beginning of the figure and lists the direction and distance, or curve data computed from the XY coordinates of the endpoints of the figure segments. The area is calculated from the XY coordinates of each segment.



For more information, see the AutoCAD Civil 3D Help topic *Figure Inquiry Commands*.

This exercise continues from the [Manually Creating Survey Data](#) (page 155) tutorial.

View inverse information for a figure

- 1 Open *Survey-5A.dwg*, which is located in the [tutorial drawings folder](#) (page 819).
This drawing contains the survey network that was created in the [Importing Field-Coded Survey Data](#) (page 136) exercise.
- 2 In Toolspace, on the Survey tab, right-click the database Survey 1. Click Open For Edit.
- 3 Under Survey 1, select the Figures collections.

NOTE If a  is displayed beside the Figures collection, click the collection to refresh it and then click  to view all the figures.

- 4 Right-click the figure BLDG2. Click Display Inverse.
The figure inverse information is displayed in the Figure Display vista.
The  icon indicates that a vertex is associated with a survey point.
- 5 When you have finished reviewing the inverse data, click  to close the vista.

View mapcheck information for a figure

- 1 In the list view, right-click a figure. Click Display Mapcheck.
The figure mapcheck information is displayed in the Figure Display vista.
- 2 When you have finished reviewing the mapcheck data, click  to close the vista.

To continue this tutorial, go to [Exercise 2: Performing a Mapcheck Analysis with Parcel Labels](#) (page 173).

Exercise 2: Performing a Mapcheck Analysis with Parcel Labels

In this exercise, you will use the data in parcel segment labels to perform a mapcheck analysis.

The Mapcheck command checks the figure for length, course, perimeter, area, error of closure, and precision. It starts at the beginning of the figure and computes the figure vertex XY coordinates for each segment. These computations are based on the actual labeled values, and not the inverse direction and distance/curve data and the Linear and Angle precision (set in the Survey Database Settings).



This method of performing a mapcheck analysis is useful as a final check of closure. The data for the mapcheck analysis is taken from parcel segment labels. The precision of the mapcheck analysis is based on the precision of the labels.

For more information, see the AutoCAD Civil 3D Help topic *Performing a Mapcheck Analysis*.

This exercise continues from [Exercise 1: Viewing Inverse and Mapcheck Information on a Survey Figure](#) (page 171).

Set up the mapcheck analysis dialog box

- 1 Open *Survey-5B.dwg*, which is located in the [tutorial drawings folder](#) (page 819).
This drawing contains a small subdivision with several parcels. All the parcel segments on the left side of the site are labeled. Notice that along the cul-de-sac, the line and curve labels have been converted to tags, and their data is displayed in a table on the left side of the site. You will perform a mapcheck analysis on parcel LOT 5.

- 2 Click Analyze tab ► Ground Data panel ► Survey drop-down ► Mapcheck .
- 3 If a message that states that the command line mode cannot be used while a command is active is displayed, click OK.
- 4 In the Mapcheck Analysis dialog box, make sure that the  Use Command Line Interface option is toggled on.
- 5 Click  Input View.
The input view provides an interface in which you can add data to the mapcheck analysis.

Perform a mapcheck on parcel labels

- 1 Click  New Mapcheck.
- 2 On the command line, for the name of the mapcheck, enter Parcel Labels.
- 3 When prompted to specify a point of beginning, click the intersection of the lot lines under label tag L1.





The  icon indicates the point of beginning.

- 4 Select the L1 label tag above the point of beginning.
A temporary arrow graphic is displayed at the point of beginning. Notice that the arrow is pointing away from LOT 5.
- 5 On the command line, enter R to reverse the direction of the arrow.
- 6 Select the C1 label tag.
Notice that the temporary line and arrow are pointing in the wrong direction.
- 7 Enter F to flip the arrow.
- 8 Select the C2 label tag.
- 9 Select the bearing over distance label to the left of the arrow. Enter R to reverse the direction.
- 10 Select the 100.00' portion of the bearing over distance label below the arrow.

A  icon appears at the end of the current line, and the command line states that there is not enough data to define the segment. This happened because the current segment is a lot line that is shared by all the parcels on the left side of the site.

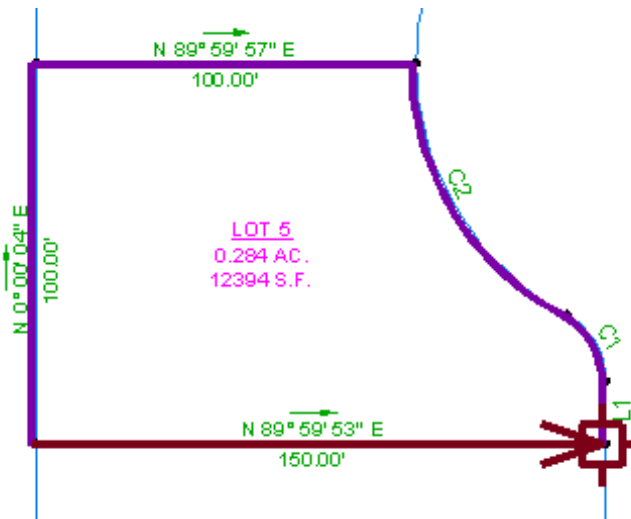
- 11 Select the bearing portion of the label. Enter R to reverse the direction.
- 12 Select the bearing over distance label to the right of the arrow.
The arrow returns to the point of beginning.



- 13 Press Enter to end the command.
In the Mapcheck Analysis dialog box, notice that you can edit any of the sides you created during the mapcheck analysis.
- 14 Click  Output View.
The Output View displays the results of the mapcheck analysis. You will learn how to work with the output data in [Exercise 4: Working with Mapcheck Data](#) (page 179).

To continue this tutorial, go to [Exercise 3: Performing a Mapcheck Analysis by Manually Entering Data](#) (page 176).

Exercise 3: Performing a Mapcheck Analysis by Manually Entering Data

In this exercise, you will manually enter survey data to perform a mapcheck analysis.

This method of performing a mapcheck analysis is useful when you must check survey data that does not exist as labels in the drawing. For example, you can use this method to enter survey data from a paper drawing.



For more information, see the AutoCAD Civil 3D Help topic *Manually Entering Mapcheck Data*.

This exercise continues from [Exercise 2: Performing a Mapcheck Analysis with Parcel Labels](#) (page 173).

Set up the mapcheck analysis dialog box

NOTE This exercise uses *Survey-5B.dwg* with the modifications you made in the previous exercise.

The parcel segments on the right side of the site are not labeled. Because the data is not available in parcel labels, you must enter the mapcheck information manually.

- 1 Click Analyze tab ► Ground Data panel ► Survey drop-down ► Mapcheck .
- 2 If a message that states the command line mode cannot be used while a command is active is displayed, click OK.
- 3 In the Mapcheck Analysis dialog box, make sure that the  Use Command Line Interface option is toggled off.
- 4 Click  Input View.
The input view provides an interface in which you can add data to the mapcheck analysis.

Enter parcel data

- 1 Click  New Mapcheck.



- 2 In the Mapcheck Analysis dialog box, for the name of the mapcheck, enter Parcel Manual Input.
- 3 To specify the point of beginning, enter the following values:
 - Easting: 5576.199
 - Northing: 5291.0640





The  icon indicates the point of beginning.

- 4 Click  New Side.
- 5 Expand the Side 1 collection. Specify the following parameters:

NOTE Notice that the  icon is displayed next to the side collection, and also next to the top-level mapcheck collection. This indicates that the mapcheck is incomplete, because it requires more data about the side.

- Side Type: Line
 - Angle Type: Direction
 - Angle: N00 00 10E
 - Distance: 16.330
- 6 Click  New Side.
 - 7 Expand the Side 2 collection. Specify the following parameters:
 - Side Type: Curve
 - Curve Direction: Clockwise
 - Radius: 20.00
 - Arc Length: 21.550
 - 8 Click  New Side.
 - 9 Expand the Side 3 collection. Specify the following parameters:
 - Side Type: Curve
 - Curve Direction: Counter-clockwise

- Radius: 75.00
 - Arc Length: 80.800
- 10 Click  New Side.
- 11 Expand the Side 4 collection. Specify the following parameters:
- Side Type: Line
 - Angle: N90 00 00E
 - Distance: 99.990
- 12 Click  New Side.
- 13 Expand the Side 5 collection. Specify the following parameters:
- Side Type: Line
 - Angle: S0 00 00E
 - Distance: 100
- 14 Click  New Side.
- 15 Expand the Side 6 collection. Specify the following parameters:
- Side Type: Line
 - Angle: N89 59 54W
 - Distance: 149.990
- The direction arrow meets the point of beginning.

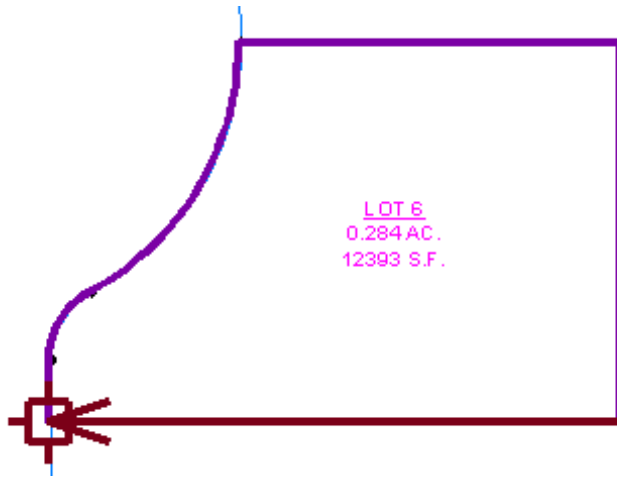

- 16 Click  Output View.

The Output View displays the results of the mapcheck analysis. You will learn how to work with the output data in [Exercise 4: Working with Mapcheck Data](#) (page 179).

To continue this tutorial, go to [Exercise 4: Working with Mapcheck Data](#) (page 179).

Exercise 4: Working with Mapcheck Data

In this exercise, you will learn about the tools that can leverage the data obtained from a mapcheck analysis.

For more information, see the AutoCAD Civil 3D Help topic *Mapcheck Analysis*.

This tutorial continues from [Exercise 3: Performing a Mapcheck Analysis by Manually Entering Data](#) (page 176).



Change the default appearance of the mapcheck objects

NOTE This exercise uses *Survey-5B.dwg* with the modifications you made in the previous exercise.

- 1 In Toolspace, on the Settings tab, expand the General ► Commands collection. Right-click MapCheck. Click Edit Command Settings.

- 2 On the Edit Command Settings dialog box, expand the Mapcheck collection. Examine the default settings that are available.
The colors in this collection specify the appearance of the mapcheck objects. Notice that Mapcheck Color currently is set to green.
- 3 Click in the Mapcheck Color Value cell. Click .
- 4 In the Select Color dialog box, in the Color field, enter 10. Click OK.
- 5 In the Edit Command Settings dialog box, click OK.
In the drawing window, notice that the mapcheck object around LOT 5 is red.

Move mapcheck data into the drawing

- 1 In the Mapcheck Analysis dialog box, click  Output View.
- 2 Select the Parcel Labels mapcheck.
- 3 Click  Insert Mtext.
- 4 Pan to a clear area of the drawing. Click to place the Mtext.

Save mapcheck data to a text file

- 1 Click  Copy To Clipboard.
- 2 On the command line, enter NOTEPAD. When you are prompted for a file to edit, press Enter.
- 3 In the Microsoft Notepad window, press Ctrl+V.
The mapcheck data is displayed in Microsoft Notepad. You can save this file for later analysis in another application.

Create a polyline from the mapcheck data

- 1 Select the Parcel Manual Input mapcheck.
- 2 Click  Create Polyline.
A polyline is created on the perimeter of LOT 5. You can perform any standard AutoCAD functions on the polyline.

To continue this tutorial, go to [Exercise 5: Creating Surface Breaklines from Figures](#) (page 181).

Exercise 5: Creating Surface Breaklines from Figures

In this exercise, you will use figures to add breaklines to a surface.

The breaklines will define the edge of pavement (EP) features, such as retaining walls, curbs, tops of ridges, and streams. Breaklines force surface triangulation along the breakline and prevent triangulation across the breakline.

For more information, see the AutoCAD Civil 3D Help topic *Creating Breaklines from Figures*.

This exercise continues from [Exercise 4: Working with Mapcheck Data](#) (page 179).

To create surface breaklines from figures

- 1 Open *Survey-5C.dwg*, which is located in the [tutorial drawings folder](#) (page 819).



This drawing contains the empty surface Figure Surface 1, to which you will add the figure data.

NOTE For more information about creating surfaces, see the [Creating and Adding Data to a Surface](#) (page 59) tutorial.

- 2 In Toolspace, on the Survey tab, open the survey database Survey 1 and click the Figures collection.
- 3 In the list view, click figure EP1.
- 4 Press the Shift key, click figure EP7.
- 5 Keeping the Shift key pressed, right-click figure EP7 and click Edit Figures. The Figures Editor is displayed with only the EP figures that you selected.
- 6 To change the Breakline property to Yes for all EP figures, right-click the column heading Breakline and click Edit.
- 7 Enter Y and press Enter.

The Breakline property for all figures is changed to Yes.

NOTE The figures are displayed with bold text indicating there are unsaved changes.

- 8 Click  to save the changes to the survey database.
- 9 Click  to close the Figures Editor vista.
- 10 In Toolspace, on the Survey tab, right-click the Figures collection and click Create Breaklines.
- 11 In the Create Breaklines dialog box, click the Select Surface drop-down list and click Figure Surface 1. All the figures are listed in the dialog box, and the EP figures are listed as breaklines.
- 12 Click OK.
- 13 In the Add Breaklines dialog box, enter the following:
 - Description: EP
 - Type: Standard
 - Mid-ordinate Distance: 0.1

NOTE For more information about breaklines, see [Exercise 3: Adding Breaklines to a Surface](#) (page 65)

- 14 Click OK.

The surface border and contours are displayed in the drawing.

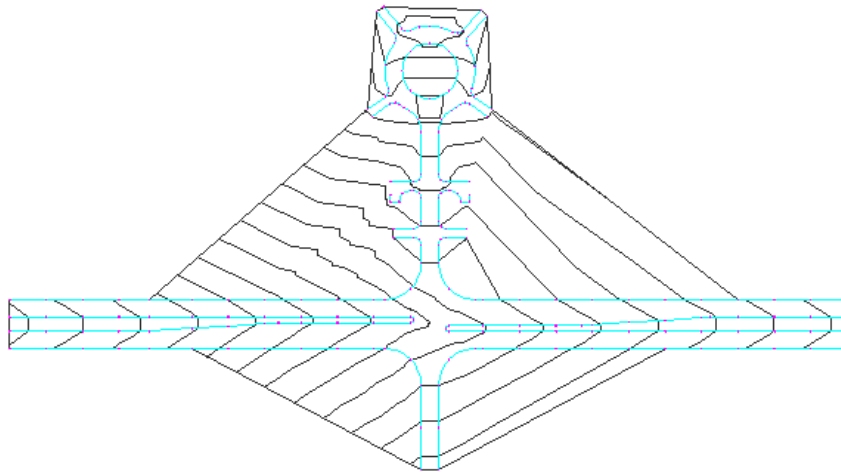

Project Management Tutorials

7

These tutorials will get you started working with the AutoCAD Civil 3D project management tools. You can use the project management functionality to provide shared access to engineering data while preserving data integrity.

Two methods of project management are explained in these tutorials: data shortcuts and Vault.

NOTE All drawings used in these tutorials are available in the [tutorial drawings folder](#) (page 819). If you want to save your work from these tutorials, save the drawings to the [My Civil Tutorial Data folder](#) (page 819) so that you do not overwrite the original drawings.

For more information, see the AutoCAD Civil 3D Help topic *Understanding Project Management*.

Tutorial: Using Data Shortcuts

This tutorial demonstrates how to create a data shortcuts project, create data shortcuts from objects in one drawing, and then import the data shortcuts into another drawing.

A data shortcut provides a complete reference copy of an object that you can import from one drawing into one or more other drawings. Data shortcuts provide a flexible, object-level project management tool without the administrative overhead that is associated with Autodesk Vault. Data shortcuts are managed in Toolspace on the Prospector tab, in a structure that is similar to Autodesk Vault. However, data shortcuts do not provide the editing controls, protection, and data security that Autodesk Vault does.

In order for multiple users to use a data shortcut, it must be stored in a network location that is accessible to all users. You can use data shortcuts to reference surface, alignment, profile, pipe network, and view frame group objects. If a

referenced object is changed in the source drawing, changes are updated in any drawings that reference the object.

For more information, see the AutoCAD Civil 3D Help topic *Using Data Shortcuts*.

Exercise 1: Setting Up a Data Shortcut Folder

In this exercise, you will set up a folder in which to store objects that are referenced through data shortcuts.

The data shortcut folder contains all the source drawings and data shortcut objects in a project.

For more information, see the AutoCAD Civil 3D Help topic *Using Data Shortcuts*.

Access the project management tools in Prospector

- 1 Open drawing *Project Management-1.dwg*, which is available in the [tutorial drawings folder](#) (page 819).

This drawing contains an existing ground surface, alignments that represent intersecting road centerlines, and parcel objects that represent property boundaries. In the following exercises, you will create data shortcuts to the surface and alignments in this drawing, and then reference them in a new drawing.

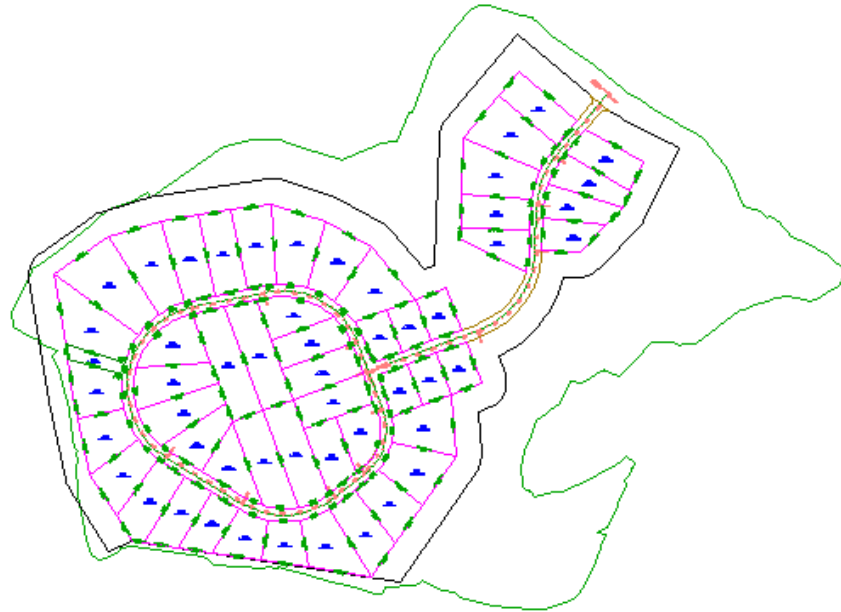

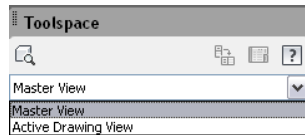

- 2 In Toolspace, on the Prospector tab, select the Master View.



Set the working folder

- 1 Right-click the  Data Shortcuts collection. Click Set Working Folder. The working folder is the parent folder where you save project folders. For this exercise, you will specify a folder on your hard drive as your working folder.
- 2 In the Browse For Folder dialog box, navigate to the [Civil 3D Projects folder](#) (page 819). Click OK.

Create a data shortcuts project

- 1 Right-click the  Data Shortcuts collection. Click New Data Shortcuts Project Folder.
- 2 In the New Data Shortcut Folder dialog box, select the Use Project Template check box.
- 3 Under Project Templates Folder, click .
- 4 In the Browse For Folder dialog box, navigate to the [Civil 3D Projects folder](#) (page 819).
- 5 In the Browse For Folder dialog box, select the [Civil 3D Project Templates folder](#) (page 819). Click OK.
- 6 In the New Data Shortcuts Folder dialog box, specify the following parameters:
 - Name: Tutorial Data Shortcuts Project
 - Use Project Template: Selected
 - Project Template: select _Sample Project

Notice that the folder you specified in Step 5 is displayed in the Working Folder field.

- 7 Click OK.
- 8 Using Windows Explorer, navigate to the [Civil 3D Projects folder](#) (page 819). Examine the folder structure in the Tutorial Data Shortcuts Project folder.

The folder structure provides separate locations for data shortcuts, source drawings, and other data. You will save project objects in these folders in the next exercise.

This is a typical structure for an AutoCAD Civil 3D project. Folders are provided for many of the document types that are typical of a civil engineering project.

To continue this tutorial, go to [Exercise 2: Creating Data Shortcuts](#) (page 186).

Exercise 2: Creating Data Shortcuts

In this exercise, you will create data shortcuts from the objects in a drawing. The data shortcuts will be available to reference into other drawings.

For more information, see the AutoCAD Civil 3D Help topic *Creating Data Shortcuts*.

This exercise continues from [Exercise 1: Setting Up a Data Shortcut Folder](#) (page 184).

Save the source drawing with the project

NOTE This exercise uses *Project Management-1.dwg* with the modifications you made in the previous exercise.



- 1 Click  ► Save As.
- 2 In the Save Drawing As dialog box, navigate to the [Civil 3D Projects folder](#) (page 819) \Tutorial Data Shortcuts Project\Source Drawings folder. Click Save.

Source drawings that contain objects that are referenced in other drawings should be saved with the data shortcuts project.

Create data shortcuts

- 1 Click Manage tab ► Data Shortcuts panel ► Create Data Shortcuts .



NOTE As a best practice, each object should reside in a separate drawing. To save time in this exercise, all the reference objects are in the current drawing.

- 2 In the Create Data Shortcuts dialog box, select the following check boxes:
 - Surfaces
 - Alignments

This action selects the EG surface and both alignments in the drawing.

- 3 Click OK.
Now that the data shortcuts have been created, the current drawing is associated with the data shortcuts project. Notice that, in the AutoCAD Civil 3D title bar, [Tutorial Data Shortcuts Project] is displayed after the drawing name.

Examine the data shortcuts in the project

- 1 In Toolspace, on the Prospector tab, expand the  Data Shortcuts collection. Expand the  Surfaces and  Alignments collections. Notice that data shortcuts have been created for the objects you selected in Step 4. In the next exercise, you will reference these objects in another drawing.
- 2 Using Windows Explorer, navigate to the [Civil 3D Projects folder](#) (page 819)**Tutorial Data Shortcuts Project**. Examine the contents of the subfolders:
 - *_Shortcuts\Alignments*: This folder contains an XML file for each alignment in the source drawing. The XML files identify the path to the drawing that contains the alignment, the name of the source drawing, and the name of the alignment.
 - *_Shortcuts\Profiles*: This folder contains an XML file for each profile in the source drawing. The XML files identify the path to the drawing that contains the profile, the name of the source drawing, and the name of the profile.
 - *_Shortcuts\Surfaces*: This folder contains an XML file for the EG surface.
 - *Source Drawings*: This folder contains the source drawing, which you saved in Step 6. The source drawings should always be saved with the data shortcut project. In a real project, you would save the drawings that contain each object in the subfolders.

While it is useful to know that the data shortcut XML files exist, you do not work directly with them in normal data referencing operations. Management of data references is done in Toolspace on the Prospector tab.

NOTE Leave *Project Management-1.dwg* open for the next exercise.

To continue this tutorial, go to [Exercise 3: Referencing Data Shortcuts](#) (page 188).

Exercise 3: Referencing Data Shortcuts

In this exercise, you will reference several shortcuts in a new drawing.

For more information, see the AutoCAD Civil 3D Help topic *Referencing a Project Object*.





This exercise continues from [Exercise 2: Creating Data Shortcuts](#) (page 186).

Reference data shortcuts in a new drawing

NOTE Before you perform this exercise, you must have created data shortcuts as described in the previous exercise.

- 1 Open drawing *Project Management-2.dwg*, which is available in the [tutorial drawings folder](#) (page 819).

This drawing is empty. In the following steps, you will reference the objects for which you created data shortcuts in the previous exercise.

- 2 In Toolspace, on the Prospector tab, in the  Data Shortcuts   Surfaces collection, right-click EG. Click Create Reference.
In the Create Surface Reference dialog box, notice that you can specify a Name, Description, Style, and Render Material for the surface. The parameters that define the object cannot be modified in the current drawing, but you can adjust the object properties. For this exercise, you will accept the existing property settings, except for the surface style.
- 3 In the Create Surface Reference dialog box, in the Style row, click the Value column. Click .
- 4 In the Select Surface Style dialog box, select Contours 5m and 25m (Background). Click OK.
- 5 In the Create Surface Reference dialog box, click OK.
The EG surface is displayed in the drawing using the style that you specified.

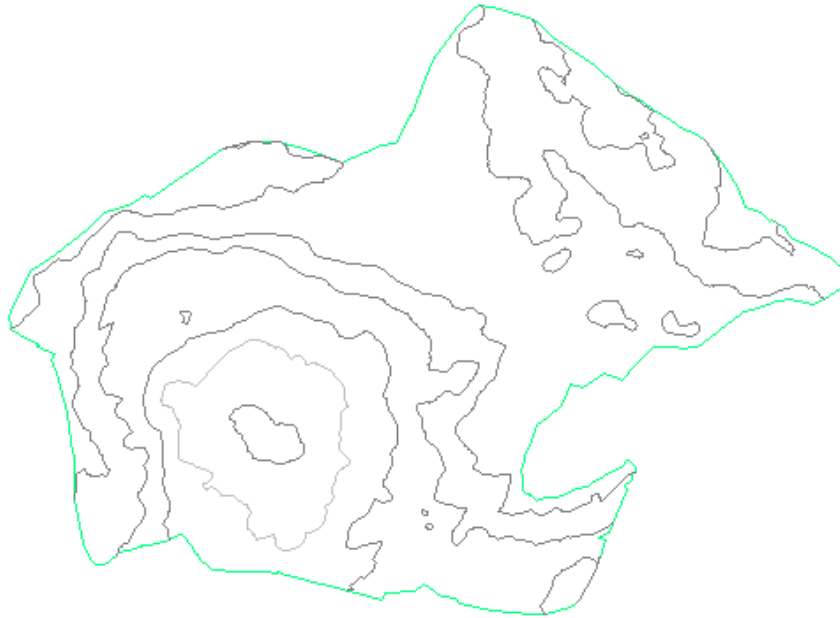

NOTE If you cannot see the surface, enter ZE on the command line.



Now that the data shortcuts have been referenced, the current drawing is associated with the data shortcuts project. Notice that, in the AutoCAD Civil 3D title bar, [Tutorial Data Shortcuts Project] is displayed after the drawing name.

- 6 In Toolspace, on the Prospector tab, expand the Project Management-2 ►  Surfaces collection.

Notice that the EG surface is displayed in the Surfaces collection. The  icon indicates that the surface was created from a data shortcut.

- 7 In the  Data Shortcuts ►  Alignments collection, right-click First Street. Click Create Reference.
- 8 In the Create Alignment Reference dialog box, click OK.
The alignment is displayed in the drawing.

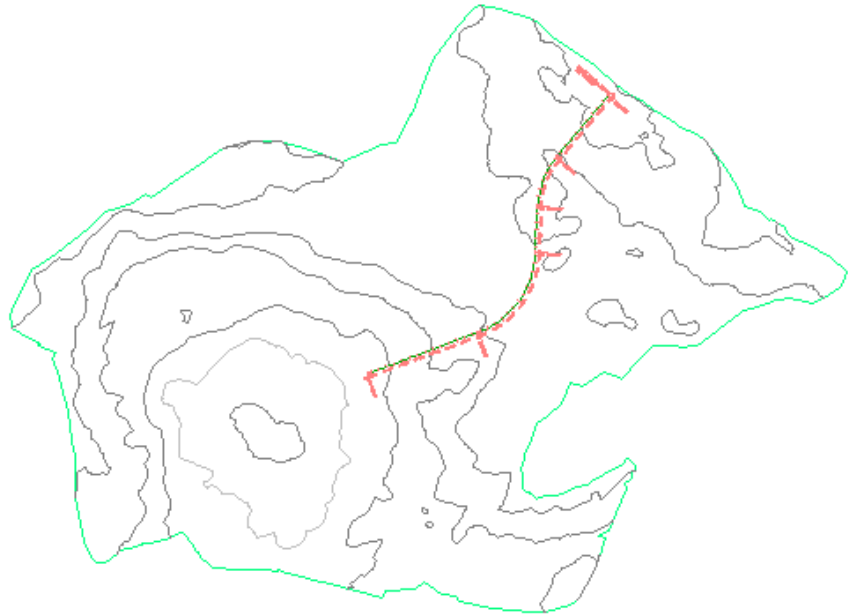

Create an object from the referenced objects

- 1 Click Home tab ► Create Design panel ► Profile drop-down ► Create Surface Profile  .
- 2 In the Create Profile From Surface dialog box, specify the following parameters:
 - Alignment: First Street
 - Select Surfaces: EG
- 3 Click Add.
- 4 Click Draw In Profile View.
- 5 In the Create Profile View wizard, on the General page, for Profile View Style, select Major Grids.
- 6 Click Create Profile View.
- 7 In the drawing, click to place the profile view grid.

The referenced surface and alignment are read-only objects in the drawing and require little storage space. You can use the referenced object data

to create other objects in the current drawing, but you cannot change the source objects.

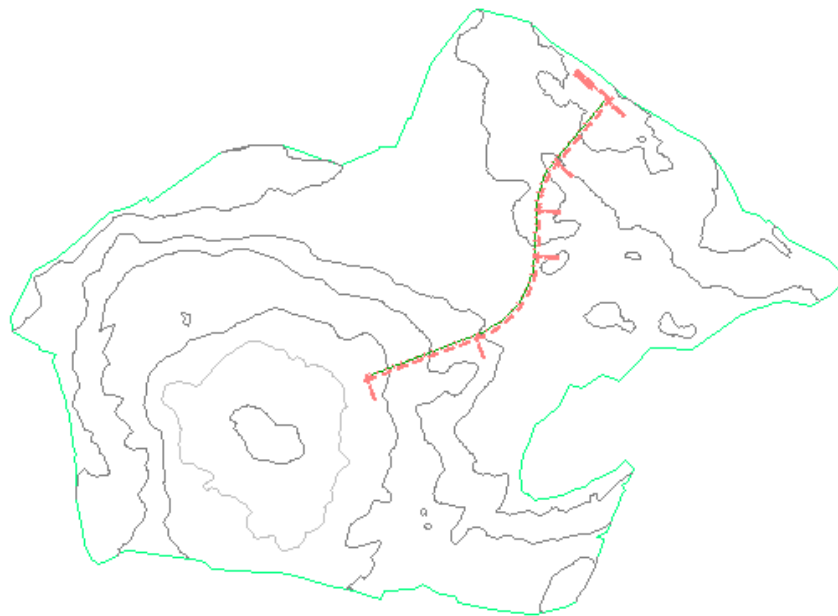
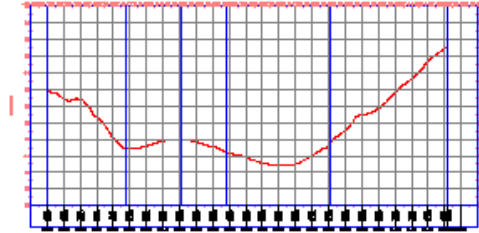

Save the current drawing



- 1 Click  Save As.
- 2 In the Save Drawing As dialog box, navigate to the [Civil 3D Projects folder](#) (page 819)**Tutorial Data Shortcuts Project\Production Drawings**. Click Save.

Like source drawings, the final production drawings that contain references to other objects should be saved with the data shortcuts project.

Next, you will modify the alignment in the source drawing, and then update the current drawing to reflect the changes.

Change a referenced object in the source drawing

- 1 In Toolspace, on the Prospector tab, click *Project Management-1.dwg*. Right-click. Click Switch To.
- 2 Select the alignment.
- 3 Move the grips to change the alignment layout.

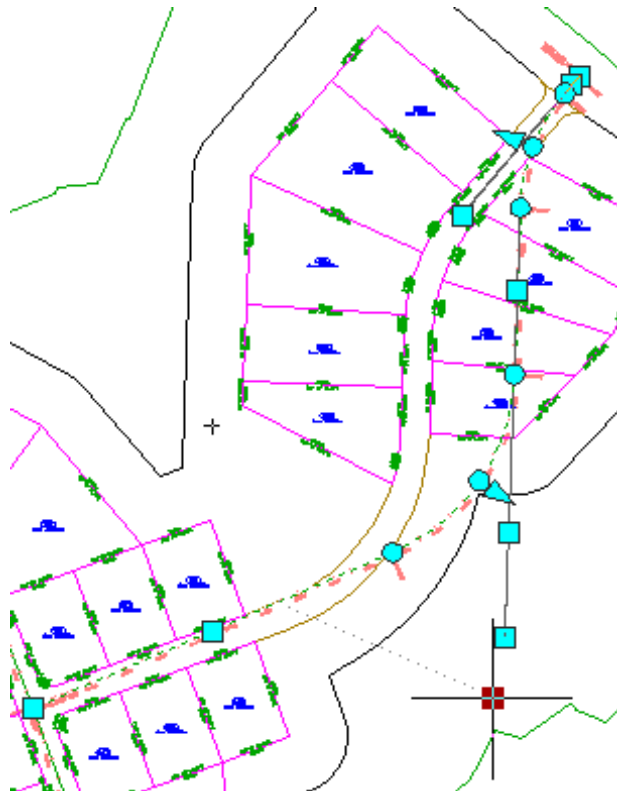

- 4 Click  Save.

Synchronize the current drawing to the source drawing

- 1 In Toolspace, on the Prospector tab, click *Project Management-2.dwg*. Right-click. Click Switch To.
- 2 Expand the *Project Management-2* ► Alignments ► Centerline Alignments collection.

The  icon indicates that the reference to the source drawing is out of date.

- 3 Right-click the First Street alignment. Click Synchronize.

Notice that the alignment is updated to reflect the changes you made in the source drawing. Also notice that the surface profile that you created from the alignment has been updated.

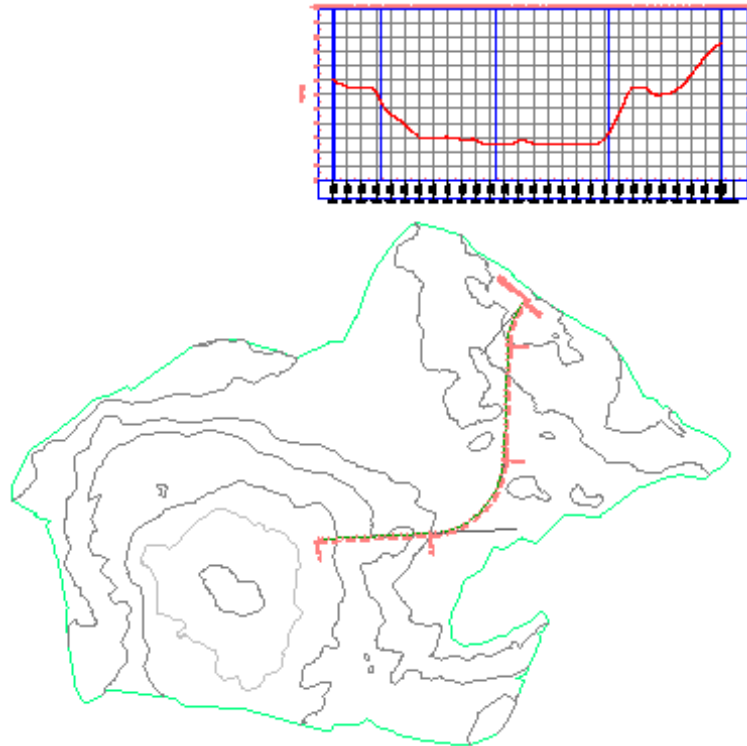

NOTE This is the end of the data shortcuts tutorial. The next tutorials in this section demonstrate how to structure a project using Autodesk Vault.

To continue to the next tutorial, go to [Database Setup](#) (page 195).

Tutorial: Vault Setup

In this tutorial, you will act as a project administrator, creating a project in Autodesk Vault and some sample users.

You will log in as various users to see how the work of one user affects the work of another user. You will add files to the project, practice checking files in and out, and create object references.

The design of this tutorial assumes that you have installed the stand-alone version of Autodesk Data Management Server on your computer. This enables you to log in to the Vault database as the Administrator and create some sample users. However, if you are working with an Autodesk Vault database that is shared on a network and you are not permitted to log in as the Administrator, skip [Exercise 2: Creating User Accounts and Groups](#) (page 197) and do the remaining exercises in this tutorial. You may need to modify some steps to suit your database setup.

If you are the Administrator of a shared database, you can use this tutorial as a basis for training users on correct procedures. To protect your existing data, and prepare a safe learning environment, the following steps are recommended:

- 1 Create a separate Vault project.
- 2 Create a few user accounts and groups that can access only the Tutorial database. The steps in [Exercise 2: Creating User Accounts and Groups](#) (page 197) provide some useful guidelines.
- 3 Review the tasks in this tutorial to verify that users can do all the steps as written. If necessary, prepare additional instructions for your users, or prepare a revised version of the tutorial.

For best results, do the exercises in this tutorial in the order they are presented. Many of the exercises depend on having the database in a particular state created by completing the preceding exercise.

For more information, see the AutoCAD Civil 3D Help topic *Using Vault*.

Exercise 1: Logging In to Autodesk Vault

In this exercise, you will log in to Autodesk Vault to prepare for other project tasks.

For more information, see the AutoCAD Civil 3D Help topic *Logging In to a Vault Server*.

NOTE If projects are not displayed in the Master View of the Prospector tab, as indicated in step 1 below, you may need to do the following: If you are running Windows 2000, ensure that you have installed the Microsoft Windows 2000 Updates (including MDAC 2.7 SP1) as well as Service Pack 4. If you are running Windows XP, ensure that you have installed Service Pack 2.

Log in to the database

- 1 In Toolspace, click the Prospector tab.

NOTE Ensure that you have a drawing open and that you select the Master View from the list at the top of the Prospector tab.

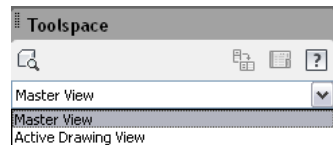

In the Prospector tree, you should see the  Projects collection.

- 2 Right-click the Projects collection and click Log In To Vault.
- 3 If the Welcome dialog box appears, click Log In.
- 4 In the Log In dialog box, review the four data fields:
 - User Name: Administrator. Leave this entry as is.
 - Password: blank. Leave this field blank for this exercise.
 - Server: localhost (for stand-alone local database), or if you have a central Data Management Server on your network, use its name.
 - Database: Vault. Leave this entry as is, unless your system administrator advises you to use a different database.
- 5 Click OK.

The system logs you in to Autodesk Vault.
- 6 Right-click the Projects collection and click Properties.
- 7 In the Properties – Civil 3D Projects dialog box, note that the default location for the Working Folder.

- 8 Click OK.

To continue this tutorial, go to [Exercise 2: Creating User Accounts and Groups](#) (page 197).

Exercise 2: Creating User Accounts and Groups

In this exercise, you will create two user accounts and two user groups that can access files in the database.

For more information, see the AutoCAD Civil 3D Help topics *Creating Vault User Accounts* and *Creating Vault Groups*.

This procedure assumes that you are already logged in to the database as described in [Exercise 1: Logging In to Autodesk Vault](#) (page 195).

NOTE You cannot create a user group without assigning at least one user to the group. Therefore, you should create some user accounts before creating groups.

Create user accounts

- 1 To open Autodesk Vault Explorer, in Toolspace, on the Prospector tab, right-click the Projects collection, and click Autodesk Vault.

NOTE You can also open Autodesk Vault Explorer from the Start menu ► Programs ► Autodesk ► Autodesk Data Management ► Autodesk Vault 2011.

- 2 In the Welcome dialog box, click Log In.
- 3 In the Log In dialog box, verify the Administrator's login data, then click OK.
- 4 In Autodesk Vault, ensure that the correct database (vault) is selected.
If you are using the default stand-alone server, there is only one database, and it is Vault. The current server, database (Vault), and user are displayed in the lower right corner of Autodesk Vault
- 5 In Autodesk Vault, click Tools menu ► Administration ► Global Settings.
- 6 In the Global Settings dialog box, on the Security tab, click Users.
- 7 In the User Management dialog box, click New User.

- 8 In the New User dialog box, enter the following information:
 - First Name: Pat
 - Last Name: Red
 - User Name: pred
 - Password: red123
 - Confirm Password: red123
- 9 Select Enable User. Click OK.
- 10 Repeat steps 7 through 9 to create another user profile as follows:
 - First Name: Kim
 - Last Name: Green
 - User Name: kgreen
 - Password: green123
 - Confirm Password: green123
- 11 Close the User Management dialog box.

Create user groups

- 1 In the Global Settings dialog box, on the Security tab, click Groups.
- 2 In the Groups dialog box, click New Group.
- 3 In the Group dialog box, in the Group Name field, enter Engineers.
- 4 Click the Roles button, then select Administrator. Click OK.
- 5 Click the Vaults button, then select the database that your test users will work in. Select the default value, which is Vault. Click OK.
- 6 Select Enable Group.
- 7 Click the Add button.
- 8 To add the member pred to the group, in the Add Members dialog box, in the Available Members table, click the row for pred. Click Add.
- 9 Click OK to close the Add Members dialog box.
- 10 Click OK to close the Group dialog box.

- 11 In the Group Management dialog box, click New Group again, and repeat Steps 3 through 10 to create a group named Technicians. This group has the role of Vault Consumer and access to the same Vault database. Add user kgreen to the Technicians group.

You will not see the advantages of creating user groups in this tutorial, but the structure you have just created is recommended for project teams. Groups can have different roles in relation to a particular database, and you can change the roles of users by moving them into the appropriate group.

- 12 Click Close to close the Global Settings dialog box and then close Autodesk Vault.

To continue this tutorial, go to [Exercise 3: Creating a Project](#) (page 199).

Exercise 3: Creating a Project

This exercise demonstrates how to log in to the project management system and create a project.

A project is a collection in the Prospector tree that represents objects in a database (vault). Each project is essentially a folder that contains drawings, databases of points, and reference objects, such as surfaces, alignments, and pipe networks. A project folder can also contain other documents relevant to an engineering project.

A database user with the Vault Editor role can create projects.

For more information, see the AutoCAD Civil 3D Help topic *Working with Vault Projects*.

The following procedure assumes that you are already logged in to the database as described in [Exercise 1: Logging In to Autodesk Vault](#) (page 195).

Create a project

- 1 In Toolspace, on the Prospector tab, right-click the Projects collection, then click New.
- 2 In the New Project dialog box, for Name, enter Tutorial Vault Project. Optionally, add a short Description.
- 3 Select the Use Project Template check box.

When you select this option, you can specify a template to use in structuring your project. This option enables you to structure similar projects in the same way.

- 4 In the Project Templates Folder area, click .
- 5 In the Browse For Folder dialog box, navigate to the [Civil 3D Project Templates folder](#) (page 819)_Sample Project folder.
This is a typical structure for an AutoCAD Civil 3D project. Folders are provided for many of the document types that are typical of a civil engineering project.
- 6 In the Browse For Folder dialog box, select the [Civil 3D Project Templates folder](#) (page 819). Click OK.
- 7 In the New Project dialog box, in the Project Template field, select _Sample Project.
- 8 Click OK.
- 9 Under the Projects collection, expand the Tutorial Vault Project collection.
Examine the folders and nodes that were created from the template you specified in Step 7. For example, the Drawings collection contains folders in which you can save different types of project drawings. The object collections will contain data references to AutoCAD Civil 3D objects that reside in the project drawings.

To continue to the next tutorial, go to [Creating, Referencing, and Modifying Project Object Data](#) (page 200).

Tutorial: Creating, Referencing, and Modifying Project Object Data

In this tutorial, you will add a drawing to the project, create a project surface and then access the surface from another drawing. You will use the *Surface-3.dwg* tutorial drawing as the starting point.

This tutorial continues from the [Database Setup](#) (page 195) tutorial.

If you are logged in as Administrator, log out and log in as the first test user, pred (password: red123). To log out, right-click the Projects collection in Prospector, Master View, and click Log Out. Then right-click Projects and click Log In To Vault.

Each project object begins as an object within a drawing. When you add the drawing to the project, you specify which objects in the drawing you want to share with other members of the project team.

For more information, see the AutoCAD Civil 3D Help topic *Working with Vault Project Objects*.

Exercise 1: Adding a Drawing to the Project

In this exercise, you will add a drawing to a project. In the process, you will create a shared project surface.

You will create a drawing named *Project-XGND.dwg* that contains the surface to be shared.

For more information, see the AutoCAD Civil 3D Help topic *Adding a Drawing to a Project*.

Save the drawing with the project

- 1 Open drawing *Surface-3.dwg*, which is available in the [tutorial drawings folder](#) (page 819).

This drawing contains COGO points and an existing ground surface. Because you will share this data with other users, you must save the drawing with the project.



- 2 Click  Save As.
- 3 In the Save Drawing As dialog box, browse to the following location:
[Civil 3D Projects folder](#) (page 819)**Tutorial Vault Project\Source Drawings\Surfaces**
- 4 For File Name, enter Project-XGND.dwg.
- 5 Click Save.

NOTE You must be logged in to Autodesk Vault to perform the following steps. see [Exercise 1: Logging In to Autodesk Vault](#) (page 195) for instructions.

Create a reference object

- 1 On the Prospector tab, ensure that Master View is selected, and expand the Open Drawings collection. Right-click *Project-XGND.dwg* and click Check In.
- 2 In the first Add To Project dialog box, select Tutorial Vault Project.
- 3 Click Next.
- 4 On the Select A Drawing Location page, select the Source Drawings ► Surfaces folder.
- 5 Click Next.
- 6 On the Drawing File Dependencies page, select *Project-XGND.dwg*.
- 7 Click Next.
- 8 On the Share Data page, select XGND.
- 9 Click Finish.
- 10 On the Prospector tab, under the Projects collection, expand the Tutorial Vault Project collection. Expand the Drawings collection, and the Source Drawings ► Surfaces folder.

The  icon displayed next to *Project-XGND.dwg* indicates that the drawing is available to be checked out.

- 11 Under the Tutorial Vault Project collection, expand the Surfaces object collection.

The  icon next to XGND indicates that the project drawing that contains the surface is available to be checked out.

To continue this tutorial, go to [Exercise 2: Creating a Reference to a Project Object](#) (page 202).

Exercise 2: Creating a Reference to a Project Object

In this exercise, you will create a drawing and create a read-only copy of a project surface in the drawing.

For more information, see the AutoCAD Civil 3D Help topic *Creating References to Project Objects*.

This exercise continues from [Exercise 1: Adding a Drawing to the Project](#) (page 201).

Create a reference to a project object



1 Click  ► New.

2 In the Select Template dialog box, click *_AutoCAD Civil 3D (Imperial) NCS.dwt*. Click Open.



3 Click  ► Save As.

4 In the Save Drawing As dialog box, browse to the following location:
[Civil 3D Projects folder](#) (page 819)**Tutorial Vault Project\Production Drawings**

5 Save the file as *Project-1.dwg*.

6 On the Prospector tab, expand the Projects collection ► Tutorial Vault Project ► Surfaces. Right-click XGND. Click Create Reference.

7 In the Create Surface Reference dialog box, change the surface style from Contours 2' And 10' (Background) to Contours And Triangles.

This style specifies how the surface XGND will be displayed in the drawing Project-1. This style setting is independent of the surface style used for the master copy of the surface in *Project-XGND.dwg*.

8 Click OK.

NOTE If the Event Viewer is displayed, indicating that the surface is created, close it.

The drawing Project-1 now contains a read-only copy of the project surface XGND. The master copy of the object remains untouched in the project database. The drawing Project-1 is not in the project database, but it is considered to be attached to the Tutorial Vault Project because it contains a reference to an object in that project. While this link remains, the drawing Project-1 can include references to other objects in the Tutorial project, but cannot contain references to objects in other projects.

9 Save and close the drawing.

To continue this tutorial, go to [Exercise 3: Checking Out and Modifying a Project Object](#) (page 204).

Exercise 3: Checking Out and Modifying a Project Object

You check out a project object by checking out the drawing that contains the object.

In this exercise, you will check out and modify the drawing that contains the surface object XGND.

For more information, see the AutoCAD Civil 3D Help topic *Checking Out Project Object Source Drawings*.

This exercise continues from [Exercise 2: Creating a Reference to a Project Object](#) (page 202).

Check out a reference object

- 1 On the Prospector tab, expand the Projects ► Tutorial Vault Project ► Drawings collection.
- 2 Select the Source Drawings ► Surfaces folder to display the list view for the collection.

In the list view, note that the Version for *Project-XGND.dwg* is 1.

The  icon next to *Project-XGND.dwg* indicates that the drawing is checked in.

- 3 Right-click *Project-XGND.dwg* and click Check Out.
- 4 In the Check Out Drawing dialog box, verify that *Project-XGND.dwg* is selected.
- 5 Click OK.

The drawing is checked out and opened. The  icon next to *Project-XGND.dwg* in the Open Drawings collection indicates that the drawing is checked out to you. In the next few steps, you will modify the surface by adding a breakline.

Modify the source object

- 1 With the surface clearly visible, click  (the Polyline tool) and draw a polyline anywhere on the surface.

- 2 Expand Open Drawings ► Project-XGND ► Surfaces ► XGND ► Definition.
- 3 In the surface Definition, right-click the Breaklines collection. Click Add.
- 4 In the Add Breaklines dialog box, optionally give the breakline a name. Click OK. In the drawing window, click the polyline to convert it to a breakline.



- 5 Click  ► Save to save the changes to the surface.

Further exploration: If you want to see how the drawing icon appears to another database user, complete the following steps:

- On the Prospector tab, Master View, right-click the Projects collection and click Log Out.
- Right-click the Projects collection, click Log In, then log in as user kgreen.
- In the Tutorial Vault Project, note the 'checked out' icon next to *Project-XGND.dwg*.
- Hover the cursor over the 'checked out' icon to see a tooltip that indicates which user has checked out the drawing.
- Log out as kgreen, then log in as pred.

To continue this tutorial, go to [Exercise 4: Checking In a Project Object](#) (page 205).

Exercise 4: Checking In a Project Object

You check in a project object by checking in the checked-out drawing that contains it.

For more information, see the AutoCAD Civil 3D Help topic *Checking a Drawing In to a Project*.

In this exercise, you will check in the source drawing that contains the surface XGND, which you modified in the previous exercise.

This exercise continues from [Exercise 3: Checking Out and Modifying a Project Object](#) (page 204).

Before starting this exercise, ensure that you are logged in to the database as pred, or the same user who checked out the drawing *Project-XGND.dwg*.

Check in a project object

- 1 On the Prospector tab, expand the Open Drawings collection.
- 2 Right-click Project-XGND, and click Check In.
- 3 In the first Check In Drawing dialog box, verify that *Project-XGND.dwg* is selected.
- 4 Click Finish.
The drawing is checked in and closed.
- 5 Expand the Projects ► Tutorial Vault Project ► Drawings ► Source Drawings collection. Select the Surfaces folder to display the list view.
In the list view, note that the Version for file *Project-XGND.dwg* has changed from 1 to 2. Version 2 is the drawing containing the project surface with the most recent modifications.

To continue this tutorial, go to [Exercise 5: Updating a Project Object](#) (page 206).

Exercise 5: Updating a Project Object

When the drawing that contains a project object is checked in to the database, the changes are immediately available to other drawings that reference the object.

In this exercise you will open the drawing *Project-1.dwg* that references the surface XGND, which was modified in the previous exercise.

For more information, see the AutoCAD Civil 3D Help topic *Getting the Latest Version of Project Objects*.

This exercise continues from [Exercise 4: Checking In a Project Object](#) (page 205).

To update a project object



- 1 Click  Open. Navigate to [Civil 3D Projects folder](#) (page 819)**Tutorial Vault Project\Production Drawings**, and click the drawing *Project-1.dwg*.
- 2 In Toolspace, on the Prospector tab, expand the Surfaces collection. Right-click the surface XGND, and click Surface Properties.
- 3 In the Surface Properties dialog box, change the Surface Style to one that will make the breaklines visible, such as any of the Contours styles.

Notice that the breaklines are displayed on the surface, but you cannot move them. Also, because this surface is a reference object, the surface collection in Prospector does not show the breaklines or other elements of the surface definition that you cannot modify.

Further exploration: Keep the drawing *Project-1.dwg* open and check out *Project-XGND.dwg*. Add another breakline to the master copy of the surface, then right-click Project-1 and click Switch To to make this drawing active. See how the change to the surface is reflected in a reference object within a drawing that is already open.

To continue to the next tutorial, go to [Creating and Modifying Project Point Data](#) (page 207).

Tutorial: Creating and Modifying Project Point Data

This tutorial demonstrates how to create, access, and modify project point data.

You will add points to a project database, check out and modify a project point, and check the point back in.

For more information, see the AutoCAD Civil 3D Help topic *Working with Project Points*.

Exercise 1: Adding Points to a Project

In this exercise, you will add point data to the project.

To create project points, you first create a drawing that contains the points. When you are ready to share the points with others, you use the Add To Project command to add the points to the project point database. The project points can then be accessed by others.

After you create project points with the Add To Project command, a local copy of the points remains in the drawing. The icons displayed in the points list view indicate the state of a point with respect to the project.

For more information, see the AutoCAD Civil 3D Help topic *Adding Points to a Project*.

In this exercise, you will add points to the project from the drawing *Project-XGND.dwg*, which has already been added to the project.

This exercise continues from the [Creating, Referencing, and Modifying Project Object Data](#) (page 200) tutorial.

Add points to the project

- 1 In Toolspace, on the Prospector tab, expand Projects collection ► Tutorial Vault Project ► Drawings ► Source Drawings ► Surfaces folder. Right-click drawing *Project-XGND.dwg*, and click Open (Read-Only).
- 2 On the Prospector tab, in the Open Drawings collection, under Project-XGND, click Points to display the points list view.
- 3 In the points list view, select all the points by clicking the first row and then pressing Ctrl+A.
- 4 Right-click, and then click Add to Project.
This operation may take a few moments.

NOTE You can also add all points in a drawing to a project by expanding the Point Groups collections, right-clicking the *_All Points* point group, and clicking Add Points To Project.

- 5 In the Add To Project dialog box, click OK.

NOTE If you are prompted to check out the drawing, click No.

- 6 In the points lists view, the open lock  icon is now displayed next to each point. The icon indicates that it is a project point that is available to be checked out.

To continue this tutorial, go to [Exercise 2: Checking Out and Modifying Project Points](#) (page 209).

Exercise 2: Checking Out and Modifying Project Points

In this exercise, you will check out one project point and correct its elevation.

For more information, see the AutoCAD Civil 3D Help topic *Checking Out Points*.

This exercise continues from [Exercise 1: Adding Points to a Project](#) (page 207).

To check points out



1 Click  ► New.

2 In the Select Template dialog box, click *_AutoCAD Civil 3D (Imperial) NCS.dwt*. Click Open.



3 Click  ► Save As.

4 In the Save Drawing As dialog box, browse to the following location:
[Civil 3D Projects folder](#) (page 819)**Tutorial Vault Project\Production Drawings**

5 Save the file as *Project-Point.dwg*.

6 On the Prospector tab, expand the Projects ► Tutorial Vault Project collection.

7 Click the Points collection to display the points list view.

8 Select point number 3.

9 Right-click and click Check Out.

10 In the Check Out dialog box, click OK.

The point is checked out to the active drawing, *Project-Point.dwg*.

11 In the Open Drawings collection, expand the Project-Point drawing and click Points to display the list view.

The  icon in the drawing list views indicates that the point is a checked-out project point.

- 12 To modify point 3 by adjusting its elevation, click in the list view under Point Elevation and enter 96.434.
- 13 Save the drawing.

To continue this tutorial, go to [Exercise 3: Checking In Project Points](#) (page 210).

Exercise 3: Checking In Project Points

In this exercise, you will check in a modified project point to update the master version of the point in the project point database.

Checking in the updated point creates a version and makes your changes available to others.

For more information, see the AutoCAD Civil 3D Help topic *Checking In Points*.

This exercise continues from [Exercise 2: Checking Out and Modifying Project Points](#) (page 209).

Check points in

- 1 In the Open Drawings collection, expand the Project-Point drawing and click the Points collection to display the points list view.

The  icon displayed next to the modified point indicates that it is checked out to you.

- 2 In the list view, select point number 3.
- 3 Right-click and click Check In.
- 4 In the Check In dialog box, click OK.

The  icon displayed next to the point in the list view shows you that the point has been checked in with your changes. If you expand the Projects ► Tutorial Vault Project collection and click Points, you can see in the list view that Point 3 is set to Version 2.

To continue to the next tutorial, go to [Exporting and Importing Vault Projects](#) (page 211).

Tutorial: Exporting and Importing Vault Projects

This tutorial demonstrates how to export a Vault project, and how to import a data shortcuts project into Vault.

You will export the Vault project that you created in the [Vault Setup](#) (page 199) tutorial. Then, you will import into Vault the data shortcut project that you created in the [Using Data Shortcuts](#) (page 183) tutorial.

For more information, see the AutoCAD Civil 3D Help topic *Working with Vault Projects*.

Exercise 1: Exporting a Vault Project

In this exercise, you will export a Vault project into a portable ZIP file.

Project export is useful for archiving a project, or packaging it for transmission to another vault.

For more information, see the AutoCAD Civil 3D Help topic *Exporting a Project*.

Export a project

- 1 In Toolspace, on the Prospector tab, Projects collection, right-click Tutorial Vault Project ► Export To ZIP file.

NOTE The Event Viewer might indicate that project drawings must be closed before the project can be exported. Make sure that all project drawings are closed, and then repeat Step 1.

- 2 In the Browse For Folder dialog box, navigate to the [My Civil Tutorial Data folder](#) (page 819). Click OK.
While the operation continues, you see a progress bar, then a message about successful export with the complete path to the ZIP file.
- 3 In the message dialog that reports the successful export, note the complete path to the ZIP file, then click OK.
- 4 In Windows Explorer, navigate to the [My Civil Tutorial Data folder](#) (page 819).
- 5 Extract the ZIP file with WinZip or another file compression utility.

To continue this tutorial, go to [Exercise 2: Importing a Data Shortcut Project into Vault](#) (page 212).

Exercise 2: Importing a Data Shortcut Project into Vault

In this exercise, you will import a data shortcut project into Vault, creating a new Vault project in the process.

Project import is more than just the reverse of export. You can use this operation to import a data shortcut project into Vault, or to import several drawings that are not part of a formal project. In the import process, any data shortcut references are converted into Vault references.

NOTE Before you start this exercise, you must have created the data shortcuts project that is described in the [Using Data Shortcuts tutorial](#) (page 183).

For more information, see the AutoCAD Civil 3D Help topic *Importing a Project*.

This exercise continues from [Exercise 1: Exporting a Vault Project](#) (page 211).

Import a project

- 1 In Toolspace, on the Prospector tab, right-click Projects node ► Import From ► Folder.

Notice that you can also import from a ZIP file. Typically, you would use this option to import a project that had been exported from Vault.

- 2 In the Browse For Folder dialog box, navigate to the [My Civil Tutorial Data folder](#) (page 819). Select Tutorial Data Shortcuts Project. Click OK.

You see a progress bar and several command-line messages about the operation. When the project is imported, it appears in the Projects collection on the Prospector tab, and a copy is created in your working folder Tutorial Data Shortcuts Project is now a Vault project.

Alignments Tutorials

8

These tutorials will get you started working with horizontal alignments, which are the basis for modeling roads.

NOTE All drawings used in these tutorials are available in the [tutorial drawings folder](#) (page 819). If you want to save your work from these tutorials, save the drawings to the [My Civil Tutorial Data folder](#) (page 819) so that you do not overwrite the original drawings.

For more information, see the AutoCAD Civil 3D Help topic *Alignments*.

Tutorial: Creating Alignments

This tutorial demonstrates how to create and modify alignments.

You begin creating an alignment by marking the location of tangents and points of intersection for a road centerline alignment. During the creation process, curves between the tangents can be created automatically, or added later. To accommodate high-speed travel, spirals and superelevation can be added to the curves. You can enter numeric parameter values for lines, curves, and spirals in the Alignment Entities table.

If your alignment design must meet minimum standards, you can apply design criteria to an alignment either before or after it is created. This tutorial demonstrates basic alignment creation tasks. For information on applying design criteria to an alignment, see the [Designing an Alignment Using Local Standards](#) (page 248) tutorial.

For more information, see the AutoCAD Civil 3D Help topic *Creating Alignments*.

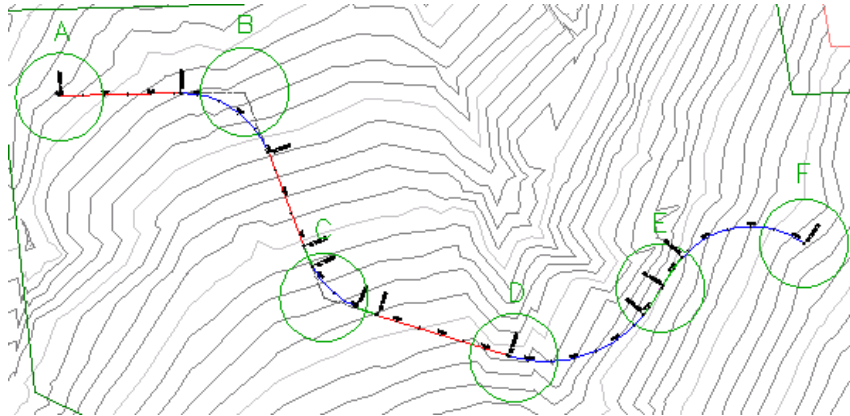

Exercise 1: Creating an Alignment with the Alignment Layout Tools

In this exercise, you will use the alignment layout tools to draw an alignment that has curves.

For more information, see the AutoCAD Civil 3D Help topic *Creating an Alignment Using the Alignment Layout Tools*.

Specify alignment properties

- 1 Open *Align-1.dwg*, which is located in the [tutorial drawings folder](#) (page 819).

The drawing contains a surface marked with several circles, labeled A through D.

NOTE Ensure that Object Snap (OSNAP) is turned on. For more information, see [Object Snapping](#) (page 16).

- 2 Click Home tab ► Create Design panel ► Alignment drop-down ► Alignment Creation Tools .
- 3 In the Create Alignment – Layout dialog box, for Name, enter First Street.
- 4 On the General tab, select the following settings:
 - Site: <None>
 - Alignment Style: Layout

- Alignment Layer: C-ROAD
- Alignment Label Set: Major Minor and Geometry Points

Setting the site to <None> prevents the alignment from interacting with other objects in the drawing. The <None> selection is helpful when you do not want parcels to be created when either intersecting alignments form closed regions or an alignment crosses an existing parcel.

5 Click the Design Criteria tab.



The Starting Design Speed value specifies the default design speed at the alignment starting station. Design speeds can be specified at other stations along the alignment. If no other design speeds are specified, the Starting Design Speed is applied to the entire alignment. Accept the default Starting Design Speed value for this exercise.

The other options on this tab are used only if you want to ensure that the alignment design meets specified design criteria. You do not apply design criteria to the alignment in this exercise. You will learn how to use the design criteria feature in the [Designing an Alignment that Refers to Local Standards](#) (page 248) tutorial.

6 Click OK.

The Alignment Layout Tools toolbar is displayed. It includes the controls required to create and edit alignments.

Draw the alignment

- 1** In the Alignment Layout Tools toolbar, click the drop-down list  and select  Curve and Spiral Settings. In the Curve and Spiral Settings dialog box, you can specify the type of curve to be automatically placed at every point of intersection (PI) between tangents.
- 2** In the Curve and Spiral Settings dialog box, specify the following parameters:
 - Type: Clothoid
 - Spiral In: Cleared
 - Curve: Selected
 - Spiral Out: Cleared
 - Default Radius: 350.0000'

Exercise 2: Adding Free Curves and Spirals to an Alignment



In this exercise, you will add a free curve and a free spiral-curve-spiral to a simple alignment.

The drawing contains a simple alignment consisting of three tangents. In the next few steps, you will add free curves at circles B and C.



For more information, see the AutoCAD Civil 3D Help topics *Adding Curves* and *Adding Curves with Spirals*.

This exercise continues from [Exercise 1: Creating an Alignment with the Alignment Layout Tools](#) (page 214).

Add a free curve between two tangents

- 1 Open *Align-2.dwg*, which is located in the [tutorial drawings folder](#) (page 819).
- 2 Set your drawing window so that you can see circles B and C on the surface.
- 3 If the Alignment Layout Tools toolbar is not open, select the alignment. Right-click and click Edit Alignment Geometry.
- 4 In the Alignment Layout Tools toolbar, click the drop-down list . Select  Free Curve Fillet (Between Two Entities, Radius).
- 5 As prompted on the command line, click the tangent that enters circle B from the left (the 'first entity').
- 6 Click the tangent that exits from circle B on the right (the 'next entity').
- 7 Press Enter to select the default value of a curve less than 180 degrees.
- 8 Enter a radius value of 200. The curve is drawn between the tangents as specified.

Add a free spiral-curve-spiral between two tangents

- 1 In the Alignment Layout Tools toolbar, click the arrow next to . Select  Free Spiral-Curve-Spiral (Between Two Entities).

- 2 As prompted on the command line, click the tangent that enters circle C from the left (the 'first entity').
- 3 Click the tangent that exits circle C on the right (the 'next entity').
- 4 Press Enter to select the default value of a curve less than 180 degrees.
- 5 Enter a radius value of 200.
- 6 Enter a spiral in length of 50.
- 7 Enter a spiral out length of 50.

NOTE Notice that default values that are shown on the command line.

- 8 Exit the layout command by right-clicking in the drawing area.

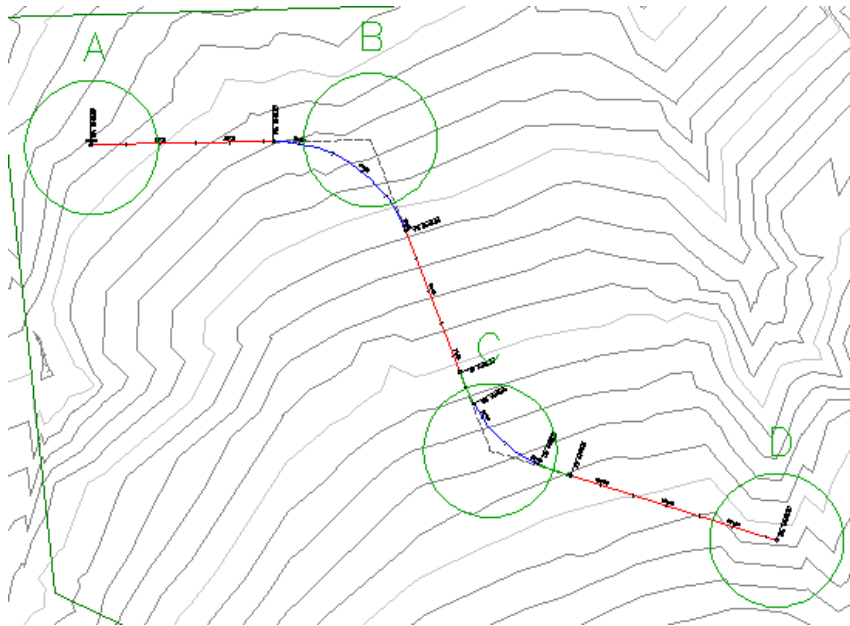

To continue this tutorial, go to [Exercise 3: Adding Floating Curves to an Alignment](#) (page 219).

Exercise 3: Adding Floating Curves to an Alignment

In this exercise, you will add two floating curve entities to a simple alignment. First, you will add a best fit floating curve that follows the most likely path through a series of points. Then, you will add a floating reverse curve with spirals.



The initial drawing shows a simple alignment consisting of three tangents with curves. In the next few steps, you will add two floating curves to the end of the alignment.

For more information, see the AutoCAD Civil 3D Help topic *Adding Lines, Curves, and Spirals to an Alignment*.

This exercise continues from [Exercise 2: Adding Free Curves and Spirals to an Alignment](#) (page 217).



Add a floating curve by best fit to the alignment

NOTE This exercise uses *Align-2.dwg* with the modifications you made in the previous exercise, or you can open *Align-3.dwg* from the [tutorial drawings folder](#) (page 819).

- 1 Pan and zoom until you can see circles D and E on the surface.
 - 2 On the Home tab ► Layers panel, in the Layer Control list, in the C-POINTS row, click  to turn on the C-POINTS layer.
A group of points is displayed. You will use these points as a basis for creating a floating curve that follows the most likely path through the points.
-
- NOTE** If the points do not appear, enter REGEN on the command line.
-
- 3 If the Alignment Layout Tools toolbar is not open, select the alignment. Right-click and click Edit Alignment Geometry.
 - 4 In the Alignment Layout Tools toolbar, click the drop-down list .
Select  Floating Curve - Best Fit.
 - 5 As prompted on the command line, click the tangent that ends in circle D (the 'entity to attach to').
 - 6 In the Curve By Best Fit dialog box, make sure that From COGO Points is selected. Click OK.

The Regression Data vista closes, and the regression point markers disappear.



Modify the best fit curve

- 1 In the drawing, select the alignment. Click the  grip at the end of the floating curve, and drag it toward one of the other points. Click to place the grip in its new location.
- 2 In the Alignment Layout Tools toolbar, click  Edit Best Fit Data For All Entities.

Notice that the original regression data is displayed in the Regression Data vista, and the original best fit curve is displayed in the drawing. The

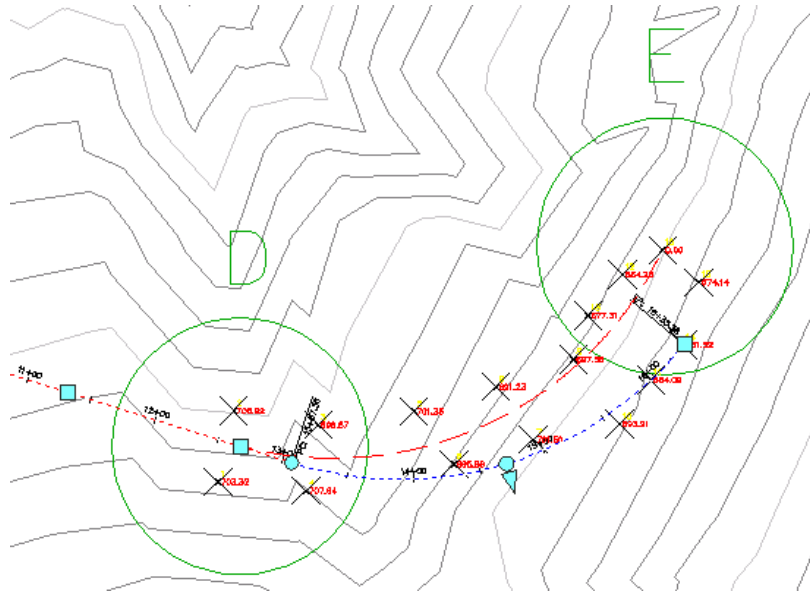
 icon in the Regression Data vista indicates that the alignment layout does not comply with the regression data. When you moved the grip in step 1, you moved the pass-through point from the location you specified earlier.





- 3 Click  to synchronize the entity to the original regression data. Click  to close the Regression Data vista.

The entity returns to its original location.

- 4 On the Home tab ► Layers panel, in the Layer Control list, in the C-POINTS row, click  to turn off the C-POINTS layer.

To add a floating reverse curve with spirals to the alignment

- 1 On the Alignment Layout Tools toolbar, click the arrow next to  .
Select  Floating Reverse Curve with Spirals (From Curve, Radius, Through Point).
- 2 As prompted on the command line, click the curve entity that ends in circle E (the 'curve to attach to').
- 3 Enter a spiral in length of 75.
- 4 Enter a radius of 200.
- 5 Enter a spiral out length of 75.
- 6 Specify a pass-through point in circle F.
The reverse curve with spirals appears.
- 7 Exit the layout command by right-clicking in the drawing.

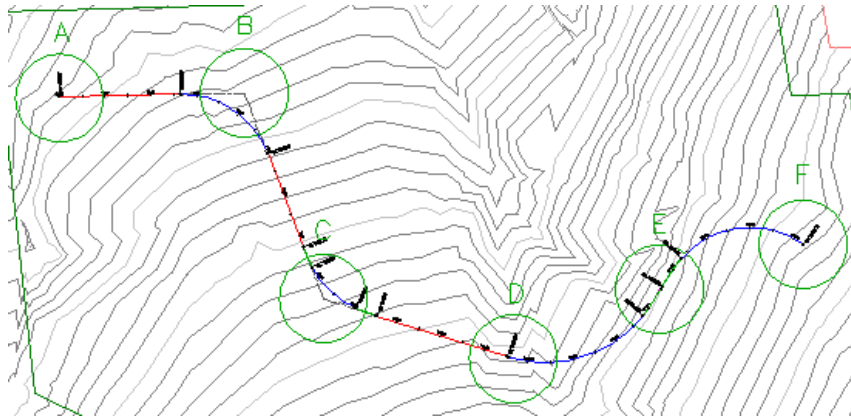

To continue to the next tutorial, go to [Tutorial: Editing Alignments](#) (page 223).

Tutorial: Editing Alignments

This tutorial demonstrates some common editing tasks for alignments.

Editing the layout parameter values of an alignment allows you to make fine adjustments to alignment sub-entities. Grip editing provides a convenient method of manually reshaping an alignment.

For more information, see the AutoCAD Civil 3D Help topic *Editing Alignments*.

Exercise 1: Editing the Layout Parameter Values of an Alignment

In this exercise, you will use the Alignment Entities vista and Alignment Layout Parameters dialog box to edit the layout parameter values of an alignment.

For more information, see the AutoCAD Civil 3D Help topic *Editing Alignment Entity Layout Parameters*.

This exercise continues from the [Creating Alignments](#) (page 213) tutorial.



NOTE Ensure that Dynamic Input (DYN) is turned on. For more information, see the [Dynamic Input](#) (page 17) tutorial.

Open the parametric editing windows

- 1 Open *Align-4.dwg*, which is located in the [tutorial drawings folder](#) (page 819).

The drawing contains a surface marked with several circles, labeled A through F.

NOTE Ensure that Object Snap (OSNAP) is turned on. For more information, see [Object Snapping](#) (page 16).

- 2 If the Alignment Layout Tools toolbar is not open, select the alignment. Click Alignment tab ► Modify panel ► Geometry Editor .
- 3 On the Alignment Layout Tools toolbar, click Alignment Grid View .

Examine the Alignment Entities table in Panorama. In the first column, alignment segments are numbered in the order in which they are solved. Each row of the table shows useful design data about a specific entity.

Each curve group has a two-part entity number and a separate table row for each spiral and curve. Values shown in black can be edited.

- 4 On the Alignment Layout Tools toolbar, click Sub-Entity Editor . The Alignment Layout Parameters window is displayed, containing no data.
- 5 In the Alignment Entities table, click any row for segment no. 4, which is the free spiral-curve-spiral entity in circle C in your drawing window. The design data for all three sub-entities is displayed in a two-column table in the Alignment Layout Parameters window, where data is easy to review and edit.

If your design requires precise values for minimum curve radius, length, or spiral A values, you can use the Alignment Layout Parameters window to enter the values.

- 6 In the Alignment Layout Parameters window, change the Length value for a spiral to a higher number, such as 100, and press Enter. Note how this immediately increases the spiral length in three locations: in both the Alignment Layout Parameters window and the Alignment Entities table, numeric values change; in the drawing window, geometry point labels move and their station values change, and the length of the spiral itself changes.

Further exploration: Experiment with changing the curve radius. In the Alignment Entities table, click a line or curve entity and note the data that you can edit in the Alignment Layout Parameters window.

- 7 Press Esc to clear the Alignment Layout Parameters dialog box.

Display a range of sub-entities in the Alignment Entities vista

- 1 In the drawing, Ctrl+click the curve entity in circle B. The Alignment Entities vista displays only the attributes for the curve entity.
- 2 In the drawing, Ctrl+click the spiral-curve-spiral entity in circle C. Notice that the Alignment Entities vista now displays the attributes for each of the entities you selected, plus the tangent between them. To display the parameters of another entity in the Alignment Layout Parameters dialog box, click the appropriate row in the Alignment Entities vista.
- 3 Press Esc to display all alignment entities on the Alignment Entities vista.

To continue this tutorial, go to [Exercise 2: Grip Editing an Alignment](#) (page 225).

Exercise 2: Grip Editing an Alignment

In this exercise, you will use grips to move alignment curves.

You will learn how to grip edit offset and curb return alignments in the [Working with Offset and Curb Return Alignments](#) (page 232) tutorial.



For more information, see the AutoCAD Civil 3D Help topic *Editing Alignments Using Grips*.

This exercise continues from [Exercise 1: Editing the Layout Parameter Values of an Alignment](#) (page 223).







NOTE Ensure that Dynamic Input (DYN) is turned on, and OSNAP is turned off. For more information, see the [Tutorial: Using Basic Functionality](#) (page 15) tutorial.

Grip edit a free curve entity

NOTE This exercise uses *Align-4.dwg* with the modifications you made in the previous exercise.

- 1 Zoom to the area around circle B.
- 2 Click the alignment. Grips appear at the curve ends, midpoint, and at the point of intersection (PI).
- 3 Click the  midpoint grip at the midpoint of the curve. It turns red.
- 4 Click a new location for the curve to pass through.
Notice that the curves and tangents remain tangent to each other, but both endpoints  move along the tangents.
- 5 Click the radius  grip directly above the pass-through point grip and experiment with moving it.
Notice that this grip affects only the curve radius and constrained to the direction of the radius change.
- 6 Select either an endpoint grip or the PI grip, and experiment with reshaping the curve in different ways.

Grip edit a floating curve entity

- 1 Pan to the area around circles D and E.
- 2 Select the  grip in circle D. It turns red.
- 3 Click a new location for the grip.
Notice that the pass-through point  grip in circle F does not move.
- 4 Select the  pass-through point grip in circle E. It turns red.
- 5 Click a new location for the grip.
Notice that the  pass-through point grip in circle D does not move.
The spiral-curve entity in circle D moves along the preceding tangent to accommodate the new pass-through point.
To see how grip editing affects curve specifications, in the next few steps you will add a segment label to the curve. This label shows curve length and radius. The values update each time you reshape the curve.
Notice that with this type of curve, if you edit the triangular PI grip, the curve radius does not change.
- 6 Click Alignment tab ► Labels & Tables panel ► Add Labels drop-down ► Single Segment  .
- 7 Click the curve in circle D. A label is placed on the curve.
- 8 Press Enter to end the label command.
- 9 Click the curve to activate the grips.
- 10 Edit the curve using the  pass-through point grip.
Notice that while the grip is active, you can use dynamic input to enter a specific pass-through point. You may also enter a specific value in the Alignment Layout Parameters window.
- 11 Press Esc to deselect the alignment. The label shows the new length of the curve.
- 12 Close this drawing.

To continue this tutorial, go to [Exercise 3: Applying a Mask to an Alignment](#) (page 227).

Exercise 3: Applying a Mask to an Alignment

In this exercise, you will hide a portion of an alignment from view.

When you apply a mask to a portion of an alignment, the alignment sub-entities, labels, and marker points are not drawn. These items still exist, but are hidden from view.

This feature is useful when working on an intersection. In many cases, you do not need to see the alignment geometry that passes through the intersection. In this exercise, you will mask the portion of an offset alignment that passes through an intersection.

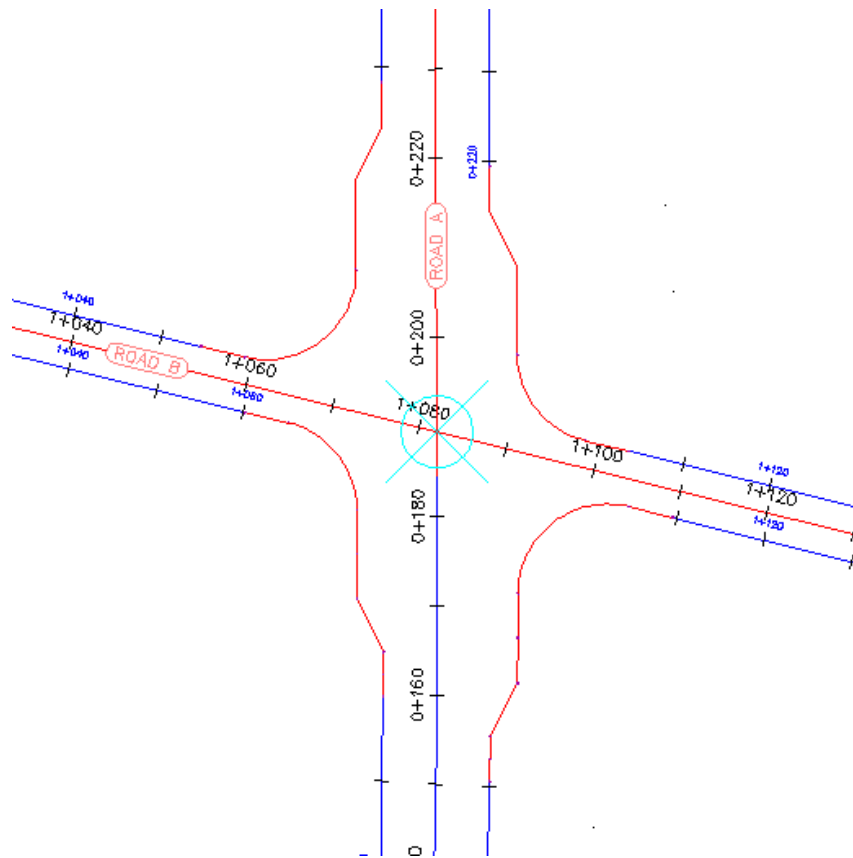

For more information, see the AutoCAD Civil 3D Help topic *Alignment Properties*.

This exercise continues from [Exercise 2: Grip Editing an Alignment](#) (page 225).

Specify the alignment stations to mask

- 1 Open *Align-5.dwg*, which is located in the [tutorial drawings folder](#) (page 819).

The drawing contains a four-way intersection. Notice that the offset alignments along Road A are not displayed in the intersection area. Each of these alignments has a mask applied to the region that passes through the intersection. In the following steps, you will apply a mask to the offset alignments along Road B.

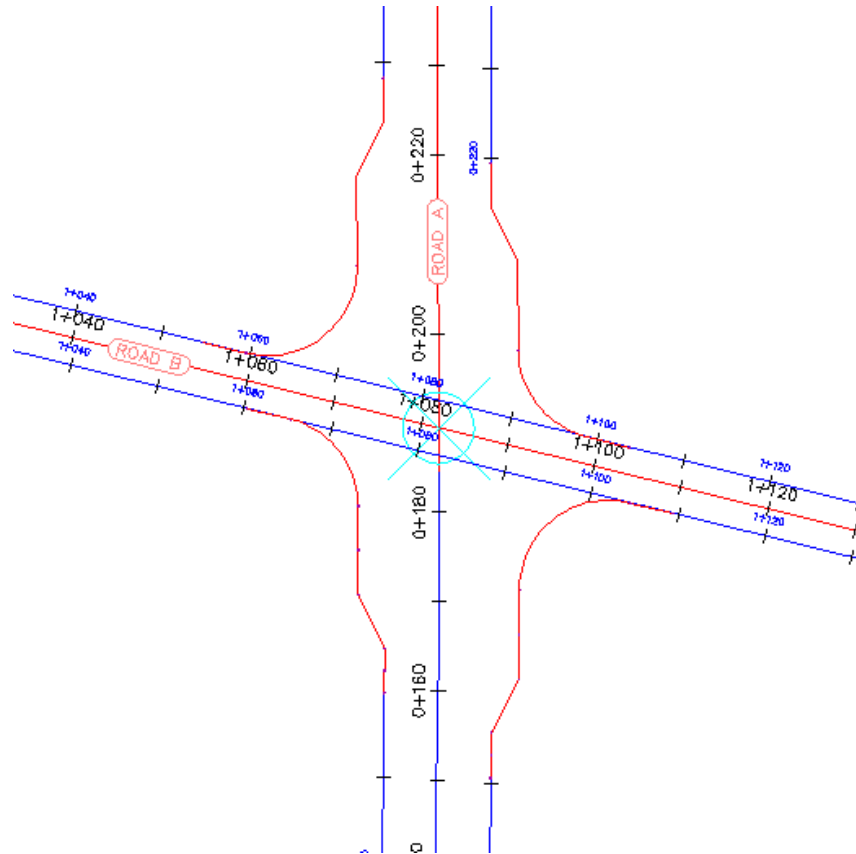

- 2 Select the offset alignment on the north side of Road B.
- 3 Click Offset Alignment tab ► Modify panel ► Alignment Properties drop-down ► Alignment Properties .

- 4 In the Alignment Properties dialog box, click the Masking tab.
- 5 On the Masking tab, click .
- 6 In the drawing, click the end point on the northwest curb return to specify the start point of the masked region.

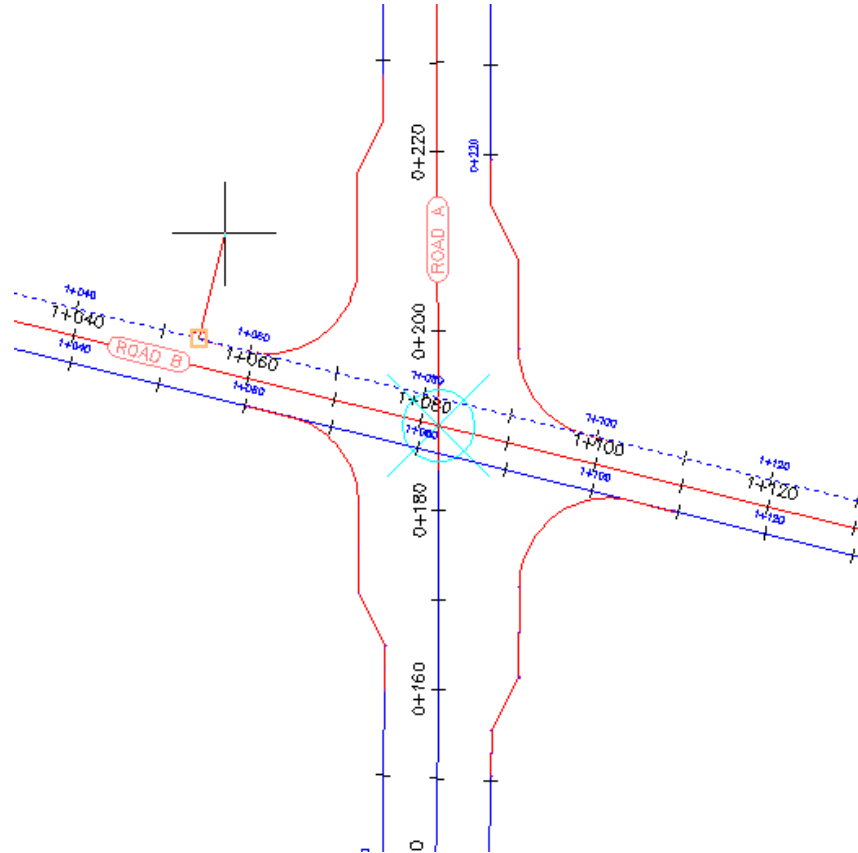

- 7 Click the end point on the northeast curb return to specify the end point of the masked region.

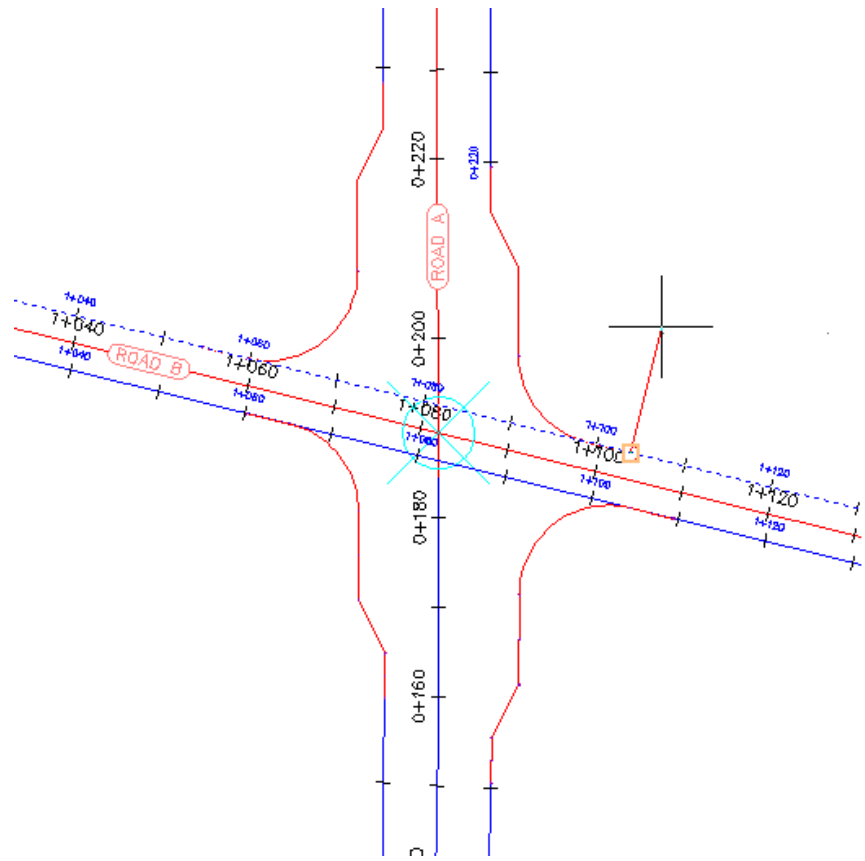

- 8 In the Alignment Properties dialog box, click Apply.
The mask is applied to the specified region.

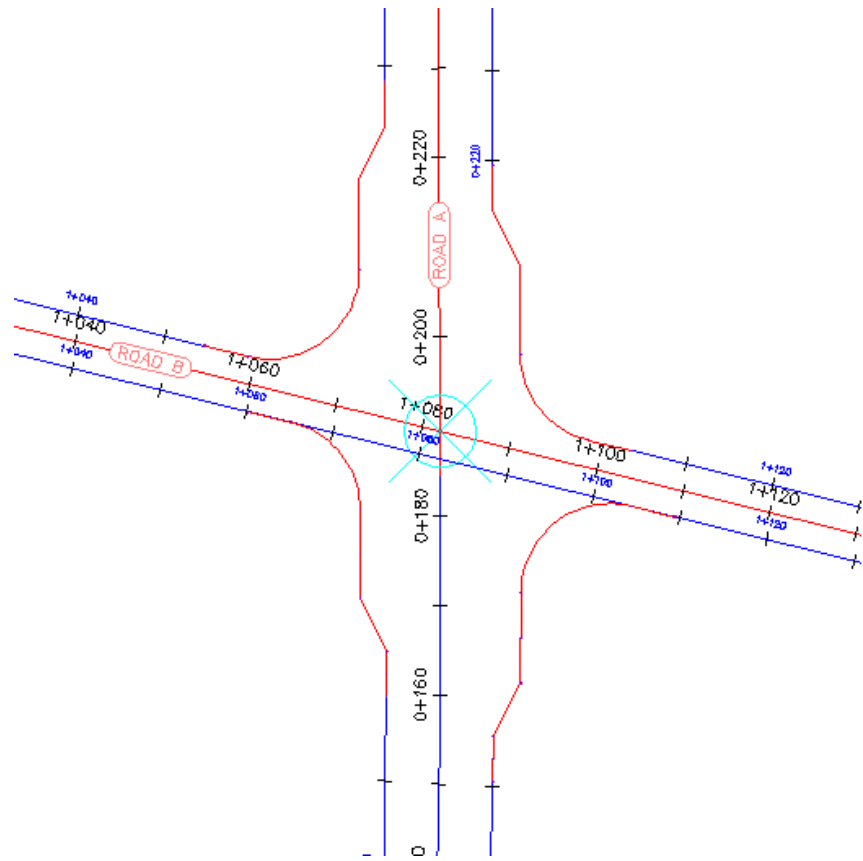

Further exploration: Apply masks to the west-to-east road offset alignments.

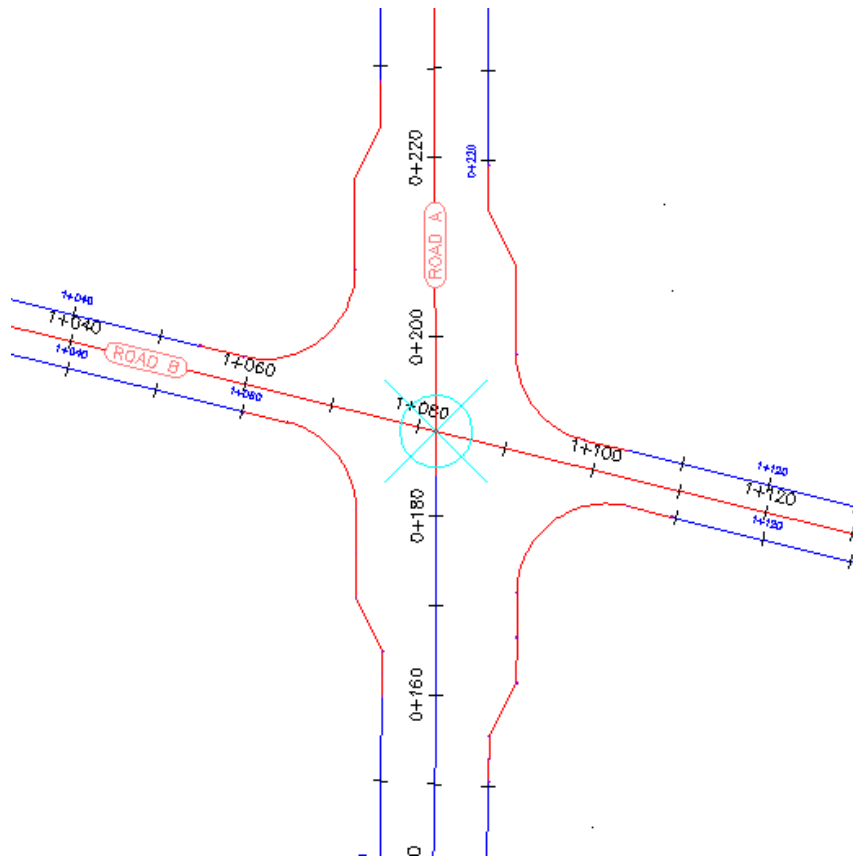

To continue to the next tutorial, go to [Working with Offset Alignments](#) (page 232).

Tutorial: Working with Offset Alignments

This tutorial demonstrates how to create and modify offset alignments that are dynamically linked to a centerline alignment.

The process of creating offset alignments is similar to that of the standard AutoCAD OFFSET command. However, an offset alignment is dynamically linked to either the geometry or stationing of the centerline alignment from which it was created. As the parent alignment geometry changes, the offset alignment updates.

When your design requires a varying offset value, you can add widening regions to an offset alignment. This option is useful in roadway design, when you must add turn lanes, bus bays, or parking lanes.

Add widening regions to a new or existing offset alignment.

NOTE Most of the procedures in this tutorial can be applied to adding widening regions to curb return alignments, which are automatically generated as part of the intersection creation process.

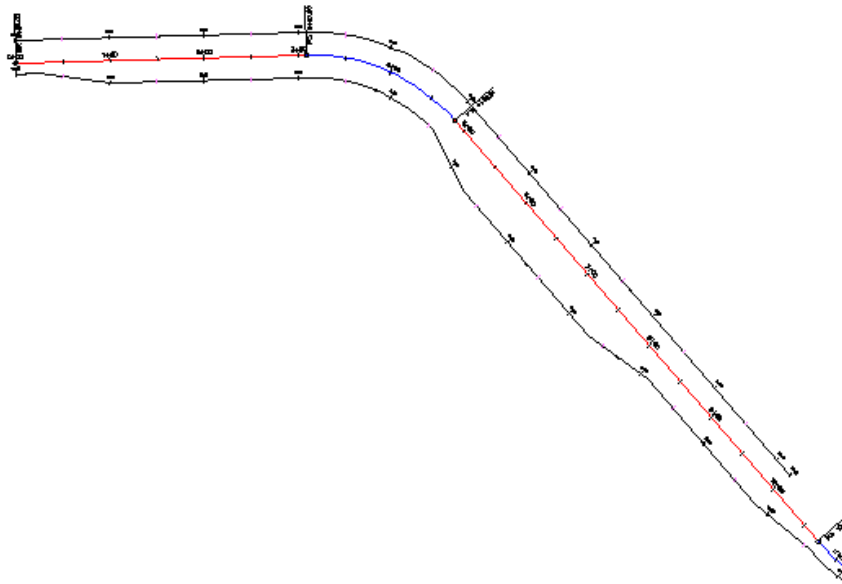

For more information, see the AutoCAD Civil 3D Help topic *Creating Offset Alignments*.

Exercise 1: Creating Offset Alignments

In this exercise, you will create dynamic offset alignments for an existing centerline alignment.

For more information, see the AutoCAD Civil 3D Help topic *Creating Offset Alignments*.

Create offsets of a centerline alignment

- 1 Open *Align-6A.dwg*, which is located in the [tutorial drawings folder](#) (page 819).
The drawing contains a surface and an alignment.
- 2 Click Home tab ► Create Design panel ► Alignment drop-down ► Create Offset Alignment .
- 3 Select the alignment in the drawing.

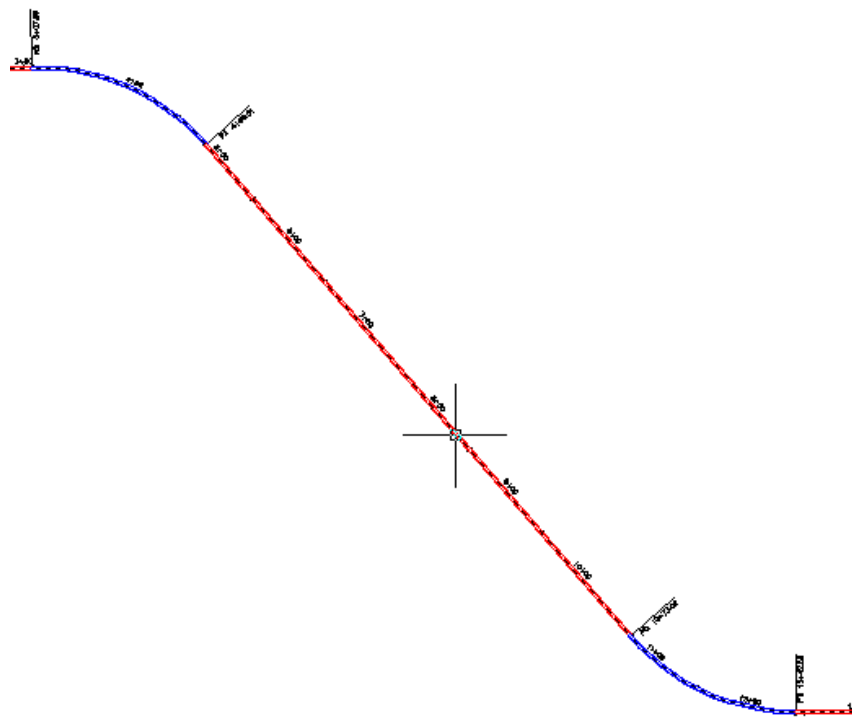

- 4 In the Create Offset Alignments dialog box, specify the following parameters:
 - No. Of Offsets On Left: 1



- No. Of Offsets On Right: 1
- Incremental Offset On Left: 12
- Incremental Offset On Right: 12
- Alignment Style: ETW
- Alignment Label Set: Offset Labels

You can also specify design criteria for the offset alignments.

5 Click OK.

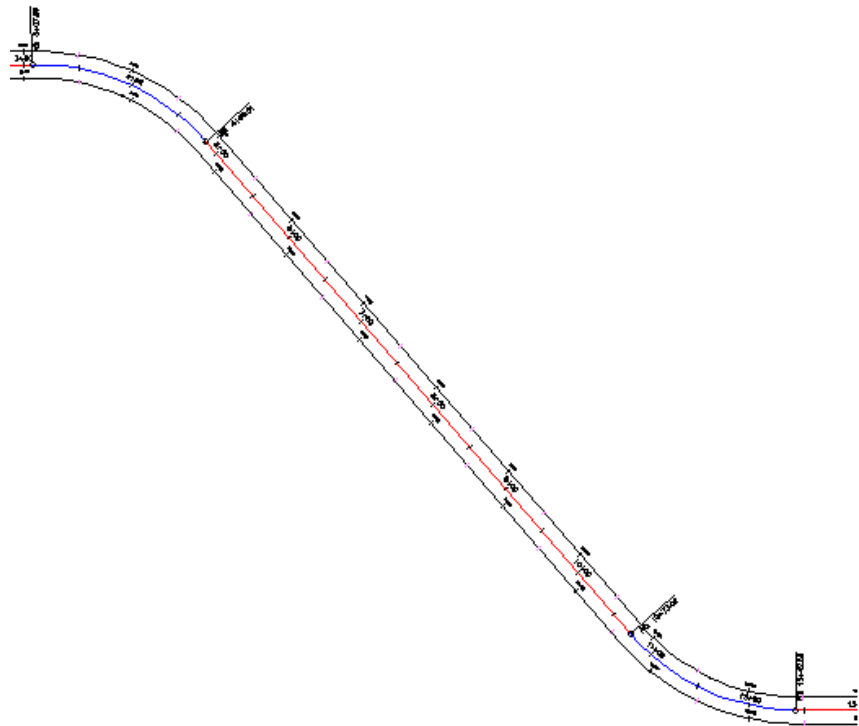
An offset alignment is created on either side of the centerline alignment.



- 6 In Toolspace, on the Prospector tab, expand the  Alignments  Offset Alignments collection.
Notice that the two alignments you created were placed in the Offset Alignments collection. You can create profiles, profile views, and sample line groups from offset alignments, just as you can for standard, Centerline alignments.

To continue this tutorial, go to [Exercise 2: Editing an Offset Alignment](#) (page 236).

Exercise 2: Editing an Offset Alignment

In this exercise, you will examine the offset alignment editing tools.

The geometry editing tools that are available for an offset alignment depend on whether the alignment is static or dynamic. If the offset alignment is dynamically linked to the parent centerline alignment, then you cannot edit the offset alignment geometry. If the offset alignment is static, then you can use the tools on the Alignment Layout Tools toolbar.

An Offset Parameters tab is available in the Alignment Properties dialog box. From this location, you can change parameters such as nominal offset value and start and end stations.

For more information, see the AutoCAD Civil 3D Help topic *Editing Offset Alignments and Widening*.

This exercise continues from [Exercise 1: Creating Offset Alignments](#) (page 233).

Examine the offset alignment geometry

- 1 Open *Align-6B.dwg*, which is located in the [tutorial drawings folder](#) (page 819).
The drawing contains a surface and a centerline alignment with two offset alignments.
- 2 Select the left offset alignment.

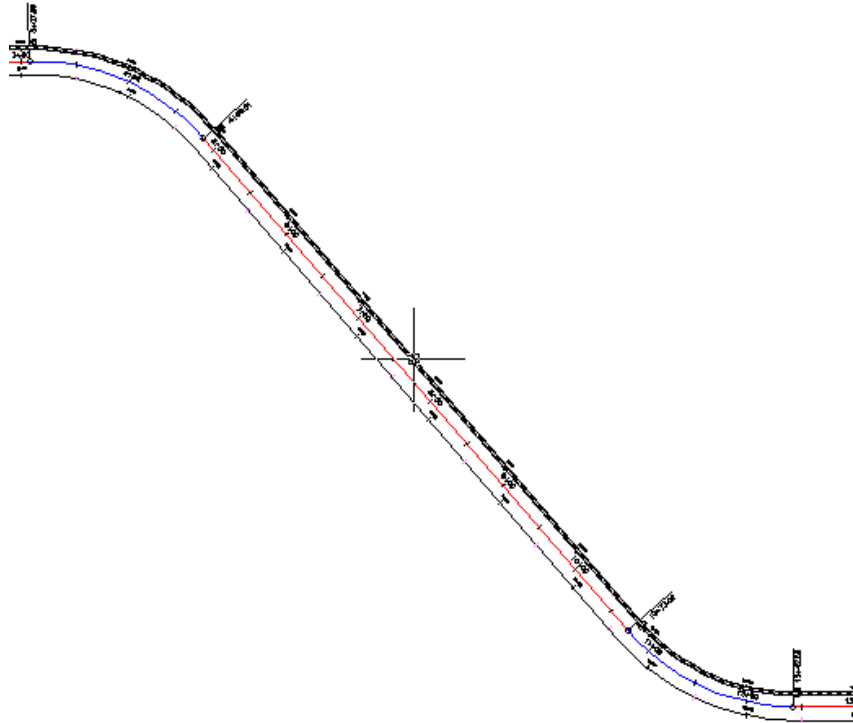

- 3 Click Offset Alignment tab ► Modify panel ► Geometry Editor  .
On the Alignment Layout Tools toolbar, most tools are not available, because the offset alignment geometry is dynamically linked to the parent alignment. You can use the Alignment Entities vista and Alignment Layout Parameters window to view the parameters of a dynamic offset alignment, but you cannot change the values.

Edit the offset alignment parameters

- 1 Click Offset Alignment tab ► Modify panel ► Alignment Properties drop-down ► Alignment Properties  .

- 2 In the Alignment Properties dialog box, on the Information tab, expand the Type list.

You can change an offset alignment to any of the types in this list. However, if you change the alignment type, the alignment will not be dynamically linked to the centerline alignment. For information about the differences between the alignment types, see the AutoCAD Civil 3D Help topic *Alignment Properties*.

- 3 Press Esc.

- 4 Click the Offset Parameters tab.

You use this tab to refine the offset alignment design. If you do not want the offset alignment to react to changes in the parent alignment geometry, use the Update Mode list to make the alignment static.

NOTE The Offset Parameters tab is displayed in the Alignment Properties dialog box only for offset alignments.

- 5 Specify the following parameters:

- Nominal Offset Value: -24.0000
- End Station: 10+00

- 6 Click OK.

The offset alignment now ends at station 10+00, and is offset twice as much as the offset alignment on the opposite side of the centerline.

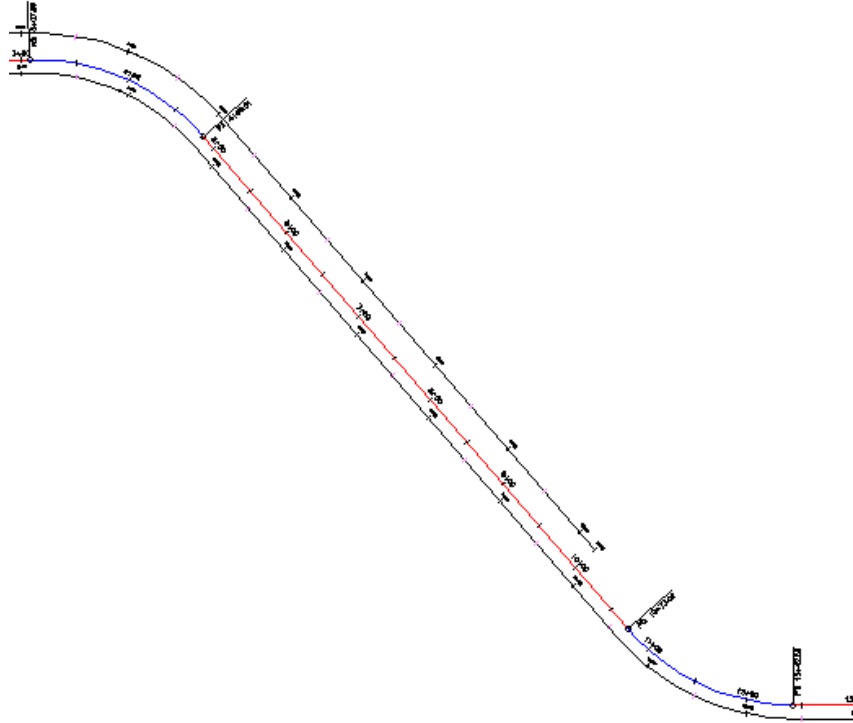

Further exploration: Experiment with the centerline alignment grips. Notice that when you change the centerline alignment geometry, the geometry of the offset alignment automatically updates.

To continue this tutorial, go to [Exercise 3: Adding a Widening to an Offset Alignment](#) (page 239).

Exercise 3: Adding a Widening to an Offset Alignment

In this exercise, you will add dynamic widening regions between specified stations of an offset alignment.

Widening regions are useful for creating bus bays, medians, turn lanes, and parking lanes.

For more information, see the AutoCAD Civil 3D Help topic *Widenings*.

This exercise continues from [Exercise 2: Editing an Offset Alignment](#) (page 236).

Create a widening on an offset alignment

- 1 Open *Align-6C.dwg*, which is located in the [tutorial drawings folder](#) (page 819).

The drawing contains a surface and a centerline alignment with two offset alignments.

- 2 Select the offset alignment on the right-hand side of the centerline alignment.

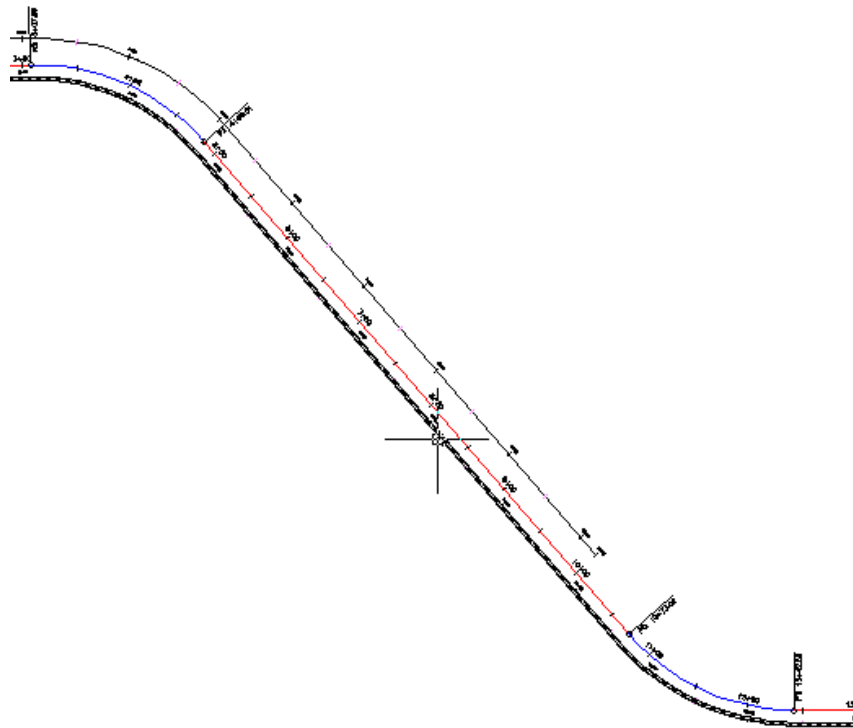

- 3 Click Offset Alignment tab ► Modify panel ► Add Widening .
- 4 Follow the command line prompts to specify the following parameters:
 - Create Widening Portion As A New Alignment?: No
 - Start Station: 150
 - End Station: 1000
 - Widening Offset: 24

The widening region is created, and the parameters you entered are displayed in the Offset Alignment Parameters dialog box. You will learn how to use this dialog box and the grips to modify the offset alignment in [Exercise 4: Editing an Offset Widening](#) (page 243).

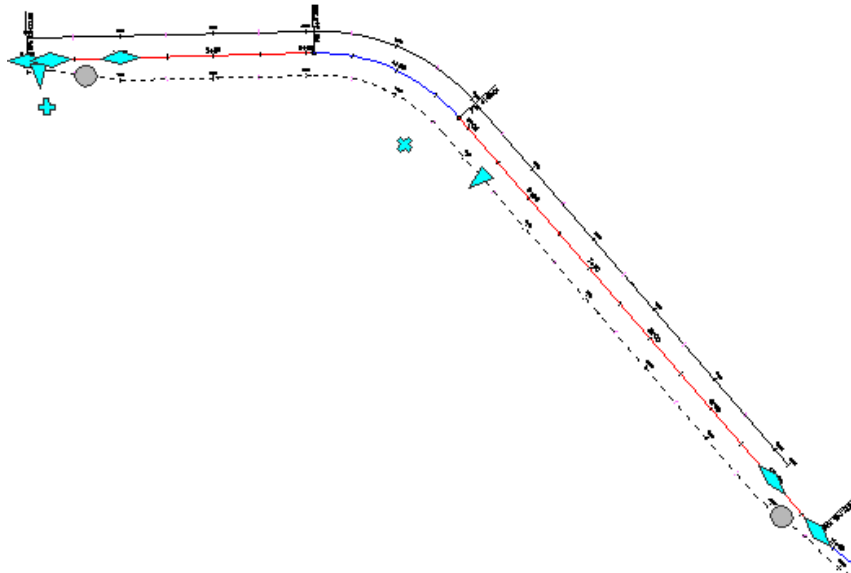

Add a widening region to a widening region

- 1 Select the offset alignment that is on the right-hand side of the centerline alignment. Right-click. Click Edit Offset Parameters.

NOTE You can also use the  grip to add a widening region.

The offset alignment parameters, including the parameters of the existing widening, are displayed in the Offset Alignment Parameters dialog box.

- 2 In the Offset Parameters dialog box, click Add A Widening.
- 3 Follow the command line prompts to specify the following parameters:
 - Start Station: 550
 - End Station: 750
 - Widening Offset: 42
- 4 Press Esc to deselect the offset alignment.

The second widening region is created within the original widening region. The parameters for the new widening region are displayed in the Offset Alignment Parameters dialog box.

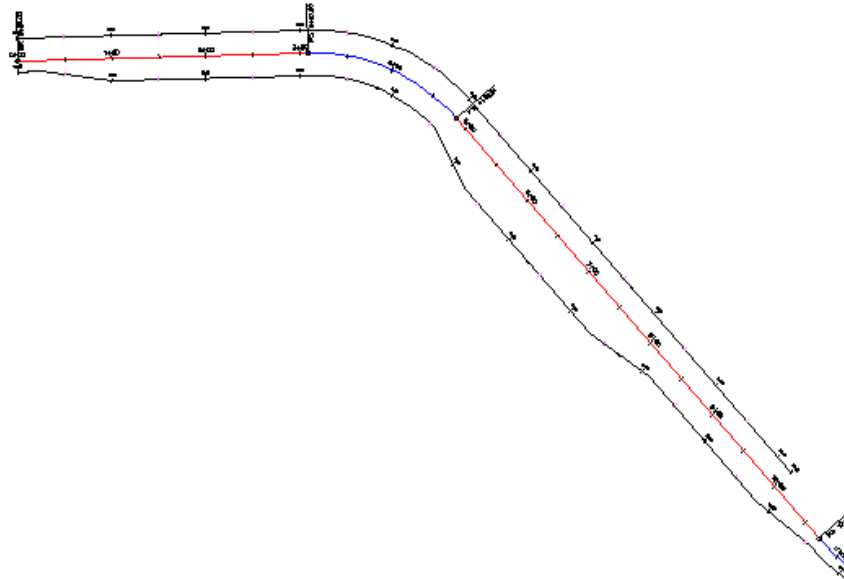

To continue this tutorial, go to [Exercise 4: Editing an Offset Widening](#) (page 243).

Exercise 4: Editing an Offset Widening

In this exercise, you will change the transition between an offset alignment and its widening region, and then use grips to modify the widening geometry.

For more information, see the AutoCAD Civil 3D Help topic *Editing Offset Alignments and Widening*s.

This exercise continues from [Exercise 3: Adding a Widening to an Offset Alignment](#) (page 239).

Change the widening transition

- 1 Open *Align-6D.dwg*, which is located in the [tutorial drawings folder](#) (page 819).

The drawing contains a surface and a centerline alignment with two offset alignments. The offset alignment on the right-hand side of the centerline alignment has two widening regions.

- 2 Select the offset alignment that is on the right-hand side of the centerline alignment. Right-click. Click Edit Offset Parameters.

In the Offset Alignment Parameters dialog box, notice that the offset alignment is divided into a series of regions and transitions. Each region represents the offset values of the sequential station ranges along the centerline alignment. The transitions represent the geometry that joins one region to the next.

NOTE The parameters for the first region are displayed in the window. Show the parameters for subsequent regions by using the Select Widening Region list or the arrow buttons.

- 3 In the Offset Alignment Parameters dialog box, click  .
- 4 In the Property column, select each of the Region and Transition entries in turn.
Notice that each region and transition is highlighted in the drawing as you select it.
- 5 Expand the Transition Out category.
- 6 Change the Transition Type from Linear to Curve-Line-Curve.
The transition changes to a line with a curve on either end.

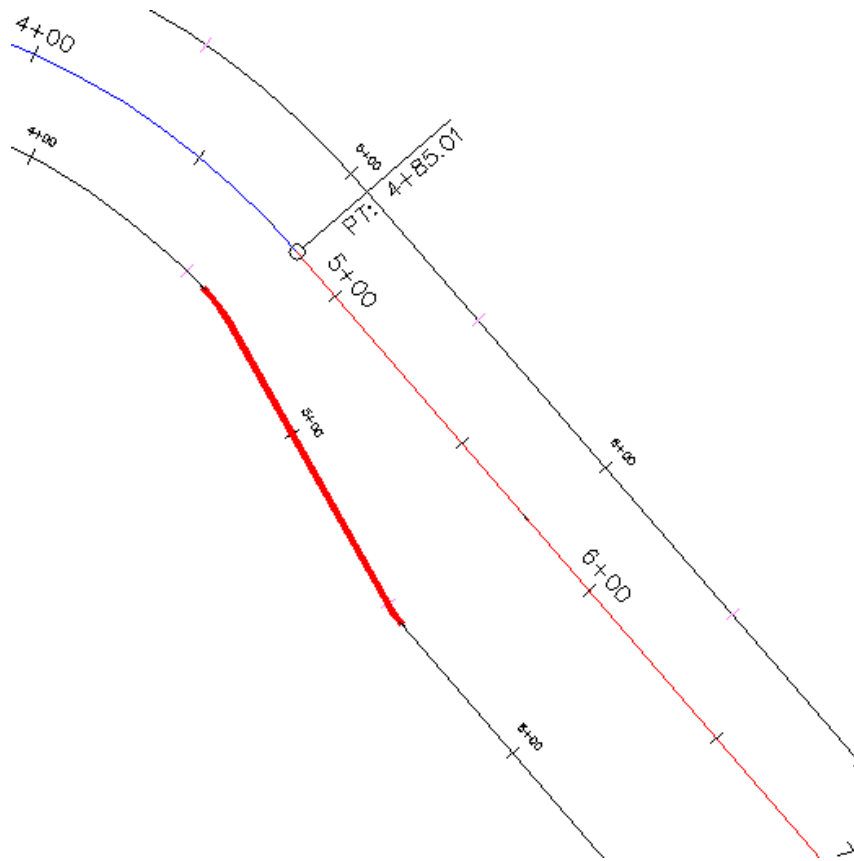

- 7 Under Transition Parameters, for Transition Length, enter 50.
The transition updates to reflect your changes.

Grip edit the widening region

- 1 On the centerline alignment, select the  widening start grip near Station 4+50. The grip turns red.
- 2 Click to place the grip at Station 5+00.
Notice that when you changed the starting location of the widening, the transition moved with it, while its parameters were maintained.

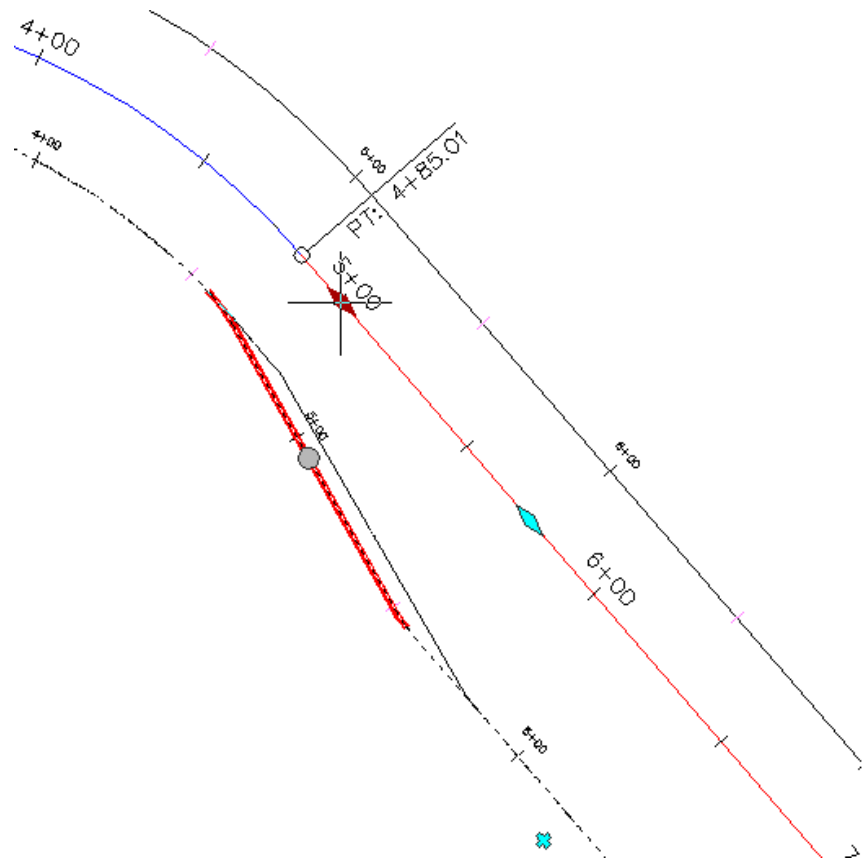

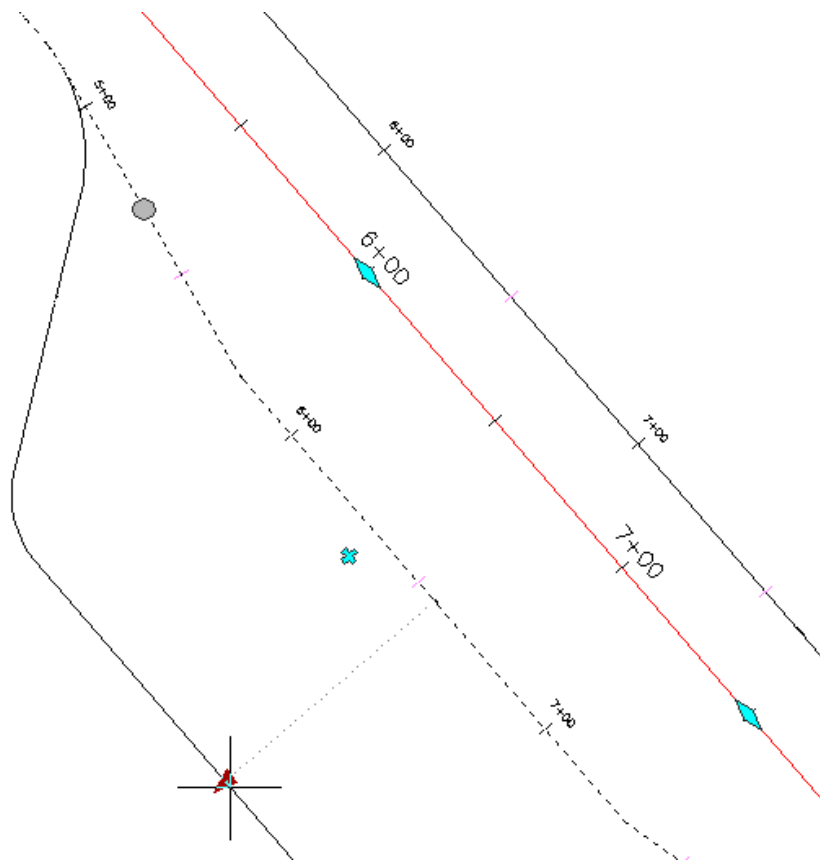

- 3 On the offset alignment, click the  offset grip. The grip turns red.
- 4 While the grip is active, enter 50 as the new offset value.
The widening region expands to accommodate the new offset value.



NOTE The  grip enables you to add another widening region.

5 Click the  grip.

The  grips are now gray, and  grips are displayed at the beginning and end of each transition sub-entity. These grips are used to modify the transition geometry.

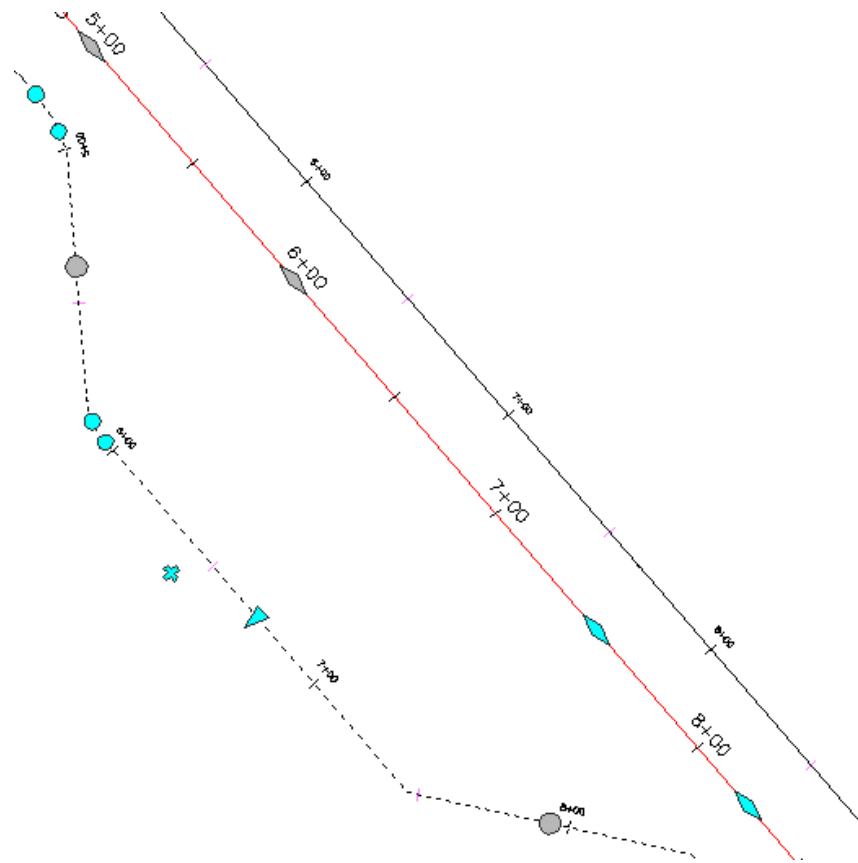

- 6 Experiment with using the  grips to change the transition geometry. As you grip-edit the transition geometry, notice that the applicable parameter values are automatically updated in the Offset Parameters dialog box.

To continue to the next tutorial, go to [Designing an Alignment that Refers to Local Standards](#) (page 248).

Tutorial: Designing an Alignment that Refers to Local Standards

This tutorial demonstrates how to validate that your alignment design meets criteria specified by a local agency.

To create an alignment using design criteria, you use the same basic workflow that you use to create an alignment without design criteria. During alignment creation, you can select a design criteria file, from which you can specify the superelevation attainment method and minimum radius and transition (spiral) length tables. Design criteria files that contain AASHTO design standards are included with AutoCAD Civil 3D. If your local design standards differ from the AASHTO standards, you can create a custom design criteria file using the Design Criteria Editor dialog box.

Some alignment design criteria is not available in table form in the design criteria file. For these criteria, you can define design checks to validate design standards. To apply a design check to an alignment, you must add it to a design check set.

If the design parameters for a sub-entity violate a design check or the minimum values established in the design criteria file, a warning symbol appears on the sub-entity in the drawing window, and next to the violated value in the Alignment Entities vista and Alignment Layout Parameters dialog box. When you hover the cursor over a warning symbol, a tooltip displays the standard that has been violated. The display of the warning symbol is controlled by the alignment style.

NOTE You can also use the Design Criteria tab on the Alignment Properties dialog box to apply design criteria to an alignment after it has been created.

For more information, see *Criteria-Based Alignment Design*.

Exercise 1: Drawing an Alignment that Refers to Design Criteria

In this exercise, you will use the criteria-based design tools to create an alignment that complies with specified standards.

This exercise is divided into two parts:

- First, you will specify design criteria for an alignment as you create it, and then draw a series of alignment entities that violate the design criteria.

You will correct the violations in [Exercise 2: Viewing and Correcting Alignment Design Criteria Violations](#) (page 253).

- Second, you will create an alignment entity that meets the design criteria specified in the design criteria file. You will use the minimum default values that are displayed on the command line to ensure that the entity meets the specified design criteria.

For more information, see the AutoCAD Civil 3D Help topic *Creating an Alignment Using the Alignment Layout Tools*.

Specify design criteria for an alignment

- 1 Open *Align-7A.dwg*, which is located in the [tutorial drawings folder](#) (page 819).

The drawing contains a surface marked with several circles, labeled A through E.

NOTE Ensure that Object Snap (OSNAP) is turned on. For more information, see [Object Snapping](#) (page 16).

- 2 Click Home tab ► Create Design panel ► Alignment drop-down ► Alignment Creation Tools .
- 3 In the Create Alignment – Layout dialog box, accept the default values for Name and Starting Station. Leave the Description field blank for this exercise.
- 4 On the General tab, specify the following parameters:
 - Site: <None>
 - Alignment Style: Design Style
 - Alignment Layer: C-ROAD
 - Alignment Label Set: Major Minor and Geometry Points
- 5 On the Design Criteria tab, for Starting Design Speed, enter 50 km/h. This speed will be applied to the starting station of the alignment. You can add design speeds as needed to other stations. A design speed is applied to all subsequent stations until either the next station that has an assigned design speed or the alignment ending station.
- 6 Select the Use Criteria-Based Design check box.

When this option is selected, the criteria-based design tools are available. There are two check boxes that are selected by default:

- Use Design Criteria File—The design criteria file is an XML file that contains minimum design standards for alignment and profile objects. The design criteria file can be customized to support local design standards for design speed, superelevation, and minimum speed, radius, and length of individual entities. The Default Criteria table lists the properties that are included in the default design criteria file, the location of which is displayed in the field above the Default Criteria table.
You will learn more about the design criteria file in [Exercise 4: Modifying a Design Criteria File](#) (page 259).
- Use Design Check Set—Design checks are user-defined formulas that verify alignment and profile parameters that are not contained in the design criteria file. Design checks must be included in a design check set, which is applied to an alignment or profile.

- 7 In the Use Design Criteria File area, click .
- 8 In the Select Design Speed Table dialog box, select *_Autodesk Civil 3D Metric Roadway Design Standards.xml*. Click Open.
For this exercise, you will use AASHTO 2001 standards, which are included in the provided design criteria files. You will learn about creating a custom design criteria file in [Exercise 4: Modifying a Design Criteria File](#) (page 259).
- 9 In the Default Criteria table, in the Minimum Radius Table row, change the Value to AASHTO 2001 eMax 6%.
- 10 In the Use Design Check Set list, select 50kmh Roadway Length Checks. Click OK.
This design check set contains a simple design check. You will create another design check and add it to this design check set in [Exercise 3: Working with Design Checks](#) (page 256).

Draw alignment entities that meet the specified design criteria

- 1 On the Alignment Layout Tools toolbar, click  Tangent-Tangent (No Curves).
- 2 Snap to the center of Circle A to specify a start point for the alignment. Stretch a line out, and specify additional PIs by snapping to the center

of Circles B, C, and D (in order). Then, right-click to end the horizontal alignment layout command.

3 On the Alignment Layout Tools toolbar, click  Free Spiral-Curve-Spiral (Between Two Entities).

4 As prompted on the command line, click the tangent entity that enters Circle B from the left (the 'first entity').

5 Click the tangent that exits Circle B on the right (the 'next entity').



6 Press Enter to accept the default value of a curve solution angle that is less than 180 degrees.

7 For radius, enter 75.

Notice that the Specify Radius prompt includes a default value. This value is the minimum acceptable curve radius at the current design speed. The minimum value is contained in the Minimum Radius Table in the design criteria file. You can enter a different value, as long as it is greater than the default minimum value that is displayed. For this exercise, you will use values that do not meet the design criteria, and then examine the results.

8 For spiral in length, enter 25.

9 For spiral out length, enter 25.

10 In the Alignment Layout Tools toolbar, click the drop-down list .
Click  Free Curve Fillet (Between Two Entities, Radius).

11 As prompted on the command line, click the tangent that enters Circle C from the left (the 'first entity').

12 Click the tangent that exits from Circle C on the right (the 'next entity').

13 Press Enter to select the default value of a curve less than 180 degrees.

14 Press Enter to select the minimum radius of 90.000m.

15 Right-click to end the command.

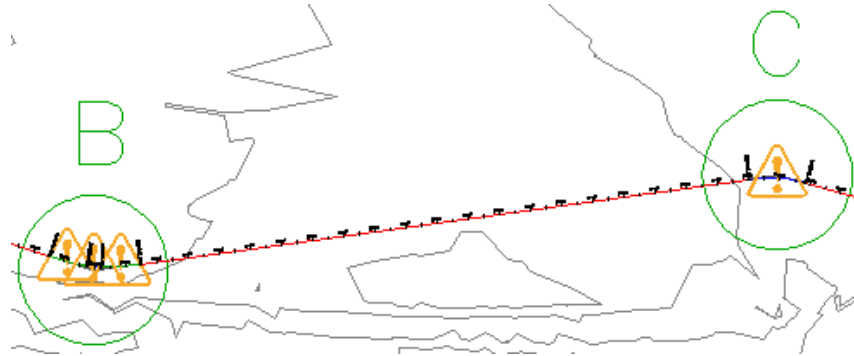

Notice that in the drawing window,  symbols appear on the curve entities you created. The symbols indicate that the entities violate the specified design criteria. You will learn how to correct these violations in [Exercise 2: Viewing and Correcting Alignment Design Criteria Violations](#) (page 253).

In step 14, you accepted the minimum radius value specified in the design criteria file, yet a warning symbol is displayed on the curve. This happened because while the curve meets the design criteria specified in the design criteria file, it violates the design check that is in the design check set. You will learn how to correct design criteria and design check violations in the next exercise.



Next, you will add another curve entity and examine the results.

Add a sub-entity that meets design criteria

- 1 On the Alignment Layout Tools toolbar, click the drop-down list .
Select More Floating Curves >  Floating Curve (Entity End, Radius, Length).
- 2 As prompted on the command line, click the tangent entity that ends in Circle D (the 'entity to attach to').

TIP The warning symbols do not automatically scale when you zoom in. Enter REGEN on the command line to resize the warning symbols.

- 3 On the command line, enter O to specify the counterclockwise direction.
- 4 Enter a radius value of 200.000m.
- 5 When prompted to specify a curve length, click in the center of Circle D, and then click in the center of Circle E.
The curve is displayed in the drawing. The length value is the distance between the two points that you clicked.
- 6 Right-click to end the command.

Notice that a warning symbol is not displayed on this curve. The radius value you entered in step 4 exceeds the minimum value defined in the minimum radius table that you specified.

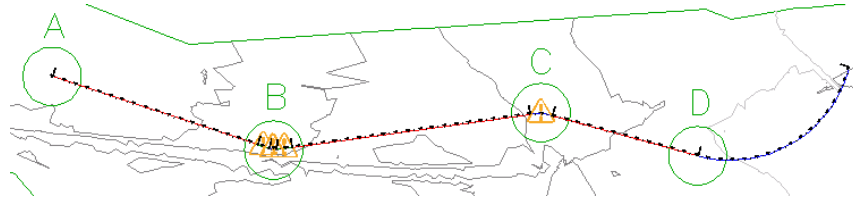

To continue this tutorial, go to [Exercise 2: Viewing and Correcting Alignment Design Criteria Violations](#) (page 253).

Exercise 2: Viewing and Correcting Alignment Design Criteria Violations

In this exercise, you will examine alignment design criteria violations, and then learn how to correct a criteria violation.

When a sub-entity violates either a criteria or design check, a warning symbol is displayed on the sub-entity in the drawing window, Alignment Entities vista, and Alignment Layout Parameters dialog box. When the cursor is hovered over a warning symbol in the drawing window, a tooltip displays information about the violation. If a design criteria has been violated, the tooltip displays the criteria that has been violated, as well as the minimum value required to meet the criteria. If a design check has been violated, the tooltip displays the name of the design check that has been violated.

For more information, see *Viewing and Correcting Alignment Design Criteria Violations*.

This exercise continues from [Exercise 1: Drawing an Alignment that Refers to Design Criteria](#) (page 248).

Check the alignment design for criteria violations

- 1 Open *Align-7B.dwg*, which is located in the [tutorial drawings folder](#) (page 819).
- 2 Pan and zoom until you can see Circles B and C on the surface.

TIP The warning symbols do not automatically scale when you zoom in. Enter `REGEN` on the command line to resize the warning symbols.

- 3 Hover the cursor over the middle  symbol in Circle B.

The tooltips are a convenient way to review design criteria violations in the drawing window. Two violations are displayed in the tooltip:



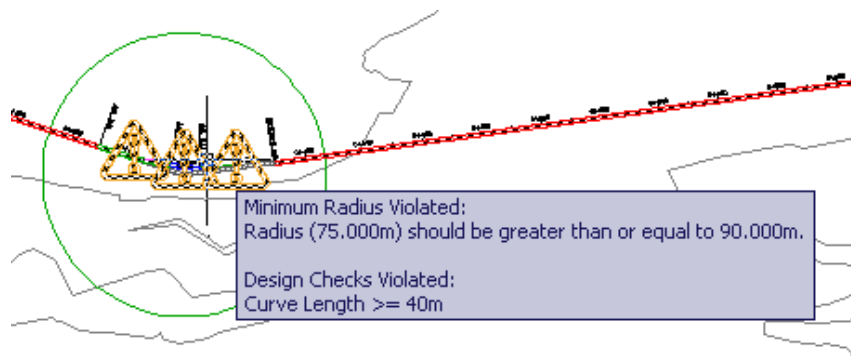

- First, the curve does not meet the recommended minimum radius. The curve radius and minimum acceptable parameter values are both displayed.
- Second, the curve violates a design check that has been applied to the alignment. Notice that the name of the design check is displayed, but not the current or recommended values. Values are not displayed because design checks are custom formulas that are created by the user.



NOTE If a sub-entity violates multiple criteria or design checks, only a single symbol is displayed on the sub-entity. To clear a symbol from a sub-entity, all the violations must be cleared.

- 4 If the Alignment Layout Tools toolbar is not open, select the alignment. Right-click. Click Edit Alignment Geometry.
- 5 On the Alignment Layout Tools toolbar, click Alignment Grid View .

In the Alignment Entities vista, in rows 2.1 through 2.3, a  warning symbol appears in the No. column, as well as in several other columns. Warning symbols appear next to each value that violates the design criteria that are specified in the design criteria file.

- 6 In row 2.2, hover the cursor over the  warning symbol in the No. column.
Notice that the tooltip displays the design criteria and design checks that have been violated.
- 7 Hover the cursor over the  warning symbol in row 4.
Notice that the name of the design check that has been violated is displayed in the tooltip. Also notice that warning symbols are not displayed in any other cells in this row. Design checks are custom mathematical formulas that return either a true or false value. They indicate whether the applicable entities violate the conditions in the design check, but do not specify how to correct the violation. You will learn more about design checks in [Exercise 3: Working with Design Checks](#) (page 256).
- 8 On the Alignment Layout Tools toolbar, click Sub-Entity Editor .
The Alignment Layout Parameters window is displayed, containing no data.
- 9 In the Alignment Entities vista, click any row for segment No. 2, which is the spiral-curve-spiral entity in Circle B.
The design data for all three sub-entities is displayed in a three-column table in the Alignment Layout Parameters window, where data is easy to review and edit.
Notice that in the Alignment Layout Parameters window, in the Design Criteria panel, a  symbol is displayed next to each design criteria property that has been violated. In the Layout Parameters panel, the Value column displays the actual parameters of each sub-entity. The Constraints column displays the design criteria values that the sub-entities must meet. A  symbol is displayed next to each parameter that violates the design criteria. As is true in the drawing window and Alignment Entities Vista, the design check that has been violated is displayed, but individual parameters that violate the check are not marked.

Correct design criteria violations

- 1 In the Alignment Layout Parameters window, on the Layout Parameters panel, change the Spiral In Length Value to 33.000m. Press Enter.
Notice that the warning symbol is cleared from the Spiral In Length row.

- 2 Change the Spiral Out Length Value to 33.000m. Press Enter.
- 3 Change the Curve Radius Value to 100.000m. Press Enter.

The  warning symbol is cleared from the Curve Radius row, as well as from the Alignment Entities vista.

Notice that the warning symbol is still displayed on all the curve sub-entity. The curve still violates the design check. To clear the warning symbols, all sub-entities in the group must meet the values specified in both the design criteria file and the applicable design checks.

- 4 In the Alignment Entities vista, in row 2.2, examine the Length column. Notice that the Length value is less than the value of 40 that is specified by the design check. Notice that you cannot edit the Length value for this type of curve. However, you can increase the curve radius to increase the curve length.
- 5 In row 2.2, change the Radius value to 200.000m. Press Enter.
- 6 In the Alignment Entities vista, select row 4. In the Length column, change the value to 40.000m. Press Enter.

To continue this tutorial, go to [Exercise 3: Working with Design Checks](#) (page 256).

Exercise 3: Working with Design Checks

In this exercise, you will create an alignment design check, add the design check to a design check set, and then apply the design check set to an alignment.

To create a design check, you set up a mathematical formula, using existing alignment sub-entity properties. The complexity of design check formulas can vary greatly. In this exercise, you will create a relatively simple design check that validates whether the tangent length meets a minimum value at a given design speed.

NOTE The processes for creating design checks for alignments and profiles are very similar. The basic workflow that is demonstrated in this exercise can be used for both alignment and profile design checks.

For more information, see *Alignment Design Checks*.

This exercise continues from [Exercise 2: Viewing and Correcting Alignment Design Criteria Violations](#) (page 253).

Create an alignment design check

- 1 Open *Align-7C.dwg*, which is located in the [tutorial drawings folder](#) (page 819).
- 2 In Toolspace, on the Settings tab, expand the Alignment ► Design Checks collection.



Notice that five collections are available. The Design Check Sets collection contains combinations of design checks. A design check must be added to a design check set before it can be applied to an alignment.

The other four collections contain the design checks for each type of alignment entity. Each entity type has specific properties that can be checked. When you create a design check set, you specify the type of entity you want to check, and then the specific design check you want to apply to that entity. You can apply multiple design checks to each entity type.

NOTE The Tangent Intersection collection contains design checks for spiral and curve groups.

- 3 Right-click the Line collection. Click New.
- 4 In the New Design Check dialog box, for Name, enter $L \geq 310\text{m} @ 50\text{km/h}$.

BEST PRACTICE Because design check tooltips do not display specific values, a design check name should be specific and unique. Use the mathematical formula or other specific information to simplify the process of correcting a design check violation.

- 5 For Description, enter Tangent length must be $\geq 310\text{m}$ if design speed is $\geq 50\text{km/h}$.
- 6 Click  Insert Function. Click IF.
The IF function is displayed in the Design Check field.
- 7 Click  Insert Property. Select Design Speed.
- 8 In the Design Check field, use the keypad to enter ≥ 50 , (including the comma) after the {Design Speed} property.

- 9 Click  Insert Property. Select Length.
- 10 In the Design Check field, enter $\geq 310,1$ (including the closing parenthesis).
The following formula should be displayed in the Design Check field:
`IF({Design Speed} \geq 50,Length \geq 310,1)`

NOTE In this formula, the ending numeral 1 specifies that the preceding formula is acceptable. If the entity parameters do not meet the values specified in the formula, a violation is issued.



- 11 Click OK.
- 12 In Toolspace, on the Settings tab, expand the Alignment ► Design Checks ► Line collection.
The design check you created is displayed in the Line collection.

Add a design check to a design check set

- 1 In Toolspace, on the Settings tab, expand the Alignment ► Design Checks ► Design Check Sets collection.
- 2 Right-click the 50kmh Roadway Length Checks design check set. Click Edit.
This is the design check set that is applied to the alignment in the current drawing. Notice that the design checks that are in the selected design check set are displayed in the Toolspace list view.

TIP To create a new, empty design check set, right-click the Design Check Sets collection and click New.

- 3 In the Alignment Design Check Set dialog box, click the Design Checks tab.
The table on this tab lists the design checks that are currently in the design check set. The drop-down lists above the table allow you to add design checks to the set.
- 4 In the Type list, select Line.
- 5 In the Line Checks list, select $L \geq 310m @ 50km/h$, which is the design check that you created in the previous procedure. Click Add. Click OK.

- 6 If the Alignment Layout Tools toolbar is not open, select the alignment. Right-click. Click Edit Alignment Geometry.
- 7 On the Alignment Layout Tools toolbar, click Alignment Grid View  . Click Sub-Entity Editor  .
- 8 In the Alignment Entities vista, select row 5.
- 9 In the Alignment Layout Parameters dialog box, examine the Length value.
In the Design Checks panel, notice that a warning symbol is displayed next to the $L \geq 310\text{m} @ 50\text{km/h}$ design check you created. In the Layout Parameters panel, notice that the Length value is less than the 310 meters specified by the design check.

Further exploration: Increase the length of the line until it meets or exceeds 310 meters. This is a fixed line that was created using the Tangent-Tangent (No Curves) command, so you must move the endpoint grip inside Circle D to increase the length.

To continue this tutorial, go to [Exercise 4: Modifying a Design Criteria File](#) (page 259).

Exercise 4: Modifying a Design Criteria File

In this exercise, you will add a radius and speed table to the design criteria file.

If your local agency standards differ from the standards in the supplied design criteria file, you can use the Design Criteria Editor dialog box to customize the file to support your local standards.





In this exercise, you will add a minimum radius table to an existing design criteria file, and then save the file under a new name.

For more information, see *Design Criteria Files*.

This exercise continues from [Exercise 3: Working with Design Checks](#) (page 256).

Add a minimum radius table

- 1 Open *Align-7C.dwg*, which is located in the [tutorial drawings folder](#) (page 819).

- 2 In the drawing, select the alignment.
- 3 Click Alignment tab ► Modify panel ► Design Criteria Editor  .
When the Design Criteria Editor dialog box opens, it displays the design criteria for the default design criteria file. The  folders on the left side of the dialog box contain tables that specify the units of measure used in the design criteria file, and design criteria tables for alignments and profiles. You can use this dialog box to modify the criteria in the current file, open another file, or create a new file. In the following steps, you will add a criteria table to an existing file, and then save the changes as a new file.
- 4 On the left side of the dialog box, expand the Alignments ► Minimum Radius Tables collection.
The collection contains several minimum radius  tables.
- 5 Right-click Minimum Radius Tables. Click New Minimum Radius Table.
An empty  table appears at the end of the Minimum Radius Tables collection.
- 6 Replace the New Minimum Radius Table text with Local Standards eMax 7%. Press Enter.

Save the design criteria file



- 1 Click  Save As.
- 2 In the Enter A File Name To Save dialog box, navigate to the [My Civil Tutorial Data folder](#) (page 819). In the File Name field, enter Sample_Local_Criteria.xml. Click Save.
If a design criteria file must be shared by multiple users, it must be saved in a location to which all applicable users have access. If you send a drawing that uses a custom design criteria file to a user that does not have access to the shared location, then you also must send the design criteria file.

TIP When the Use Design Criteria File option is selected during alignment creation, the first design criteria found in the [Data\Corridor Design Standards\\[units\] folder](#) (page 819) is applied to an alignment by default. To ensure that a custom design criteria file is selected by default, make sure that its name places it first in the directory.

Add criteria to a table

- 1 In the Design Criteria File Editor dialog box, on the left-hand side, ensure that the Local Standards eMax 7% table is selected.
- 2 On the right-hand side of the dialog box, select the first row in the table. Click the Speed cell. Select 50 from the list.
- 3 Click the Radius cell. Enter 54. Press Enter.
- 4 Repeat steps 2 and 3 to add the following values to the table:

Speed	Radius
70	125
90	235
110	387
130	586

TIP To add a row between two existing rows, click  . To remove a row, click  .

- 5 In the Comments field, enter Minimum radii for 7% superelevation at various design speeds.
Further exploration: Expand the other collections on the left-hand side of the dialog box. Right-click the various folders and tables and examine the options that are available.
- 6 Click Save And Close. When you are notified that the file has unsaved changes, click Save Changes And Exit.
Further exploration: Use the Alignment Properties dialog box to apply the new Sample_Local_Criteria.xml design criteria file and Local Standards eMax 7% table to the alignment in *Align-4b.dwg*.

To continue to the next tutorial, go to [Applying Superelevation to an Alignment](#) (page 262).

Tutorial: Applying Superelevation to an Alignment

In this tutorial, you will calculate superelevation for alignment curves, create a superelevation view to display the superelevation data, and edit the superelevation data both graphically and in a tabular format.

The superelevation feature enables you to apply your local roadway design standards to automatically calculate roadway cross slopes around curves.

BEST PRACTICE Superelevation should be calculated before the corridor model is built along the alignment.

For more information, see *Understanding Superelevation*.

Exercise 1: Calculating Superelevation for an Alignment

In this exercise, you will calculate superelevation for all the curves in an alignment.

For more information, see *Calculating Superelevation Data Using the Wizard*.

To calculate superelevation for a curve

- 1 Open *Align-Superelevation-1.dwg*, which is located in the [tutorial drawings folder](#) (page 819).
- 2 Select the alignment.
- 3 Click Alignment tab ► Modify panel ► Superelevation drop-down ► Calculate/Edit Superelevation  .
A dialog box indicates that the alignment does not contain superelevation data.
- 4 Click Calculate Superelevation Now.
In the Create Superelevation dialog box, the Roadway Type page contains options for how to apply superelevation to various types of roadways. Conceptual graphics illustrate the point about which each lane will pivot.
- 5 Select Undivided Crowned, Pivot Center.

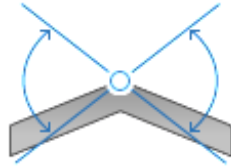

6 Click Next.

The Lanes page contains specifications for the number, width, and slope of each lane.

7 Specify the following parameters:

- Symmetric Roadway: Selected
This specifies that the same parameters are used for both sides.
- Number of Lanes Right: 1
- Normal Lane Width: 6.000m
- Normal Lane Slope: -2.00%

8 Click Next.

The Shoulder Control page contains specifications for how the roadway shoulders behave when the lanes are superelevated.

9 Specify the following parameters:

- Calculate: Selected
- Shoulder Slope Treatment: Breakover Removal
- Normal Shoulder Width: 5.000m
- Normal Shoulder Slope: -5.000%

NOTE The Inside Median Shoulder options are disabled because you selected an undivided roadway type on the Roadway Type page.

10 Click Next.

The Attainment page enables you to specify the superelevation standards to apply. You apply standards by selecting them from a series of lists. The content of the lists reflects the content of the currently selected design criteria file, which you can customize to suit your local standards. For more information, see the [Modifying a Design Criteria File](#) (page 259) tutorial exercise.

- 11 Specify the following parameters:
 - Design Criteria File: `_Autodesk Civil 3D Metric Roadway Design Standards.xml`, which is located in the [Data folder](#) (page 819) in `Corridor Design Standards/Metric`
This is the same design criteria file that the criteria-based design feature uses to validate the alignment and profile geometry.
 - Superelevation Rate Table: AASHTO 2001 eMax 6%
 - Transition Length Table: 2 Lane
 - Attainment Method: AASHTO 2001 Crowned Roadway
 - % Transition Into Tangent: 70.00%
 - % Transition Into Spiral: 100.00%
 - Curve Smoothing: Cleared
 - Automatically Resolve Overlap: Cleared

- 12 Click Finish.

The superelevation values are calculated for each curve, and the Superelevation Tabular Editor vista is displayed. In the drawing, the station value and cross slope at each critical superelevation station is indicated by symbols and green labels. The symbols and labels were specified as part of the alignment label set. They were not displayed before because there was no superelevation data on the alignment.

You will learn how to edit superelevation data in the Superelevation Tabular Editor in [Exercise 4: Adding and Modifying Superelevation Stations](#) (page 269).

- 13 Click  to close the Superelevation Tabular Editor.

To continue this tutorial, go to [Exercise 2: Calculating Superelevation for an Individual Curve](#) (page 264).

Exercise 2: Calculating Superelevation for an Individual Curve

In this exercise, you will calculate superelevation for a single curve in an alignment that already has superelevation data calculated for other curves.

In the drawing that is used with this exercise, the alignment has a fourth curve, for which superelevation has been calculated. You will make a change to the alignment that will cause the superelevation data of the fourth curve to be out of date, and then you will recalculate the superelevation data for that curve.

For more information, see *Calculating Superelevation Data Using the Wizard*.

This exercise continues from [Exercise 1: Calculating Superelevation for an Alignment](#) (page 262).

Change the design speed

- 1 Open *Align-Superelevation-2.dwg*, which is located in the [tutorial drawings folder](#) (page 819).
- 2 Select the alignment.
- 3 Click Alignment tab ► Modify panel ► Superelevation drop-down ► Calculate/Edit Superelevation .

The Create Superelevation wizard was not displayed because superelevation has already been calculated for the first three curves of this alignment. The Superelevation Curve Manager window is displayed. This window enables you to view and edit superelevation parameters on a curve-by-curve basis. By default, the window displays superelevation parameters for the first curve in the alignment.

- 4 Under Superelevation Curve, click Next twice.
Notice that the window displays the parameters for the third curve, which is highlighted in the drawing.
- 5 Under Superelevation Curve Details, in the Design Speed row, click .

In the Alignment Properties - Design Speed dialog box, you can change the design speed of the entire alignment, or add a new design speed at a specified station. In this exercise, you will increase the design speed for the end portion of the alignment and leave the existing design speed at the beginning of the alignment.

- 6 In the Alignment Properties - Design Speed dialog box, click .
- A second row is displayed in the Design Speeds table.

7 In the second row, enter the following parameters:

- Start Station: 0+820.00
- Design Speed: 70 km/h

8 Click OK.

In the Superelevation Curve Manager dialog box, the Design Speed value did not change because the station at which you changed the design speed is located after Curve.3.

9 Click Next.

Under Superelevation Curve Details, for Curve.4, the Design Speed value is 70 km/h, which is what you specified in the preceding steps.

At the bottom of the dialog box, the Superelevation status is displayed as *Out of Date*. Applying the new design speed to this curve caused the superelevation data to become out of date. In the following steps, you will recalculate the superelevation data for this curve to accommodate the new design speed.

Calculate superelevation for an individual curve

1 Click Superelevation Wizard.

The Calculate Superelevation dialog box enables you to select which curves to recalculate.

2 Select This Curve Only. Click OK.

The Calculate Superelevation wizard enables you to specify the parameters used for the calculation. The parameters you specify in the wizard apply to only the curves you selected in the Calculate Superelevation dialog box in Step 1. For example, if you specify a different attainment method or criteria file, then those parameters will not match the rest of the curves in the alignment. In this exercise, you will accept most of the default settings.

3 In the Calculate Superelevation wizard, click Attainment.

4 On the Attainment page, for Superelevation Rate Table, select AASHTO 2001 eMax 6%.

5 Under Curve Smoothing, specify the following parameters:

- Apply Curve Smoothing: Selected
- Curve Length: 30

- 6 Click Finish.
On the Superelevation Tabular Editor window, examine the superelevation values for Curve.4.
- 7 On the Superelevation Curve Manager, scroll down to the Superelevation Criteria category. Expand the category.
- 8 Right-click the Normal Shoulder Width row.
The Apply To Entire Alignment option enables you to update the design criteria at a curve, and then quickly apply the change to all curves in the alignment.
- 9 Right-click the Superelevation Criteria row.
When this option is applied at this level, the design criteria of the current curve overwrites all manual design criteria changes that have been made to the alignment.
- 10 Press Esc.

To continue this tutorial, go to [Exercise 3: Creating a Superelevation View](#) (page 267).

Exercise 3: Creating a Superelevation View

In this exercise, you will display superelevation data in a graph, which you can use to graphically edit superelevation data.

For more information, see *Using Superelevation Views*.

This exercise continues from [Exercise 2: Calculating Superelevation for an Individual Curve](#) (page 264).

Create a superelevation view

- 1 Open *Align-Superelevation-3.dwg*, which is located in the [tutorial drawings folder](#) (page 819).
- 2 Select the alignment.
- 3 Click Alignment tab ► Modify panel ► Superelevation drop-down ► Superelevation View .

The Create Superelevation View dialog box enables you to specify the superelevation view properties, including the name and style of the view.

- 4 In the Create Superelevation View dialog box, under Superelevation View Style, click  Edit Current Selection.
- 5 In the Superelevation View Style dialog box, on the Display tab, change the Graph Reference Line Component Type Color to White.
In a superelevation view, the reference line is a horizontal line that indicates the zero lane slope. In the superelevation view properties, you can specify the colors of the lines that represent the slopes of the lanes and shoulders.
The other superelevation view style properties, such as those that affect the grid and labels, are similar to the properties found in profile view and section view styles.
- 6 Click OK.
- 7 In the Create Superelevation View dialog box, under Specify Superelevation Display Options, in the Right Outside Lane row, double-click the Color cell.
- 8 In the Select Color dialog box, under Color, enter red. Click OK.
- 9 Repeat Steps 7 and 8 to change the other lane colors:
 - Left Outside Shoulder: 150
 - Right Outside Shoulder: 11
- 10 Click OK.
- 11 In the drawing, pan to an empty area above the surface. Click to place the superelevation view.

Examine the superelevation view

- 1 Zoom in to examine the superelevation view.
The white line represents a baseline of 0% slope. The red and blue lines represent the slopes of the outside lanes and outside shoulders.
- 2 Pan and zoom to the area of the superelevation view that has Curve.2 labels on the horizontal axes.
As the alignment transitions in to the curve, the red and blue lines illustrate the following transitions:
 - At station 0+286.28, the left shoulder (light red) starts to transition from the normal -5% slope.

- At station 0+304.54, the left lane (dark red) starts to transition from the normal -2% slope.

NOTE For the remainder of the curve, the dark red line is not visible because it is obstructed by the light red line.

- At station 0+316.71, the left lane and shoulder are at 0% slope.
- At station 0+328.88, the right lane (dark blue) starts to transition from the normal -2% slope.
- At station 0+344.71, all elements are fully superelevated: the left lane and shoulder are at 5%, the right lane is at -4.60%, and the right shoulder is at -5%.

Starting at station 0+512.66, the lanes begin to transition out of the fully superelevated state.

- 3 Pan to the area of the superelevation view that has Curve.4 labels on the horizontal axes.

Notice that there is a curve where each line transitions in or out of a superelevated state. Curves are present on this superelevation curve, but not the others, because you selected the curve smoothing option during [Exercise 2: Calculating Superelevation for an Individual Curve](#) (page 264). Later in this exercise, you will learn how to apply curve smoothing to an existing superelevation curve.

To continue this tutorial, go to [Exercise 4: Adding and Modifying Superelevation Stations](#) (page 269).

Exercise 4: Adding and Modifying Superelevation Stations

In this exercise, you will resolve overlap between two superelevated curves by adding and removing critical stations, and then editing existing superelevation data.

For more information, see *Editing Superelevation Data in the Tabular Editor*.

This exercise continues from [Exercise 3: Creating a Superelevation View](#) (page 267).

Examine the superelevation parameters



- 1 Open *Align-Superelevation-4.dwg*, which is located in the [tutorial drawings folder](#) (page 819).
- 2 In the top viewport, zoom in to the middle of the superelevation view.

Near station 0+558.66, the  indicates that the two curves overlap. At the bottom of the superelevation view, the light blue and red lines, which represent the left and right shoulders, cross over each other.

- 3 In the superelevation view, select one of the lines.
- 4 Right-click. Click Open Tabular Editor.
- 5 In the Superelevation Tabular Editor, scroll down to Curve.3.

In the Overlap column, two rows display . This icon indicates that the superelevation stations of two or more critical stations overlap. In this case, station value for the last critical station of Curve.2 is greater than the station value for the first critical station of Curve.3.

- 6 Under Curve.3, under Transition In Region, select the End Normal Shoulder row.
The curve is highlighted in the bottom viewport, and the critical station is marked with a blue tick.

- 7 In the Overlap column, click .
The Superelevation - Overlap Detected dialog box presents two options:
 - Automatically Resolve Overlap—This option removes the overlapping critical stations of the affected curves.
 - Ignore Overlap—This option enables you to return to the Superelevation Tabular Editor to manually modify the data. The  icons are not cleared.

- 8 In the Superelevation - Overlap Detected dialog box, click Ignore Overlap.

Edit superelevation stations

- 1 In the Superelevation Tabular Editor, under Curve.2 ► Transition Out Region, select the Begin Normal Shoulder row.

- 2 Change the Start Station value to 0+560.00.

Remove a superelevation critical station

- 1 In the Superelevation Tabular Editor, under Curve.3 ► Transition In Region, select the End Normal Shoulder row.
- 2 Click  .
The End Normal Shoulder superelevation critical station is removed.

Add a superelevation critical station

- 1 In the Superelevation Tabular Editor, select the Curve.3 row.
- 2 Click  .
The Superelevation Tabular Editor is hidden, and you are prompted to specify a station along the alignment.
- 3 On the command line, enter 568. Press Enter.
A new manual station, which starts at station 0+568.00, is displayed in the Superelevation Tabular Editor.
- 4 Right-click the Manual Station. Click Assign Critical Station ► End Normal Shoulder.
- 5 In the End Normal Shoulder row, enter the following values:

NOTE The remaining columns are interpreted from these values.

- Left Outside Shoulder: -5.00%
- Left Inside Lane: -2.00%
- Right Inside Lane: -2.00%
- Right Outside Shoulder: -5.00%

NOTE To import existing superelevation data from a CSV file, click  .

Notice that the  icons are no longer displayed in the Overlap column.

- 6 Click  to close the Superelevation Tabular Editor.

To continue this tutorial, go to [Exercise 5: Editing Superelevation Parameters Graphically](#) (page 272).

Exercise 5: Editing Superelevation Parameters Graphically

In this exercise, you will use grips in a superelevation view to modify the superelevation cross slopes and critical station values.

For more information, see *Creating and Editing Superelevation Views*.

This exercise continues from [Exercise 4: Adding and Modifying Superelevation Stations](#) (page 269).

Examine the grips

- 1 Open *Align-Superelevation-5.dwg*, which is located in the [tutorial drawings folder](#) (page 819).
- 2 In the Curve.4 portion of the superelevation view, click any of the red or blue lines.
A series of grips appears at each of the superelevation critical stations along each line, as well as on the superelevation view. You will learn the purpose of the grips later in this exercise.
- 3 Press Esc.

Move a critical station graphically

- 1 Near station 0+900.00, Ctrl+click the green Shoulder text.
Only the grips of the selected superelevation region are displayed.
- 2 Hover the cursor over the  grip at station 0+909.34.
The cursor snaps to the grip, and a menu of options is displayed. You can use this grip to either change the station value, or add or remove a critical station.
- 3 Select Move End Normal Shoulder.
- 4 Enter 900.
The transition in region is updated.

NOTE The new station value is also shown in the Superelevation Tabular Editor and Superelevation Curve Manager.

- 5 Press Esc.

Remove or apply curve smoothing



- 1 Pan to the transition out region of Curve.4.
- 2 Near station 1+147.69, Ctrl+click the light red curve.

- 3 Hover the cursor over the  grip at station 1+147.69.
The cursor snaps to the grip, and a menu of options is displayed. You can use this grip to change the cross slope at this critical station, remove the grade break, or remove curve smoothing.
- 4 Select Remove Curve Smoothing.
The curve is removed from the grade break.



NOTE You may use the same process to add curve smoothing to a grade break.

- 5 Press Esc.

Change the cross slope at a superelevation critical station

- 1 At station 1+147.69, hover the cursor over the  grade grip.
When a grade grip is cyan, a grade break exists at the current location. Like other cyan grips in a superelevation view, a menu of options is displayed.
- 2 At station 1+115.55, hover the cursor over the  grip.
When a grade grip is gray, the current location has a consistent grade. Because no grade break is present, the only option is to change the cross slope.
- 3 Click the grip to make it active.
- 4 Enter 1.5.
Notice that the grip color is now cyan. This happened because you created a grade break at the current location.

Change the cross slope between superelevation curves

- 1 Pan to the left until you see the  grip near station 1+000.00.
- 2 Hover the cursor over the  grip.
The cursor snaps to the grip, and a menu of options is displayed. You can use this grip to change the cross slope of either one or both of the shoulders or lanes between the previous and next superelevation critical stations. This grip is available in sections where lanes or shoulders are fully superelevated, as well as on tangents that are between curves.
- 3 Select Move Both Left and Right.
- 4 Enter 4.
The cross slopes of both the left and right shoulders are updated.

Profiles Tutorials

9

These tutorials will get you started viewing and designing the elevation profile of land surfaces along a horizontal alignment.

NOTE All drawings used in these tutorials are available in the [tutorial drawings folder](#) (page 819). If you want to save your work from these tutorials, save the drawings to the [My Civil Tutorial Data folder](#) (page 819) so that you do not overwrite the original drawings.

For more information, see the AutoCAD Civil 3D Help topic *Understanding the Profile Object*.

Tutorial: Designing Simple Profiles

In this tutorial, you will create simple existing ground and layout profiles for an alignment.

An *existing ground* profile is extracted from a surface and shows the changes in elevation along a horizontal alignment. A *layout* profile is a designed object that shows the proposed grade and elevations to be constructed. Profiles are displayed on an annotated grid called a *profile view*.

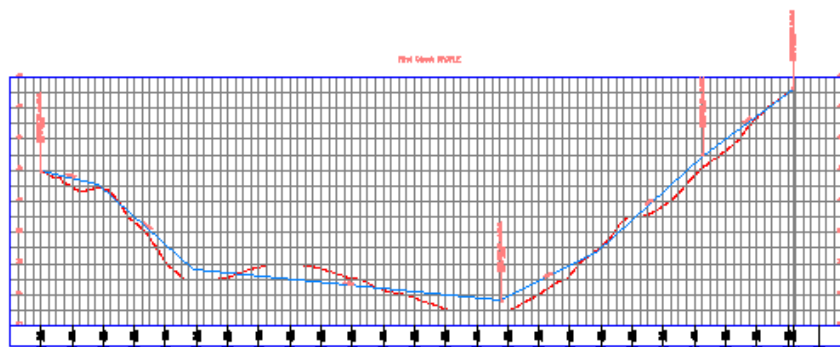

For more information, see the AutoCAD Civil 3D Help topic *Understanding the Profile Object*.

Display an existing ground profile in a profile view

- 1 Open drawing *Profile-1.dwg*, which is located in the [tutorial drawings folder](#) (page 819).

This drawing contains an existing ground surface, an alignment that represents a road centerline, and a polyline that represents the centerline of an intersecting road. You will use the rectangle in the northeast corner of the site as a guide to create a profile view.

- 2 Click Home tab ► Create Design panel ► Profile drop-down ► Create Surface Profile  .
- 3 In the Create Profile From Surface dialog box, click Add.

NOTE For this exercise, the First Street alignment and the EG surface are the only available selections, and are selected by default.

- 4 Click Draw in Profile View.
- 5 In the Create Profile View wizard, click Create Profile View.
- 6 In the drawing, click the lower left corner of the rectangular placeholder.

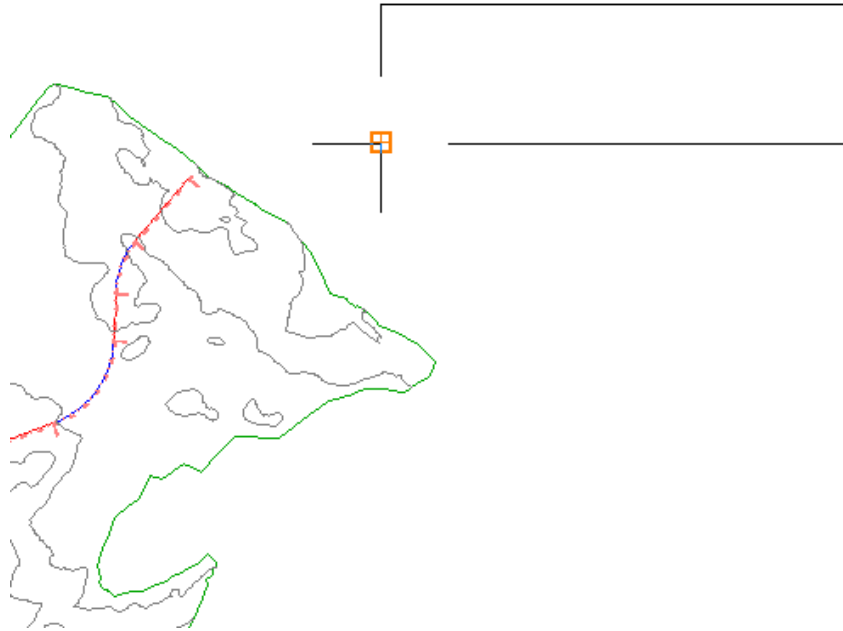

The First Street Profile view is displayed, containing the dashed profile that represents the existing ground (EG) surface. The left and right sides annotate elevations. The bottom annotates the stations.

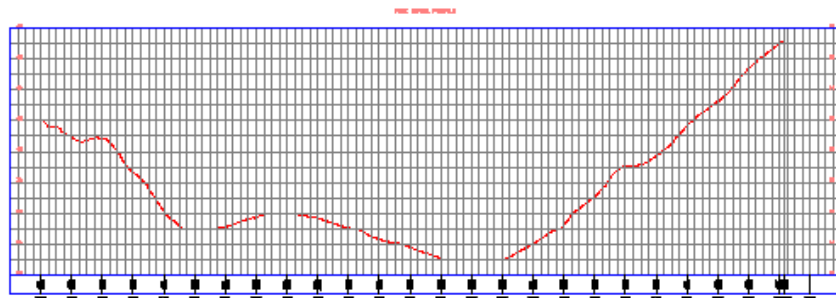

Create a layout profile

- 1 Click Home tab ► Layers panel ► Layer drop-down. Next to the `_PROF-ROAD-FGCL-PL` layer, click .

You will use the circles in the profile view as a guide to draw a layout profile.

2 Click Home tab ► Create Design panel ► Profile drop-down ► Profile Creation Tools  .

3 Select the profile view that you created.

4 In the Create Profile - Draw New dialog box, specify the following parameters:

■ Name: Finished Grade Centerline - First Street

■ Profile Style: Design Profile

■ Profile Label Set: Complete Label Set

Click OK.

The Profile Layout Tools toolbar is displayed. This toolbar enables you to lay out a finished grade profile, using either *points of vertical intersection* (PVI) or constraint-based tangent and curve entities. For this exercise, you will create PVI at specified points. Tangents will be created between the PVI, and curves will be created at each PVI.

5 On the Profile Layout Tools toolbar, in the Draw Tangents list  , select Draw Tangents With Curves.

The command line prompts you to specify a start point.

Before selecting a start point, verify that Object Snap (OSNAP) is on and Endpoint and Center modes are selected.

6 On the status bar, right-click Object Snap  . Click Settings.

7 In the Drafting Settings dialog box, on the Object Snap tab, click Clear All, then select **Endpoint** and **Center**. Click OK.

8 Moving from left to right, click the circle center points to place PVI.

9 Press Enter to complete the layout profile.

The blue Finished Grade Centerline profile and its labels are displayed in the profile view.

10 Close the Profile Layout Tools toolbar.

- 11 Click Home tab ► Layers panel ► Layer drop-down. Next to the **PROF-ROAD-FGCL-PL** layer, click . Click in the drawing to exit the Layer Control list.

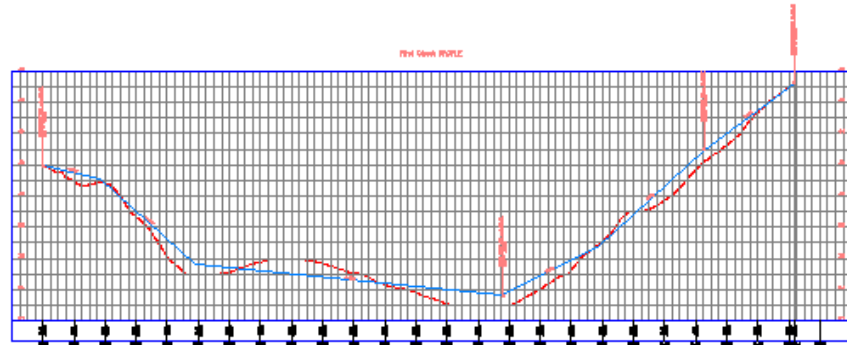

To continue to the next tutorial, go to [Using Surface Profiles](#) (page 279).

Tutorial: Using Surface Profiles

This tutorial demonstrates how to create surface profiles and display them in a profile view.

A surface profile is extracted from a surface, and is often called an *existing ground* profile. It is displayed on a graph called a *profile view*. Each profile view is associated with a single horizontal alignment, but it can display multiple surfaces and offset profiles from that alignment. An *offset profile* displays surface elevations at a specified distance horizontally offset from the alignment. When you create a profile along the centerline of a horizontal alignment, AutoCAD Civil 3D can create one or more offset profiles automatically.

Surface profiles can be either static or dynamic. A *static* profile shows the elevations at the time it was created, but does not react to later changes in the alignment or surface. A *dynamic* profile automatically changes if the elevation changes along the horizontal alignment, so it remains current.

For more information, see the AutoCAD Civil 3D Help topic *Creating Profiles*.

Exercise 1: Creating and Displaying Surface Profiles with Offsets

In this exercise, you will create a surface profile from an existing surface.

After creating the profile and several offsets, you will create a profile view to display the profiles.

For more information, see the AutoCAD Civil 3D Help topic *Creating Surface Profiles*.

Create centerline and offset surface profiles

- 1 Open *Profile-2A.dwg*, which is located in the [tutorial drawings folder](#) (page 819).

The drawing contains an existing ground surface and two horizontal alignments. Examine the alignments. The red one with curves is named Ridge Road, and represents a proposed road centerline. The other is named Power Line, and represents a proposed power line offset about 25 feet from the road.

- 2 Click Home tab ► Create Design panel ► Profile drop-down ►  Create Surface Profile.
- 3 In the Create Profile From Surface dialog box, under Alignment, select Ridge Road.
- 4 Click Add.
- 5 Select the Sample Offsets check box. In the field next to the check box, enter 25,-25 (including comma).

This field enables you to specify that profiles be created on either side of the centerline. The left offset (-25) will mark the approximate location of the power line. If you wanted more offsets, you could enter a series of them here. Use positive numbers for right offsets and negative numbers for left offsets, with values separated by commas.
- 6 Click Add.
- 7 In the Profile List, in the Description column, enter the following descriptions:
 - EG - Surface: Centerline
 - EG - Surface - 25.000: Right Offset
 - EG - Surface - -25.000: Left Offset

- 8 In the Profile List, in the Update Mode column, for the left offset, change the value to Static.

This option specifies that the left offset reflects the surface elevations at the time of its creation. It will not update to reflect future changes in the surface.

- 9 Click OK.

A message that indicates profiles have been created is displayed in the Event Viewer.

Display the surface profiles in a profile view

- 1 Click Home tab ► Profile & Section Views panel ► Profile View drop-down ►  Create Profile View.

The Create Profile View wizard is displayed, where you can configure the display of the profile. The wizard contains the many controls for displaying profiles in a profile view. You can use either the Back and Next buttons at the bottom or the links along the left side to navigate through the pages. You can click Create Profile View at any time to accept the settings and create the profile view in the drawing.

- 2 In the Create Profile View wizard, on the General page, under Select Alignment, select Ridge Road.

- 3 Click Profile Display Options.

The table on the Profile Display Options page shows the existing profiles for Ridge Road. By default, they are all checked in the Draw column, indicating that they will appear in the profile view.

- 4 In the Specify Profile Draw Options table, in the Style column, double-click the cell for the Left Offset.

- 5 In the Pick Profile Style dialog box, change the style to Existing Ground. Click OK.

- 6 In the Specify Profile Draw Options table, in the Labels column, double-click the cell for the Left Offset.

- 7 In the Pick Profile Label Set dialog box, change the style to <None>. Click OK.

You will not create labels for the existing ground profiles. You will specify a label set when you create a layout profile in the [Using Layout Profiles tutorial](#) (page 287).

- 8 Repeat Steps 6 and 7 for the other two profiles.
- 9 Click Create Profile View.
- 10 In the drawing, pan and zoom to a blank area at the lower right of the surface. Click at a suitable location for the lower left corner of the profile view grid.

The profile view is drawn, with a grid, axes, title, and two data bands along the X axis, one above the grid and another below it.

Because of its style, the left offset line is red.

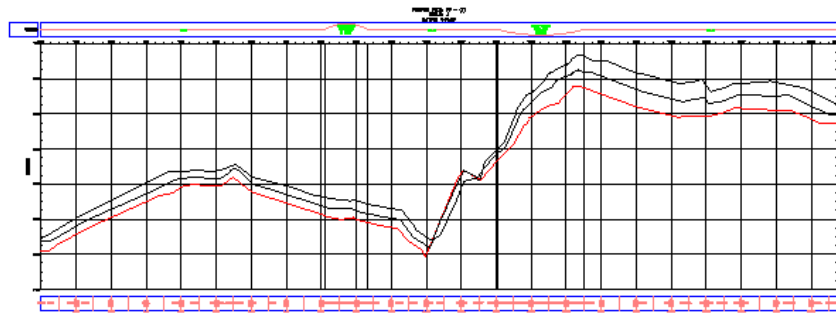

NOTE If you want to move a profile view within a drawing, click anywhere on the grid to select it. A blue grip appears near the lower left corner. Click the grip and drag the profile view to a new location.

To continue this tutorial, go to [Exercise 2: Changing the Profile Style](#) (page 282).

Exercise 2: Changing the Profile Style

In this exercise, you will change a profile style in two different ways.

First, you will change a profile style globally, which changes the profile's appearance in all profile views. Then, you will learn how to override a profile style in a single profile view. Finally, you will hide the offset profiles.

For more information, see the AutoCAD Civil 3D Help topic *Styles and Display of Profile and Profile Views*.

This exercise continues from [Exercise 1: Creating and Displaying Surface Profiles with Offsets](#) (page 280).

Create a profile view

- 1 Open *Profile-2B.dwg*, which is located in the [tutorial drawings folder](#) (page 819).
- 2 Click Home tab ► Profile & Section Views panel ► Profile View
Drop-down ►  Create Profile View.
- 3 In the Create Profile View wizard, on the General page, under Select Alignment, click Ridge Road.
- 4 Click Profile Display Options.
- 5 Under Specify Profile Draw Options, in the Style column, double-click the cell for the Left Offset profile.
- 6 In the Pick Profile Style dialog box, select Standard. Click OK.
- 7 In the Name column, select the first row. Hold down the Shift key, and then select the last row.
- 8 In the Labels column, double-click one of the cells.
- 9 In the Pick Profile Label Set dialog box, select <None>. Click OK.
- 10 In the Create Profile View wizard, click Create Profile View.
- 11 Pan to a location above the top of the first profile view, then click in the drawing.
The new profile view, PV - (2), is drawn. The left offset profile is the same color as the other two profiles.
- 12 Pan to the lower profile view, PV - (1).
Notice that its left offset line has also changed. The left offset profile changed because you changed the style of the profile, which affects every instance of the profile in every profile view in the drawing.

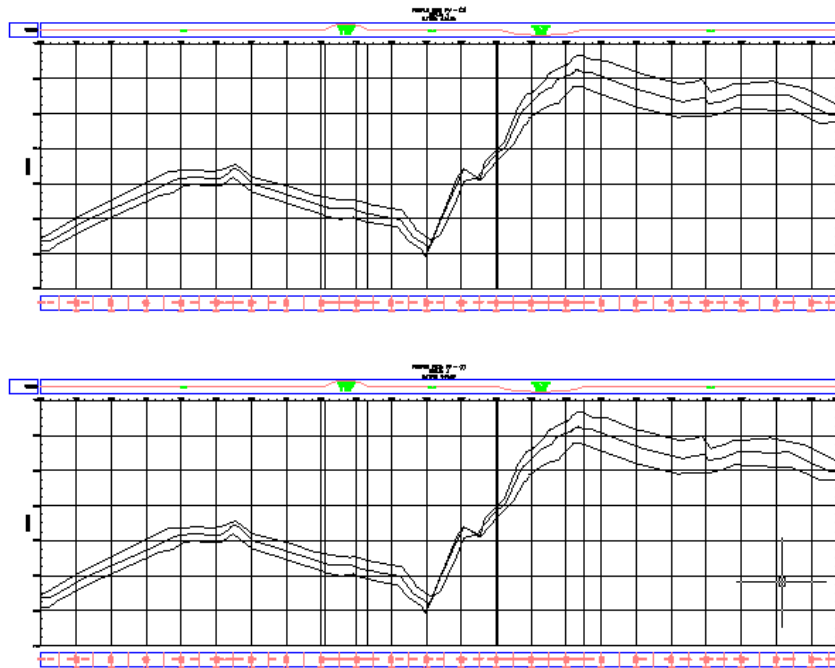

Change a profile style

- 1 Select the PV - (1) profile view grid. Right-click. Click Profile View Properties.
- 2 Click the Profiles tab.
On this tab, you can change properties of a profile line after it has been drawn in a profile view.
- 3 On the Profiles tab, scroll until you can see the Style and Override Style columns.
- 4 In the Override Style column for the Left Offset, double-click the check box.
- 5 In the Pick Profile Style dialog box, select Existing Ground. Click OK.
- 6 In the Profile View Properties dialog box, click Apply.
The Left Offset profile changes to red (reflecting the Existing Ground style) in profile view PV - (1), but not in PV - (2). The left offset profiles are different because you overrode the profile style for the particular

profile view, but did not change the profile style. You can use a style override to preserve the profile style within a profile view, protecting it from later style changes.

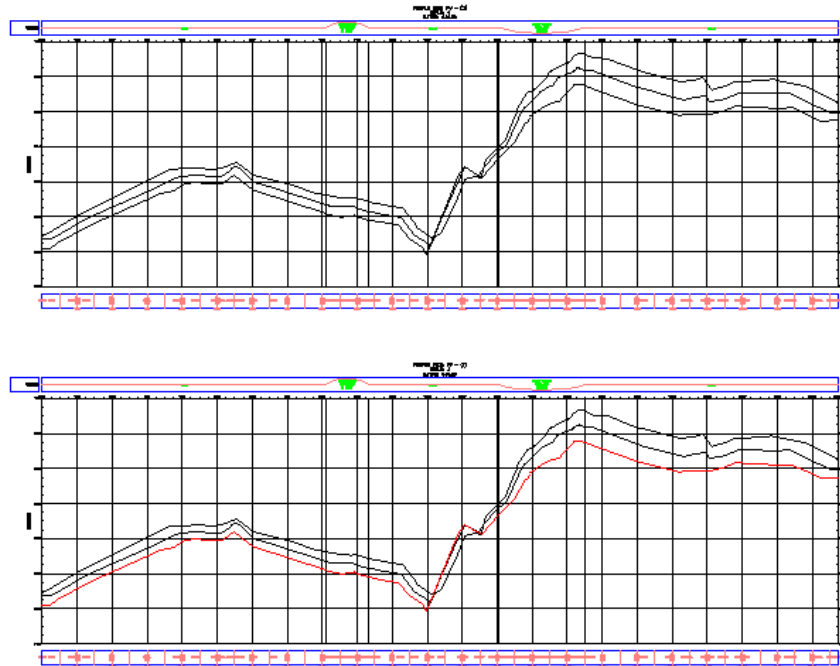

Further exploration: In the Profile View Properties dialog box, clear the Override Style check box for the left offset. Click the Style column for this offset, change it to Standard, then click Apply. This changes the style for the profile and affects both profile views in the drawing.

NOTE The left offset line is an approximate and static profile of the terrain along the power line. Optionally, if you wanted to see the actual profile, you could create a profile and profile view based on the Power Line alignment.

To continue this tutorial, go to [Exercise 3: Reviewing Surface Profile Characteristics](#) (page 285).

Exercise 3: Reviewing Surface Profile Characteristics

In this exercise, you will examine some of the information displayed in the profile and the profile view.

For more information, see the AutoCAD Civil 3D Help topic *Editing Profile Curve and Tangent Parameter Values*.

This exercise continues from [Exercise 2: Changing the Profile Style](#) (page 282).

Examine the profile view characteristics

- 1 Open *Profile-2C.dwg*, which is located in the [tutorial drawings folder](#) (page 819).
- 2 Zoom in to the lower profile view PV - (1) so that you can clearly see the three profile lines.
- 3 Select the highest profile line (the right offset profile), being careful not to select the profile view grid. Right-click. Click Edit Profile Geometry. The Profile Layout Tools toolbar is displayed. Notice that no editing grips are displayed along the profile, and most controls in the Profile Layout Tools toolbar are shaded and unavailable. This profile is dynamic. It is linked to the surface elevations, and no part of the line can be edited.

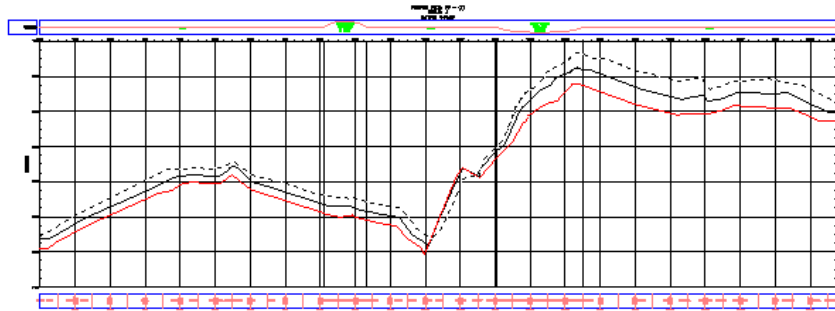

- 4 In the Profile Layout Tools toolbar, click  . The Profile Entities vista is displayed in the Panorama window. This table displays useful grade data for the entire profile. Again, values are shaded and unavailable so you cannot edit them. Editing these values would break the integrity of the link between the profile and the surface.
- 5 Press Esc to deselect the right offset profile.
- 6 Click the red (left offset) profile line. Notice that editing grips appear along this profile. If you zoom out, you can see that the same profile is also selected in the other profile view. If you grip edit the profile in one profile view, the same changes apply to the other copy of the profile.

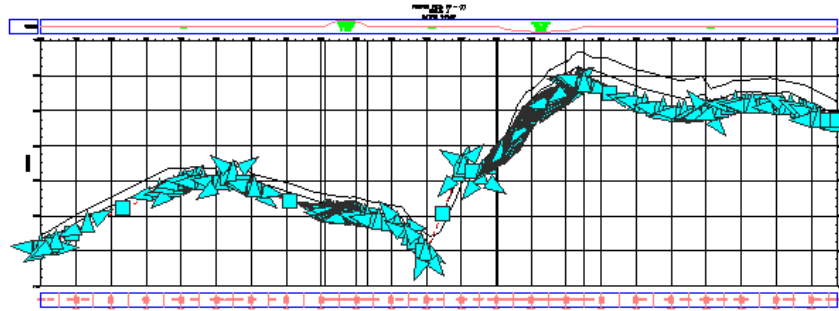

Because this line is a static profile, and detached from the surface, you can edit it in various ways, including copying and moving it. You would not edit this line if you wanted to preserve it as a snapshot of the surface at a particular time.

Notice that the Profile Entities table now displays the design data for the left offset profile, with values you can edit. When you selected the left offset profile, it became the active profile for the editing tools.

- 7 Close the Profile Layout Tools toolbar.

The Profile Layout Tools toolbar and Profile Entities vista both close, and the left offset profile line is deselected in the drawing.

To continue to the next tutorial, go to [Using Layout Profiles](#) (page 287).

Tutorial: Using Layout Profiles

This tutorial demonstrates how to create and edit layout profiles, which are often called design profiles or finished grade profiles.

A layout profile represents a proposal for a road or other designed surface. This type of profile is always drawn on the grid of a profile view, which usually displays the surface profile along the same horizontal alignment.

A layout profile includes the following elements:

- Straight line tangents with specified grade or slope.
- Points of vertical intersection (PVI) where tangents meet.
- Vertical curves that are usually parabolic in shape. Vertical curves can also be circular or asymmetrical parabolic.

Vertical curves can be one of two basic types: crest curves or sag curves.

- A *crest* curve exists at a hilltop, or wherever the incoming tangent has a higher grade than the outgoing tangent. There are three types of crest curves: a positive to negative grade transition, positive to positive, and negative to negative. The point of vertical intersection (PVI) of a crest curve is above the curve.
- A *sag* curve exists at the bottom of a valley, or wherever the incoming tangent has a lower grade than the outgoing tangent. There are three types of sag curves: a negative to positive grade transition, negative to negative, and positive to positive. The PVI of a sag curve is below the curve.

The vertical curves on a layout profile can be designed in relation to engineering speed tables for safe vehicular travel at a particular maximum speed. Other tables can be used to design vertical curves so that the distance illuminated by the headlights of a vehicle at night is always greater than the stopping distance at the maximum design speed.

For more information, see the AutoCAD Civil 3D Help topics *Creating Layout Profiles* and *Vertical Curve Design*.

Exercise 1: Creating a Layout Profile

In this exercise, you will create the layout profile. Typically, this profile is used to show the elevations along a proposed road surface or a finished grade.

The layout profile is similar to a horizontal alignment, in that it is constructed of straight tangents with optional curves placed where the tangents intersect. These tangents and curves on a layout profile are located in the vertical plane and the intersection points are called points of vertical intersection (PVI).

For more information, see the AutoCAD Civil 3D Help topic *Creating Layout Profiles*.

This exercise continues from the [Using Surface Profiles](#) (page 279) tutorial.

Hide the offset profiles

- 1 Open *Profile-2C.dwg*, which is located in the [tutorial drawings folder](#) (page 819).
- 2 Click the bottom grid to select profile view PV-1. Right-click. Click Profile View Properties.

- 3 In the Profile View Properties dialog box, on the Profiles tab, clear the Draw check boxes for the right offset and left offset profiles.

The Profiles tab displays all existing profiles for a given horizontal alignment, both surface profiles and layout profiles. You can use the Draw check boxes to specify which profiles to display in the profile view.



Further exploration: You can permanently delete a profile by selecting it in the drawing (or in Toolspace) and pressing the Delete key. If you delete a profile, it is removed from all profile views, the list of profiles in the Profile View Properties dialog box, and Toolspace. To restore a deleted surface profile, create a new one. The new profile is displayed in any applicable profile views, and can be edited in the Profile View Properties dialog box.

To continue with this exercise, ensure that the centerline profile is visible in profile view PV- (1).

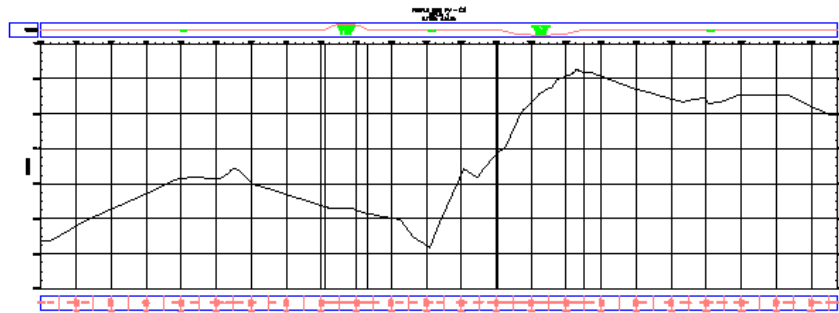
- 4 Click OK.



Specify the profile creation settings

- 1 **NOTE** Turn off Object Snap (OSNAP). For more information, see *Object Snapping*.
- 2 Click Home tab ► Create Design panel ► Profile drop-down ►  Profile Creation Tools.
- 3 Click the bottom grid to select profile view PV-1.
- 4 In the Create Profile – Draw New dialog box, change the Profile Style to Finished Ground.
- 5 In the Profile Label Set list, select Standard. Click .

- 6 In the Profile Label Set dialog box, on the Labels tab, specify the following parameters:
 - Type: Horizontal Geometry Points
 - Profile Horizontal Geometry Point: Station & Type
- 7 Click **Add**.
- 8 In the Geometry Points dialog box, examine the geometry points that can be labeled. You can specify any combination of points that you want to label. Click OK.

NOTE For more details about geometry point labels, see the [Adding Labels in Groups tutorial exercise](#) (page 745).

- 9 In the Profile Label Set dialog box, click OK.
- 10 Click the Design Criteria tab.

The options on this tab are used only if you want to ensure that the profile design meets specified design criteria. You will not apply design criteria to the profile in this exercise. You will learn how to use the design criteria feature in the [Designing a Profile that Refers to Local Standards tutorial](#) (page 297).
- 11 Click OK to accept the settings.

Draw the layout profile

- 1 In the Profile Layout Tools toolbar, click the arrow on the right side of  and click Curve Settings.
- 2 On the Vertical Curve Settings dialog box, specify the following parameters:
 - Curve Type: Parabolic
 - Crest Curve Length: 100
 - Sag Curve Length: 100

Notice that you can select one of three curve types and specify parameters for each type.
- 3 Click OK.

- 4 In the Profile Layout Tools toolbar, ensure that Draw Tangents With Curves  is selected.

You are now ready to draw the layout profile by clicking in the drawing at the proposed locations of PVI. At each PVI, the application inserts a curve. To be realistic, your line should follow the general profile of the surface centerline. However, it can cut across steep hills and valleys to outline a smoother road surface.

- 5 In the profile view, click the left side, near the centerline surface profile, to start the layout profile.

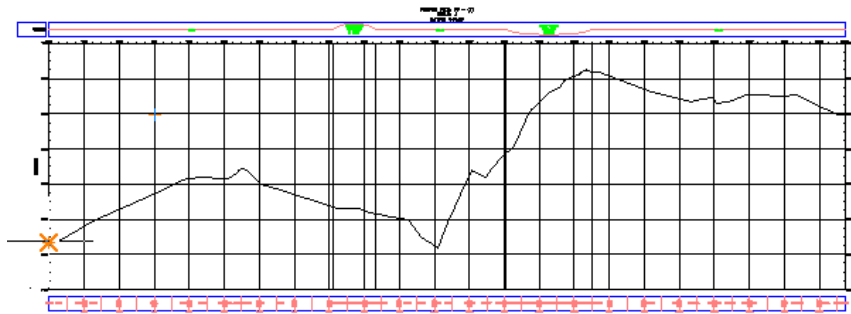

- 6 Extend the line to the right and click at another location near the centerline surface profile. Continue in this manner.

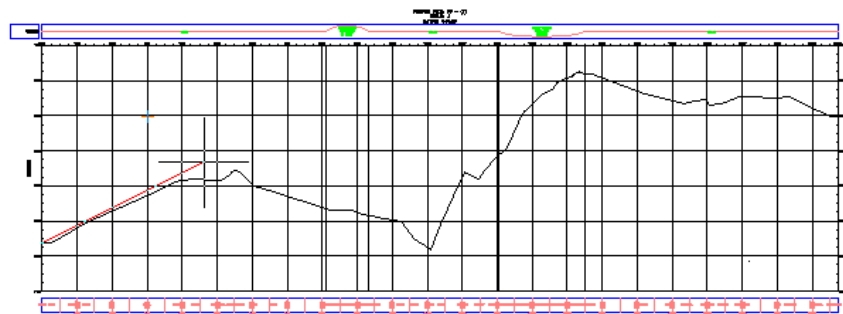

- 7 At the last point, right-click to end the profile. The layout profile is now drawn and labeled.

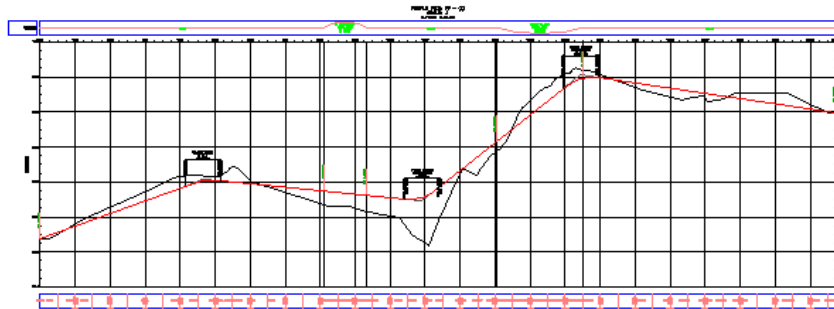

- 8 Zoom and pan along the layout profile to examine the labels.

To continue this tutorial, go to [Exercise 2: Editing a Layout Profile](#) (page 292).



Exercise 2: Editing a Layout Profile

In this exercise, you will modify the layout profile by using grips and entering specific attribute values.

For more information, see the AutoCAD Civil 3D Help topic *Editing Layout Profiles*.

This exercise continues from [Exercise 1: Creating a Layout Profile](#) (page 288).

Edit the profile parameters

- 1 Open *Profile-3A.dwg*, which is located in the [tutorial drawings folder](#) (page 819).
- 2 In the bottom profile view, select the red layout profile. Right-click. Click Edit Profile Geometry.
The Profile Layout Tools toolbar is displayed.
- 3 On the Profile Layout Tools toolbar, click  .
This option specifies that you will edit the data for each profile PVI. If you had clicked  , you would edit the data for each profile line and curve sub-entity.
- 4 On the Profile Layout Tools toolbar, click Profile Grid View  .
The Profile Entities vista is displayed in the Panorama window. The first row in the table provides data about the starting point of the layout

profile. Subsequent rows provide data about the PVI. The last row provides data about the end point.

- 5 Examine the Grade In and Grade Out columns with the aim of reducing one or more of the steeper grades in the profile.

Notice that the Grade Out value for one PVI is the same as the Grade In value for the next PVI. The values are the same because they refer to the same tangent.

- 6 In row No. 3, in the Grade Out column, double-click the 8.000% value and then enter 5.000. Press Enter.

The value changes in the Grade In column of row No. 4. The line in the drawing adjusts to the new value.

Further exploration: Experiment with changing K values and Profile Curve Lengths. In each case, the Profile Curve Radius also changes.

This exercise demonstrates that if your design process provides you with guidelines for K values or vertical curve length, you can easily edit profile specifications in the Profile Entities table.

- 7 On the Profile Layout Tools toolbar, click Profile Layout Parameters .

- 8 In the Profile Entities vista, select row 2.

The Profile Layout Parameters dialog box displays the parameters for the first PVI on the profile.

Grip edit the profile

- 1 With a profile curve clearly visible, click the circular grip at the curve midpoint. The grip turns red, which indicates that it can be moved.

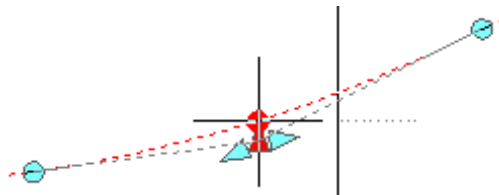

- 2 Move the cursor to a new location closer to or farther from the PVI, then click.

The curve moves to pass through the point you clicked. The length of the curve changes.

Notice that the affected attributes update in the Profile Entities vista and Profile Layout Parameters window.

Further exploration: Click another grip and move it to a new location. Note how other grips react.

- 3 Click the triangular grip at the curve midpoint.

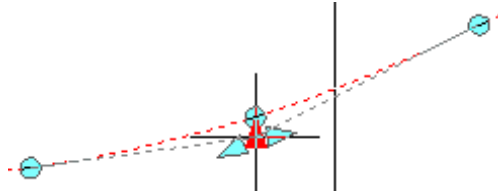

- 4 Move the cursor to a new location closer to or farther from the PVI, then click.
In the Profile Entities vista, notice which entity's PVI Elevation updates.
- 5 Select the row of the entity that you changed.
The entity's attribute values are displayed in the Profile Layout Parameters window.
- 6 Close the Profile Layout Tools toolbar.
The Panorama window (Profile Entities vista) and Profile Layout Parameters dialog box close.

To continue this tutorial, go to [Exercise 3: Copying a Profile and Offsetting it Vertically](#) (page 294).

Exercise 3: Copying a Profile and Offsetting it Vertically

In this exercise, you will copy part of a centerline layout profile. You will use the copy to create a starting line for a ditch profile that is a specified distance below the centerline.

For more information, see the AutoCAD Civil 3D Help topic *Copying a Profile*.

This exercise continues from [Exercise 2: Editing a Layout Profile](#) (page 292).

Copy the layout profile

- 1 Open *Profile-3B.dwg*, which is located in the [tutorial drawings folder](#) (page 819).

- 2 In profile view PV-1, select the red layout profile. Right-click. Click Edit Profile Geometry.
- 3 In the Profile Layout Tools toolbar, click  .Copy Profile
- 4 In the Copy Profile Data dialog box, specify the following parameters:
To use more advanced features of the product, you will make the profile copy shorter than the original.

NOTE The station values recommended in this step have been chosen because in the drawing *Profile-3B.dwg*, they include the two center tangents of the Layout (1) profile. If you are using another drawing with a much different profile, you may have to enter different station values. To be included in the profile copy, a complete tangent must be within the copied range. If part of a tangent extends beyond the range, the whole tangent is excluded from the selection set.

- PVI Range: Station Range
 - Start: 300
 - End: 1700
 - Destination Profile Options: Create New Profile
- 5 Click OK.
The new profile is drawn on top of the old one.
 - 6 In Toolspace, on the Prospector tab, expand the Alignments ► Centerline Alignments ► Ridge Road ► Profiles collection under the alignment.
Your profile copy is displayed with the layout profile icon  and name.
 - 7 Press Esc.

Offset the profile

- 1 In the drawing, click the profile view. Right-click. Click Profile View Properties.
- 2 On the Profiles tab, clear the Draw check box for the original layout profile, Layout (1).
Clearing the check box removes the original profile from the profile view. Later, you can restore this profile to the profile view if you wish.

TIP Instead of removing a profile from the profile view, you can try selecting a profile to move it. However, the process described here is more reliable with overlapping profiles.

- 3 Click OK.

The Profile View Properties dialog box closes and the profile view is redrawn, showing the copy of part of the layout profile.

- 4 Click the layout profile.

The name of the selected profile is displayed in the Profile Layout Tools toolbar. In the next few steps, you will lower the profile copy by 5 feet to represent the elevation of the ditch.

- 5 On the Profile Layout Tools toolbar, click  Raise/Lower PVIs.

- 6 In the Raise/Lower PVI Elevation dialog box, specify the following parameters:

- Elevation Change: -5
- PVI Range: All

- 7 Click OK.

In both profile views, the line moves to its new position.

This profile copy is a full-featured object that can be edited in the same way as the original layout profile.

- 8 Press Esc to deselect the profile.

- 9 In the drawing, click the profile view. Right-click. Click Profile View Properties.

- 10 On the Profiles tab, set the Draw check boxes to the following states:

- Layout (1): Selected
- Layout (1) [Copy]: Cleared

- 11 Click OK.

Clearing the check box removes the copy of the profile from the profile view. Notice that the copy is still displayed in the profile view PV-(2).

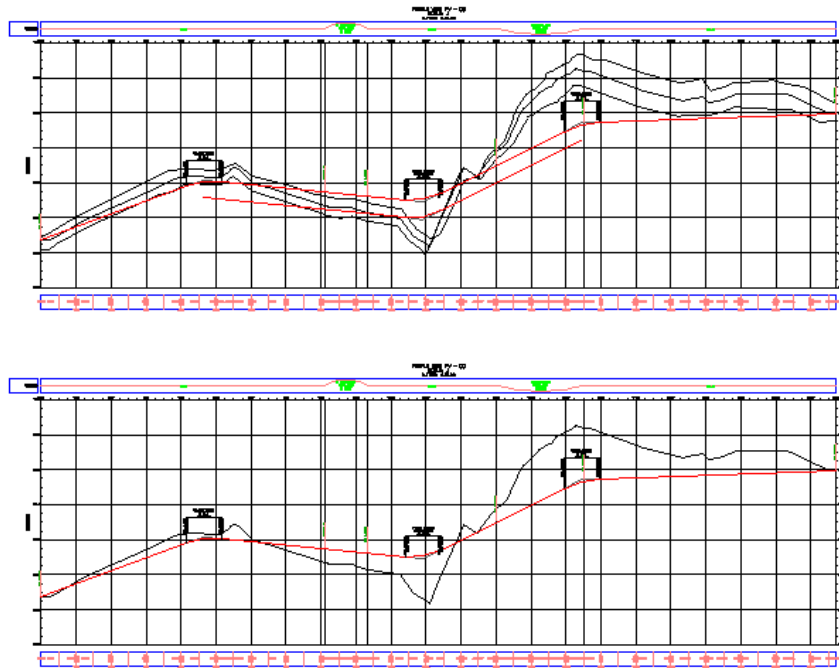

To continue to the next tutorial, go to [Designing a Profile that Refers to Local Standards](#) (page 297).

Tutorial: Designing a Profile that Refers to Local Standards

This tutorial demonstrates how to validate that your profile design meets criteria specified by a local agency.

To create a profile using design criteria, you use the same basic workflow that you use to create a profile without design criteria. During profile creation, you can select a design criteria file, from which you can specify the minimum K tables to which the profile must comply. If the parent alignment also uses design criteria, the design criteria file that is specified for the alignment is applied to the profile by default. You can specify a different design criteria file for the profile, if desired.

The design criteria file specifies minimum K values at given speeds for stopping, passing, and headlight sight distances. You can create custom design checks

to validate profile design criteria other than minimum K values. To apply a design check to a profile, you must add it to a design check set.

NOTE For detailed exercises on creating design checks and modifying the design criteria file, see the [Designing an Alignment that Refers to Local Standards tutorial](#) (page 248).

For more information, see the AutoCAD Civil 3D Help topic *Criteria-Based Profile Design*.

Exercise 1: Specifying Profile Design Criteria



In this exercise, you will specify minimum standards for a layout profile.

For more information, see the AutoCAD Civil 3D Help topic *Creating Layout Profiles*.

Specify minimum profile design standards

- 1 Open *Profile-4A.dwg*, which is located in the [tutorial drawings folder](#) (page 819).
- 2 Click Home tab ► Create Design panel ► Profile drop-down ►  Profile Creation Tools.
- 3 Click one of the grid lines to select the profile view.
- 4 In the Create Profile – Draw New dialog box, on the General tab, specify the following parameters:
 - Name: Main Road
 - Profile Style: Design Profile
 - Profile Label Set: <none>
- 5 On the Design Criteria tab, select the Use Criteria-Based Design check box.

The Use Design Criteria File, Default Criteria, and Use Design Check Set options are now available. The design criteria file that was selected by default is the same file that was applied to the parent alignment. You may choose to use a different design criteria file for the profile. For this exercise, you will accept the default.

- 6 Under Use Design Check Set, click the arrow next to . Click  Create New.
In the next few steps, you will create a new design check set to validate that the sag and crest curves meet a minimum length value.
- 7 In the Profile Design Check Set dialog box, on the Information tab, for Name, enter Profile Curve Length.
- 8 On the Design Checks tab, in the Type list, select Curve. In the Curve Checks list, select L>=30. Click Add.
- 9 In the Design Check table, in the Apply To column, select Crest Curves Only.
- 10 Repeat Steps 8 and 9 to add the L>=60 curve design check to the design check set. In the Apply To column, select Sag Curves Only.
- 11 Click OK.
- 12 In the Create Profile - Draw New dialog box, click OK.
The Profile Layout Tools toolbar is displayed in the drawing window. You can start drawing the layout profile that refers to the criteria you specified.

To continue this tutorial, go to [Exercise 2: Drawing a Profile that Refers to Design Criteria](#) (page 299).

Exercise 2: Drawing a Profile that Refers to Design Criteria

In this exercise, you will draw a profile that refers to specified minimum standards.

You will use the standard profile layout tools to create a profile using the criteria-based design feature.

This exercise continues from [Exercise 1: Specifying Profile Design Criteria](#) (page 298).

For more information, see the AutoCAD Civil 3D Help topic *Creating Layout Profiles*.



Draw profile tangents

NOTE This exercise uses *Profile-4A.dwg* with the modifications you made in the previous exercise.

- 1 On the Profile Layout Tools toolbar, ensure that Draw Tangents  is selected.
- 2 In the profile view, snap to the center of each of the circles that are labeled A through E.
- 3 After you click in Circle E, right-click to end the profile.
The layout profile consists of tangents connected at points of vertical intersection (PVI). Next, you will add curves at each PVI.

NOTE For information about using object snaps, see the [Using Basic Functionality tutorial](#) (page 15).

Add a free curve that exceeds the design standards

- 1 On the Profile Layout Tools toolbar, click the arrow next to . Select  Free Vertical Curve (Parameter).
- 2 On the profile view, click the tangent that enters Circle B on the left (the “first entity”).
- 3 Click the tangent that exits Circle B on the right (the “next entity”).
On the command line, notice that you can select the parameter that you want to use to define the curve. The displayed value for the selected parameter is the minimum value that will meet the minimum K value that is required by the design criteria file. For this exercise, you will enter values that do not meet the design criteria, and then examine the results.
- 4 On the command line, enter R to specify a curve radius. Enter a radius of 500.

The curve is drawn between the tangents, and a  warning symbol is displayed. You will learn how to diagnose and correct the violations in [Exercise 3: Viewing and Correcting Profile Design Criteria Violations](#) (page 301).

- 5 Repeat steps 2 to 4 to add an identical curve to the PVI in Circle C.

Add a free curve that meets the design standards

- 1 On the profile view, click the tangent that enters Circle D on the left (the “first entity”).
- 2 Click the tangent that exits Circle D on the right (the “next entity”).
- 3 Press Enter to accept the minimum radius value that is displayed on the command line.

The curve is drawn at Circle D, but this time no warning symbol is displayed. You can use the command line to quickly apply minimum values to profile entities as you draw them.

- 4 Right-click to end the command.

To continue this tutorial, go to [Exercise 3: Viewing and Correcting Profile Design Criteria Violations](#) (page 301).

Exercise 3: Viewing and Correcting Profile Design Criteria Violations

In this exercise, you will check the profile design for criteria violations, and then learn how to correct violations.

When a profile sub-entity violates a criteria or design check, a warning symbol is displayed on the sub-entity in the drawing window, Profile Entities vista, and Profile Layout Parameters dialog box. When the cursor is hovered over a warning symbol, a tooltip displays information about the violation. If a design criteria has been violated, the tooltip displays the criteria that has been violated, as well as the minimum value that is required to meet the criteria. If a design check has been violated, the tooltip displays the name of the design check that has been violated.

For more information, see the AutoCAD Civil 3D Help topic *Viewing and Correcting Profile Design Criteria Violations*.

This exercise continues from [Exercise 2: Drawing a Profile that Refers to Design Criteria](#) (page 299).

Check the profile design for criteria violations

- 1 Open *Profile-4B.dwg*, which is located in the [tutorial drawings folder](#) (page 819).
- 2 Pan and zoom so that you can see Circles B and C on the profile view.



NOTE The warning symbols do not automatically scale when you zoom in. Enter REGEN on the command line to resize the warning symbols.

- 3 Hover the cursor over the  symbol in Circle C. The tooltips are a convenient way to review design criteria violations in the drawing window. Two violations are displayed in the tooltip:

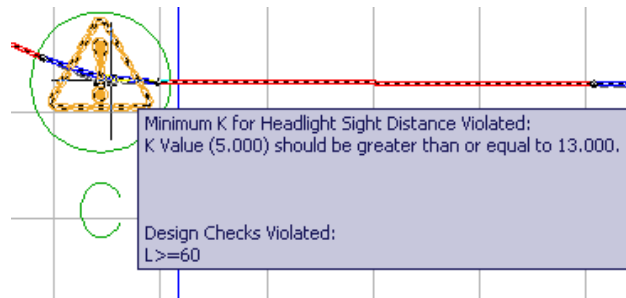
- First, the curve does not meet the recommended minimum K value for headlight sight distance. The curve K value and minimum acceptable K value are both displayed.
- Second, the curve does not meet the formula specified in one of the design checks. Notice that the name of the design check is displayed, but not the current or recommended values. Values are not displayed because design checks are custom formulas that are created by the user.



NOTE If a sub-entity violates multiple criteria or design checks, only a single symbol is displayed on the sub-entity. To clear a symbol from a sub-entity, all the violations must be cleared.

- 4 If the Profile Layout Tools toolbar is not open, select the red layout profile. Right-click. Click Edit Profile Geometry.
- 5 On the Profile Layout Tools toolbar, click  Entity Based.
- 6 Click  . Profile Grid View

In the Profile Entities vista, in rows 2 and 4, notice that a  warning symbol appears in the No. column, as well as several other columns.

Warning symbols appear next to each value that violates the design criteria that are specified in the design criteria file.

- 7 In row 2, hover the cursor over the  warning symbol in the No. column.

Notice that the tooltip displays the design criteria and design checks that have been violated. Notice that while the two curves violate the minimum length specified by the design checks, a warning symbol does not appear in either Length cell. Design checks are custom, mathematical formulas that return either a true or false value. They do not provide feedback other than whether the applicable entities meet or violate the conditions in the design check.

- 8 On the Profile Layout Tools toolbar, click  Profile Layout Parameters. The Profile Layout Parameters window is displayed, containing no data.
- 9 In the Profile Entities vista, click row No. 4, which is the curve entity in Circle C.

The design data for the curve entity is displayed in a three-column table in the Profile Layout Parameters window, where data is easy to review and edit.

Notice that in the Profile Layout Parameters window, in the Design

Criteria panel, a  symbol is displayed next to the design criteria property that has been violated. In the Layout Parameters panel, the Value column displays the actual parameters of each sub-entity. The Constraints column displays the design criteria values that the sub-entities

must meet. A  symbol is displayed next to the K Value row because the value violates the design criteria. As is true in the drawing window and Profile Entities Vista, the design check that has been violated is displayed, but individual parameters that violate the check are not marked.

Correct the design criteria violations

- 1 In the Profile Layout Parameters window, on the Layout Parameters panel, change the Length Value to 60.000m. Press Enter.

Notice that the warning symbol is cleared from the Design Checks panel, as well as from row 4 in the Profile Entities vista. The new curve length value meets the value specified by the design check. Increasing the curve length also affected the K value, which increased to meet the minimum value for Headlight Sight Distance.

- 2 In the Profile Entities vista, click row No. 2, which is the curve entity in Circle B.
- 3 In the Profile Layout Parameters window, on the Layout Parameters panel, change the Length Value to 30.000m. Press Enter.

The  warning symbol is cleared from the Design Checks panel, but not from the K Value row or the Profile Entities vista.

The curve still does not meet the minimum K value for passing sight distance, so the warning symbols are displayed. To clear a warning symbol, the entity must meet all values specified in both the design criteria file and the applicable design checks.

TIP There are two recommended methods for working around a Minimum K For Passing Sight Distance violation:

- Add a new design speed at the station at which the curve begins. You can do this in the Alignment Properties dialog box, on the Design Criteria tab.
 - Designate the station range along curve as a No Passing Zone. This solution does not clear the warning symbol from the drawing, so you should annotate the symbol and No Passing Zone in the final plot.
-

To continue to the next tutorial, go to [Displaying and Modifying Profile Views](#) (page 304).

Tutorial: Displaying and Modifying Profile Views

This tutorial demonstrates how to change the appearance of profile views.

You may change profile view style, add labels and data bands, split a profile view, and create multiple profile views to suit your production requirements.

The *profile view style* controls the format for titles, axis annotation, and other elements of a profile view.

Multiple profile views are useful for plotting short segments of a profile in separate profile view grids of a consistent length and vertical scale.

A profile can be *split* within either a single or multiple profile view. Splitting a profile allows a profile view to display a profile elevation range that is greater than the profile view's specified height.

Multiple profile views are most useful when you are creating final construction documents from your design. For best results, design your profile in a single profile view, then use the plan production tools to create multiple profile views.

When you must annotate centerline and offset profiles extensively, you can create *stacked* profile views, in which each profile line is displayed in a separate profile view grid.

For more information, see the AutoCAD Civil 3D Help topic *Working with Profile Views*.

Exercise 1: Editing the Profile View Style

In this exercise, you will learn how to change the data displayed in a profile view.

You use the Profile View Style dialog box to define profile view styles that control the format for titles, axis annotation, and other elements of a profile view.

The Profile View Properties dialog box is the central location in which you can modify all components of the profile view, including profiles, labels, styles, and data bands.

You can also do some common editing tasks, such as deleting profiles or modifying profile labels, within the drawing window by right-clicking the appropriate object.

For more information, see the AutoCAD Civil 3D Help topic *Editing Profile Views*.

Change the profile view style

- 1 Open *Profile-5A.dwg*, which is located in the [tutorial drawings folder](#) (page 819).
- 2 Click the grid to select profile view profile view PV- (1). Right-click. Click Profile View Properties.
- 3 Click the Information tab.
- 4 In the Object Style field, change the profile view style to Major Grids. Click Apply.

Notice that this style change affects the X-axis annotation as well as the grid.

- 5 Click  Edit Current Selection.
- 6 In the Profile View Style dialog box, examine the contents of the various tabs to see the many settings that can be included in a style definition. For example, on the Title Annotation tab, you can change the format and location of the profile view title. On the Display tab, you can turn various parts of the profile view on and off.
- 7 Click Cancel, and then click OK to close the Profile View Properties dialog box.
- 8 Zoom out so you can see both profile views.
When you applied the Major Grids style, which includes grid padding above and below the profile, PV- (1) enlarged to overlap PV- (2).
- 9 Click PV- (2) and move it up above the title block for PV- (1).

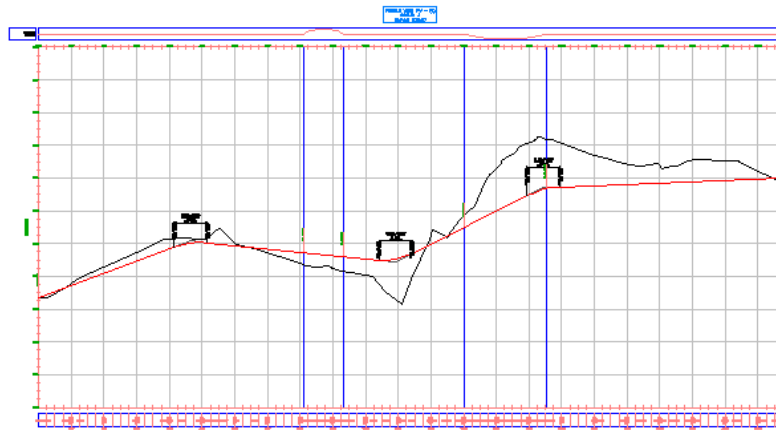

Now you will edit the Major Grids profile view style to add consistent grid padding, clip the profile view grid, and modify the appearance of the ticks along the axis.

Modify the grid in the profile view style

- 1 Click the PV - (1) grid to select the profile view. Right-click. Click Edit Profile View Style.
- 2 In the Profile View Style dialog box, on the Grid tab, under Grid Padding, change the padding of all four axes to 1.0000.
- 3 Click Apply.

Notice that in the drawing, there is now one full major grid between the profiles and the profile view extents.

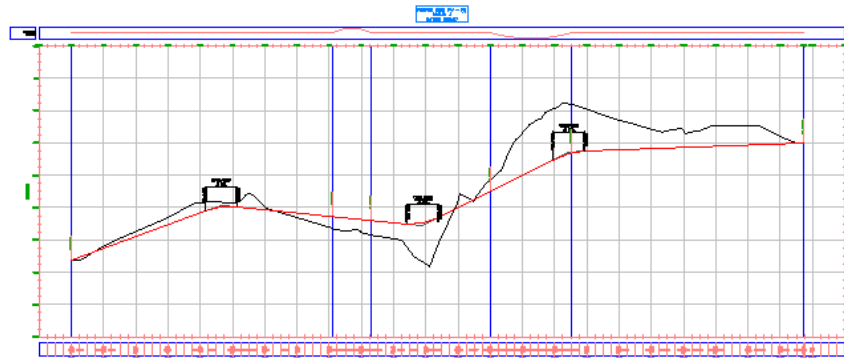

- 4 Under Grid Options, select Clip Vertical Grid and Clip Horizontal Grid. Under both selections, select Omit Grid In Padding Areas.

Notice that the graphics in the dialog box change to demonstrate the effect the setting has on the profile view.

- 5 Click Apply.

Notice that in the drawing, the profile view grid has been removed from above the surface profile and the padding area you specified.

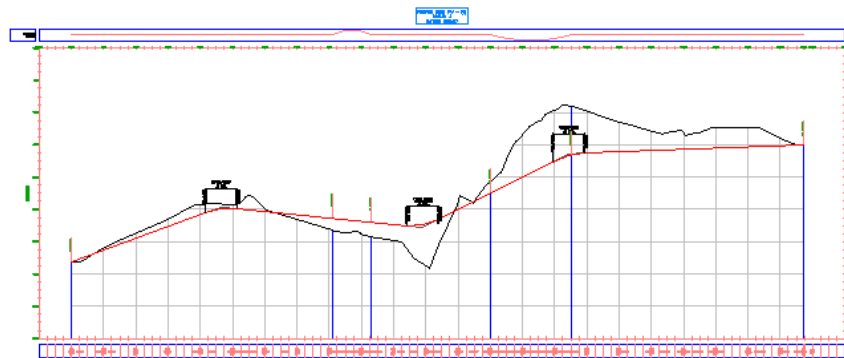

The grid is clipped to the surface profile because the Clip Grid setting in the profile view properties for PV - (1) is set to the centerline surface profile. Setting the profile view style to Clip To Highest Profile(s) would override the property setting and clip the grid to the layout profile.

- 6 Click OK.

NOTE If the style changes have not been applied to the profile view, enter REGEN at the command line.

Modify the axis annotation in the profile view style

- 1 Pan and zoom to see the upper left corner of the profile view grid. Zoom in so you can clearly see the tick marks on the horizontal and vertical axes.

Notice that the starting station labels overlap. In the next few steps, you will correct the overlap and modify the justification of the ticks at the major stations.

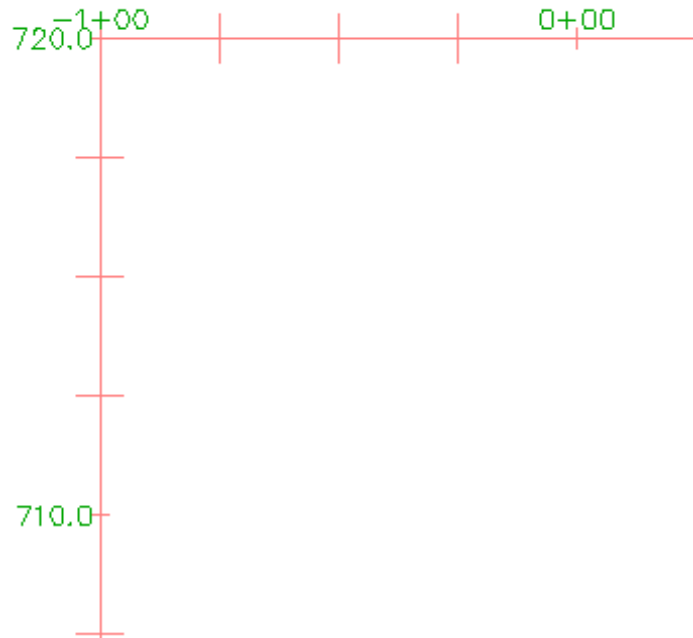

- 2 Click the grid to select the profile view. Right-click. Click Edit Profile View Style.
- 3 In the Profile View Style dialog box, on the Horizontal Axes tab, click Top.
This control sets the focus of the controls on this tab to the top axis. If, after you have changed the top axis, you would like the changes to carry over to the bottom axis, select Bottom and repeat the changes.

NOTE The bottom axis controls the major and minor grid spacing.

4 Under Major Tick Details, specify the following parameters:

- Tick Size: 0.2500
- Y Offset: 0.1000

5 Click Apply.

The major ticks are longer, and the station labels move up.

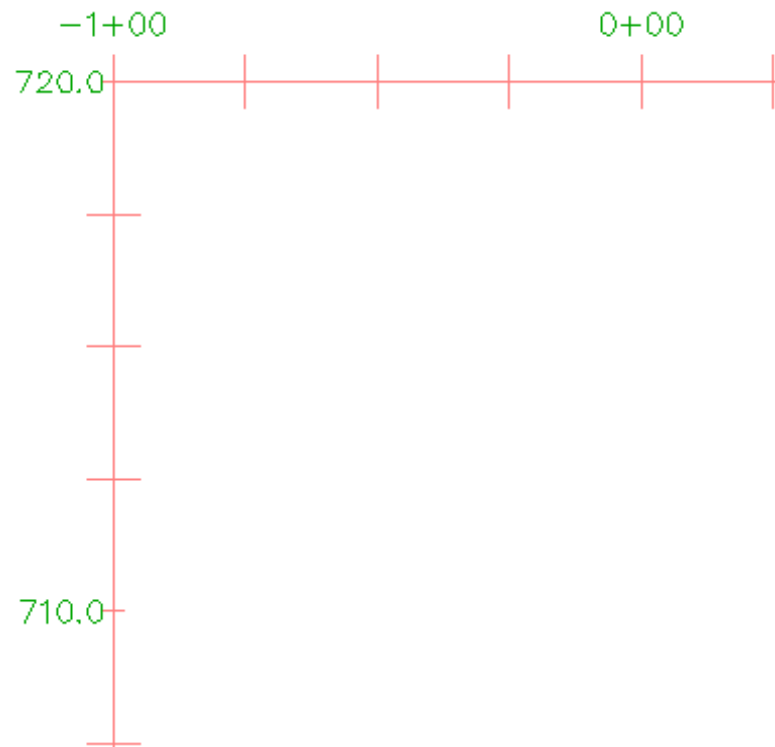

6 On the Vertical Axes tab, make sure Left is selected as the axis to control.

NOTE The left axis controls the major and minor grid spacing.

7 Under Major Tick Details, specify the following parameters:

- Tick Size: 0.2500

■ X Offset: -0.1000

8 Click OK.

The ticks are longer, and the elevation labels move to the left.

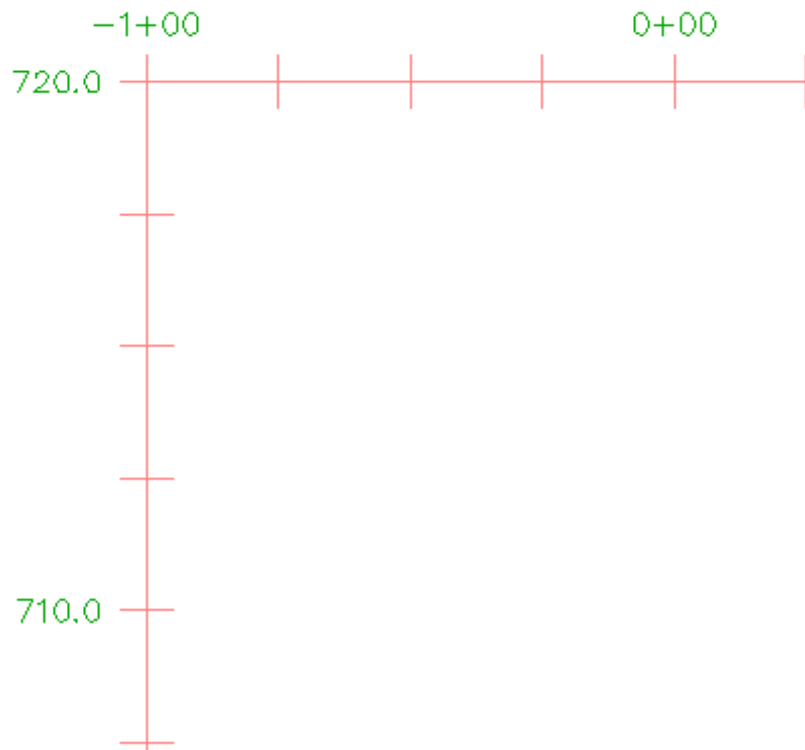

Further exploration: Experiment with the other settings in the Major Tick Details area. Make the same changes you made in the previous steps to the right axis.

To continue this tutorial, go to [Exercise 2: Adding Hatch Patterns Between Profiles](#) (page 310).

Exercise 2: Adding Hatch Patterns Between Profiles

In this exercise, you will illustrate the cut and fill regions along an alignment by applying hatch patterns between the surface and layout profiles.

Hatch patterns can be applied to areas that are formed by two profile lines. Hatch patterns are applied in the Profile View Properties dialog box. You can either specify the area type, or use an existing quantity takeoff criteria. You use shape styles to apply the desired hatch patterns and colors to the areas you have defined.

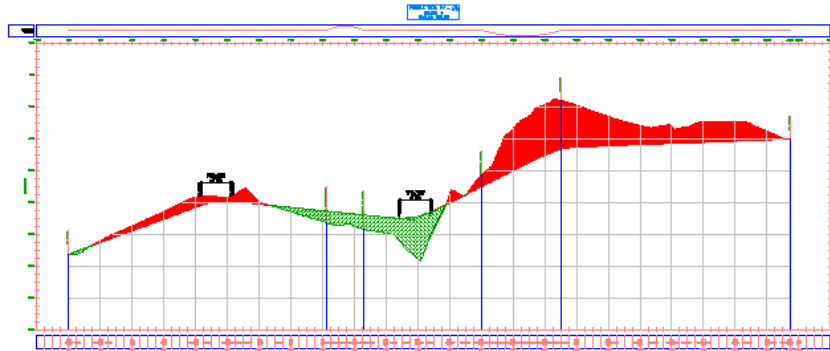

For more information, see the AutoCAD Civil 3D Help topic *Adding Hatch Areas to a Profile View*.

This exercise continues from [Exercise 1: Editing the Profile View Style](#) (page 305).

Access the profile view properties

- 1 Open *Profile-5B.dwg*, which is located in the [tutorial drawings folder](#) (page 819).

This drawing is similar to the drawings you used in previous profiles tutorial exercises. This drawing contains an additional profile view, Profile View PV - (3), which contains an existing ground and layout profile. You will add hatch patterns that highlight the cut and fill areas between the two profiles.

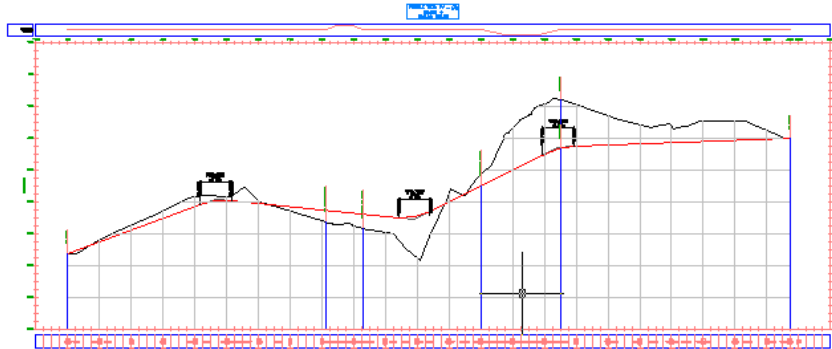

- 2 Click the Profile View PV - (3) grid to select the profile view. Right-click. Click Profile View Properties.

Define a cut area hatch

- 1 In the Profile View Properties dialog box, on the Hatch tab, click

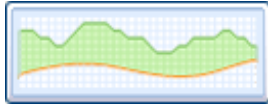

Cut Area.

A Cut - (1) area is displayed in the Hatch Area table. For Upper Boundary, the first surface profile in the list is automatically assigned. For Lower Boundary, the first layout profile in the list is assigned automatically.

- 2 In the Shape Style column, click Standard.
- 3 In the Pick Shape Style dialog box, select Cut. Click OK.
- 4 In the Profile View Properties dialog box, click Apply.
The specified shape style is displayed in the cut areas between the profiles.

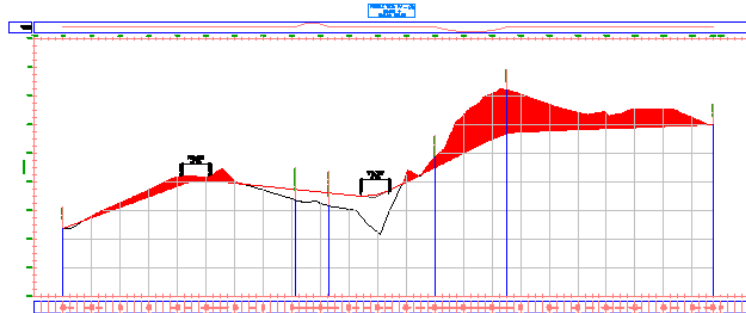

Define a fill area hatch

- 1 In the Profile View Properties dialog box, on the Hatch tab, click

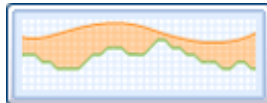



Fill Area.

A Fill - (1) area is displayed in the Hatch Area table. For Upper Boundary, the first layout profile in the list is automatically assigned. For Lower Boundary, the first surface profile in the list is assigned automatically.

- 2 In the Fill - (1) entry, for Shape Style, click the Standard entry.
- 3 In the Pick Shape Style dialog box, expand the list of shape styles.
An appropriate Fill style does not exist in this drawing. You will create one in the following steps.

Create a fill shape style

- 1 In the Pick Shape Style dialog box, select Cut.
- 2 In the Pick Shape Style dialog box, click the down arrow next to .
Click  Copy Current Selection.
- 3 In the Shape Style dialog box, on the Information tab, for Name, enter Fill.
- 4 On the Display tab, under View Direction, select both entries in the Component Display table.
- 5 Click one of the Color cells.

- 6 In the Select Color dialog box, for Color, enter 92. Click OK.
- 7 In the Component Hatch Display table, for Pattern, click the Dash entry.
- 8 In the Hatch Pattern dialog box, for Pattern Name, select Cross.
- 9 Click OK four times.

The Profile View Properties dialog box closes, and the new hatch pattern is displayed in the fill areas between the profiles.

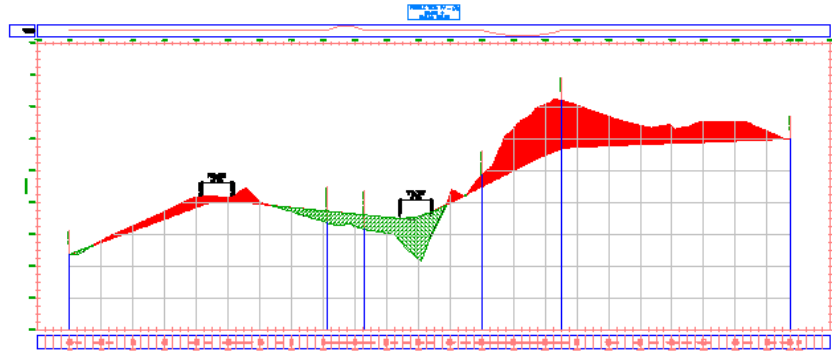

To continue this tutorial, go to [Exercise 3: Projecting Objects onto a Profile View](#) (page 314).

Exercise 3: Projecting Objects onto a Profile View

In this exercise, you will project multi-view blocks, COGO points, and 3D polylines from plan view onto a profile view.

You can project a variety of objects, such as AutoCAD points, solids, blocks, multi-view blocks, 3D polylines, COGO points, feature lines, and survey figures onto a profile view. The process you will use in this exercise can be applied to any of these objects.

NOTE Before you project an object into a profile view, make sure that the object has a defined elevation. Otherwise, the elevation may be zero, and the profile view will be expanded vertically to accommodate the zero elevation value.

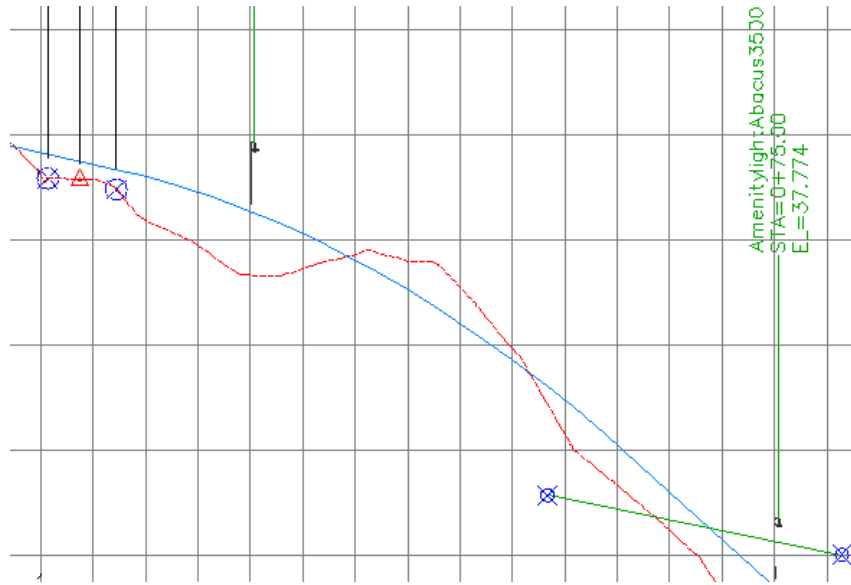

For more information, see the AutoCAD Civil 3D Help topic *Working with Projected Objects*.

Project multi-view blocks onto a profile view

- 1 Open *Profile-5C.dwg*, which is located in the [tutorial drawings folder](#) (page 819).

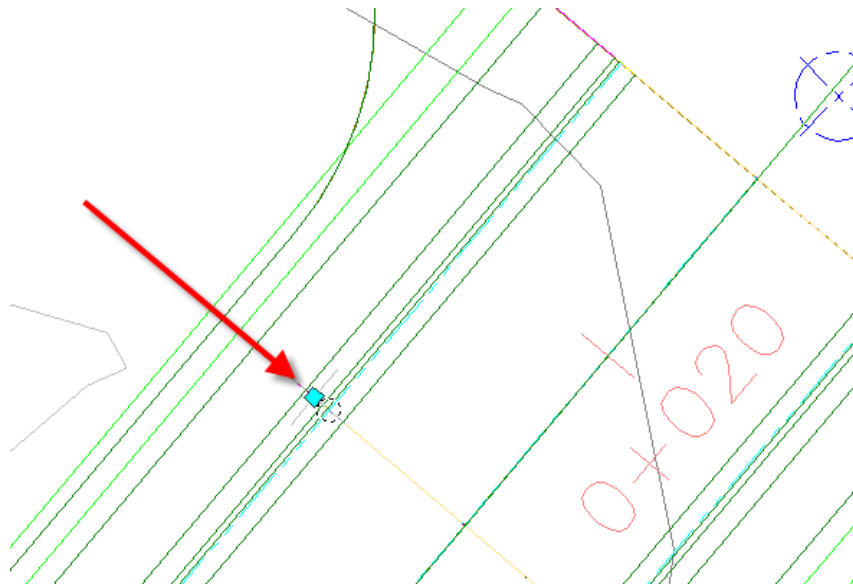

Two viewports are displayed in this drawing. A plan view of COGO points that represent an existing road, and a proposed corridor is displayed in the left viewport. A profile view that contains existing ground and proposed ground profiles of the proposed road is displayed in the right viewport.

- 2 In the left viewport, at station 0+025, select the multi-view block that represents a light post. Right-click. Click Select Similar.



All the light posts along the proposed road corridor are selected.

When you insert a multi-view block into a drawing, it is created as a standard AutoCAD block. Before it can be projected onto a profile view, a multi-view block must be exploded from its original AutoCAD block form.

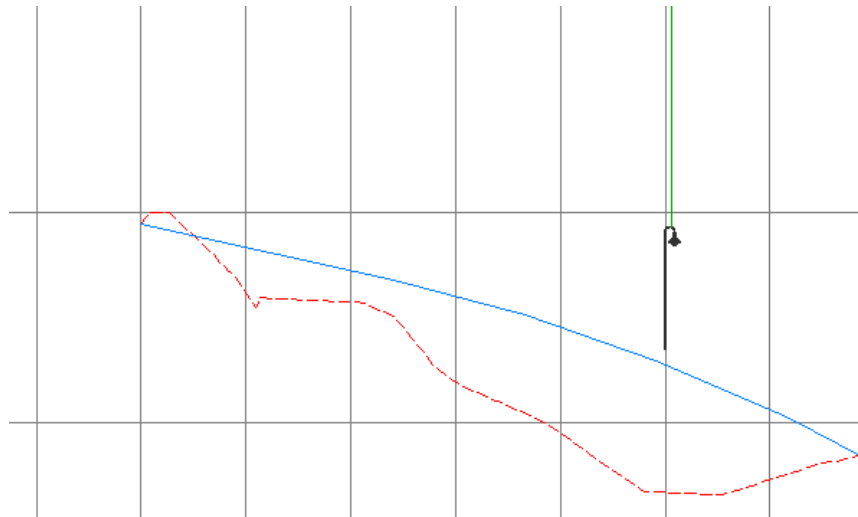

- 3 Click Home tab ► Profile & Section Views panel ► Profile View drop-down ►  Project Objects To Profile View.
- 4 In the right viewport, click the profile view grid.
- 5 In the Project Objects to Profile View dialog box, click  <Set All> in each column to specify the following parameters:
 - Style: Projection Without Exaggeration
 - Elevation Options: Surface ► First Street Surface
 - Label Style: Object Name Station And Elevation
- 6 Click OK.
The light poles are displayed on the profile view.



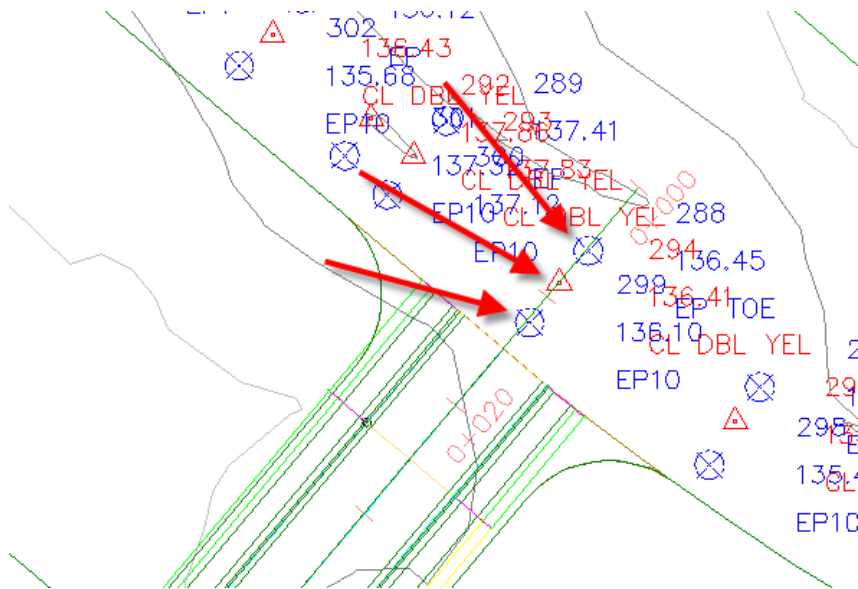

Project COGO points and 3D polylines onto a profile view

- 1 In the left viewport, select the three COGO points that are along the proposed road centerline.

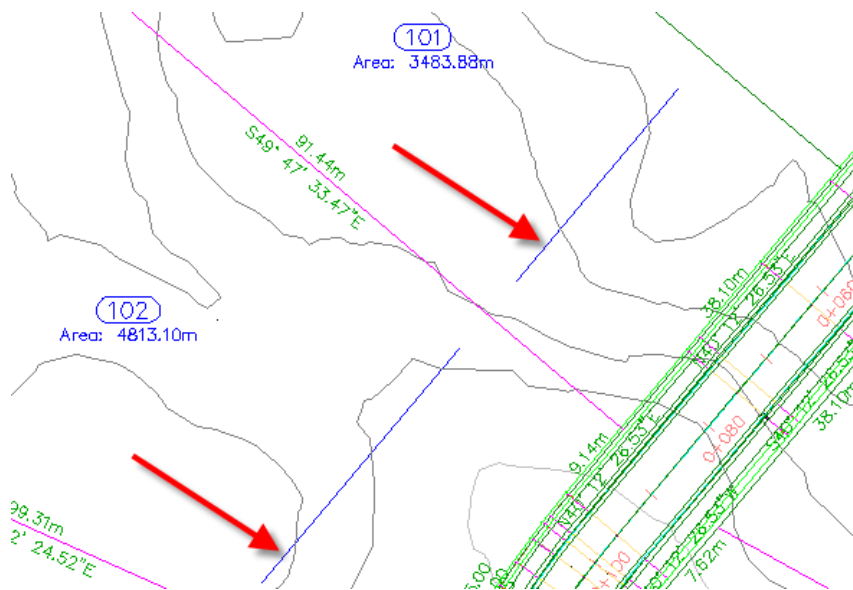

- 2 Click Home tab ► Profile & Section Views panel ► Profile View drop-down ►  Project Objects To Profile View.
- 3 In the right viewport, click the profile view grid.
- 4 In the Project Objects To Profile View dialog box, click  Pick Objects.
- 5 In the left viewport, zoom out and select each of the blue 3D polylines that represent the front of building footprints.



- 6 Press Enter.
- 7 In the Project Objects To Profile View dialog box, in the  3D Polylines row, under Style, click  <Set All>.
- 8 In the Select Projection Style dialog box, select Projection Without Exaggeration.

Leave the Elevation Options setting at  Use Object. In this case, the appropriate elevation value is a property of the selected objects.
- 9 Click OK twice.

The COGO points and building 3D polylines are displayed in the profile view.

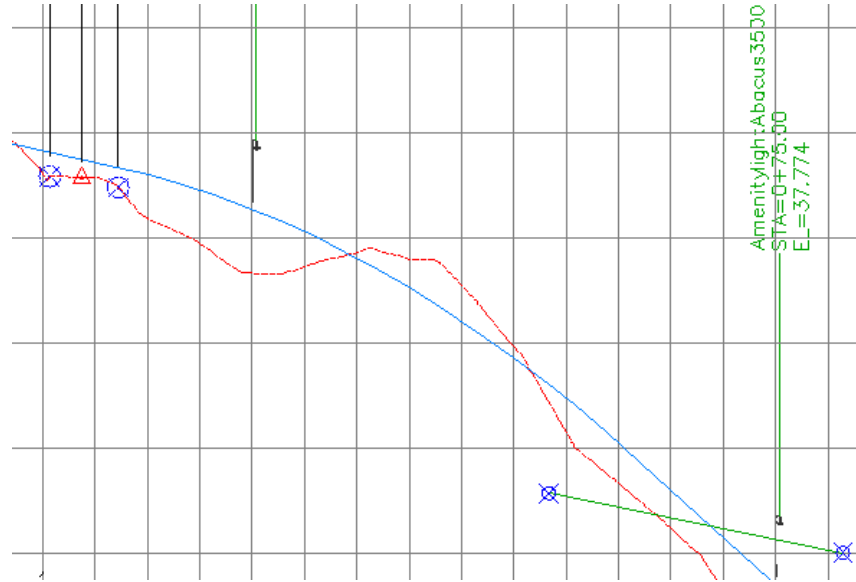

Edit the projected object elevation

- 1 In the left viewport, select the 3D polyline in parcel 101.

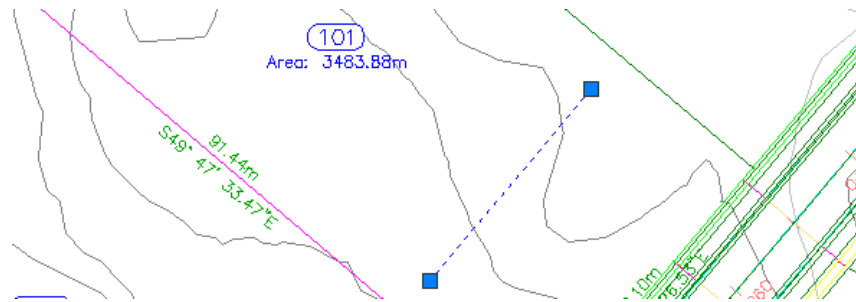

- 2 On the command line, enter LIST.
In the AutoCAD Text Window, notice that the elevation values for the polyline vertices are approximately 38.
- 3 Press Enter. Close the AutoCAD Text Window.

- In the right viewport, select the 3D polyline that crosses between stations 0+060 and 0+080.

When you select the 3D polyline in the profile view, notice that the 3D polyline in plan view is highlighted.

- Drag the left grip down toward the bottom of the profile view.

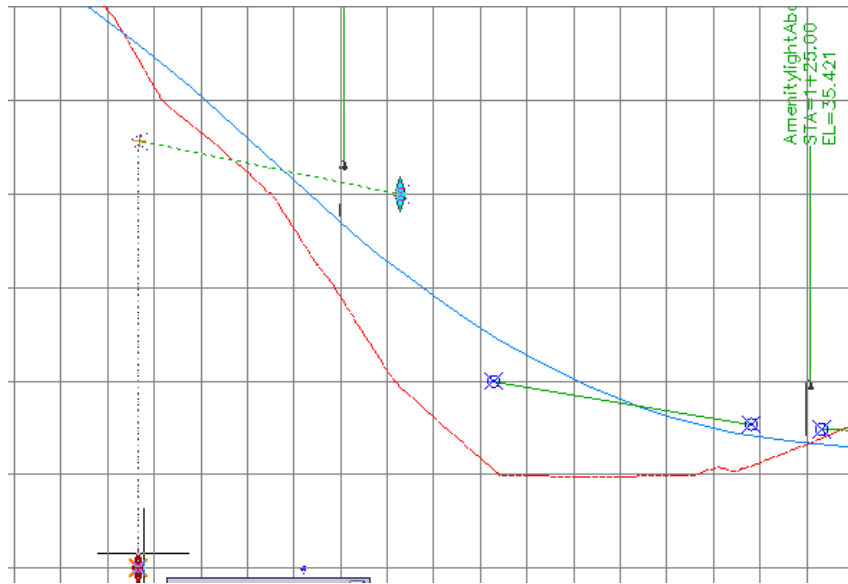

- Repeat Steps 1 and 2 to examine the new elevation value.
When you grip edit a projected feature line or 3D polyline, the corresponding elevation of the source object is adjusted.
- Press Enter. Close the AutoCAD Text Window.

Modify the display of projected objects in profile view

- In the right viewport, select the profile view grid. Right-click. Click Profile View Properties.
The Projections tab is displayed on the Profile View Properties dialog box. You use the controls on this tab to change the parameters that you used when you projected objects onto the profile view.

NOTE Like other AutoCAD Civil 3D labels, label parameters are changed by selecting the desired label, and then using the Labels contextual tab on the ribbon.

- 2 In the Profile View Properties dialog box, on the Projections tab, clear the  3D Polylines check box.
- 3 Click Apply.
The 3D polylines are removed from the profile view, and are cleared from the Profile View Properties dialog box.
- 4 Click OK.

Further exploration: Examine the style settings that are available for projected objects. Projected object styles are located in Toolspace, on the Settings tab, in the General ► Multipurpose Styles ► Projection Styles collection. Label styles for projected objects are located in Toolspace, on the Settings tab, in the Profile View ► Label Styles ► Projection collection.

To continue this tutorial, go to [Exercise 4: Splitting a Profile View](#) (page 321).

Exercise 4: Splitting a Profile View

In this exercise, you will split a profile view so that the full elevation range of a layout profile fits in a shorter profile view.

For more information, see the AutoCAD Civil 3D Help topic *Working with Profile Views*.

This exercise continues from [Exercise 3: Projecting Objects onto a Profile View](#) (page 314).

Split a profile view

- 1 Open *Profile-5D.dwg*, which is located in the [tutorial drawings folder](#) (page 819)
- 2 Click Home tab ► Profile & Section Views panel ► Profile View drop-down ►  Create Profile View.
- 3 In the Create Profile View wizard, on the General page, specify the following parameters:
 - Select Alignment: Ridge Road

- Profile View Style: Standard
- 4 On the left side of the wizard, click Profile View Height.
 - 5 On the Profile View Height page, specify the following parameters:
 - Profile View Height: User Specified
 - Maximum: 670.00'
 - Split Profile View: Selected
The split profile view controls are now available. These controls allow you to select separate profile view styles for the first, intermediate, and last segments of the split profile view. For this exercise, accept the default split profile view settings.
 - 6 Click Next.
 - 7 On the Profile Display Options page, clear the Draw check boxes for all profiles except EG - Surface (1) and Layout (1). In the Layout (1) row, select the Split At option. This option specifies that the split occurs at the appropriate elevation of the layout profile and ensures that the entire layout profile will appear in the profile view.
 - 8 Scroll to the right until the Labels column is visible. In the EG - Surface (1) row, click the Labels cell.
 - 9 In the Pick Profile Label Set dialog box, select <None>. Click OK.
 - 10 Click Create Profile View.
 - 11 When prompted, pan and zoom to a clear area in the drawing window, then click to create the profile view.

A new profile view is created. Notice that because you specified a shorter maximum height in step 7, the profile view grid is shorter than the other profile views in the drawing. In order to fit the profile in the shorter grid, the profile has been split in two segments. The full length and elevations of the red, layout profile are visible because you set the Split At setting to Layout (1) in step 6. Notice that there is a vertical axis in the middle of the profile view that displays the elevations for both split segments.

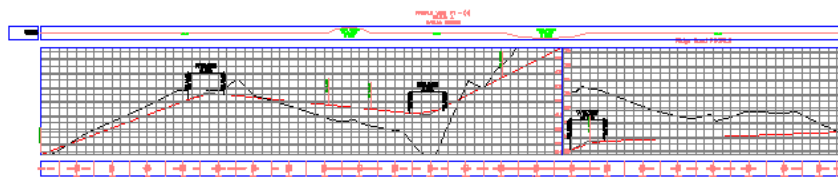

Modify the properties of the split profile view

- 1 In Toolspace, on the Prospector tab, expand the Alignments ► Centerline Alignments ► Ridge Road ► Profile Views collections.
Notice that a single new profile view (PV - (4)) was created.
- 2 On the Prospector tab, right-click PV - (4). Click Properties.
- 3 In the Profile View Properties dialog box, on the Elevations tab, under Elevation Range, change the Height to 15.000'.
- 4 Click Apply.
Notice that in the drawing window, the profile view has been split into five segments to accommodate the new height.

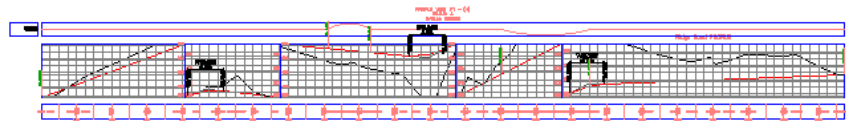

Now you will change the style of the first and last profile view segments.

- 5 In the Profile View Properties dialog box, in the Split Profile View Data table, in the No. 1 row, in the Profile View Style column, click .
- 6 In the Pick Profile View Style dialog box, select Left & Bottom Axis. Click OK.
- 7 Repeat steps 5 and 6 to change the Profile View Style in row No. 4 to Full Grid.
- 8 Click OK.

Three different profile view styles are displayed in the single profile view grid. While a split profile is displayed in a single profile view grid, it may have separate styles applied to each of its split segments.

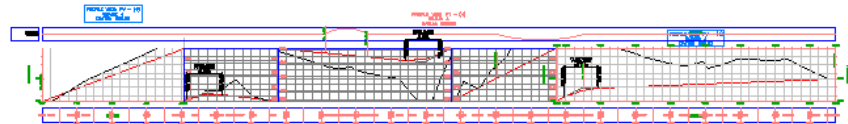

To continue this tutorial, go to [Exercise 5: Creating Multiple Profile Views](#) (page 324).

Exercise 5: Creating Multiple Profile Views

In this exercise, you will produce a set of profile views to display short, successive segments of a profile.

Multiple profile views are most useful when you are creating final construction documents from your design. For best results, design your profile in a single profile view, then use the plan production tools to create multiple profile views for plotting or publishing. During the plan production process, you create sheets that display sections of alignments and profiles.

In this exercise, you will bypass the plan production tools to create multiple profile views in a currently open drawing. You will use the Create Multiple Profile Views wizard, which allows you to quickly specify the profile view properties before you create them. If you access this wizard during the plan production process, many of the properties are not available because they are already set in the *view frame group*.

For more information, see the AutoCAD Civil 3D Help topic *Working with Profile Views*.

For a tutorial that demonstrates the plan production tools, go to [Plan Production Tutorials](#) (page 805).

This exercise continues from [Exercise 4: Splitting a Profile View](#) (page 321).

Create multiple profile views

- 1 Open *Profile-5E.dwg*, which is located in the [tutorial drawings folder](#) (page 819).
This drawing contains two roads, Maple Road and Oak Road, and a single profile view of Oak Road.
- 2 Click Home tab ► Profile & Section Views panel ► Profile View drop-down ►  Create Multiple Profile Views.
- 3 In the Create Multiple Profile Views wizard, on the General page, specify the following parameters:
 - Select Alignment: Oak Road
 - Profile View Style: Major Grids
- 4 Click Next.
- 5 On the Station Range page, in the Length of Each View box, enter 500.00'.
- 6 Click Next.

- 7 On the Profile View Height page, specify the following parameters:
 - Profile View Height: User Specified
 - User Specified: 50.00'
 - Profile View Datum By: Mean Elevation
This option specifies that the profile lines will be positioned in the profile based on the mean of the highest and lowest elevation value of the profiles that are drawn in the grid. This option provides an equal amount of space above and below the profile lines. This option is useful when you have to annotate a profile that has fairly consistent elevation values.
 - Split Profile View: Selected
This option makes the split profile view controls available, which allow you to select separate profile view styles for the first, intermediate, and last segments of any split profile views. For this exercise, accept the default split profile view settings.
- 8 Click Next.
- 9 On the Profile Display Options page, ensure that the Draw check box is selected for both profiles.
- 10 In the Oak Road - Proposed row, select the Split At option.
This option specifies that if the profiles contained in the profile view must be split to fit in the specified profile view height, the split will occur at the appropriate elevation of the layout profile. This option ensures that the entire layout profile appears in the profile view.
- 11 Click Next to open the Pipe Network Display page.
You can use this page to select the pipe network or parts that you want to display in the profile view. For this exercise, you will not display any pipe network parts.
- 12 Click Next.
- 13 On the Data Bands page, under Select Band Set, select EG-FG Elevations and Stations.
- 14 Click Next to open the Profile Hatch Options page.
You can use this page to specify hatch patterns between the profiles in the profile view. For this exercise, you will not specify any hatch patterns.
- 15 Click Next.

- 16 On the Multiple Plot Options page, set Maximum in a Row to 4.
- 17 Click Create Profile Views.
- 18 When prompted, pan and zoom to a clear area in the drawing window, then click to create the profile views.

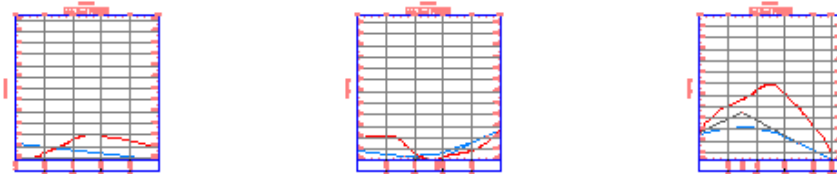

- 19 In Toolspace, on the Prospector tab, expand the Alignments, Oak Road, and Profile Views collections.
Notice that a separate profile view was created for each 500.00' segment.

To continue this tutorial, go to [Exercise 6: Creating Stacked Profile Views](#) (page 326).

Exercise 6: Creating Stacked Profile Views

In this exercise, you will create a series of three profile views that contain a centerline and left and right offset profiles.

Stacked profile views are a collection of related profiles that are drawn in separate, vertically arranged profile views. When each profile is displayed on its own profile view grid, more space is available to annotate each profile.

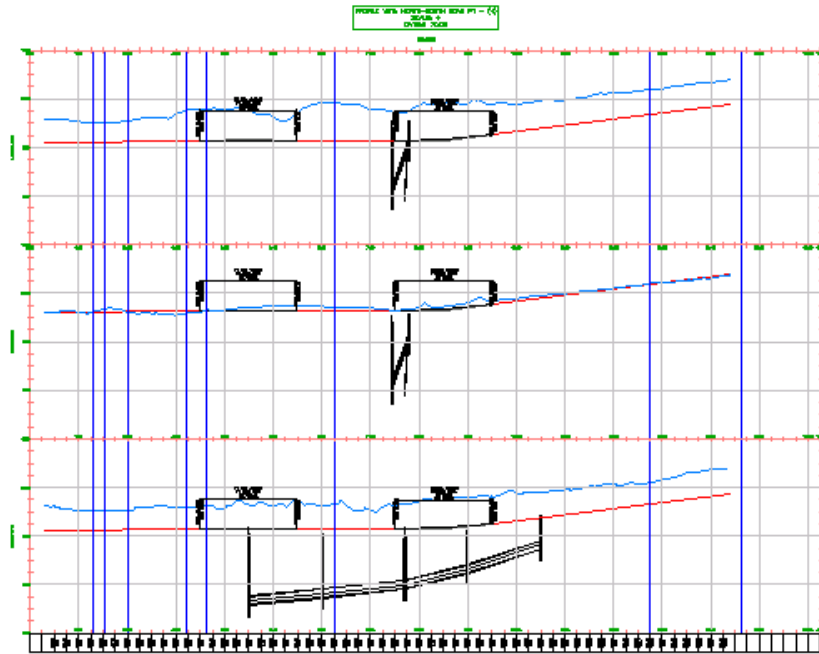

For more information, see the AutoCAD Civil 3D Help topic *Working with Profile Views*.

This exercise continues from [Exercise 5: Creating Multiple Profile Views](#) (page 324).

Create stacked profile views

- 1 Open *Profile-5F.dwg*, which is located in the [tutorial drawings folder](#) (page 819).

The drawing contains an existing ground surface, several alignments, and a profile view. The profile view contains centerline and left and right edge of pavement (EOP) profiles of the alignment that travels from North to South along the West side of the site. Because the profiles are crowded in the profile view, you will create a series of stacked profile views so that you can see the profiles clearly and have ample room for annotation.

- 2 Click Home tab ► Profile & Section Views panel ► Profile View drop-down ►  Create Profile View.

- 3 In the Create Profile View wizard, on the General page, specify the following parameters:
 - Select Alignment: North-South Road
 - Show Offset Profiles By Vertically Stacking Profile Views: Selected
The graphic at the bottom of the page changes color to indicate that the option is active.

NOTE The Profile View Style setting on this page is not used. You will assign separate styles for each profile view in the stack.

- 4 On the left side of the Create Profile View wizard, click Stacked Profile.
- 5 On the Stacked Profile page, specify the following parameters:
 - Number Of Stacked Views: 3
 - Gap Between Views: 0

NOTE The Gap Between Views value is measured in drawing units. A positive value adds space between the profile view grids. A negative value causes the profile view grids to overlap.

- Top View Style: Stacked - Top
 - Middle View Style: Stacked - Middle
 - Bottom View Style: Stacked - Bottom
- 6 Click Next.
 - 7 On the Profile Display Options page, in the Select Stacked View To Specify Options For list, select Middle View.

NOTE The number of views that is visible in this list depends on the value you specified for **Number Of Stacked Views** in Step 5.

- 8 In the Specify Profile Display Options table, select the Draw check box for the following profiles:
 - EG Centerline
 - Centerline
- 9 In the Select Stacked View To Specify Options For list, select Top View.

- 10** In the Specify Profile Display Options table, select the Draw check box for the following profiles:
 - EG Left Offset
 - EOP Left
- 11** In the Select Stacked View To Specify Options For list, select Bottom View.
- 12** In the Specify Profile Display Options table, select the Draw check box for the following profiles:
 - EG Right Offset
 - EOP Right
- 13** Click Next.
- 14** On the Pipe Network Display page, in the Select Stacked View To Specify Options For list, select Bottom View.

Most of the pipe network is on the right-hand side of the alignment. You will specify that the pipe network components will be displayed in the profile view that displays the right EOP profiles.
- 15** In the Select Pipe Network Parts To Draw In Profile View area, select the Select check box.
- 16** In the Name column, expand the Network - (1) pipe network.
- 17** Clear the check boxes for the following parts:
 - W-E Pipe - (1)
 - W-E Pipe - (2)
 - W-E Structure - (1)
 - W-E Structure - (2)

These parts are a branch of the pipe network that follow the West-East alignment.
- 18** In the Select Stacked View To Specify Options For list, select Middle View.
- 19** In the Select Pipe Networks To Draw In Profile View list, select the Select check box.
- 20** Clear all check boxes except for the following parts:
 - W-E Pipe - (1)

- W-E Pipe - (2)
 - W-E Structure - (1)
 - W-E Structure - (2)
- 21 In the Select Stacked View To Specify Options For list, select Top View.
- 22 In the Select Pipe Networks To Draw In Profile View list, select the Select check box.
- 23 Clear all check boxes except for the following parts:
- W-E Pipe - (1)
 - W-E Pipe - (2)
 - W-E Structure - (1)
 - W-E Structure - (2)
- 24 Click Create Profile View.
- 25 In the drawing, pan to the clear area at the right of the surface. Click to place the profile views.
- 26 In Toolspace, on the Prospector tab, expand the Alignments ► Road: North-South ► Profile Views collection.
Notice that three separate profile views were created.

To continue to the next tutorial, go to [Tutorial: Working with Data Bands](#) (page 330).

Tutorial: Working with Data Bands

This tutorial demonstrates how to add and change the appearance of data bands in a profile view.

Data bands can be placed at either the top or bottom of the profile view to annotate profile station and elevation data, vertical or horizontal geometry points, and so on. Data bands can be added to a profile view either as a set or individually.

NOTE Data bands are also used with section views. The tasks you will learn in the following exercises can be applied to profile views and section views.

For more information, see the AutoCAD Civil 3D Help topic *Adding Data Bands to a Profile View*.

Exercise 1: Adding Data Bands to a Profile View

In this exercise, you will add data bands along the bottom of a profile view.

For more information, see the AutoCAD Civil 3D Help topic *Adding Data Bands to a Profile View*.

Add profile view data bands

- 1 Open *Profile-6A.dwg*, which is located in the [tutorial drawings folder](#) (page 819).

The data band at the top of profile view PV - (3) shows the locations of horizontal curves in the parent alignment. Blue vertical lines cross the profile view grid to mark the start and end of each horizontal curve. The data band at the bottom annotates the elevation of both profiles at the major stations.

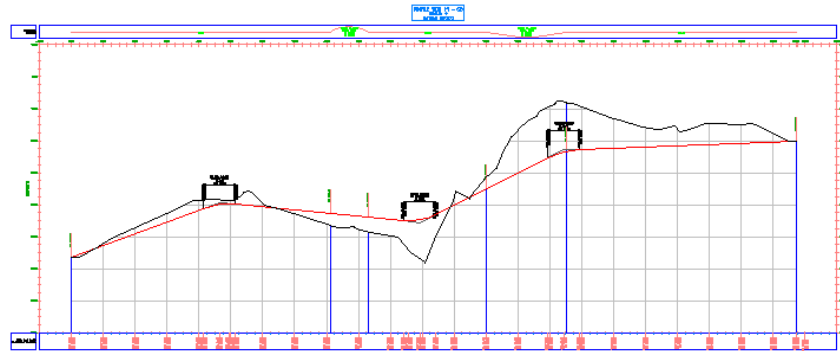

- 2 Select the profile grid. Right-click. Click Profile View Properties.
- 3 In the Profile View Properties dialog box, on the Bands tab, specify the following parameters:
 - Band Type: Vertical Geometry
 - Select Band Style: Geometry
 - Location: Bottom Of Profile View
- 4 Click Add.
The band is added to the bottom of the list.

5 Click Apply.

The new data band is displayed at the bottom of the stack of data bands. This data band labels the vertical geometry points of the first profile in the list. In this case, the existing ground profile was selected by default. You will change the referenced profile later in this exercise.

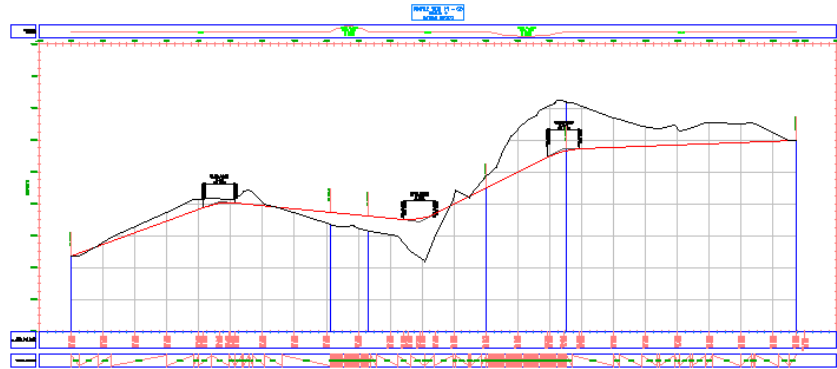

6 In the Profile View Properties dialog box, on the Bands tab, specify the following parameters:

- Band Type: Horizontal Geometry
- Select Band Style: Curvature
- Location: Bottom Of Profile View

7 Click Add.

8 Click Apply.

The horizontal geometry band is added to the bottom of the profile view in the drawing. This data band is drawn in a different style from the one along the top of the grid. However, both styles show the location of horizontal curves and are labeled with basic engineering data about the curves. These bands are useful for evaluating the design profile from a drainage and safety point-of-view.

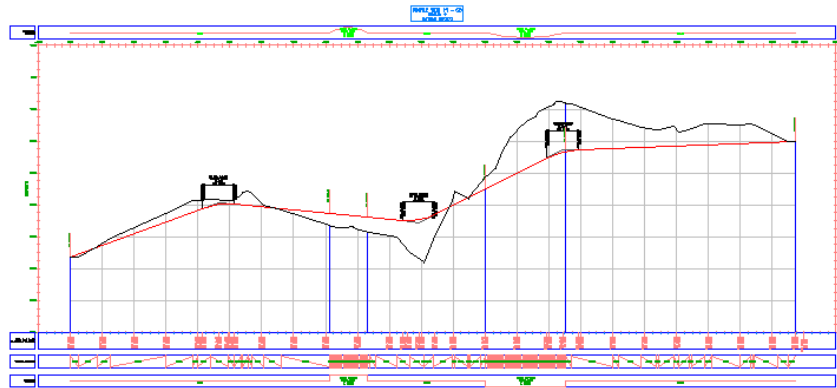

- 9 In the Profile View Properties dialog box, on the Bands tab, specify the following parameters:
 - Band Type: Profile Data
 - Select Band Style: Horizontal and Vertical Geometry Point Distance
 - Location: Bottom Of Profile View

- 10 Click Add.

In the Geometry Points To Label In Band dialog box, you can specify the individual horizontal and vertical geometry points to label using the current style. For this exercise, you will accept the default selections.

- 11 In the Geometry Points To Label In Band dialog box, click OK.

NOTE For more information on geometry point labeling, see the [Adding Labels in Groups tutorial exercise](#) (page 745).

- 12 Click Apply.

The new data band is displayed at the bottom of the stack of data bands. This data band labels the incremental distance between the horizontal geometry points of the parent alignment.

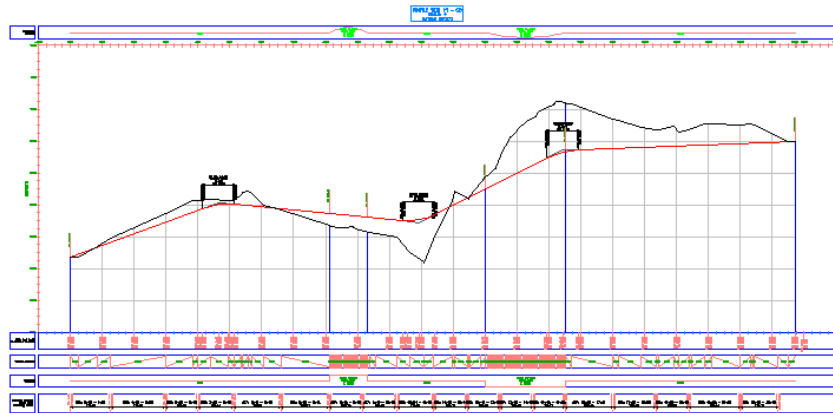

Change the profiles referenced in data bands

- 1 In the List Of Bands table, in the Profile1 column, change the value to Layout (1) for the Profile Data band at the bottom of the list.
- 2 Click Apply.

Now, the Profile Data band shows elevations of both the existing ground and finished grade profile at each major station. The Horizontal Geometry Point Distance band displays the finished ground elevation at each horizontal geometry point.

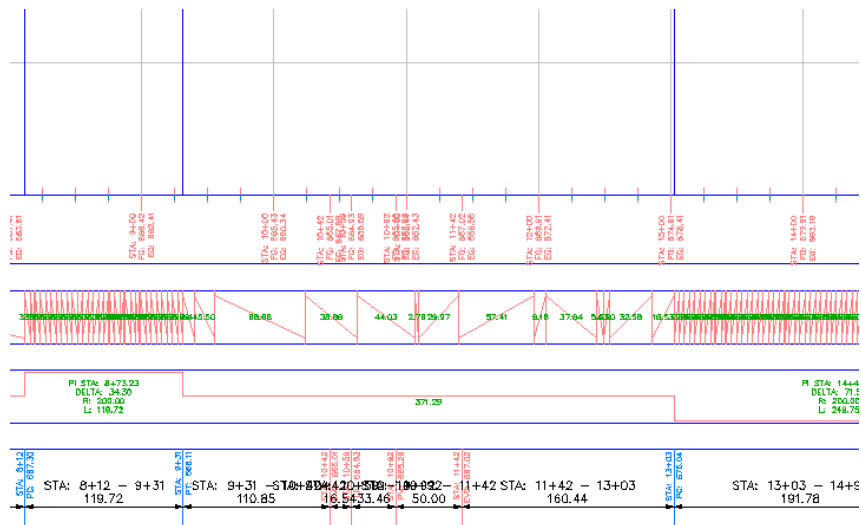

- 3 For the Vertical Geometry band, change the Profile1 setting to Layout - (1).
- 4 Click Apply.
Now, this band shows the length of each grade segment along the layout profile.

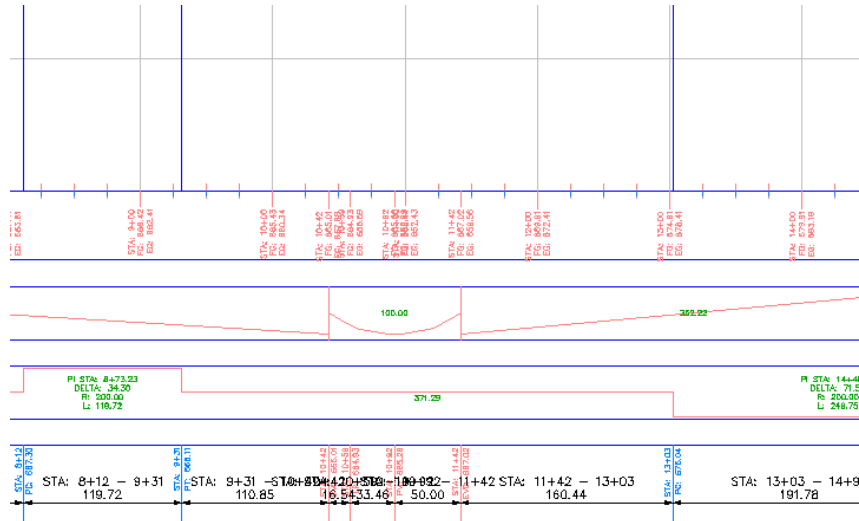

Rearrange the data bands

- 1 In the table of bands list, select the Vertical Geometry band. Click  twice, then click Apply.
The Vertical Geometry band moves to the bottom of the stack of data bands.
- 2 Click OK.
This arrangement of bands is convenient for analysis. It displays horizontal and vertical geometry, as well as comparative elevation data for the surface profile and the layout profile.
Notice that in the bottom, Vertical Geometry band, the labels in the uphill tangents are obscured by the tangents. You will correct this in [Exercise 3: Modifying a Data Band Style](#) (page 339).

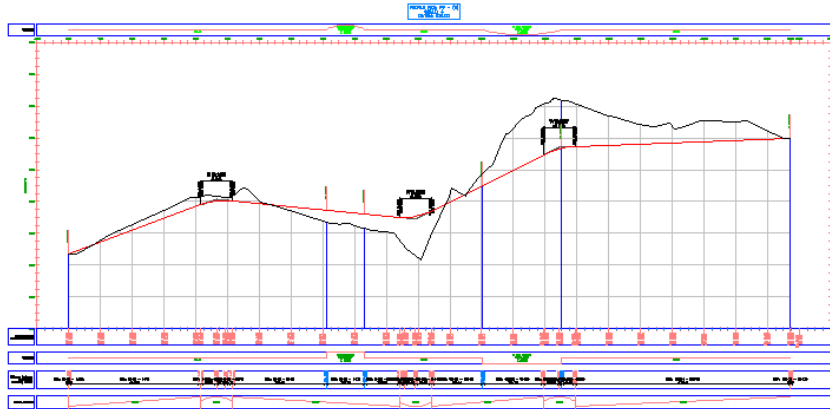

To continue this tutorial, go to [Exercise 2: Moving Labels in a Data Band](#) (page 336).

Exercise 2: Moving Labels in a Data Band

In this exercise, you will learn how to rearrange labels in data bands.

Data band labels may overlap one another if the points they label are close together. In this exercise, you will learn how to stagger a series of labels in a data band, and then move individual data band labels to specific locations.

For more information, see the AutoCAD Civil 3D Help topic *Profile Labels and Label Styles*.

This exercise continues from [Exercise 1: Adding Data Bands to a Profile View](#) (page 331).

Stagger data band labels

- 1 Open *Profile-6B.dwg*, which is located in the [tutorial drawings folder](#) (page 819).
The data bands at the bottom of profile view PV - (3) annotate the horizontal and vertical geometry of the proposed road alignment, and the elevation of each profile at the major stations.
- 2 Zoom in to the following area.

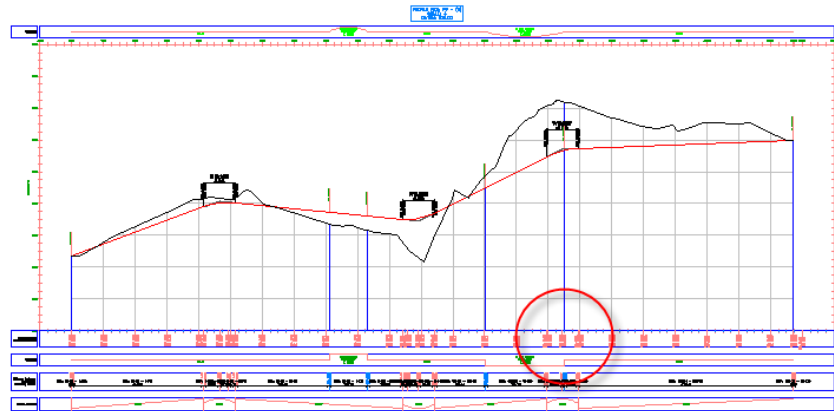

The horizontal and vertical geometry labels overlap in this area.

- 3 Select one of the geometry labels in this band. Right-click. Click Properties.
- 4 In the Properties palette, under Staggering, specify the following parameters:
 - Auto Stagger: Stagger Both Sides
 - Stagger Line Height: 0.0250

The band labels are evenly spaced along the data band, and leader lines are created to the label anchor points.

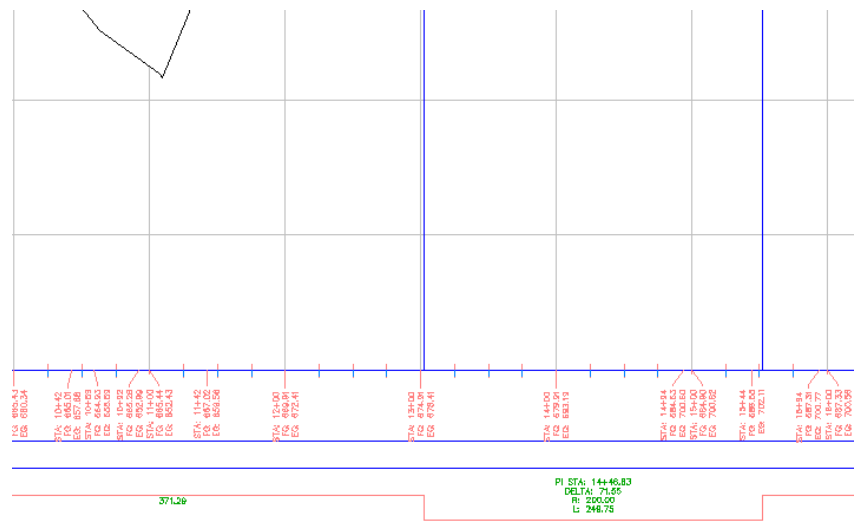

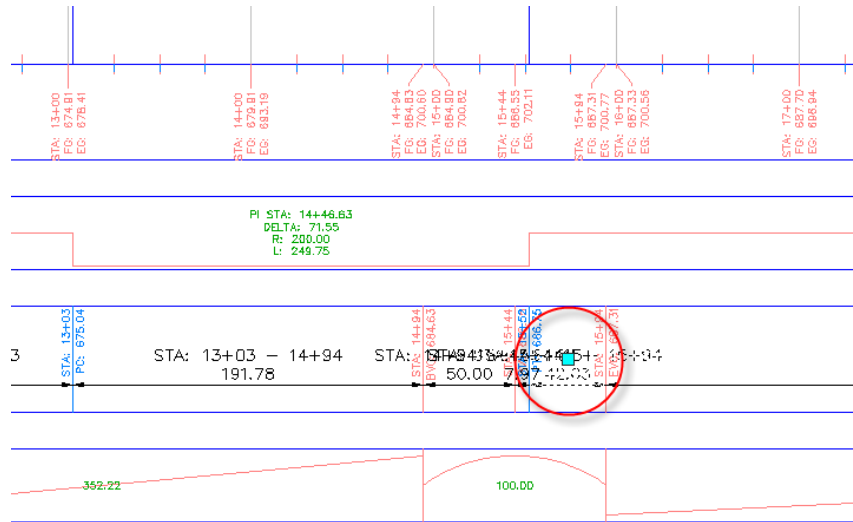

Move data band labels

- 1 In the bottom data band, Ctrl+click the following label.

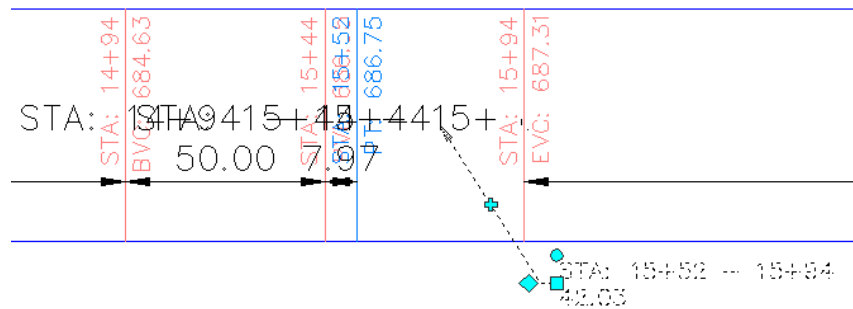

- 2 Drag the grip down and to the right. Click to place the label.



- 3 Click the  grip. Drag the grip to the left. Click to place the grip. A new vertex is added to the label leader line.

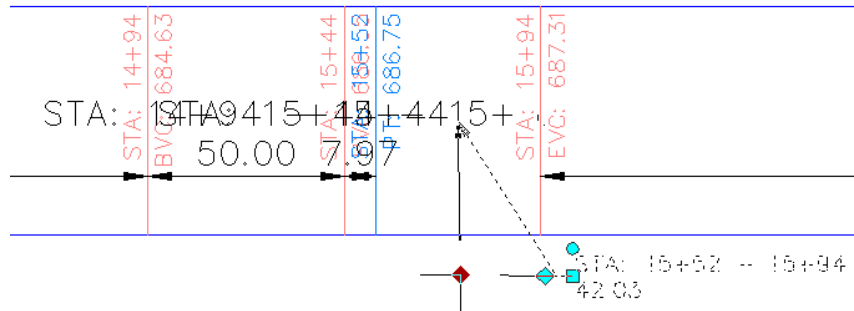

- Repeat Steps 1 through 3 to move the labels that are to the left of the one you just moved.

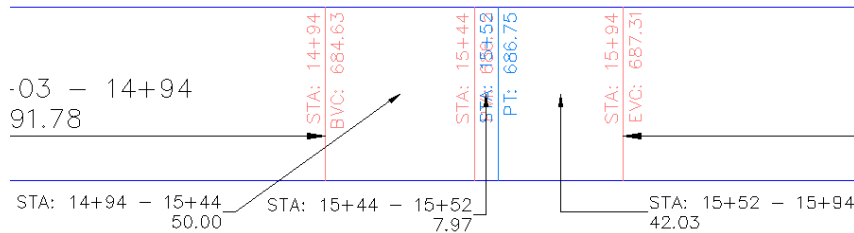

To continue this tutorial, go to [Exercise 3: Modifying a Data Band Style](#) (page 339).

Exercise 3: Modifying a Data Band Style

In this exercise, you will learn how to change the data that is displayed in a data band.

For more information, see the AutoCAD Civil 3D Help topic *Profile Labels and Label Styles*.



This exercise continues from [Exercise 2: Moving Labels in a Data Band](#) (page 336).

Modify the data band style

- Open *Profile-6C.dwg*, which is located in the [tutorial drawings folder](#) (page 819).

Notice that in the bottom, Vertical Geometry band, the labels in the uphill tangents are obscured by the tangents.



- 2 Select the profile grid. Right-click. Click Profile View Properties.
- 3 In the Profile View Properties dialog box, on the Bands tab, in the Location field, select Bottom Of Profile View.
- 4 In the Vertical Geometry row, click  next to Geometry.
- 5 In the Pick Band Style dialog box, click  Edit Current Selection.
- 6 In the Vertical Geometry Band Style dialog box, on the Band Details tab, in the Labels and Ticks area, the At field indicates which type of band labeling has the focus of the editing tools. Make sure that Uphill Tangent is selected.
- 7 In the Labels and Ticks area, click Compose Label.
The Label Style Composer dialog box contains the controls for creating and editing label components. Notice the many controls that are available for band label format.
- 8 In the Text collection, change the Attachment value to Bottom Center.
- 9 Click OK three times.
- 10 In the Profile View Properties dialog box, click Apply.
Notice that in the drawing, the position of the data band's uphill tangent label has changed.



Further exploration: Change the label position for the downhill tangents and sag and crest curves.

Parcels Tutorials

10

These tutorials will get you started creating and editing parcels.

Parcel objects in AutoCAD Civil 3D are typically used to represent real estate parcels, such as lots in a subdivision.

NOTE All drawings used in these tutorials are available in the [tutorial drawings folder](#) (page 819). If you want to save your work from these tutorials, save the drawings to the [My Civil Tutorial Data folder](#) (page 819) so that you do not overwrite the original drawings.

For more information, see the AutoCAD Civil 3D Help topic *Understanding Parcels*.

Tutorial: Creating Parcels

This tutorial demonstrates the main methods for creating parcels.

You can create parcels either from drawing objects, such as lines, arcs, or polylines, or by using the parcel layout tools. Parcels can also be created automatically by the interaction of alignments and other parcels within a site.

Parcels are contained in a parcels collection, which in turn is contained by a site. Each site can include only one parcels collection, but a parcels collection can include any number of parcels.

For more information, see the AutoCAD Civil 3D Help topic *Creating Parcels*.

Exercise 1: Creating Parcels from AutoCAD Objects

In this exercise, you will convert AutoCAD entities to land parcels with automatic labels that show useful topological data, such as land area.

Parcel layout tools are available to create and edit parcels with precision. You will learn more about the Parcel Layout tools in later AutoCAD Civil 3D tutorial exercises.

For more information, see the AutoCAD Civil 3D Help topic *Creating Parcels from Objects*.

Create parcels from existing AutoCAD objects

- 1 Open drawing *Parcel-1A.dwg*, which is located in the [tutorial drawings folder](#) (page 819).
This drawing contains an existing ground surface, alignments that represent intersecting road centerlines, and AutoCAD lines and arcs that represent property boundaries. In the following steps, you will create AutoCAD Civil 3D parcel objects from the existing lines and arcs.
- 2 Click Home tab ► Create Design panel ► Parcel drop-down ► Create Parcel From Object .
- 3 Select the lines and the polyline border at the east side of the site, north of the First Street alignment. Press Enter.

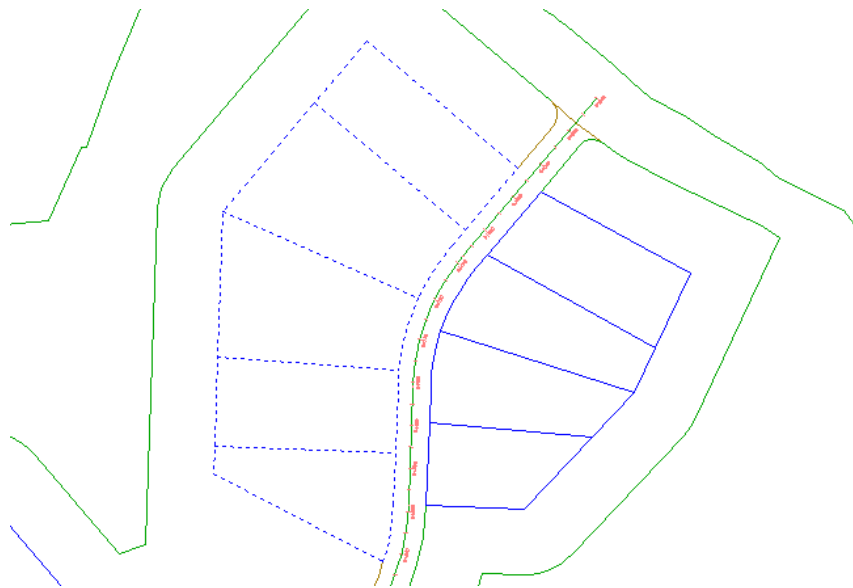

NOTE On the command line, notice that a variety of AutoCAD objects can be used to create parcels.

4 In the Create Parcels – From Objects dialog box, specify the following parameters:

- Site: Site 1
- Parcel Style: Single-Family
- Area Label Style: Parcel Number And Area

NOTE Parcels must have area labels, but segment labels are optional.

- Automatically Add Segment Labels: Selected
- Erase Existing Entities: Selected

5 Click OK.

The parcels are created and labeled. The labels annotate the overall parcel area, as well as the bearing and distance of each line and curve segment. These labels are automatically updated if any line or curve segments are edited or deleted.

The numbers with a circular border are automatically generated parcel numbers. You will change these numbers to use a more desirable numbering convention.

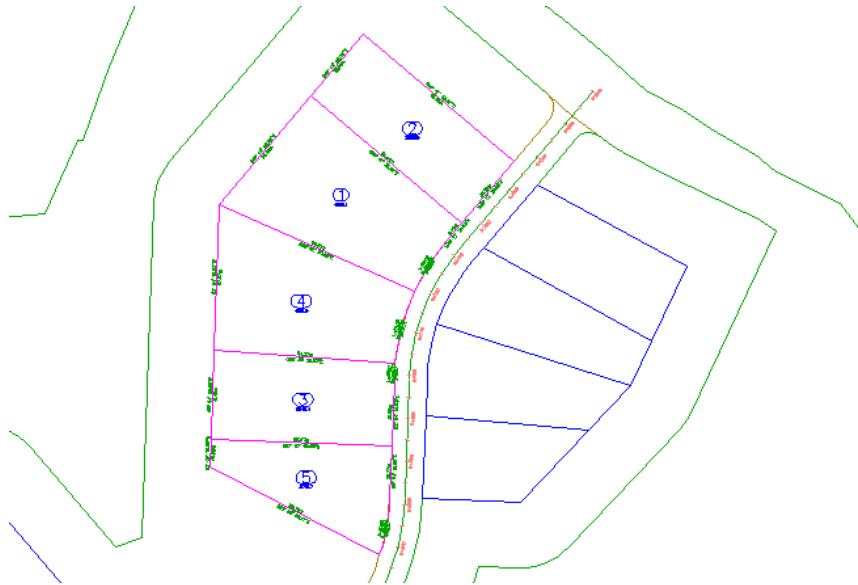

Change the parcel numbering

- 1 Click a parcel number to select it. Click Parcel tab ► Modify panel ► Renumber/Rename .
- 2 In the Renumber/Rename Parcels dialog box, specify the following parameters:
 - Renumber: Selected
 - Starting Number: 101
 - Increment Value: 1
- 3 Click OK.
- 4 To specify a start point, click to top-most parcel.
- 5 To specify an end point, click the bottom-most parcel.

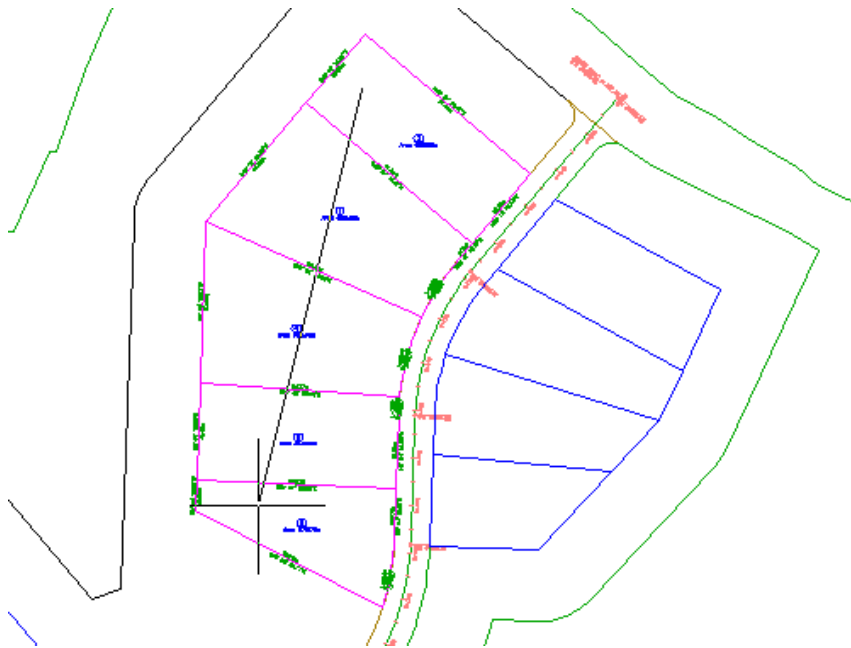

- 6 Press Enter twice.
The parcel area labels are now numbered in ascending order, with three digits.

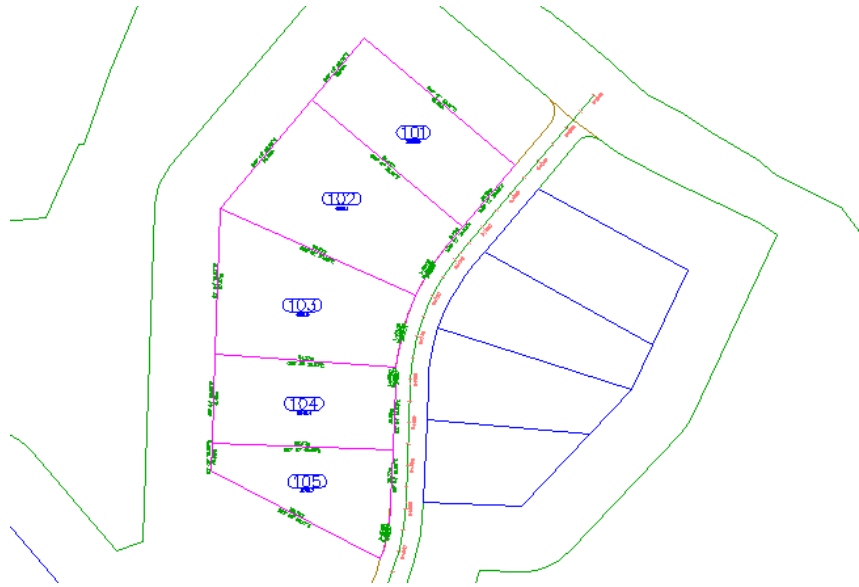

To continue this tutorial, go to [Exercise 2: Subdividing a Parcel with a Free-Form Segment](#) (page 345).

Exercise 2: Subdividing a Parcel with a Free-Form Segment

In this exercise, you will successively subdivide a parcel with segments that can be placed along any lot line.

For more information, see the AutoCAD Civil 3D Help topic *Creating Parcels by Layout*.

This exercise continues from [Exercise 1: Creating Parcels from AutoCAD Objects](#) (page 341).

Create parcels using a free-form line

- 1 Open *Parcel-1B.dwg*, which is available in the [tutorial drawings folder](#) (page 819).
- 2 Click Home tab ► Create Design panel ► Parcel drop-down ► Parcel Creation Tools .

- 3 On the Parcel Layout Tools toolbar, click  Free Form Create.
- 4 In the Create Parcels - Layout dialog box, click OK.
- 5 In the drawing, snap to the endpoint shown in the following image.
Notice that frontage does not need to be specified.

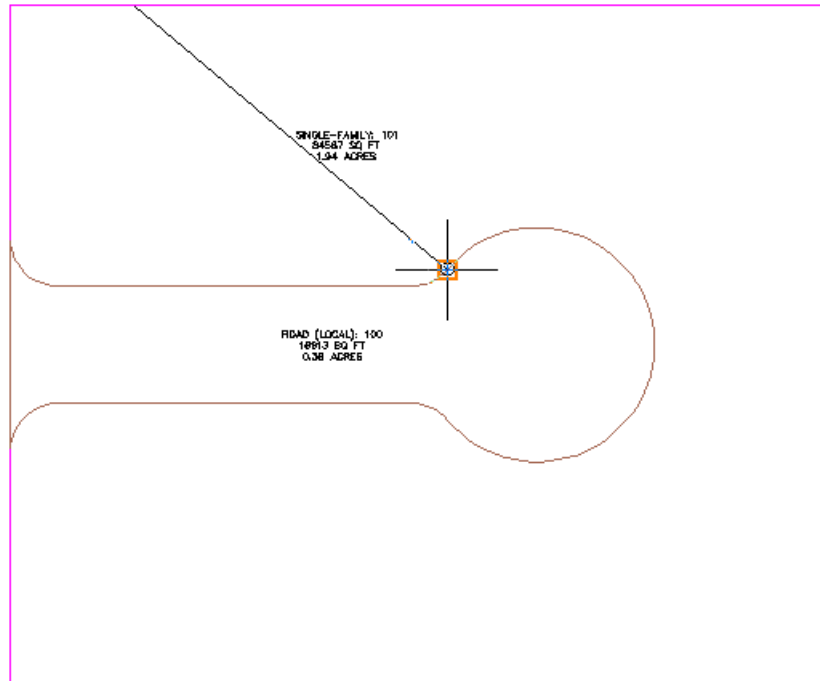

- 6 To specify the lot line direction, move the cursor straight up, and snap to the intersection of the back lot line.

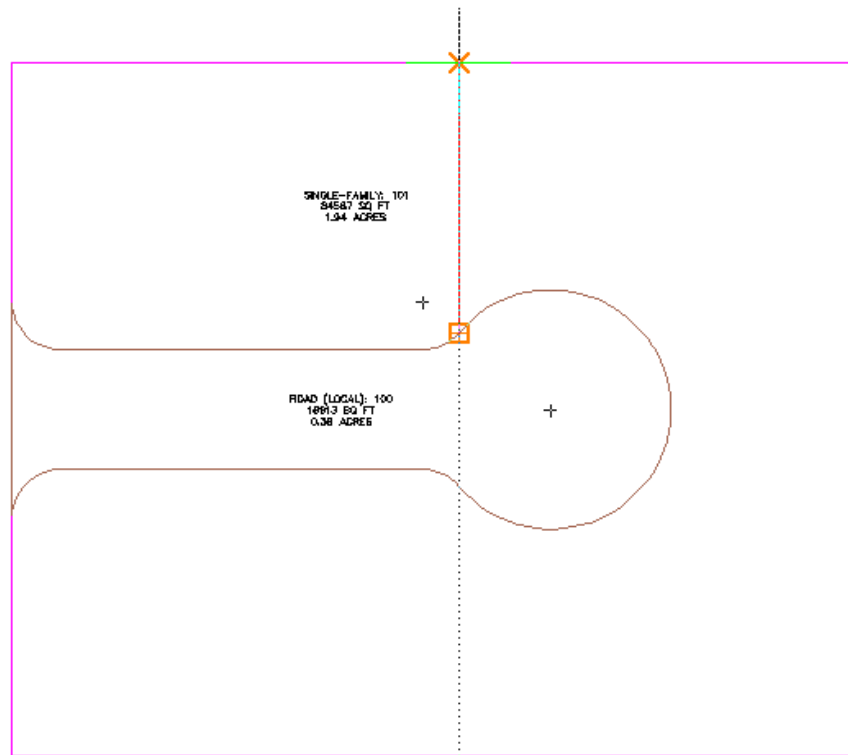

The new parcel is created and labeled.

- 7 Repeat Steps 5 and 6 to create another lot line as shown in the following image.

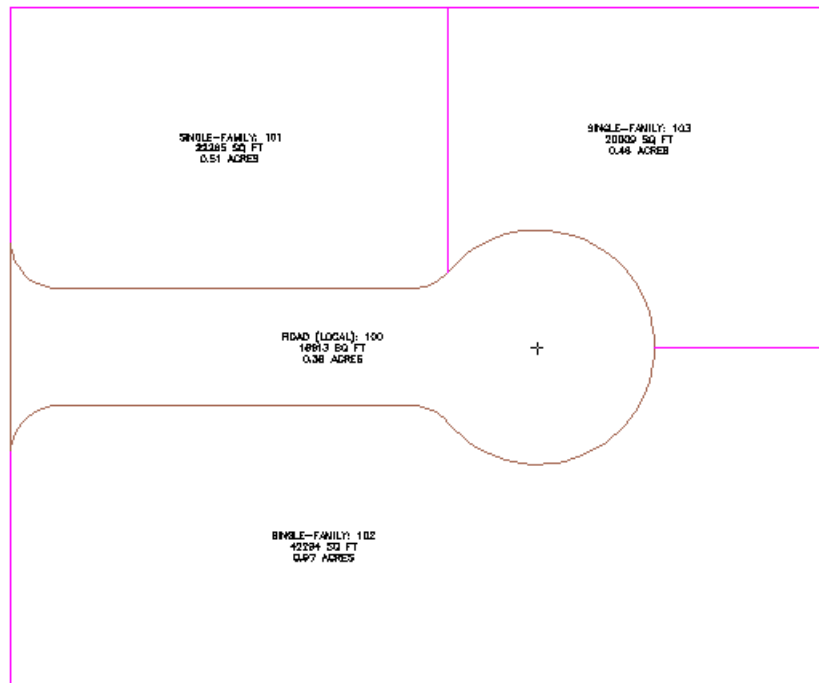

8 Press Esc to end the command.

To continue this tutorial, go to [Exercise 3: Subdividing a Parcel with a Slide Line](#) (page 348).



Exercise 3: Subdividing a Parcel with a Slide Line

In this exercise, you will successively subdivide a parcel with segments that are defined by their angle at the frontage.

For more information, see the AutoCAD Civil 3D Help topic *Creating Parcels by Layout*.

This exercise continues from [Exercise 2: Subdividing a Parcel with a Free-Form Segment](#) (page 345).

Specify parcel creation settings

- 1 Open *Parcel-1C.dwg*, which is available in the [tutorial drawings folder](#) (page 819).
- 2 Click Home tab ► Create Design panel ► Parcel drop-down ► Parcel Creation Tools .
- 3 On the Parcel Layout Tools toolbar, click .
- 4 Specify the following parameters:
As you specify each parameter, notice that a preview graphic is displayed at the bottom of the Parcel Layout Tools window.

Parcel Sizing

- Minimum Area: 7000.00
- Minimum Frontage: 40.0000
- Use Minimum Frontage At Offset: Yes
- Frontage Offset: 20.0000
- Minimum Width: 40.0000
- Minimum Depth: 50.0000
- Use Maximum Depth: Yes
- Maximum Depth: 200.0000
- Multiple Solution Preference: Use Smallest Area

Automatic Layout

- Automatic Mode: Off
- Remainder Distribution: Place Remainder In Last Parcel

NOTE When Automatic Mode is set to Off, the Remainder Distribution setting does not affect parcel layout. This setting will be used in later exercises.

Create individual parcels using a slide line

- 1 In the Parcel Layout Tools toolbar, click  Slide Line – Create.
- 2 In the Create Parcels – Layout dialog box, for Parcel Style, select Single-Family. Leave other settings at their default values. Click OK.
- 3 Click the area label for parcel Single-Family: 101.
- 4 Specify the start and end points of the parcel frontage as shown in the following image.

Notice that when you move the cursor to specify the end point, a yellow line displays the proposed frontage.

NOTE When you specify the frontage starting point, do not snap to the beginning of the curve. If the frontage starts at the beginning point of the curve, no solution will be found.

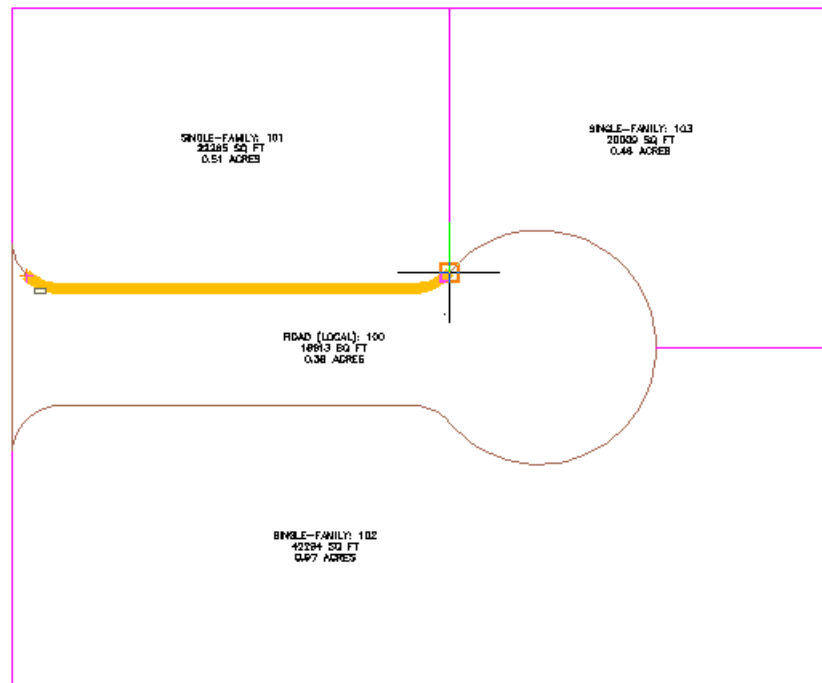

- 5 Enter a frontage angle of 90 degrees.

Preview graphics of the parcel creation parameters and proposed solution are displayed. The graphics are similar to those that were displayed while you were specifying parcel creation parameters in the Parcel Layout Tools window.

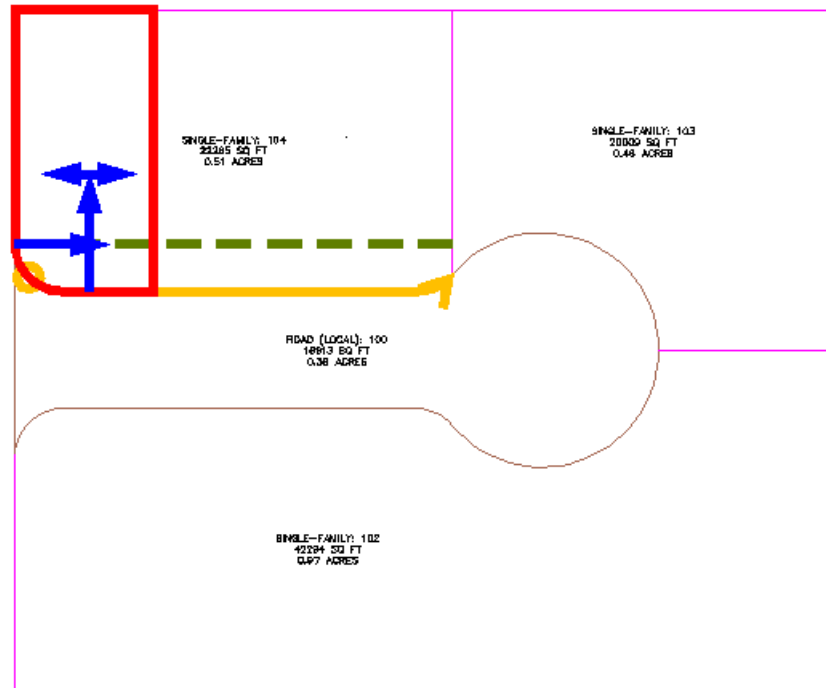

- 6 Press Enter.
The new parcel is created and labeled, and a preview of the next parcel is displayed in the drawing.
- 7 In the Parcel Layout Tools dialog box, for Minimum Area, enter 8000.
Notice that the preview graphic updates to reflect the changed area value.
- 8 Press Enter.
Two new parcels are created and labeled.

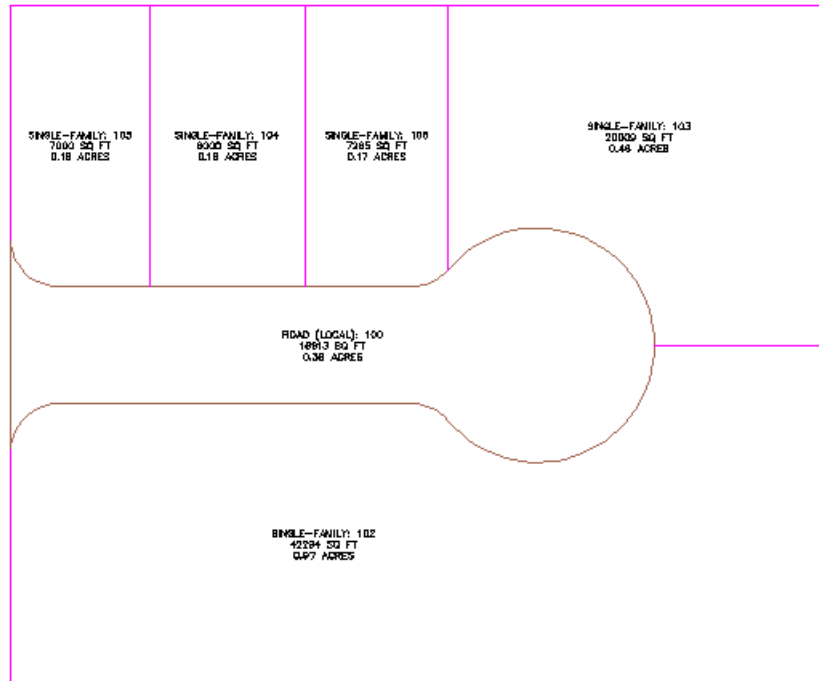

Create multiple parcels simultaneously

- 1 In the Parcel Layout Tools toolbar, click  Slide Line – Create.
- 2 Under Automatic Layout, specify the following parameters:
 - Automatic Mode: On
 - Remainder Distribution: Place Remainder In Last Parcel
- 3 Click the area label for the large parcel on the south side of the site.
- 4 Specify the start and end points of the parcel frontage as shown in the following image.

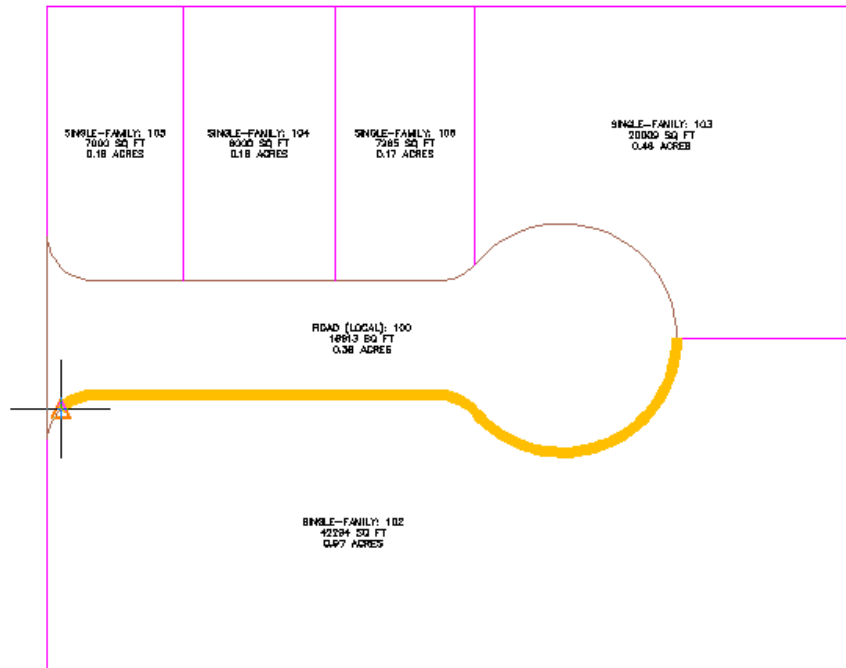

- 5 Enter a frontage angle of 90 degrees.
A preview of the proposed parcels is displayed.

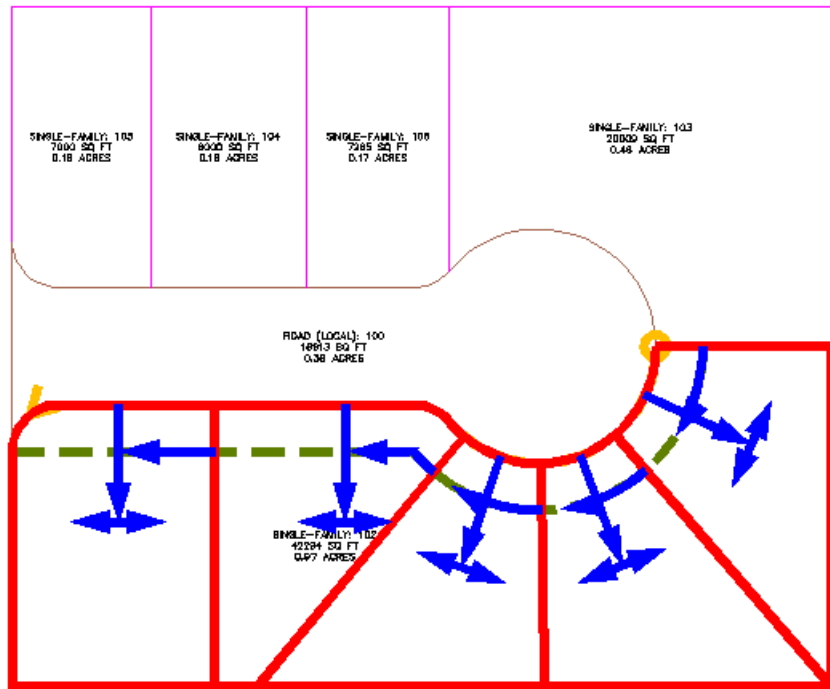

- 6 Press Enter.
The new parcels are created and labeled.

NOTE You will correct the placement of some of the lot lines in the [Editing Parcel Data](#) (page 361) tutorial.

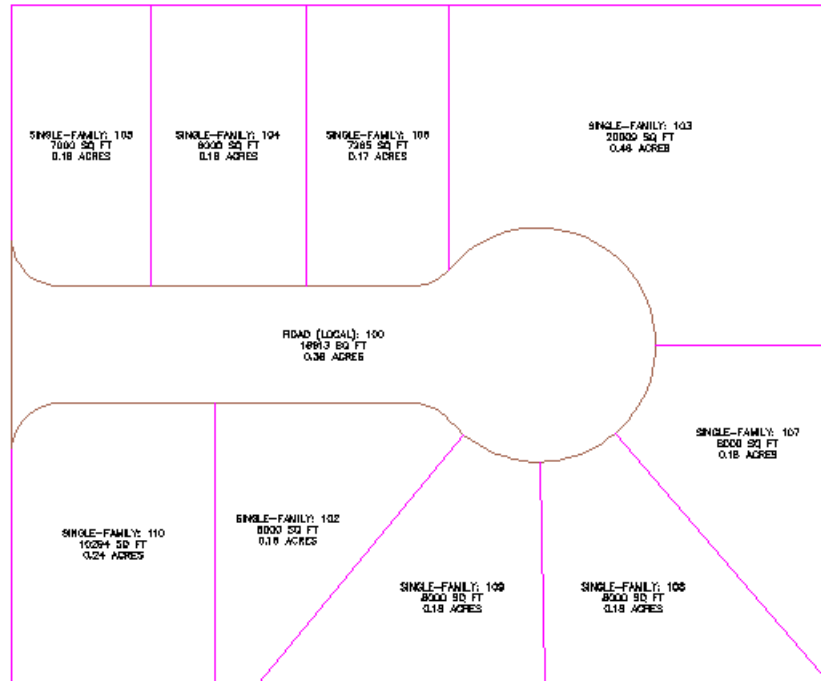

7 Press Esc to end the command.

To continue this tutorial, go to [Exercise 4: Subdividing a Parcel with a Swing Line](#) (page 355).



Exercise 4: Subdividing a Parcel with a Swing Line

In this exercise, you will subdivide a parcel with a segment that swings from a reference point on the back line.

For more information, see the AutoCAD Civil 3D Help topic *Creating Parcels by Layout*.

This exercise continues from [Exercise 3: Subdividing a Parcel with a Slide Line](#) (page 348).

Specify parcel creation settings

- 1 Open *Parcel-1D.dwg*, which is available in the [tutorial drawings folder](#) (page 819).
- 2 Click Home tab ► Create Design panel ► Parcel drop-down ► Parcel Creation Tools .
- 3 On the Parcel Layout Tools toolbar, click .
- 4 Specify the following parameters:
As you specify each parameter, notice that a preview graphic is displayed at the bottom of the Parcel Layout Tools window.

Parcel Sizing

- Minimum Area: 8000.00
- Minimum Frontage: 40.0000
- Use Minimum Frontage At Offset: Yes
- Frontage Offset: 20.0000
- Minimum Width: 40.0000
- Minimum Depth: 50.0000
- Use Maximum Depth: Yes
- Maximum Depth: 200.0000
- Multiple Solution Preference: Use Smallest Area

Automatic Layout

- Automatic Mode: Off
- Remainder Distribution: Place Remainder In Last Parcel

Create parcels using a swing line

- 1 On the Parcel Layout Tools toolbar, click  Swing Line – Create.
- 2 In the Create Parcels – Layout dialog box, for Parcel Style, select Single-Family. Leave other settings at their default values. Click OK.

- 3 In the drawing, select the area label of the large parcel in the northeast corner of the site.
- 4 Specify the start and end points of the parcel frontage as shown in the following image.

Notice that when you move the cursor to specify the end point, a yellow line displays the proposed frontage.

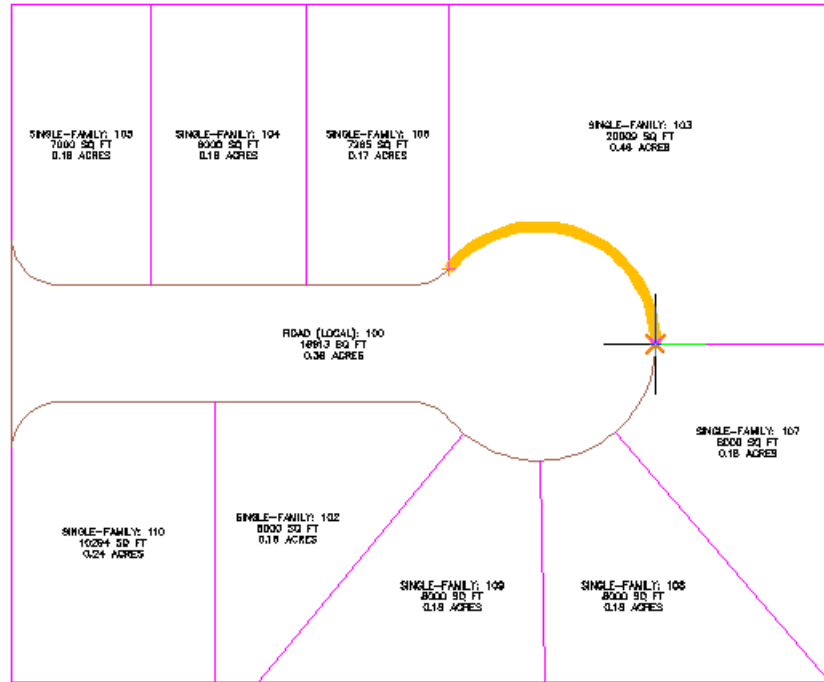

- 5 Click the northeast corner of the parcel to specify the swing point. A preview graphic is displayed.

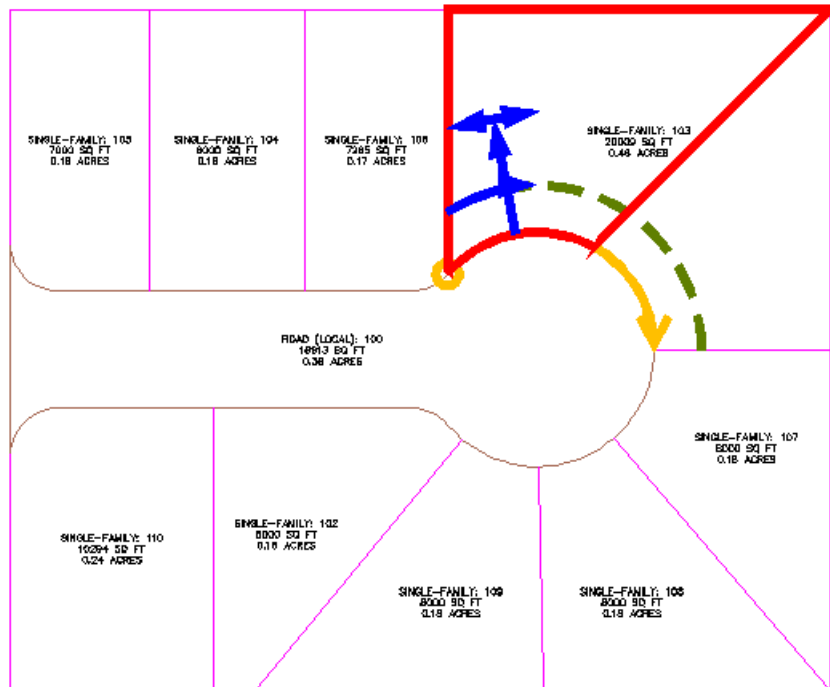

- 6 Press Enter to create the parcel.
The new parcel is created and labeled.

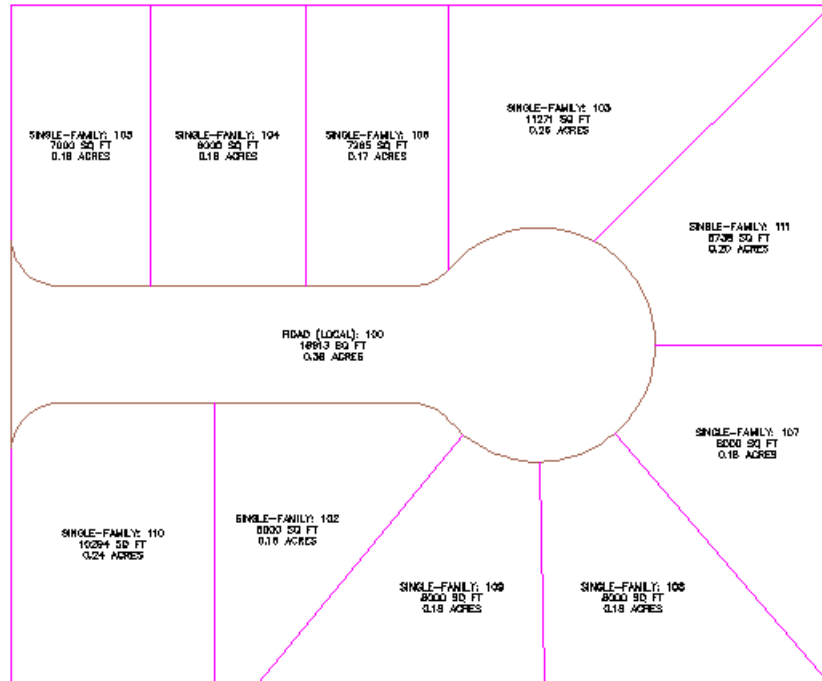

7 Press Esc to end the command.

To continue this tutorial, go to [Exercise 5: Working with Alignments and Parcels](#) (page 359).

Exercise 5: Working with Alignments and Parcels

In this exercise, you will create an alignment outside of a site and move existing alignments out of sites. These practices eliminate unwanted parcels being created by alignments interacting with a site.

When an alignment is in a site, it creates new parcels if it forms closed areas by crossing over itself or other alignments or parcels on the same site.

For more information, see the AutoCAD Civil 3D Help topic *Understanding Sites*.

Examine alignments in a site

- 1 Open *Parcel-1E.dwg*, which is located in the [tutorial drawings folder](#) (page 819).

This drawing contains five roads off of a main West-East road. The two Northern side roads have centerline alignments, each of which created a parcel in the roadway and cul-de-sac center island. In the next few steps, you will convert the centerline of one of the Southern side roads to an alignment and prevent it from forming parcels.

- 2 In Toolspace, on the Prospector tab, expand Sites ► Site 1 ► Alignments ► Centerline Alignments.

Notice that the four existing centerline alignments all reside in Site 1, while the top-level Alignments collection (above the Sites collection) is empty.

Create an alignment outside of a site

- 1 Click Home tab ► Create Design panel ► Alignment drop-down ► Create Alignment From Objects .

- 2 When prompted, select the red centerline for the road in the lower middle of the drawing.

- 3 Press Enter twice.

The Create Alignment from Objects dialog box is displayed. Notice that, by default, the Site is set to <None>.

- 4 Click OK.

- 5 Expand the top-level Alignments ► Centerline Alignments collection in Prospector.

Notice that the new alignment was placed in the Alignments collection, and did not form a parcel in the cul-de-sac center island. This happened because you accepted the default <None> Site selection when you were prompted to select a site in step 3. In the next few steps, you will move one of the two existing cul-de-sac road alignments out of its existing site and into the top-level Alignments collection.

Move alignments out of a site

- 1 In Toolspace, on the Prospector tab, right-click Alignment - (4), which is the cul-de-sac alignment to the Northeast of the alignment you created. Click Move To Site.

- 2 In the Move To Site dialog box, make sure that the Destination Site is set to <None>.
- 3 Click OK.

Notice that in Toolspace on the Prospector tab, Alignment - (4) has moved to the top-level Alignments collection. In the drawing window, the parcel label and hatching has been removed from the cul-de-sac center island.

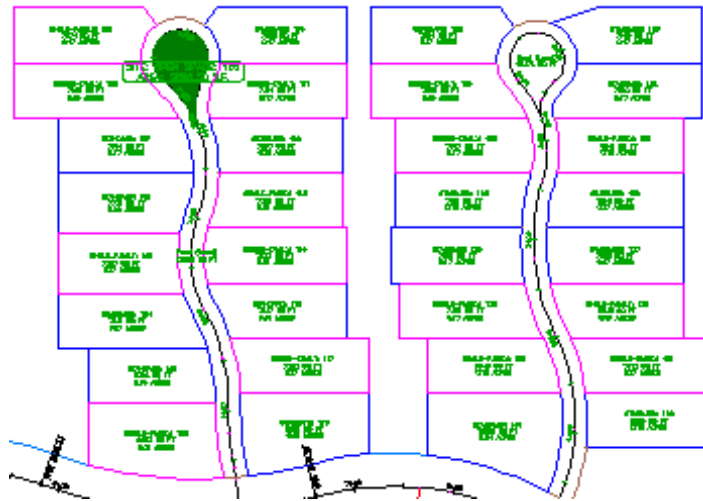

Further Exploration: Repeat the preceding steps to move Alignment - (3) to the top-level Alignments collection.

- 4 Close *Parcel-1E.dwg*.

To continue to the next tutorial, go to [Editing Parcel Data](#) (page 361).

Tutorial: Editing Parcel Data

This tutorial demonstrates two ways of resizing a parcel by moving a lot line.

The tools that you use to edit a parcel lot line depends on whether the lot line is attached.

An attached lot line is a parcel segment that was created with the slide angle, slide direction, and swing line precise sizing tools on the Parcel Layout Tools toolbar. You can use the slide angle, slide direction, and swing line precise

editing tools to edit only attached lot lines. In this tutorial, you will learn how to use two precise editing tools:

- The *Slide Angle – Edit* tool slides a lot line at a specified angle through a selected parcel until a target area is enclosed.
- The *Swing Line – Edit* tool swings a lot line from a specified point through a selected parcel until a target area is enclosed.

If a lot line is created either from other AutoCAD Civil 3D objects or the fixed line and curve tools on the Parcel Layout Tools toolbar, it is not attached. You can use grips and the feature line editing tools to change the geometry of these lot lines.



For more information, see the AutoCAD Civil 3D Help topic *Editing Parcels*.

Exercise 1: Sliding a Parcel Lot Line

In this exercise, you will resize a parcel by sliding an attached lot line along the parcel frontage.

For more information, see the AutoCAD Civil 3D Help topic *Editing Parcels by Layout*.

Specify parcel creation settings

- 1 Open *Parcel-2A.dwg*, which is located in the [tutorial drawings folder](#) (page 819).
- 2 Click Home tab ► Create Design panel ► Parcel drop-down ► Parcel Creation Tools .
- 3 On the Parcel Layout Tools toolbar, click .
- 4 Specify the following parameters:
As you specify each parameter, notice that a preview graphic is displayed at the bottom of the Parcel Layout Tools window.

Parcel Sizing

- Minimum Area: 8000.00
- Minimum Frontage: 40.0000
- Use Minimum Frontage At Offset: Yes

- Frontage Offset: 20.0000
- Minimum Width: 40.0000
- Minimum Depth: 50.0000
- Use Maximum Depth: Yes
- Maximum Depth: 200.0000
- Multiple Solution Preference: Use Smallest Area

Automatic Layout

- Automatic Mode: Off
- Remainder Distribution: Place Remainder In Last Parcel

Slide a parcel lot line

- 1 In the Parcel Layout Tools toolbar, click  Slide Line - Edit.
- 2 In the Create Parcels – Layout dialog box, click OK.
You are prompted to select the attached lot line to adjust.

NOTE An attached lot line is one that was created with the slide angle, slide direction, and swing line precise sizing tools available on the Parcel Layout Tools toolbar. You can use the slide line edit command to edit only attached lot lines. You will learn how to edit lot lines created using other methods in [Exercise 3: Editing Parcel Lot Line Geometry](#) (page 375).

- 3 In the drawing, click the lot line that is between parcel 108 and parcel 109.
- 4 Select the parcel to adjust by moving the cursor over property 109. The parcel borders are highlighted. Click inside the parcel.

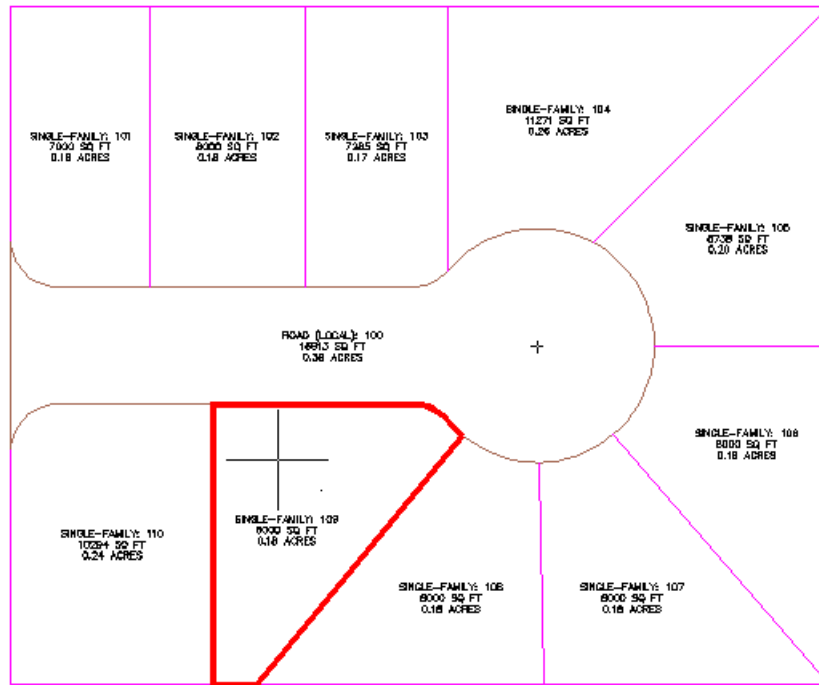

5 Specify the parcel frontage as shown in the following image.

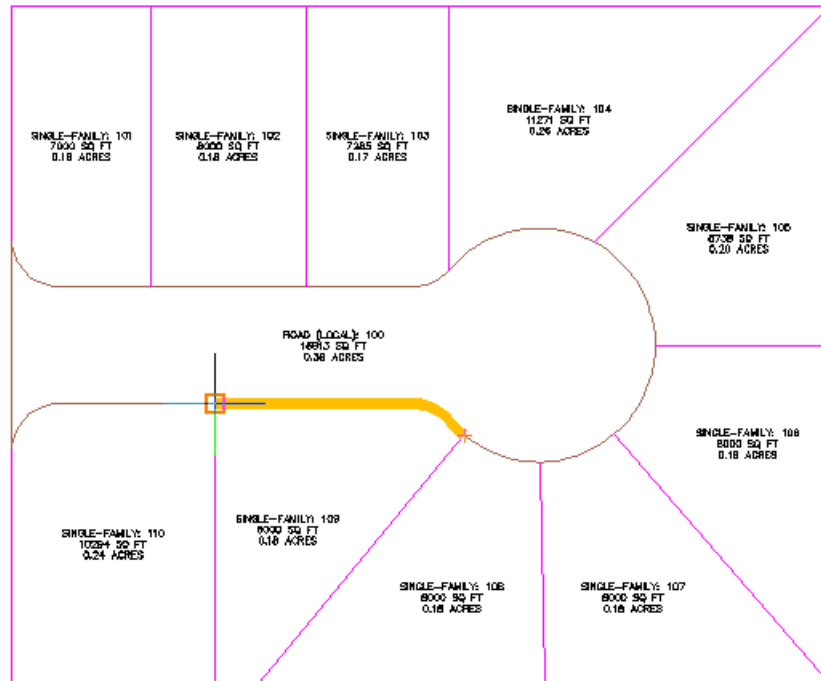

6 Enter a frontage angle of 90.

Preview graphics of the parcel creation parameters and proposed solution are displayed. The displayed solution slides the lot line along the frontage at the angle specified. The proposed solution encloses an area that meets the parcel creation parameters you specified at the beginning of this exercise.

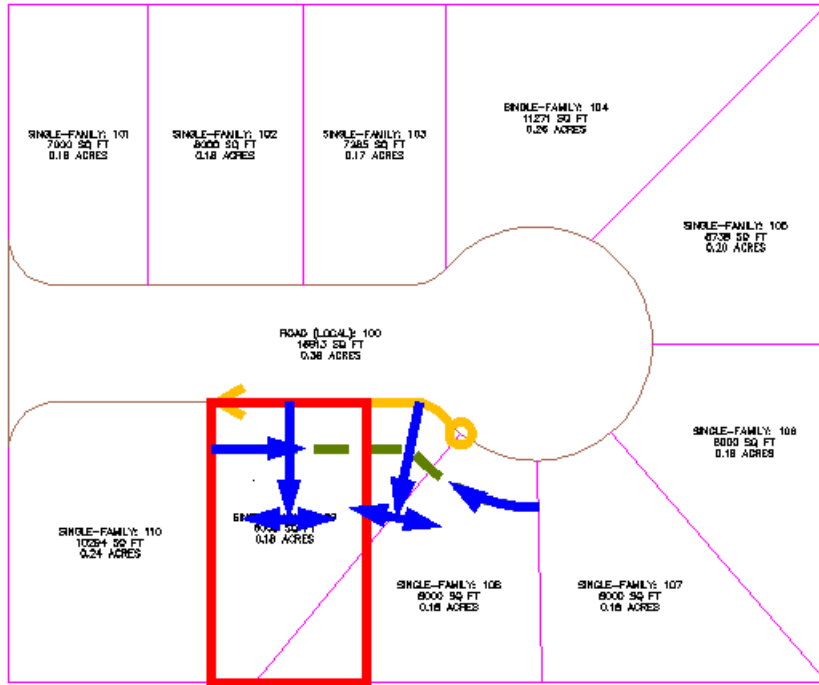

7 Press Enter.

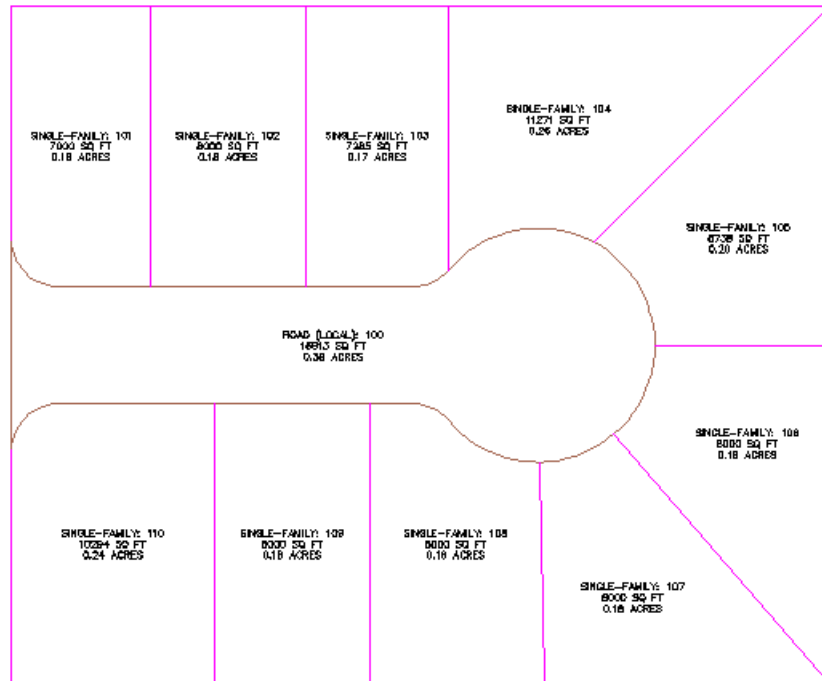

Further exploration: Use Steps 3 through 8 to move the lot lines that are between parcels 108, 109, and 110 to match the parcel layout of parcels 101, 102, and 103.

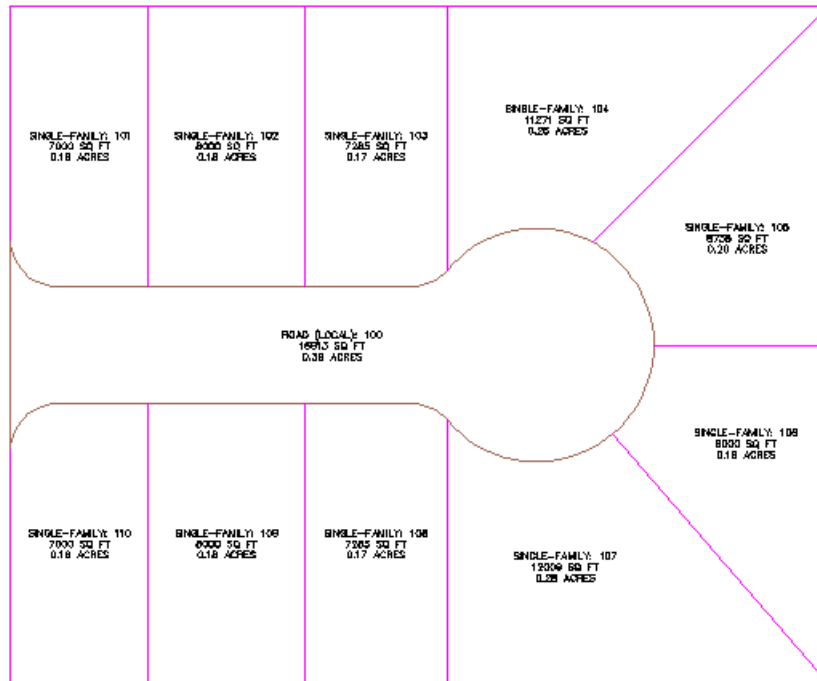

8 Press Esc to end the command.

To continue this tutorial, go to [Exercise 2: Swinging One End of a Parcel Lot Line](#) (page 368).

Exercise 2: Swinging One End of a Parcel Lot Line



In this exercise, you will resize a parcel by swinging an attached lot line from a specified reference point.

For more information, see the AutoCAD Civil 3D Help topic *Editing Parcels by Layout*.

This exercise continues from [Exercise 1: Sliding a Parcel Lot Line](#) (page 362).

Specify parcel creation settings

- 1 Open *Parcel-2B.dwg*, which is located in the [tutorial drawings folder](#) (page 819).

- 2 Click Home tab ► Create Design panel ► Parcel drop-down ► Parcel Creation Tools .
- 3 On the Parcel Layout Tools toolbar, click .
- 4 Specify the following parameters:
As you specify each parameter, notice that a preview graphic is displayed at the bottom of the Parcel Layout Tools window.

Parcel Sizing

- Minimum Area: 8000.00
- Minimum Frontage: 40.0000
- Use Minimum Frontage At Offset: No
- Frontage Offset: 20.0000
- Minimum Width: 40.0000
- Minimum Depth: 50.0000
- Use Maximum Depth: Yes
- Maximum Depth: 200.0000
- Multiple Solution Preference: Use Shortest Frontage

Automatic Layout

- Automatic Mode: Off
- Remainder Distribution: Place Remainder In Last Parcel

Swing one end of a parcel lot line

- 1 On the Parcel Layout Tools toolbar, click  Swing Line – Edit.
- 2 In the Create Parcels – Layout dialog box, click OK.
You are prompted to select the attached lot line to adjust.
- 3 In the drawing, click the lot line that is between parcel 104 and parcel 105.
- 4 Select the parcel to adjust by moving the cursor over property 104 and clicking. Notice that the parcel borders are highlighted.

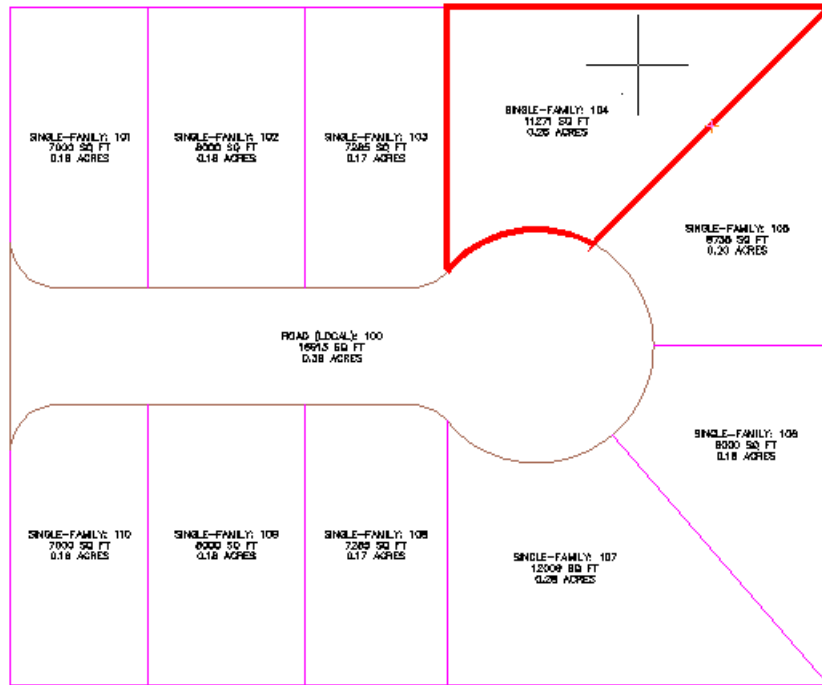

5 Specify the parcel frontage as shown in the following image.

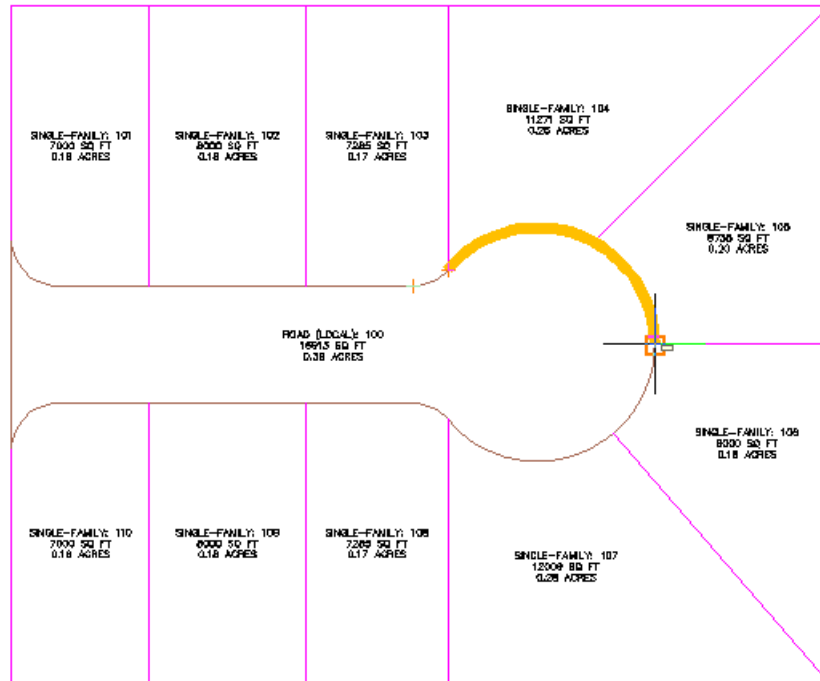

NOTE You must turn off OSNAP to perform the following step.

- 6 Move the cursor to the approximate location in the following image.

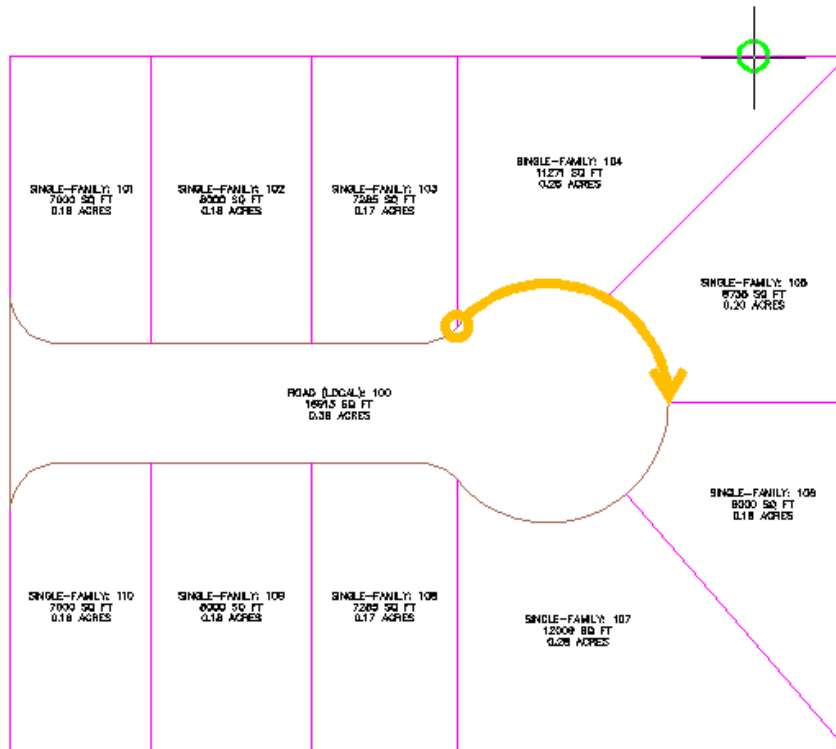

7 Click to place the reference point.

Preview graphics of the parcel creation parameters and proposed solution are displayed. The displayed solution swings the lot line along the reference point. The proposed solution encloses an area that meets the parcel creation parameters you specified at the beginning of this exercise.

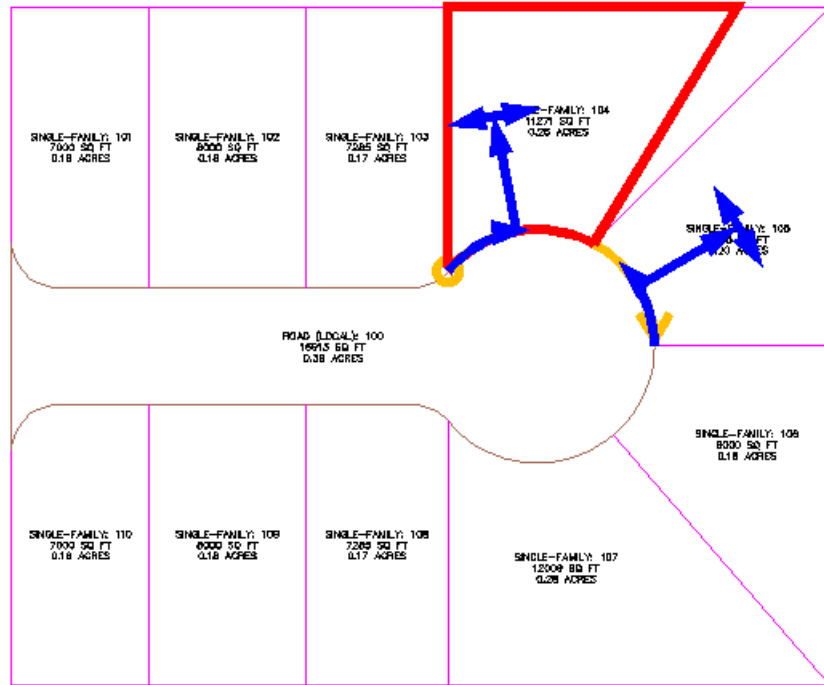

8 Press Enter.

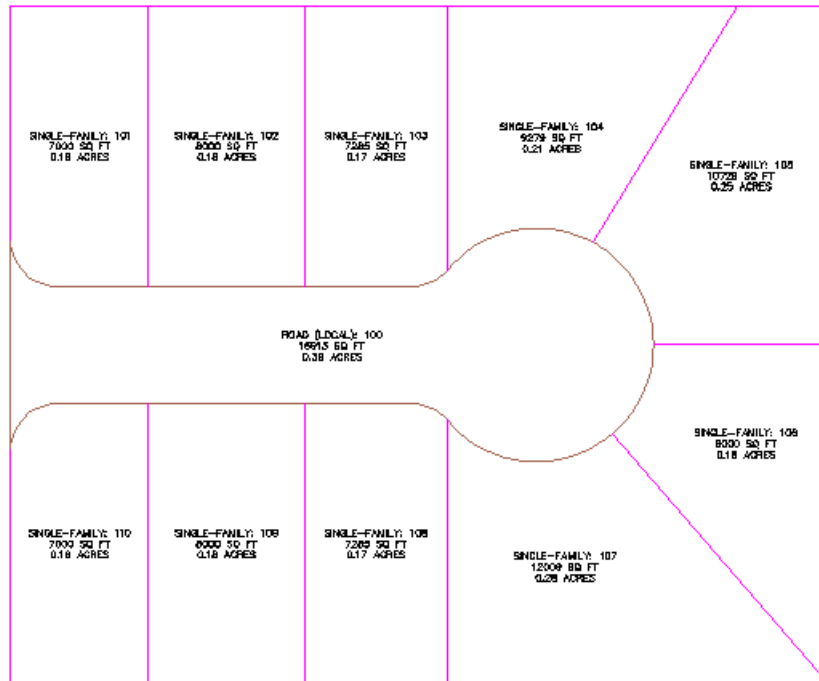

Further exploration: Use Steps 3 through 8 to move the lot line that is between parcels 106 and 107.

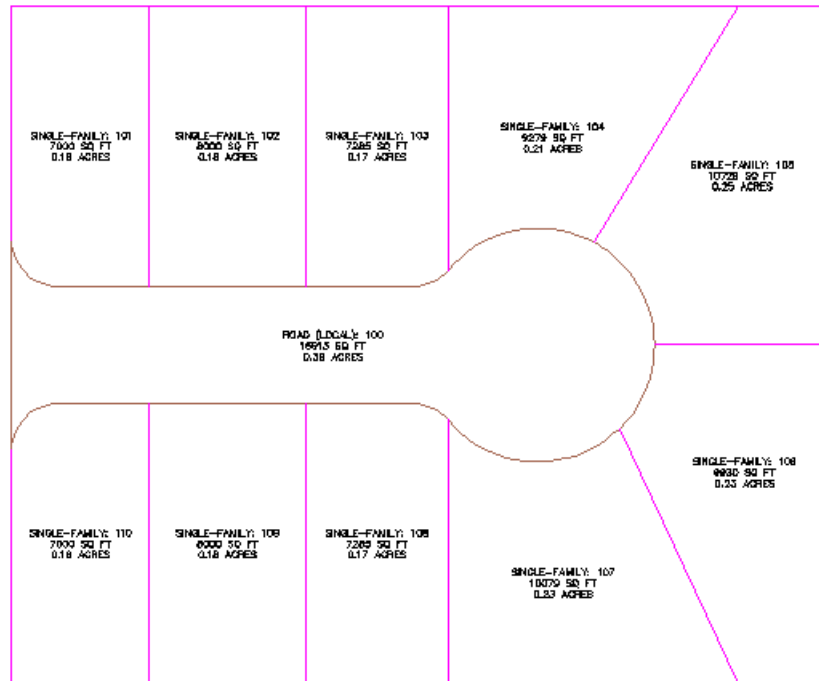

9 Press Esc to end the command.

To continue this tutorial, go to [Exercise 3: Editing Parcel Lot Line Geometry](#) (page 375).

Exercise 3: Editing Parcel Lot Line Geometry

In this exercise, you will use the feature line editing tools to modify parcel lot line geometry.

You will use two different methods to change the geometry of the two large parcels at the end of the cul-de-sac.



First, you will learn about the grips that are available on lot lines. You will use lot line grips with the feature line tools to change the geometry of a parcel.

Second, you will join two separate lot lines, and then remove a point of intersection from the combined lot line.

For more information, see the AutoCAD Civil 3D Help topic *Editing Parcels*.

This exercise continues from [Exercise 2: Swinging One End of a Parcel Lot Line](#) (page 368).

Add a point of intersection to a parcel lot line

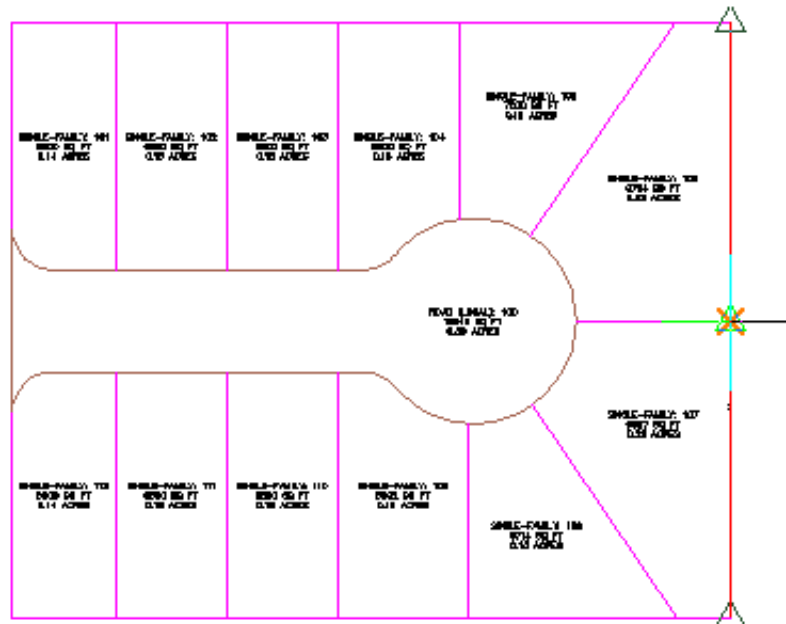

- 1 Open *Parcel-2C.dwg*, which is located in the [tutorial drawings folder](#) (page 819).
- 2 Select the back lot line that is shared by parcels 105 and 106.
- 3 Click Parcel Segment tab ► Modify panel ►  Edit Geometry.
The Edit Geometry panel is displayed in the ribbon.
- 4 Click Parcel Segment tab ► Edit Geometry panel ►  Insert PI.
- 5 Snap to the intersection of the back lot line and the lot line that separates parcels 105 and 106. Click to insert a point of intersection.



- 6 Press Enter to accept the default elevation of 0.
- 7 Press Esc twice to end the command.

The back lot line now has a point of intersection at the point at which the parcels meet. With a PI in this location, you can edit the lot line on one of the parcels without affecting the other.

Grip edit a parcel lot line

- 1 In the drawing, select the lot line that separates parcel 104 and 105.
Notice the  grip on the lot line. This grip is available on attached lot lines, which are created with the slide angle, slide direction, and swing line precise sizing tools available on the Parcel Layout Tools toolbar. You can use this grip to slide the lot line along the lot line to which it is attached.
- 2 Press Esc to deselect the lot line.
- 3 Select the back lot line that is shared by parcels 105 and 106.
Notice the  grips on the ends of the lot line. These grips are available on lot lines that were created either from other AutoCAD Civil 3D objects or the fixed line and curve tools available on the Parcel Layout Tools toolbar. You can use these grips to change the endpoint location of a lot line.
- 4 Click the grip at the top of the lot line. Drag the grip toward the lot line that separates parcels 104 and 105. Snap to the intersection of the three lot lines. Click to place the grip.

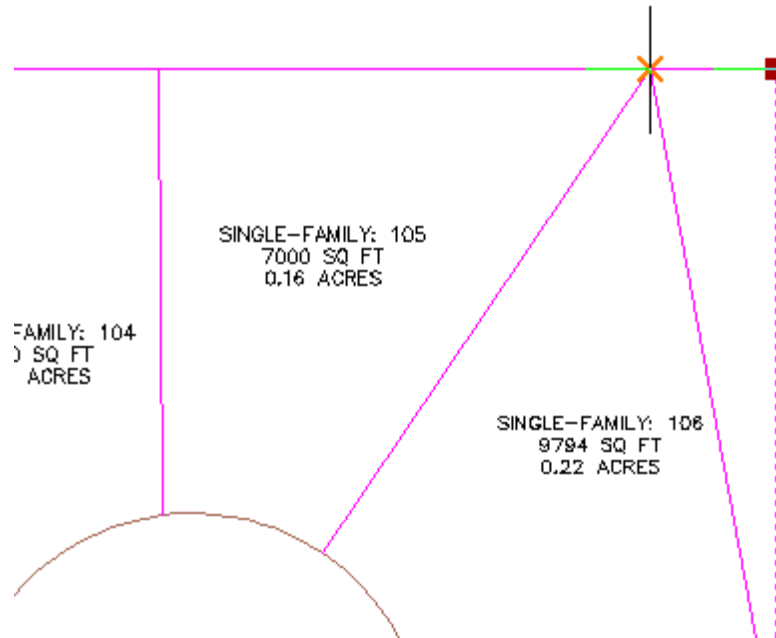

Notice that the area of parcel 105 has changed. However, there is now an unnecessary lot line remaining to the North of the parcel. You will delete the unnecessary portion of that lot line in the following steps.

Trim an extraneous parcel lot line

- 1 Click Parcel Segment tab ► Edit Geometry panel ►  Trim.
- 2 Select the back lot line of parcel 105 as the cutting edge. Press Enter.
- 3 Select the lot line that extends past parcel 105 as the object to trim.

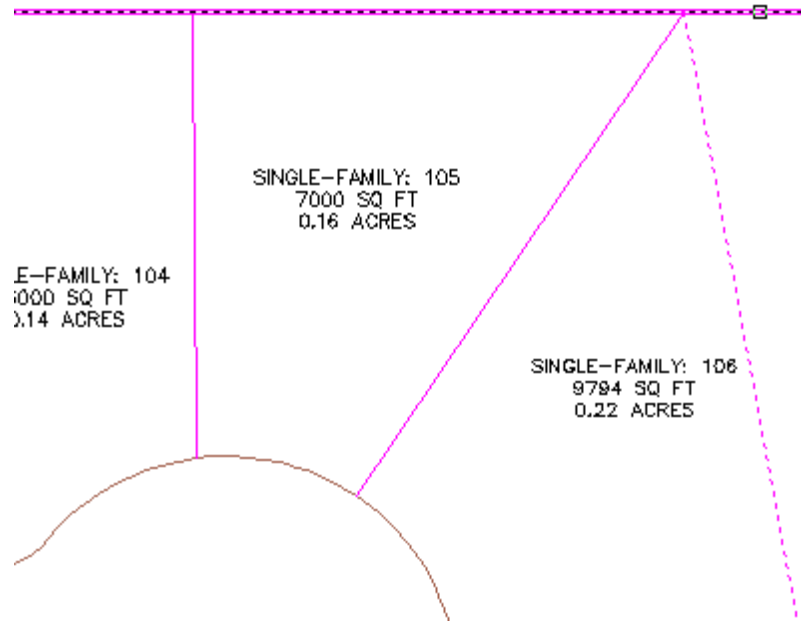

- 4 Press Enter to end the command.

Break a parcel lot line

- 1 Click Parcel Segment tab ► Edit Geometry panel ►  Break.
- 2 Select the back lot line that is shared by parcels 106 through 110.
- 3 On the command line, enter F to specify the first point to break.
- 4 In the drawing, snap to the intersection of the back lot line and the lot line that separates parcels 107 and 108. Click the intersection.

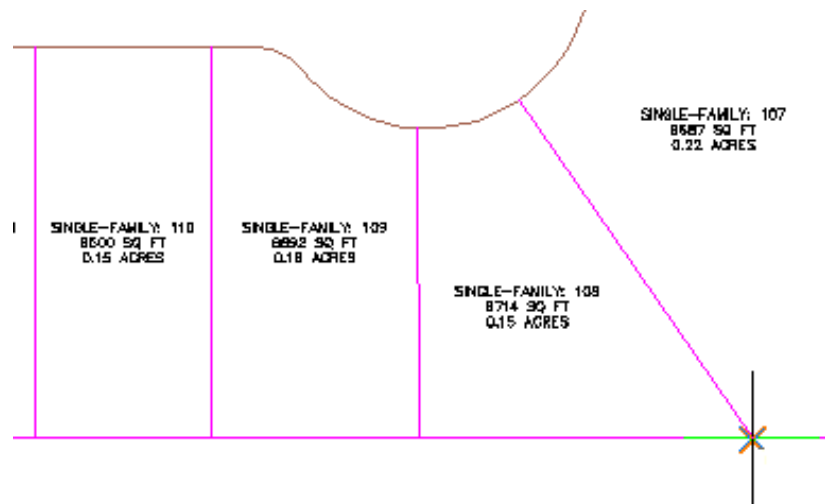

- 5 Press Enter.
Two lot lines are created, separated at the point you specified.

Join two parcel lot lines

- 1 Click Parcel Segment tab ► Edit Geometry panel ►  Join.
- 2 In the drawing, click the two lot lines that form the southeast corner of parcel 106.
- 3 Press Enter.
The two lot lines are now a single entity.

Delete a point of intersection

- 1 Click Parcel Segment tab ► Edit Geometry panel ►  Delete PI.
- 2 In the drawing, select the lot line that forms the south and east boundaries of the parcel.
- 3 Click the green PI at the southeast corner of parcel 108.

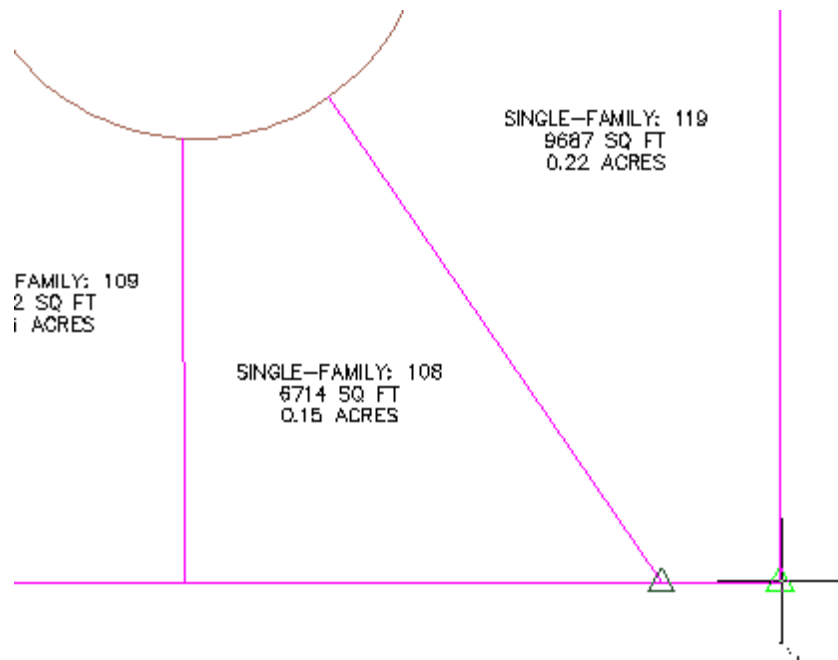

4 Press Enter twice to end the command.

To continue to the next tutorial, go to [Displaying and Analyzing Parcels](#) (page 381).

Tutorial: Displaying and Analyzing Parcels

This tutorial demonstrates using parcel styles and display order to control the appearance of parcels, and exporting reports to analyze parcel data.

The parcel *display order*, which is set in the Site Parcel Properties dialog box, controls the display of shared parcel segments. The different styles of parcels in a drawing are drawn in a specified order that you can control. Where two styles of parcels share a common segment, the displayed color of the segment is determined by the parcel style that is drawn last.

AutoCAD Civil 3D allows you to export inverse or map check reports for either a single parcel, a series of parcels, or all parcels in a site.

For more information, see the AutoCAD Civil 3D Help topics *Parcel Styles*, *Parcel Properties*, and *Exporting a Parcel Inverse or Mapcheck Report*.

For a tutorial on using the AutoCAD Civil 3D survey tools to perform a mapcheck analysis, see the [Outputting Survey Information](#) (page 171).

Exercise 1: Changing Parcel Style Display Order

In this exercise, you will control the display of overlapping parcel lines.

Parcel style display order in AutoCAD Civil 3D controls which lot lines are visible where different types overlap.

For more information, see the AutoCAD Civil 3D Help topic *Changing Parcel Display Order*.

Change parcel style display order

- 1 Open *Parcel-3A.dwg*, which is located in the [tutorial drawings folder](#) (page 819).
- 2 In Toolspace, on the Prospector tab, expand the Sites ► Site 1 collection. Right-click the Parcels collection. Click Properties.
In the Parcel Style Display Order area, note that Single-Family parcels have the highest display order, which explains why their magenta lines cover the blue Standard lines.

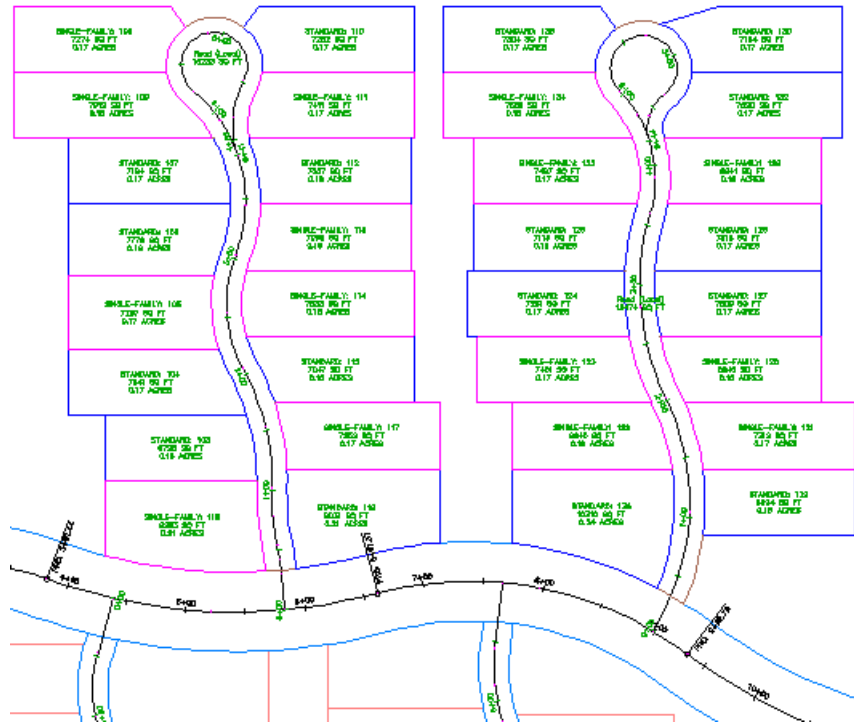

- 3 In the Parcel Style Display Order list, select Standard and click  to move it to the top of the stack.
- 4 Click Apply.
After the model regenerates, notice that the blue Standard lot lines have overwritten the pink ones for Single-Family lots.

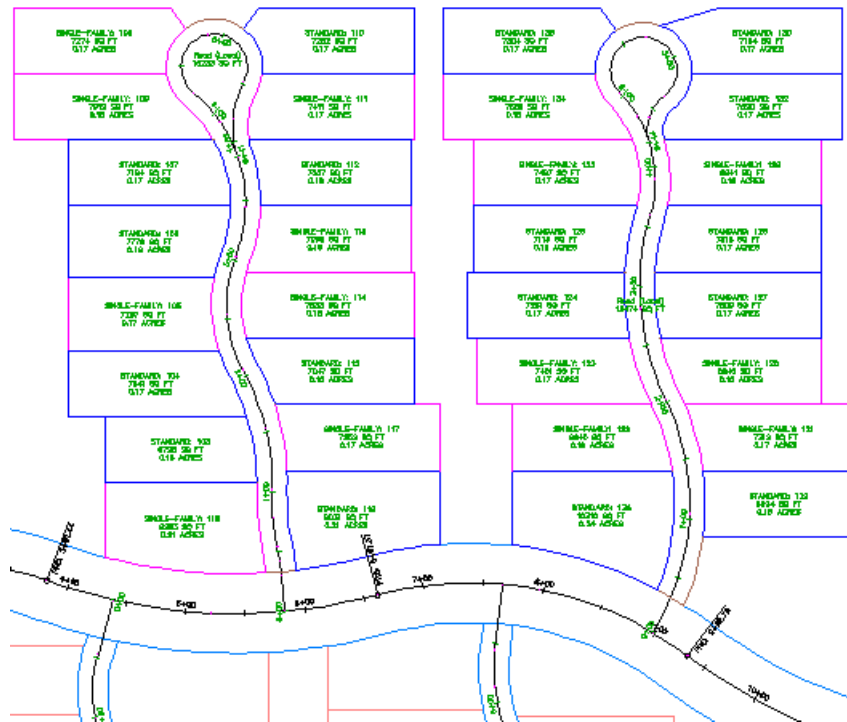

- 5 Repeat steps 3 and 4, but give the Property style the highest display order. This setting displays a light blue line around the extents of the site.

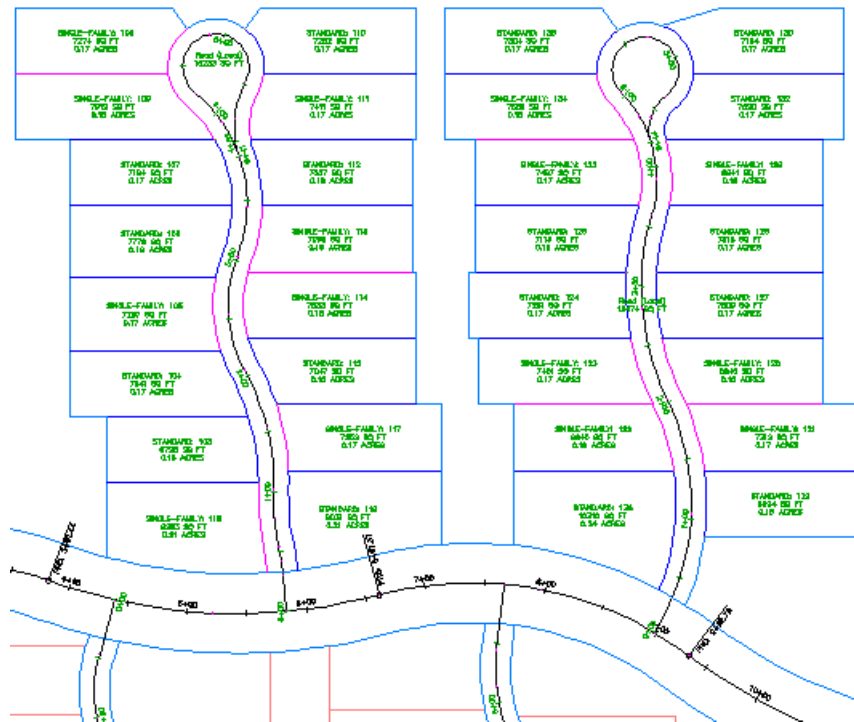

Further exploration: Change the display order again, moving the Road (Local) parcels to the top of the display order, then moving them to a position between Standard and Single-Family. These settings change the display of the curved road edges.

6 Click OK.

To continue this tutorial, go to [Exercise 2: Exporting Parcel Data](#) (page 385).

Exercise 2: Exporting Parcel Data

In this exercise, you will generate a mapcheck report for the parcels in the residential road at the top right of the drawing.

In AutoCAD Civil 3D you can export inverse or mapcheck reports for either a single parcel, a series of parcels, or all parcels in a site.

For more information, see the AutoCAD Civil 3D Help topic *Exporting a Parcel Inverse or Mapcheck Report*.

This exercise continues from [Exercise 1: Changing Parcel Style Display Order](#) (page 382).

To export parcel data

NOTE This exercise uses *Parcel-3A.dwg* with the modifications you made in the previous exercise.

- 1 On the Toolspace Prospector tab, expand Sites ► Site 1 ► Parcels.
- 2 In the list view below the Prospector tree, click the heading of the Number column to sort the parcels by number.
- 3 Select parcel numbers 120 through 136. Parcel number 136, STANDARD: 131, represents the road on which the parcels are located. Ctrl+click parcel number 136 in the list view to deselect it and exclude it from the analysis.
- 4 In the list view, right-click and select Export Analysis.
- 5 In the Export Parcel Analysis dialog box, specify the following parameters:
 - Destination File: Click  and navigate to the [My Civil Tutorial Data folder](#) (page 819). Name the file *ExportAnalysis.txt*.
 - Analysis Type: Mapcheck Analysis
- 6 Click OK.

The *ExportAnalysis.txt* file automatically opens in the text editor associated with AutoCAD Civil 3D and is saved in the location you specified in Step 5.

NOTE If the file does not automatically open, open it from the [My Civil Tutorial Data folder](#) (page 819).

Grading Tutorials

11

These tutorials will get you started with adjusting grading settings, creating gradings, and editing gradings to balance cut and fill volumes.

A grading object in AutoCAD Civil 3D, like an alignment or a surface, has its own properties and behaviors.

NOTE All drawings used in these tutorials are available in the [tutorial drawings folder](#) (page 819). If you want to save your work from these tutorials, save the drawings to the [My Civil Tutorial Data folder](#) (page 819) so that you do not overwrite the original drawings.

For more information, see the AutoCAD Civil 3D Help topic *Understanding Grading Objects*.

Tutorial: Setting up Grading Standards

This tutorial demonstrates how to adjust grading settings, criteria, and styles.

Grading settings are used for managing the work environment and specifying the units for grade and slope values.

There are many common grading situations. For example, you may frequently need to create grading with a slope of 3:1 and a target of a relative elevation. By defining a *grading criteria* with these settings and saving it, you can easily apply these same criteria to other gradings.

Grading styles control the display of each grading component. You can create different styles to use for different types of gradings. For example, you can create styles to display different colors for cut and fill slopes.

For more information, see the AutoCAD Civil 3D Help topics *Using Grading Criteria* and *Using Grading Styles*.

Exercise 1: Reviewing Grading Settings

In this exercise, you will learn how to use grading settings.

For more information, see the AutoCAD Civil 3D Help topic *Changing Grading Settings*.

Review grading settings

- 1 Open *Grading-1.dwg*, which is located in the [tutorial drawings folder](#) (page 819).
- 2 In Toolspace, on the Settings tab, right-click Grading ► Edit Feature Settings.
- 3 In the Edit Feature Settings dialog box, expand the General collection.
- 4 In the Save Command Changes To Settings property, verify that the value is set to Yes.
This setting saves command settings for reuse. For example, if you create a grading and set the grade to 5%, then 5% is the default value the next time you create a grading.
- 5 Expand the collections for Grade, Slope, and Grade/Slope.
Notice the options for unit format and precision. The integer value for precision specifies the number of digits to the right of the decimal place.
- 6 Click OK.

To continue this tutorial, go to [Exercise 2: Creating Grading Criteria](#) (page 388).

Exercise 2: Creating Grading Criteria

In this exercise, you will create a grading criteria set for a ditch grading, then create three criteria in the set.

Each grading criteria provides a standard formula for creating a graded slope. Individual criteria values can be locked so that they cannot be changed for individual gradings.

For more information, see the AutoCAD Civil 3D Help topic *Using Grading Criteria*.



This exercise continues from [Exercise 1: Reviewing Grading Settings](#) (page 388).

Create a criteria set

NOTE This exercise uses *Grading-1.dwg* with the modifications you made in the previous exercise.

- 1 In Toolspace, on the Settings tab, expand the Grading collection.
- 2 Expand the Grading Criteria Sets collection.
The Grading Criteria Sets collection displays the existing grading sets for the drawing. You will create a new grading criteria set then create two new criteria within the new set.
- 3 Right-click Grading Criteria Sets. Click New.
- 4 In the Grading Criteria Set Properties dialog box, enter Ditch Criteria Set in the Name field, and optionally enter a description.
- 5 Click OK.
The new criteria set is displayed in the Grading Criteria Sets collection.

Create a grading criteria

- 1 Right-click Ditch Criteria Set. Click New.
- 2 In the Grading Criteria dialog box, click the Information tab.
- 3 In the Name field, enter Distance @ -6%.
This criteria creates a grade to a distance of 10 feet at -6% grade.
- 4 Click the Criteria tab and specify the following parameters:
 - Target: Distance
 - Distance: 10.000'
 - Projection: Slope
 - Format: Grade
 - Grade: -6.000%
- 5 For the Grade parameter, click  to change it to . When you lock a grade value in a grading criteria, you are not prompted to specify its value each time you use the criteria.
- 6 Click OK.

Create a second grading criteria

- 1 Create a second criteria by repeating the previous procedure. However, use the name Surface @ 4-1 Slope and set the following values for the criteria:

- Target: Surface
- Projection: Cut/Fill Slope
- Search Order: Cut First

Set the following values for both the Cut Slope Projection and Fill Slope Projection property groups:

- Format: Slope
- Slope: 4:1

This criteria creates a grade to an existing surface at a 4-to-1 slope. In the next few steps, you will create another grading criteria by copying an existing one.

- 2 Click OK to close the Grading Criteria dialog box.

Copy a grading criteria

- 1 In the Grading Criteria Sets collection, expand the Basic Set. Right-click the Relative Elevation @ Slope criteria. Click Copy.
- 2 In the Grading Criteria dialog box, change the name to Relative Elevation @ 3-1 Slope. Specify the following parameters:

- Target: Relative Elevation
- Relative Elevation: -3.0'
- Projection: Slope
- Format: Slope
- Slope: 3:1

This criteria creates a grade to a relative elevation of -3 feet at a 3-to-1 slope.

- 3 Click OK to close the Grading Criteria dialog box.
- 4 On the Toolspace Settings tab, click and drag the new criteria (Relative Elevation @ 3-1 Slope) from the Basic Set to the Ditch Criteria Set.

When you create a criteria by copying, the new criteria name must be unique within the drawing, regardless of criteria set.

To continue this tutorial, continue to [Exercise 3: Creating Grading Styles](#) (page 391).

Exercise 3: Creating Grading Styles

In this exercise, you will create a new grading style and slope pattern.

For more information, see the AutoCAD Civil 3D Help topic *Using Grading Style*.

This exercise continues from [Exercise 2: Creating Grading Criteria](#) (page 388).

Create a new grading style

NOTE This exercise uses *Grading-1.dwg* with the modifications you made in the previous exercise.

- 1 In Toolspace, on the Settings tab, right-click the Grading Styles collection. Click New.
- 2 In the Grading Style dialog box, click the Information tab. Enter Ditch into the name field. Optionally, enter a description for the style.
- 3 Click the Display tab and change the color of the Daylight Line to red by clicking its entry in the Color column.
The Select Color dialog box is displayed, where you can select a color. Select red, then click OK.
- 4 Click the Slope Patterns tab.
- 5 Select the Slope Pattern check box. Select the Basic style.
- 6 Click the style drop down list and click Copy Current Selection.
- 7 In the Slope Pattern Style dialog box, on the Information tab, change the name to Ditch Slope.
- 8 On the Layout tab, in the Component field, select Component 2.
The parameter table displays values for Component 2, which is the second slope pattern component from the left side. In this case, it is a long line with a tapered line symbol along the top of the slope.
- 9 In the Slope Line Symbol section, change the Symbol Type to None.

Further exploration: For Component 1, in the Slope Line section, change Percent Of Length to a higher value. You can see the results in the Preview pane.

- 10 Click OK. The new Ditch Slope pattern is selected for the Ditch grading style.
- 11 To view summary information about the style, click the Summary tab.
- 12 Click OK.

In Toolspace, on the Settings tab, the Ditch grading style is added to the Grading Styles collection. The Ditch Slope pattern is added to the General ► Multipurpose Styles ► Slope Pattern Styles collection.

To continue to the next tutorial, go to [Creating Gradings](#) (page 392).

Tutorial: Creating Gradings

This tutorial demonstrates how to create a feature line and how to grade from the feature line.

You can create gradings from parcel lot lines or *feature lines*. A feature line is a linear object that the grading commands can recognize and use as a baseline. When designing a grading, you must often adjust the elevations along a feature line. You create a feature line by converting existing objects, such as lines or polylines.

In the next two exercises, you will perform the following tasks:

- Create three feature lines.
- Assign elevation values along the feature lines using several methods.
- Create a set of gradings from one of the feature lines.

For more information, see the AutoCAD Civil 3D Help topic *Creating Grading*.

Exercise 1: Creating Feature Lines

In this exercise, you will use two different methods to create feature lines.

Feature lines can be either drawn with straight and curved feature line segments, or created from existing alignments or AutoCAD lines, arcs, polylines, or 3D polylines.



A feature line can be used as a grading baseline, but not as a target.

For more information, see the AutoCAD Civil 3D Help topic *Creating Feature Lines*.

This exercise continues from the [Setting Up Grading Standards](#) (page 387) tutorial.

Create feature lines from AutoCAD objects

NOTE This exercise uses *Grading-1.dwg* with the modifications you made in the previous tutorial, or you can open *Grading-2.dwg* from the [tutorial drawings folder](#) (page 819).

- 1 Click Home tab ► Draw panel ►  Line. Draw a line from circle A to B to C.
- 2 Click Home tab ► Create Design panel ► Feature Line drop-down ► Create Feature Lines From Objects .
- 3 Click both lines, then right-click and click Enter to end the selection.
In the Create Feature Lines dialog box, notice that you can assign a name to the feature lines as they are created. Naming significant feature lines can make it easier to assign targets when creating a corridor. For this exercise, you will assign names after the feature lines have been created. Following this workflow enables you to create many feature lines at the same time, but name only the most significant feature lines.
- 4 In the Create Feature Lines dialog box, click OK.
The lines are converted to feature lines and added to Site 1. You will assign elevation values to these feature lines later in this exercise. Next, you will draw a feature line and specify elevations along the line.

Name the feature lines

- 1 In the drawing, select feature lines AB and BC. Right-click. Click Apply Feature Line Names.
- 2 In the Apply Feature Line Names dialog box, click .
- 3 In the Name Template dialog box, for Property Fields, select Next Counter. Click Insert. Click OK.

- 4 In the Apply Feature Line Names dialog box, place the cursor at the beginning of the Name field. Enter ABC.
The Name field should contain ABC <[Next Counter]>.
Click OK.
- 5 In Toolspace, on the Prospector tab, expand Sites ► Site 1. Select the Feature Lines collection.
Notice that the two feature lines and their names are displayed in the Prospector list view.
Next, you will draw a feature line and specify elevations along the line.

Draw a feature line

- 1 Click Home tab ► Create Design panel ► Feature Line drop-down ► Create Feature Line .
- 2 In the Create Feature Lines dialog box, specify the following parameters:
 - Name Check Box: Selected
 - Name: CDEF <[Next Counter]>
 - Style Check Box: Selected
 - Style: Ditch
- 3 In the Create Feature Lines dialog box, click OK.
- 4 In the drawing window, snap to the end of the feature line inside circle C. When prompted, enter 688.00 as the elevation.
You have entered a known value for the starting elevation. In the following steps, you will use the transition command to defer entering elevation values at intermediate points along the feature line.
- 5 Stretch the feature line and click inside circle D. When prompted for an elevation, enter T.
- 6 Stretch the feature line and click inside circle E. When prompted for an elevation, press Enter to accept Transition.
- 7 Stretch the feature line and click inside circle F. When prompted for a transition, enter SU to use the elevation of the surface at that point.
- 8 Note the surface elevation shown at the command line. Press Enter twice to accept the elevation and end the command.

- 9 In Toolspace, on the Prospector tab, expand Sites ► Site 1. Select the Feature Lines collection.
Notice that the three feature lines you created are displayed in the list view. You can use this box to edit the feature lines' name, style, and layer, and view other properties of all the feature lines.

To continue this tutorial, go to [Exercise 2: Assigning Feature Line Elevations](#) (page 395).

Exercise 2: Assigning Feature Line Elevations



In this exercise, you will assign elevations to the feature lines you created from AutoCAD lines in the previous exercise.

For more information, see the AutoCAD Civil 3D Help topic *Editing Feature Lines*.

This exercise continues from [Exercise 1: Creating Feature Lines](#) (page 392).

Edit feature line elevations

NOTE This exercise uses *Grading-2.dwg* with the modifications you made in the previous exercise.

- 1 Click Modify tab ► Edit Elevations panel ► Elevation Editor .
- 2 Click the feature line that stretches from circles C, D, E, to F.
In the Grading Elevation Editor, you see the length of each segment and elevations at each vertex. Notice that as you specified in [Exercise 1: Creating Feature Lines](#) (page 392), the elevation of the first point is 688.000 and the elevation of the last point matches the elevation of the surface. The elevation values of the two intermediate points are automatically interpolated based on the beginning and end-point values. You can use this table to edit the elevation and grade values. Now you will assign elevation values to line AB.
- 3 Click , and then click the feature line between circles A and B. The Grading Elevation Editor now displays the elevations along the feature line between circles A and B.
- 4 Double-click the elevation value for the starting station (0+00.00), and change it to 630.00'. This value puts it a few feet below the surface. Change the elevation of the end point to 690.00'.

In the next few steps, you will insert an elevation point on the feature line.

Insert an elevation point on a feature line

- 1 In the Grading Elevation Editor, click  (Insert Elevation Point).
On feature line AB, you see a small circle and a tooltip that shows the station value and elevation of the point. You can use the cursor to move this point to a new location.
- 2 Move the point to a location near the middle of the feature line, then click.
- 3 In the Insert PVI dialog box, optionally move the elevation point to a specific station. Click OK.
The point is added to the table in the Grading Elevation Editor, where you can edit the station, elevation, grade, and length (distance between points).
- 4 Click feature line AB.
Editing grips are displayed for the endpoints and elevation point. You can click the elevation point and slide it along the feature line. You can also click one of the endpoints and move it to a new location. When you do any grip editing, values in the Grading Elevation Editor update.
- 5 Move the cursor over the surface near the elevation point to see the surface elevation displayed.

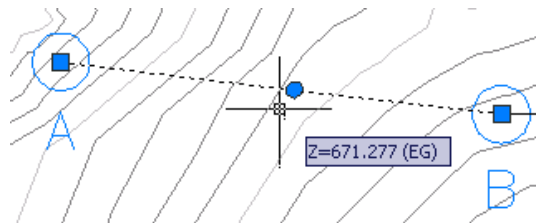

- 6 In the Grading Elevation Editor, set the elevation point to an elevation that is at or below the surrounding surface.
In the next few steps, you will drape feature line BC across the existing ground surface. This command assigns an elevation to each vertex of the feature line.

Drape a feature line on a surface

- 1 If necessary, press Esc once or twice to deselect feature line AB.
- 2 Click Modify tab ► Edit Elevations panel ►  Elevations From Surface.
- 3 In the Set Elevations From Surface dialog box, click OK.
- 4 Click feature line BC, then right-click and click Enter to end the command.
- 5 Click feature line BC again. An elevation point has been added wherever the line crosses the edge of a triangle in the TIN surface.
- 6 Right click and click Elevation Editor.

The Elevation Editor displays data for each elevation point along feature line BC, including its elevation, and the distance and grade to the next point. A feature line on the surface like this can be a useful starting point for a grading. You can use controls along the top of the Grading Elevation Editor to add and delete elevation points, and to adjust their elevations. You can select multiple points within the table for group operations, such as raising or lowering them the same amount, or “flattening” their elevations to the same value.
- 7 Click  to close the Grading Elevation Editor.

To continue this tutorial, go to [Exercise 3: Creating a Grading](#) (page 397).

Exercise 3: Creating a Grading





In this exercise, you will create a set of gradings, called a grading group, that form a runoff on the side of an embankment.

For more information, see the AutoCAD Civil 3D Help topic *Creating Grading from a Footprint*.

This exercise continues from [Exercise 2: Assigning Feature Line Elevations](#) (page 395).

Create a grading group and specify grading creation settings

NOTE This exercise uses *Grading-2.dwg* with the modifications you made in the previous exercise, or you can open *Grading-3.dwg* from the [tutorial drawings folder](#) (page 819).

- 1 Click Home tab ► Create Design panel ► Grading drop-down ► Grading Creation Tools .
- 2 In the Grading Creation Tools toolbar, click  Set The Grading Group.
- 3 In the Create Grading Group dialog box, specify the following parameters:
 - Name: Ditch Drainage
 - Automatic Surface Creation: Selected
 - Volume Base Surface: Selected
- 4 Click OK.
- 5 In the Create Surface dialog box, click OK.
- 6 In the Grading Creation Tools toolbar, click  Select a Criteria Set.
- 7 Select Ditch Criteria Set from the list. Click OK.
- 8 In the Select A Grading Criteria list, ensure that Distance @ -6% is selected.
- 9 Click  to expand the Grading Creation Tools toolbar.
- 10 In the Style list, select Ditch.

Create gradings

- 1 Click  Create Grading. Click feature line AB.
- 2 In response to the command-line prompt, click above the feature line to indicate where to apply the grading.
- 3 Press Enter (Yes) to apply the grading to the entire length of the feature line.
- 4 Press Enter to accept the default distance (10 feet).

The grading is created. Ditch Drainage is added to the grading groups collection in Site 1 on the Toolspace Prospector tab. This grading creates

one side of a ditch, extending down from the baseline at a 6% grade for a distance of 10 feet.

- 5 Press Esc to end the command.

In the next few steps, you will create another grading from the target line of the first grading to the existing surface.

- 6 Set your display so that feature line AB fills most of the drawing window.

- 7 Click the Select a Grading Criteria list and click Surface @ 4-1 Slope.

- 8 Click  Create Grading and click the red target line from the first grading that you created.

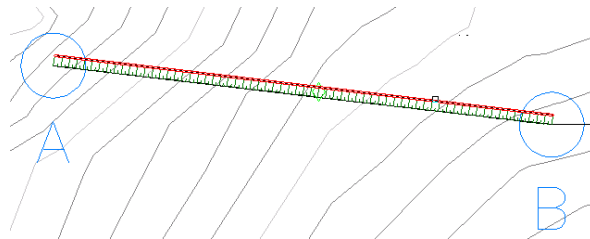

- 9 Enter Yes to apply the grading to the entire length of the line.

- 10 Press Enter to accept the cut slope (4:1).

- 11 Press Enter to accept the fill slope (4:1).

- 12 Press Esc to end the command.

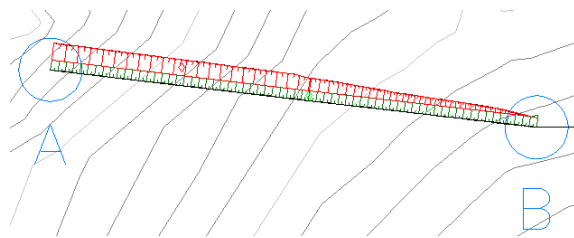

The grading is created. This grading creates a 4:1 slope up from the bottom of the ditch to the surface. Your results may differ from the illustration.

NOTE The Event Viewer might notify you that duplicate points have been ignored. A surface was created from the two gradings, which share a common feature, and therefore share point data. The daylight line of the first grading is the baseline of the second grading. When the surface is created, the data from the points was extracted for each grading. Because the point data is duplicate, the data of one of the two instances of each point is ignored.

To continue to the next tutorial, go to [Editing Gradings](#) (page 400).

Tutorial: Editing Gradings

This tutorial demonstrates common grading editing tasks, including elevation adjustment and grading criteria editing.

You use the Grading Elevation Editor to edit elevations along a baseline. A baseline is a feature line or lot line that has had a grading applied to it. You can modify the elevations of a lot line unless it is being used as a target for a grading.

You can also insert a PVI (Point of Vertical Intersection) between the start and end stations of the baseline, creating an intermediate elevation point.

For more information, see the AutoCAD Civil 3D Help topic *Editing Grading*.

Exercise 1: Editing the Grading Elevation

In this exercise, you will edit the elevation of a grading baseline. The grading adjusts to reflect the elevation change.

For more information, see the AutoCAD Civil 3D Help topic *Editing Grading Criteria*.

Edit feature line elevations

- 1 Open *Grading-4.dwg*, which is located in the [tutorial drawings folder](#) (page 819).

This drawing contains a rectangular building pad graded to the surrounding surface at a 3:1 slope. Where the slope pattern is green, it is a fill slope in which the grading slopes down from the pad to the surface. Where the slope pattern is red, it is a cut slope in which the grading slopes up from the pad.

- 2 Click **Modify** tab ► **Edit Elevations** panel ► **Elevation Editor**  .

- 3 In the drawing, select the baseline for the grading (rectangular line).

NOTE The surface style for the building pad grading has borders turned off, making it easier to select the baseline. Otherwise, the surface border would be on top of the baseline.

The Elevation Editor shows the following grading settings for each corner of the feature line in a clockwise direction. The starting point is the upper left corner.

- Station — Distance from the start of the feature line.
- Elevation — Elevation of the current point.
- Length — Distance to the next point.
- Grade Ahead — Grade toward the next point. Adjusting this setting holds the elevation of the current point and adjust the elevation of the next point for the new grade.
- Grade Back — Grade from the previous point. Adjusting this setting affects the elevation of the current point, holding the elevation of the next point for the new grade.

Further exploration: Another way to review and edit the elevations of a feature line is to click Modify tab ► Edit Elevations panel ► Elevation Editor . A triangular marker is displayed at the starting point of the feature line. Press Enter to move to the next point. You can edit data on the command line.



- 4 In the Grading Elevation Editor, Shift+click the third and fourth rows to select them.
- 5 Double-click the elevation value in one of the rows and change it to 730 feet.

Both of the selected rows' elevation values change to 730 feet. Notice that the shape of the grading and the Grade Ahead and Grade Back values have changed to reflect the elevation change.

Edit feature line grades

- 1 Select the first three rows in the table. Click  Flatten Grade or Elevations.
- 2 In the Flatten dialog box, select Constant Grade. Click OK.

The first two points are set to the same grade, and the shape of the grading changes in response to the elevation change. Flattening the grade holds the elevation values of the first and last selected points and modifies elevations of the points in between.

- 3 Click  Show Grade Breaks Only.
The second station's row is hidden, because there was no difference in grade between it and the previous station.
- 4 In the first row, change the Grade Ahead value to -3.000%.
- 5 Click  Show Grade Breaks Only.
Notice that the second station's grade has changed to reflect the change you made in step 4.
- 6 Click  to close the Grading Elevation Editor.

To continue this tutorial, go to [Exercise 2: Balancing Cut and Fill Volumes](#) (page 402).

Exercise 2: Balancing Cut and Fill Volumes

In this exercise, you will adjust the elevation of a building pad to balance the cut and fill volumes.

For more information, see the AutoCAD Civil 3D Help topic *Displaying and Adjusting Surface Volumes*.

This exercise continues from [Exercise 1: Editing the Grading Elevation](#) (page 400).

Balance cut and fill volumes



NOTE This exercise uses *Grading-4.dwg* with the modifications you made in the previous exercise, or you can open *Grading-5.dwg* from the [tutorial drawings folder](#) (page 819).

- 1 Click Analyze tab ► Volumes And Materials panel ► Grading Volume Tools .
On the Grading Volume Tools toolbar, notice that the Group is set to Building Pad, which is the only grading group in the drawing. The fields

for Cut, Fill, and Net show that the grading as designed requires the net cutting and removal of a large volume of surface material.

- 2 Click  Raise the Grading Group to raise the building pad elevation by one foot. Note the changes to cut and fill requirements.

Further exploration: You can also click  Lower the Grading Group and you can change the elevation increment to a value other than 1.0.

- 3 Click  Automatically Raise/Lower to Balance the Volumes.
- 4 In the Auto-Balance Volumes dialog box, leave the Required Volume set to 0, or change the value if you wish. Click OK.
The elevation of the building pad is adjusted to bring the Net amount as close as possible to the set value.
- 5 Click  (Expand the Grading Volume Tools). The history of your elevation changes and their effects is displayed.

To continue this tutorial, go to [Exercise 3: Editing the Grading Criteria](#) (page 403).

Exercise 3: Editing the Grading Criteria

In this exercise, you will edit a grading criteria and an associated grading adjusts to reflect the criteria change.

You will edit grading criteria attribute values in two ways:



- In the Elevation Editor dialog box. Using this method updates the grading criteria for only the currently selected grading object.
- Directly in the Grading Criteria settings. Using this method will apply the attribute changes to future grading objects created with the criteria. If the attribute value is locked, attribute changes will also be applied to grading objects that currently use the criteria.

For more information, see the AutoCAD Civil 3D Help topic *Editing Grading Criteria*.

This exercise continues from [Exercise 2: Balancing Cut and Fill Volumes](#) (page 402).

This exercise uses the drawing *Grading-3A.dwg*, which contains two grading groups that use the same grading criteria.

Edit the grading criteria

- 1 Open *Grading-3A.dwg*, which is located in the [tutorial drawings folder](#) (page 819).
- 2 Click Modify tab ► Design panel ► Grading.
- 3 Click Grading tab ► Modify panel ► Grading Editor .
- 4 Click inside the grading that projects from feature line AB.
- 5 In the Grading Editor Panorama, change the distance value to 5.0000.
Notice that grading AB updates to reflect the change. Now, you will make a similar change that will affect all grading groups using the Distance @ -6% grading criteria.
- 6 In Toolspace, on the Settings tab, expand Grading ► Grading Criteria Sets ► Ditch Criteria Set.
- 7 Right-click Distance @ -6%. Click Edit.
- 8 In the Grading Criteria dialog box, click the Criteria tab. Change the Distance parameter to 20 and click . This locks the attribute value, which will apply it to all grading objects that currently use the Distance @ -6% grading criteria. Leaving the value unlocked applies the value to only grading objects that are created in the future.
- 9 Click OK.
The AB and BC grading objects are both updated in the drawing to account for the new criteria value.

To continue to the next tutorial, go to [Grading from a Complex Building Footprint](#) (page 404).

Tutorial: Grading from a Complex Building Footprint

This tutorial demonstrates how to grade around a building footprint that has relatively complicated geometry and variations in elevation.

The drawing used in this tutorial contains a surface and a building pad that consists of two tiers connected by a small ramp. The elevation of the top portion of the building pad is 402 feet, and the bottom portion is 400 feet.

Projection grading, also known as *slope* grading, involves projecting a slope from a feature line to a specified target. Projection grading targets include an intersection with a surface, or a specified distance, elevation, or elevation difference. The ramp that connects the two tiers consists of arcs and inside corners, both of which complicate a grading plan. Simply applying projection grading, which was demonstrated in the [Creating a Grading exercise](#) (page 397), would result in a grading that overlaps itself.

In this tutorial, you will learn how to create a successful grading solution for similarly complicated scenarios. After you have completed this tutorial, proceed to the [Using Feature Lines to Modify a Grading tutorial](#) (page 412) to learn how to modify the grading solution, using the AutoCAD Civil 3D feature line editing tools.

For more information, see the AutoCAD Civil 3D Help topic *Creating Grading*.

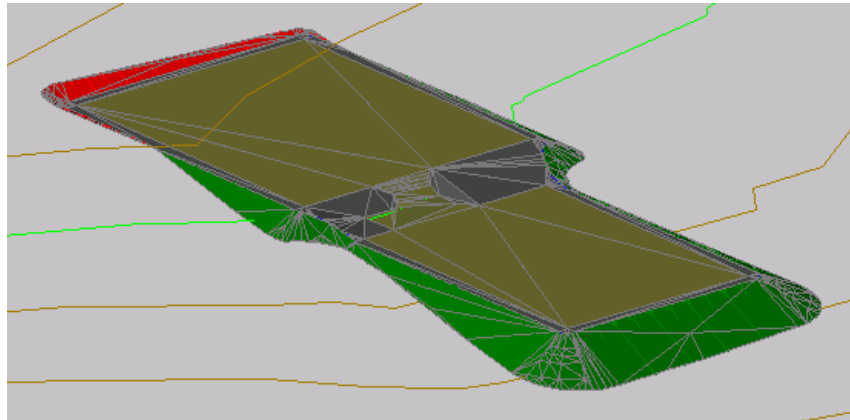

Exercise 1: Simplifying a Building Footprint

In this exercise, you will use the feature line stepped offset command to generate a simplified footprint from which to grade.

The drawing you will use in this tutorial displays a building pad in two vertically arranged viewports. In the right viewport, the building pad is shown in plan view. You will design the building pad in the right viewport. In the left viewport, the building pad is displayed in model view. You will use this viewport to see the status of the design as you work.

For more information, see the AutoCAD Civil 3D Help topic *Editing Feature Lines*.

Create a stepped offset feature line

- 1 Open *Grading-6.dwg*, which is located in the [tutorial drawings folder](#) (page 819).
- 2 On the command line, enter `OffsetGapType`. Enter 1 as the value.
The `OffsetGapType` variable controls how potential gaps between segments are treated when closed polylines, such as the building pad feature line, are offset. Setting this variable to 1 fills the gaps with filleted arc segments; the radius of each arc segment is equal to the offset distance.
- 3 Click **Home** tab ► **Create Design** panel ► **Feature Line** drop-down ► **Create Feature Line From Stepped Offset** .
- 4 On the command line, enter 1.5 as the offset distance.
- 5 In the right viewport, click the blue feature line representing the building pad when prompted to select a feature line.
- 6 Click outside the building pad when prompted to specify the side to offset.
- 7 At the command line, enter `G` to specify a grade value. Enter -1 as the grade.
- 8 Press Enter to end the command.

The stepped offset feature line is displayed. Notice that in the left viewport, on the left side of the ramp, the curve of the stepped offset feature line is not well formed. Because it is an independent feature line, you can use the feature line editing tools to refine the solution.

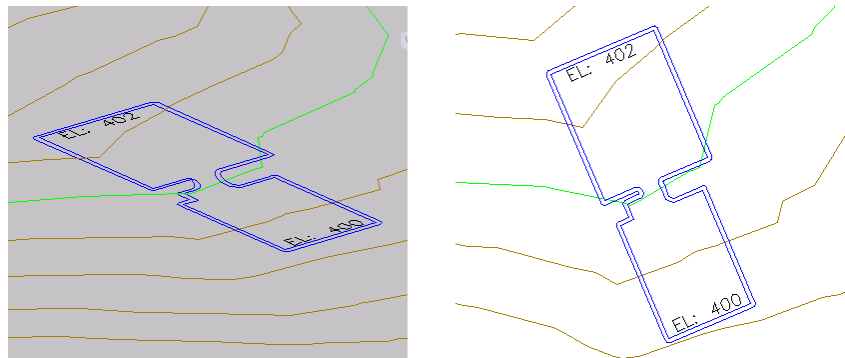

Add fillets to the feature line

- 1 Click Modify tab ► Edit Geometry panel ► Fillet .
- 2 Click the offset feature line when prompted to select an object.
- 3 On the command line, enter R to specify a radius for the fillet. Enter 15.000 as the radius value.
- 4 On each side of the ramp, click a sharp inside corner of the offset feature line.

When you move the cursor over the feature line, a green triangle highlights the corners that can be filleted and a preview fillet is displayed. See the following image for an example of a corner to click.

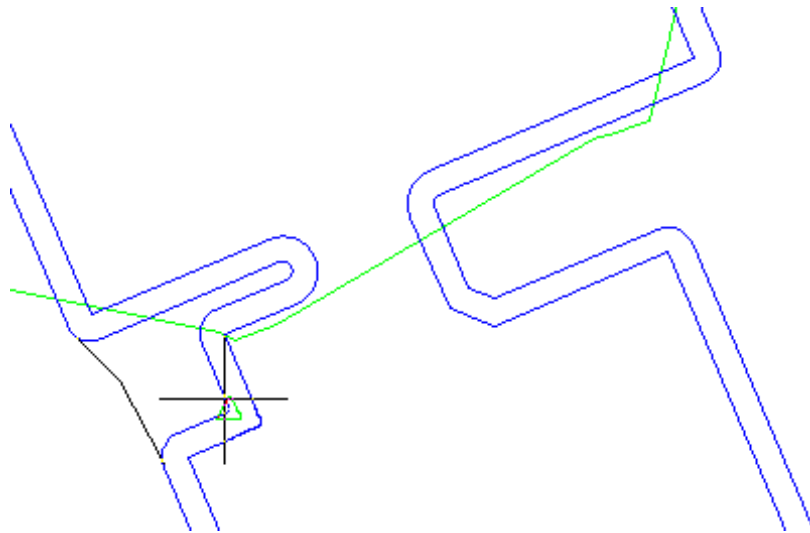

The fillet is applied to the feature line. In the left viewport, notice that the fillet uses the elevations from the existing feature line and smoothly interpolates the elevations along the length of the fillet.



5 Press Enter twice to end the command.

To continue this tutorial, go to [Exercise 2: Grading from a Building Footprint to a Surface](#) (page 408).

Exercise 2: Grading from a Building Footprint to a Surface

In this exercise, you will grade from the simplified, offset footprint to the existing ground surface.





The stepped offset feature line has much simpler geometry than the original footprint. The simpler feature line geometry will result in a much simpler grading than one created directly from the original footprint.

For more information, see the AutoCAD Civil 3D Help topic *Creating Grading*.

This exercise continues from [Exercise 1: Simplifying a Building Footprint](#) (page 405).

Create a grading group and specify grading creation settings

NOTE This exercise uses *Grading-6.dwg* with the modifications you made in the previous exercise.

- 1 Click Home tab ► Create Design panel ► Grading drop-down ► Grading Creation Tools  .
- 2 On the Grading Creation Tools toolbar, click  Set The Grading Group.
- 3 In the Select Grading Group dialog box, under Site Name, ensure that Grading - Building Pad site is selected.
- 4 Under Group Name, click  Create A Grading Group.
- 5 In the Create Grading Group dialog box, for Name, enter Slope Grading With Feature Lines.
- 6 Click OK twice.
- 7 On the Grading Creation Tools toolbar, click  Set The Target Surface.
- 8 In the Select Surface dialog box, ensure that EG surface is selected. Click OK.
- 9 On the Grading Creation Tools toolbar, click  Select a Criteria Set.
- 10 In the Select A Criteria Set dialog box, ensure that Basic Set is selected. Click OK.
- 11 From the Select a Grading Criteria list, select Grade To Surface.

Create a grading

- 1 Click  Create Grading.
- 2 When prompted to select a feature, click the blue feature line that is offset from the building pad.
- 3 When prompted to select the grading side, click outside the offset feature line.
- 4 Press Enter to apply the grading to the entire length of the feature line.
- 5 Press Enter to accept the default Slope Cut Format.

- 6 Press Enter to accept the default 2.00:1 Cut Slope.
- 7 Press Enter to accept the default Slope Fill Format.
- 8 Press Enter to accept the default 2.00:1 Fill Slope.
- 9 Press Esc to end the command.

The stepped offset feature line is graded to the EG surface. Notice that while the cut and fill slopes are shown in red and green, there are still open areas inside the grading group. In the next exercise, you will fill these areas and apply appropriate grading styles.

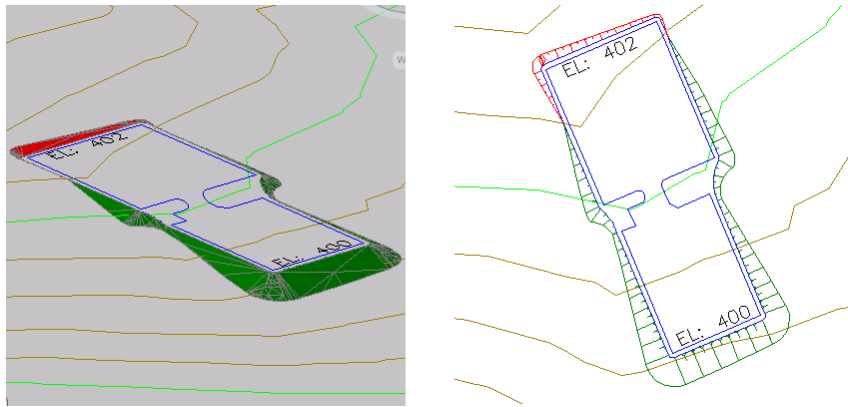

To continue this tutorial, go to [Exercise 3: Filling Holes in a Grading](#) (page 410).

Exercise 3: Filling Holes in a Grading

In this exercise, you will create infill gradings to fill in the open areas inside the grading group.

An *infill grading* has no criteria applied to it. Any area bounded by feature lines or lot lines that is not already a grading can be converted to an infill grading. Using infill gradings to fill in holes in a grading group ensures correct contour display and volume calculations.

For more information, see the AutoCAD Civil 3D Help topic *Filling a Void Area*.

This exercise continues from [Exercise 2: Grading from a Building Footprint to a Surface](#) (page 408).

Create infill gradings

NOTE This exercise uses *Grading-6.dwg* with the modifications you made in the previous exercise.

- 1 On the Grading Creation Tools toolbar, from the Select A Grading Criteria list, select Grade To Distance.

NOTE Although an infill has no criteria, you select its grading style from an existing criteria.

- 2 Click  Expand The Toolbar.

- 3 From the Style list, select Shoulder.

This setting specifies the grading style to apply to the infill.

- 4 Click  Create Infill.

- 5 Click in the area between the building footprint and the offset feature line (near the right side of the ramp).

A diamond is displayed in that area, indicating that an infill has been created. In the left viewport, notice that the infill grading fills the entire area between the two blue feature lines.

- 6 On the Grading Creation Tools toolbar, from the Style list, select Pad.

- 7 Click inside the building footprint to create an infill using the Pad grading style.

- 8 Press Enter to end the command.

In the left viewport, the gray area is the infill grading that represents the shoulder. The gold area is the building pad infill grading. The green and red areas are the grade-to-surface slope grading.



To continue to the next tutorial, go to [Using Feature Lines to Modify a Grading](#) (page 412).

Tutorial: Using Feature Lines to Modify a Grading

This tutorial demonstrates how to use feature lines to control grading around inside corners.

Feature line grading involves creating a set of feature lines to define the graded region as surface breaklines, and then adjusting the elevation of key points to control the shape of the surface. This technique is ideal for wide, fairly flat areas, such as parking lots or building pads. It is also well suited to areas with rapidly changing elevations or slopes where walls would normally be required to grade successfully. You can manually add or remove feature lines and adjust their location in three dimensions to achieve precise slope design. Using this process, you can control water drainage or clean up difficult geometry in areas, such as the intersection of two or more slopes.

For more information, see the AutoCAD Civil 3D Help topic *Editing Feature Lines*.



Exercise 1: Smoothing Feature Line Arcs

In this exercise, you will adjust the tessellation of the arcs around the ramp, which will result in a more accurate representation of the ramp.

For more information, see the AutoCAD Civil 3D Help topic *Editing Feature Lines*.

Modify feature line arc tessellation

NOTE This exercise uses *Grading-6.dwg* with the modifications you made in the previous exercise, or you can open *Grading-7.dwg* from the [tutorial drawings folder](#) (page 819).

- 1 Click the right viewport to make it active.
- 2 Click View tab ► Views panel  Visual Styles drop-down ► 3D Wireframe.
The grading triangulation is displayed in the 3D Wireframe visual style. It is helpful to observe the triangles as you use the feature line to break the surface.
- 3 Click Home tab ► Create Design panel ► Grading drop-down ► Grading Creation Tools  .
- 4 On the Grading Creation Tools toolbar, click  Grading Group Properties.
- 5 In the Grading Group Properties dialog box, on the Information tab, select the Automatic Surface Creation check box.
- 6 In the Create Surface dialog box, click OK.
To adjust the arc tessellation, a surface must be created from the grading group. This surface is temporary. You will delete it after you have adjusted the arc tessellation.
- 7 In the Grading Group Properties dialog box, on the Information tab, change the Tessellation Spacing setting to 1.000'. Click Apply.
- 8 Clear the Automatic Surface Creation check box. When asked if you want to delete the Slope - Projection Grading surface, click Yes. Click OK.
Now that you have updated the arc tessellation, you must update the grading infill areas to apply the new setting. The easiest way to update the infill areas is by using the AutoCAD Move command.
- 9 On the command line, enter MOVE.
- 10 Click the original, interior feature line (the blue building pad). Press Enter.
- 11 Press Enter again to select the default Displacement selection.
- 12 Press Enter again to accept the default displacement of <0.0000, 0.0000, 0.0000>.

In the left viewport, notice that the triangulation of the arcs along the ramp has improved.

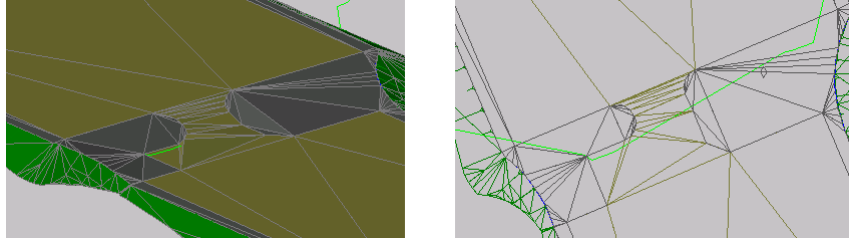

To continue this tutorial, go to [Exercise 2: Adjusting Grading Triangulation with a Feature Line](#) (page 414).

Exercise 2: Adjusting Grading Triangulation with a Feature Line

In this exercise, you will use a feature line to break a poorly triangulated grading surface.

The triangles in the area on the right side of the ramp are steeper than desired. These triangles can be corrected by creating a feature line to break the surface in this area.

For more information, see the AutoCAD Civil 3D Help topic *Editing Feature Lines*.

This exercise continues from [Exercise 1: Smoothing Feature Line Arcs](#) (page 412).

Use a feature line to adjust surface triangulation

NOTE This exercise uses *Grading-7.dwg* with the modifications you made in the previous exercise.

- 1 Click Home tab ► Layers panel ► Layer drop-down. Next to the C-TOPO-FEAT-CROSS layer, click  .
- 2 Zoom in to the area to the right of the ramp.
Notice the polyline between the three circles labeled A, B, and C. You can use the following steps on any polyline. However, this polyline is in a specific location so that you will get the results described in this tutorial.

- 3 Click Home tab ► Create Design panel ► Feature Line drop-down ► Create Feature Lines From Objects .
- 4 Click the polyline between Circles A, B, and C. Press Enter.
- 5 In the Create Feature Lines dialog box, under Site Name, make sure that Grading - Building Pad is selected.
- 6 Under Conversion Options, make sure that the Erase Existing Entities and Assign Elevations check boxes are selected. Click OK.
- 7 In the Assign Elevations dialog box, select From Surface. Make sure that the Insert Intermediate Grade Break Points check box is selected. Click OK.

TIP To reduce processing time when working with larger grading groups, clear the Insert Intermediate Grade Break Points check box. This option adds an elevation point at each point at which the feature line crosses a triangle.

The polyline is converted to a feature line and breaks the triangulation along the right side of the ramp. The new triangulation creates a more gradual slope in the infill area.

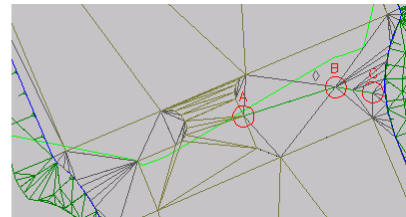
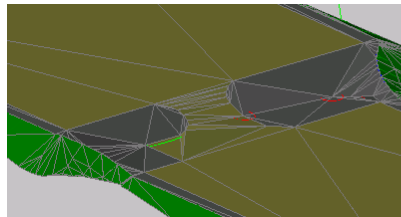

To continue this tutorial, go to [Exercise 3: Working with Crossing Feature Lines](#) (page 415).

Exercise 3: Working with Crossing Feature Lines

In this exercise, you will learn how feature lines interact when they cross each other at and between vertices.



For more information, see the AutoCAD Civil 3D Help topic *Editing Feature Lines*.

This exercise continues from [Exercise 2: Adjusting Grading Triangulation with a Feature Line](#) (page 414).

To work with crossing feature lines



NOTE This exercise uses *Grading-7.dwg* with the modifications you made in the previous exercise, or you can open *Grading-8.dwg* from the [tutorial drawings folder](#) (page 819).

- 1 In the right viewport, select feature line ABC. Right-click. Click Elevation Editor.

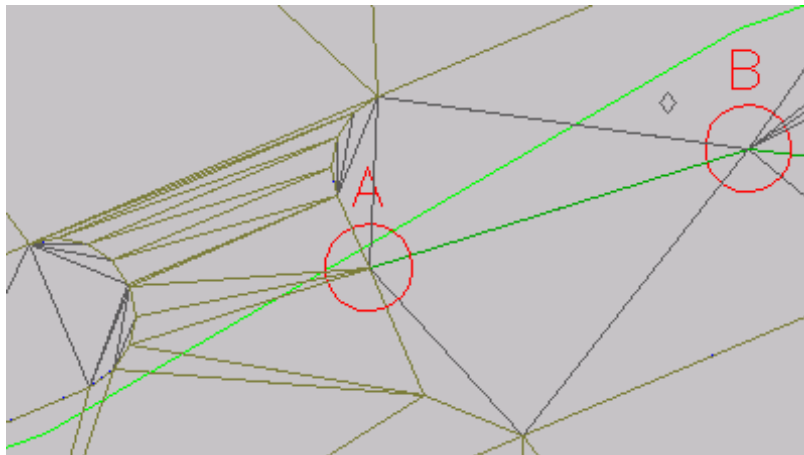

The Grading Elevation Editor displays a list of the points of intersection ( PIs, or horizontal geometry points) and elevation change points ( vertical geometry points) along the feature line.

Notice that the  icon is displayed in the first row. This icon indicates that the building pad feature line also has a PI at this point. When two feature lines cross at a common vertex, both vertices must share the same elevation value. The elevation for both feature lines at this point is determined by whichever feature line was most recently edited. In the following illustration, the common vertex is in Circle A.





- 2 In the Grading Elevation Editor click  Unselect All Rows. Click  Flatten Grade Or Elevations.
- 3 In the Flatten dialog box, select Constant Grade. Click OK.
Notice that in the Grading Elevation Editor, the Grade Ahead and Grade Back values are updated to a consistent value. When you flatten a feature line, the points between the start elevation and the end elevation are set

to the same grade, effectively eliminating the grade breaks. You may flatten either the entire feature line, or a selection of points.

- 4 In the  row, in the Elevation column, change the elevation value to 402.00'.
- 5 In the Grading Elevation Editor, click  Select A Feature Line, Parcel Line, Or Survey Figure.
- 6 In the drawing window, click the building pad feature line.
The elevation points of the building pad are now displayed in the Grading Elevation Editor.
- 7 Locate the row containing the  icon.
Notice that the value in the Elevation column is 402.000', which is the same value you entered for the other feature line in step 4. Change the Elevation value to 405.000'.

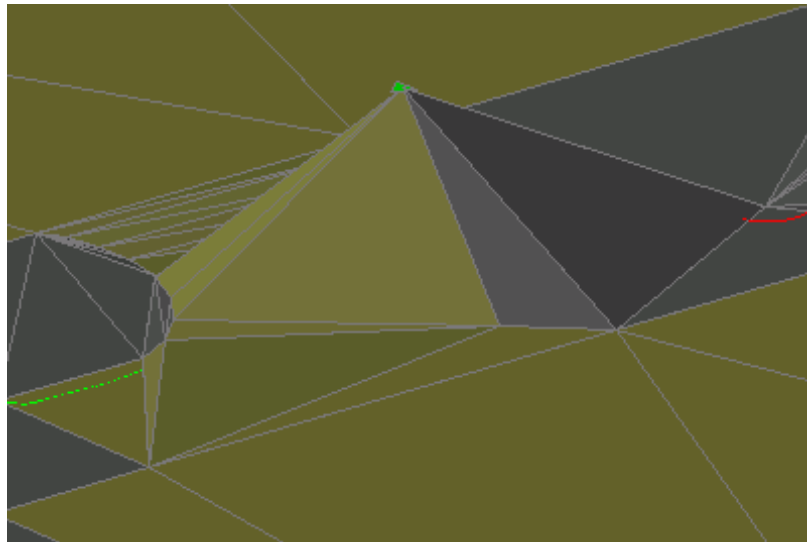

In the left viewport, notice that the value you entered for the shared vertex updated the elevation of both feature lines. As you see in the following image, the new common feature line elevation affected the infill gradings of both the ramp and gray infill area. When two feature lines share a vertex, the elevation of both feature lines at that vertex is determined by whichever of the feature lines was most recently edited.



- 8 In the Grading Elevation Editor, in the  row, change the Elevation value to 400.00'.
- 9 In the right viewport, select feature line ABC. Using the grip inside Circle A, move the beginning point of the feature line toward the lower left of Circle A.



NOTE You may need to hover over the feature line, and then use Shift+spacebar to select the feature line.



- 10 Right-click the feature line. Select Elevation Editor.

In the Grading Elevation Editor, the  icon indicates the point at which the feature line crosses the building pad. The white triangle indicates a *split point*, which is created when two feature lines cross at a location where neither one has a PI. Much like a  shared vertex point, a split point acquires the elevation of the feature line that was most recently edited. If the other feature line has a different elevation, it gets a grade break at the crossing point.

Unlike a shared vertex, there is not an actual point at a split point, so you cannot directly edit the elevation. When you edit one of the feature lines, its grade runs straight through the intersection, forcing the other feature line to break at the split point. You can use the Insert PI command to create a permanent point at that location on one of the feature lines. After you convert a split point to a permanent point, you can edit the elevation of a split point directly, and have better control over that point.

- 11 Select the grip at the beginning point of the feature line. On the command line, enter END to apply an endpoint OSNAP. Snap the feature line to the building pad feature line.

Notice that an  elevation change point with an elevation of 402.000' was added in the second row. The change point was added because you changed the elevation of the endpoint (the  shared vertex) of this feature line to 402.000' in step 4. When you changed the elevation of the shared vertex on the building pad feature line to 400.000' in step 8, the grade break point was created. The grade break point ensures that the elevation of this feature line would match the elevation of the building pad.

- 12 In the Grading Elevation Editor, click . Click  Flatten Grade Or Elevations.

- 13** In the Flatten dialog box, select Constant Grade. Click OK.
The grade flattens, and the elevations updates to accommodate the new grade.

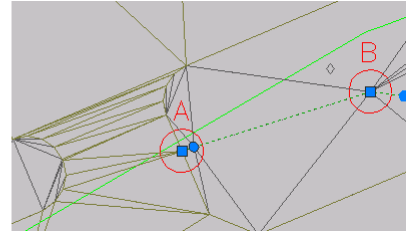
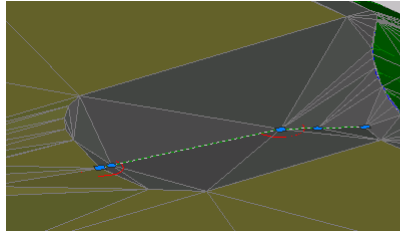

Corridor Assembly Tutorials

12

These tutorials will get you started working with the corridor assemblies, which create the primary structure of AutoCAD Civil 3D corridor models.

The tutorials in this section demonstrate common tasks for working with corridor assemblies for any application. You will learn how to build assemblies for specific types of corridors, including divided highways and corridors with transition lanes, in the [Corridors Tutorials](#) (page 459).

If you have not installed AutoCAD Civil 3D to the default location, you may receive messages in the Event Viewer indicating that subassembly macro paths are not found. To avoid these messages, it is recommended that you follow the exercises in the order presented.

NOTE All drawings used in these tutorials are available in the [tutorial drawings folder](#) (page 819). If you want to save your work from these tutorials, save the drawings to the [My Civil Tutorial Data folder](#) (page 819) so that you do not overwrite the original drawings.

For more information, see the AutoCAD Civil 3D Help topics *Understanding Assemblies* and *Understanding Subassemblies*.

Tutorial: Working with Assemblies

This tutorial demonstrates the basic tasks you will use to use AutoCAD Civil 3D subassemblies to build corridor assemblies.

This tutorial demonstrates common tasks that you can apply when working with corridor assemblies for any application. In the [Corridors Tutorials](#) (page 459), you will learn how to build assemblies for specific types of corridors, including:

- [Assembly with a transition lane](#) (page 464)

- [Divided highway assembly](#) (page 472)

For more information, see the AutoCAD Civil 3D Help topic *Creating Assemblies*.

Exercise 1: Creating an Assembly

In this exercise, you will use some of the subassemblies that are shipped with AutoCAD Civil 3D to create an assembly for a basic crowned roadway with travel lanes, curbs, gutters, sidewalks, and slopes to an existing surface.

NOTE The corridor assembly you build will be used to create a corridor model in the [Creating a Basic Corridor](#) (page 459) tutorial.

For more information, see the AutoCAD Civil 3D Help topic *Creating Assemblies*.

Create an assembly baseline

- 1 Open *Assembly-1a.dwg*, which is located in the [tutorial drawings folder](#) (page 819).
- 2 Click Home tab ► Create Design panel ► Assembly drop-down ► Create Assembly .
- 3 In the Create Assembly dialog box, for name, enter Primary Road Full Section. Click OK.
- 4 When the 'Specify assembly baseline location' prompt is displayed on the command line, click in the rectangle under the profile views.
The viewport zooms to the assembly baseline, which looks like this:



Add a lane subassembly

- 1 If the Tool Palette containing the subassemblies is not visible, click Home tab ► Palettes panel ► Tool Palettes  .
- 2 In the tool palette, right-click the Tool Palettes control bar. Click Civil Metric Subassemblies.
- 3 Click the Lanes tab.



- 4 Click  LaneOutsideSuper.
- 5 In the Properties palette, under ADVANCED, specify the following parameters:
 - Side: Right
 - Width: 3.5
- 6 In the drawing, click the marker point on the assembly baseline.
The right lane subassembly is now attached to the assembly baseline.

Add a curb subassembly



- 1 In the Tool Palettes window, on the Curbs tab, click UrbanCurbGutterGeneral.
- 2 In the drawing, click the marker point at the top-right edge of the travel lane.

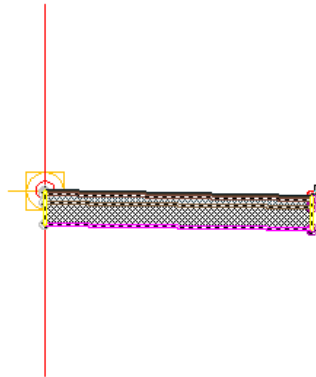

NOTE If you attach the subassembly to the wrong marker, you can move it to the correct location. Press Esc to exit subassembly placement mode. Select the subassembly you wish to move. A blue grip is displayed when the subassembly is selected. Select the grip, and then click the correct marker point.

Add a sidewalk subassembly

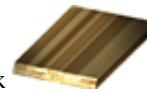

- 1 In the Tool Palettes window, on the Basic tab, click Sidewalk. Basic
- 2 In the Properties palette, under ADVANCED, specify the following parameters:
 - Side: Right
 - Width: 1.5

- Buffer Width 1: 0.5
 - Buffer Width 2: 0.5
- 3 In the drawing, click the marker point at the top, back of the curb.

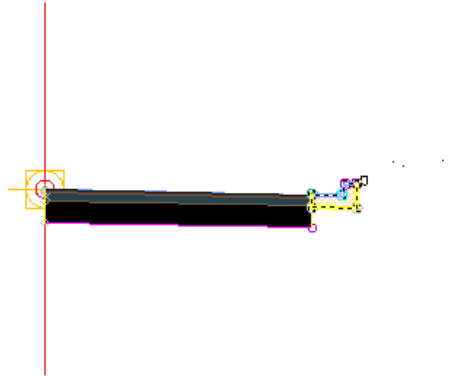

Add a daylight subassembly

- 1 In the Tool Palettes window, on the Basic tab, click  BasicSideSlopeCutDitch.
- 2 In the Properties palette, under ADVANCED, specify the following parameters:
 - Side: Right
 - Cut Slope: 2.000:1
 - Fill Slope: 4.000:1
- 3 In the drawing, click the marker point at the outside edge of the sidewalk subassembly.

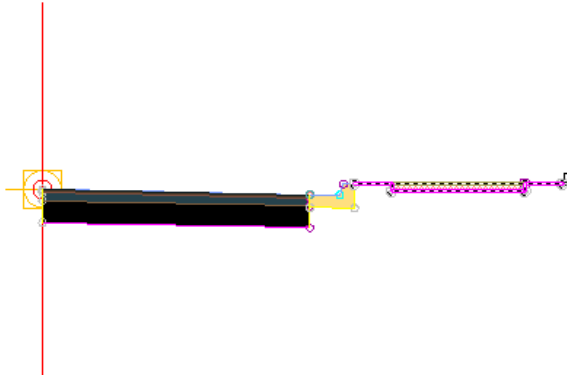

- 4 Press Esc.
This action ends the subassembly placement command.

Mirror the subassemblies to the left of the baseline

- 1 In the drawing, select the four subassemblies you added.

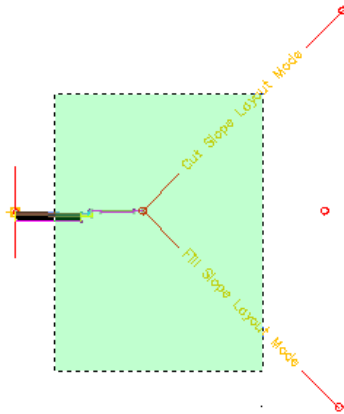

- 2 Right click. Click Mirror.
- 3 Click the marker point on the assembly baseline.
The subassemblies are displayed on the left side of the assembly marker.
The Mirror command creates a mirror image of the selected subassemblies.

All the subassembly parameters, except for the Side parameter, are retained.

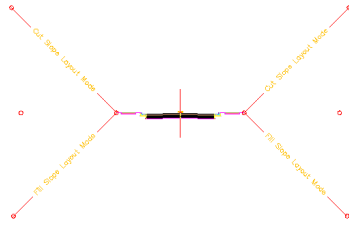

NOTE The parameters of the mirrored subassemblies are not dynamically linked. If you change a parameter value for a subassembly on one side of the assembly baseline, the change will not be applied to the opposite side.

To continue this tutorial, go to [Exercise 2: Modifying the Subassembly Name Template](#) (page 427).

Exercise 2: Modifying the Subassembly Name Template

In this exercise, you will specify a meaningful naming convention to apply to subassemblies as they are created.

This default subassembly naming template specifies that subassemblies use the subassembly name on the tool palette followed by a sequential number. For example, if BasicLane subassemblies are placed on either side of the assembly, they are named BasicLane- (1) and BasicLane - (2).

In this exercise, you will change the naming template so that assemblies will include the side on which the subassembly is placed. For example, if BasicLane subassemblies are placed on either side of the assembly, they are named BasicLane- (Left) and BasicLane - (Right).



Performing this task makes it easy to manage assemblies and subassemblies in complex drawings.

For more information, see the AutoCAD Civil 3D Help topic *Understanding Subassemblies*.

Examine the default subassembly naming convention

- 1 Open *Assembly-1b.dwg*, which is available in the [tutorial drawings folder](#) (page 819).

This drawing contains an assembly baseline that does not have any subassemblies attached to it.

- 2 If the Tool Palette containing the subassemblies is not visible, click Home tab ► Palettes panel ► Tool Palettes  .
- 3 In the tool palette, right-click the Tool Palettes control bar. Click Civil Imperial Subassemblies
- 4 Click the Basic tab.
- 5 Click  BasicLane.
- 6 In the Properties palette, under ADVANCED, set the Side to Right.
- 7 In the drawing, click the marker point on the assembly baseline. The right lane subassembly is now attached to the assembly baseline.
- 8 In the Properties palette, under ADVANCED, set the Side to Left.
- 9 In the drawing, click the marker point on the assembly baseline. The left lane subassembly is now attached to the assembly baseline.
- 10 Press Esc.
- 11 In Toolspace, on the Prospector tab, select the Subassemblies collection. In the Toolspace list view, notice that there are two BasicLane subassemblies. Because this assembly has more than one of the same subassembly, the sequential naming convention makes it difficult to distinguish between them. You will correct this in the following steps.

Modify the subassembly name template

- 1 In Toolspace, on the Settings tab, right-click the Subassembly collection. Click Edit Feature Settings.
- 2 In the Edit Feature Settings dialog box, expand Subassembly Name Templates. In the Create From Macro row, click the Value cell. Click  .
- 3 In the Name Template dialog box, in the Name field, highlight the <[Next Counter]> property.
- 4 In the Property Fields list, select Subassembly Side. Click Insert.

The Name field should contain the following formula:

<[Macro Short Name(CP)]> - (<[Subassembly Side]>)

TIP To display the subassembly name in the local language, use the <[Subassembly Local Name]> property in place of the <[Macro Short Name(CP)]> property.

- 5 Click OK twice.

Examine the updated subassembly naming convention

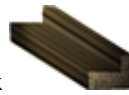

- 1 In the Tool Palettes window, click BasicCurbAndGutter.
- 2 In the Properties palette, under ADVANCED, set the Side to Right.
- 3 In the drawing, click the marker point at the top-right edge of the travel lane.

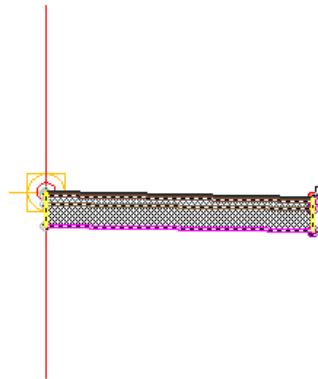

NOTE If you attach the subassembly to the wrong marker, you can move it to the correct location. Press Esc to exit subassembly placement mode. Select the subassembly you wish to move. A blue grip is displayed when the subassembly is selected. Select the grip, and then click the correct marker point.

- 4 In the Properties palette, under ADVANCED, set the Side to Left.

- 5 In the drawing, click the marker point at the top-left edge of the travel lane.
- 6 Press Esc.
- 7 In Toolspace, on the Prospector tab, select the Subassemblies collection. In the Toolspace list view, notice that there are two new subassemblies, BasicCurbAndGutter - (Left) and BasicCurbAndGutter - (Right). These names are more specific than those of the BasicLane subassemblies.

NOTE The next exercise demonstrates more best practices for assembly and subassembly naming in drawings that contain many corridor assemblies.

To continue this tutorial, go to [Exercise 3: Managing Assemblies and Subassemblies](#) (page 430).

Exercise 3: Managing Assemblies and Subassemblies

In this exercise, you will apply some assembly and subassembly management best practices to a drawing that contains multiple corridor assemblies.

The sample drawing contains several corridor assemblies. This exercise demonstrates how to name and label the assemblies so that they will be easy to manage.

In the sample drawing, several subassemblies are used multiple assemblies. For example, the LaneOutsideSuper subassembly is used in several assemblies. When they were created, the LaneOutsideSuper subassemblies all used the same naming template and a sequential number was appended to each name.

Performing the tasks demonstrated in this exercise will make it easy to manage assemblies and subassemblies in complex drawings.

For more information, see the AutoCAD Civil 3D Help topic *Understanding Subassemblies*.

Examine the assemblies

- 1 Open *Assembly-1c.dwg*, which is available in the [tutorial drawings folder](#) (page 819).
This drawing contains several completed corridor assemblies. The assemblies are designed to create an intersecting main and side road.
- 2 In Toolspace, on the Prospector tab, select the Assemblies collection.

In the Toolspace list view, notice that a specific name was assigned to the assemblies when they were created. The names describe the type of corridor, as well as the specific portion of the corridor to which they apply.

In the drawing, notice that each assembly has a label that corresponds to the assembly name. The labels are a simple AutoCAD MText components that make it easy to see the construction of the available assemblies.

- 3 On the command line, enter ZE.
The drawing zooms out to the drawing extents.
- 4 In Toolspace, on the Prospector tab, select the Main Road assembly. Right-click. Click Zoom To.
The drawing zooms to the Main Road assembly.

Assign specific names to subassemblies

- 1 In Toolspace, on the Prospector tab, select the Subassemblies collection.
In the Toolspace list view, notice that there are multiple versions of several subassemblies. For example, there are several BasicSideSlopeCutDitch - (Right) and BasicSideSlopeCutDitch - (Left) subassemblies. In the following steps, you will add the parent assembly name to each subassembly. The more descriptive name will make it easier to determine the parent assembly of each subassembly.
- 2 In the drawing, click the Main Road assembly baseline. Right-click. Click Assembly Properties.
- 3 In the Assembly Properties dialog box, on the Construction tab, expand the collections in the Item tree.
The subassemblies that comprise the assembly are displayed in the Item tree. Notice that the subassemblies are categorized into groups. Subassembly groups manage the order in which subassemblies are processed during corridor modeling. The first time you add a subassembly to an assembly, the subassembly is added to the first group. When you add a second subassembly by attaching it to the first subassembly, the second subassembly also gets added to the first subassembly group. The next time you select an assembly baseline, a new subassembly group is automatically created and subsequent subassemblies added to the assembly are added that group.
- 4 In the Item tree, click the LaneOutsideSuper - (Right) (1) subassembly.

The subassembly parameters are displayed in the Input Values panel. You can modify the parameters as necessary from this panel.

- 5 Click the LaneOutsideSuper - (Right) (1) subassembly again to highlight the text.
- 6 Replace the LaneOutsideSuper - (Right) (1) text with LaneOutsideSuper - (Right) Main Road. Press Enter.
- 7 Repeat Steps 4 through 6 to rename the other subassemblies:
 - UrbanCurbGutterValley1 - (Right) (1):UrbanCurbGutterValley1 - (Right) Main Road
 - LinkWidthAndSlope - (Right) (1): LinkWidthAndSlope - (Right) Main Road
 - BasicSideSlopeCutDitch - (Right) (1): BasicSideSlopeCutDitch - (Right) Main Road
 - LaneOutsideSuper - (Left) (1): LaneOutsideSuper - (Left) Main Road
 - UrbanCurbGutterValley1 - (Left) (1): UrbanCurbGutterValley1 - (Left) Main Road
 - LinkWidthAndSlope - (Left) (1): LinkWidthAndSlope - (Left) Main Road
 - BasicSideSlopeCutDitch - (Left) (1): BasicSideSlopeCutDitch - (Left) Main Road
- 8 Repeat Steps 4 through 6 to rename the subassembly groups:
 - Group - (1): Main Road Right
 - Group - (2): Main Road Left
- 9 Click OK.
- 10 In Toolspace, on the Prospector tab, select the Subassemblies collection. Notice that the subassembly names you specified are displayed in the Prospector list view.

Further exploration: Practice what you learned by renaming the subassemblies in the remaining assemblies.

To continue to the next tutorial, go to [Creating an Assembly with Conditions](#) (page 433).

Tutorial: Creating an Assembly with Conditions

This tutorial demonstrates how to use the ConditionalCutOrFill subassembly to build a corridor assembly that applies different subassemblies depending on the cut or fill condition at a given station.

Conditional subassemblies enable you to reduce the number of corridor regions and assemblies to maintain.

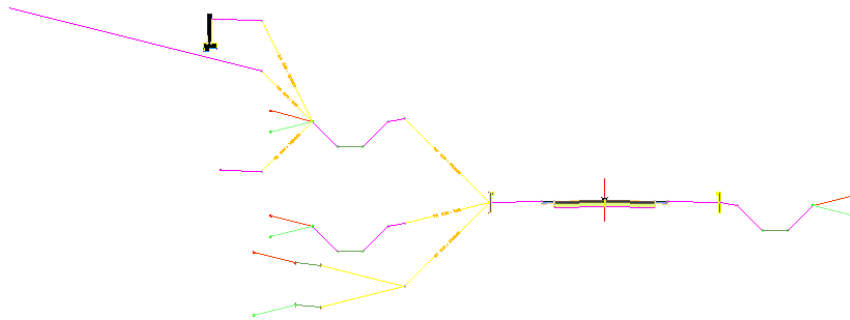

For more information, see the AutoCAD Civil 3D Help topic *Creating Assemblies with Conditional Subassemblies*.

Exercise 1: Examining the Existing Corridor in Section

In this exercise, you will examine how the daylight subassemblies are applied to the corridor model in section. You will notice stations at which the current daylighting parameters are inappropriate for the site conditions.

For more information, see the AutoCAD Civil 3D Help topic *Viewing and Editing Corridor Sections*.

Examine the existing corridor

- 1 Open *Assembly-2a.dwg*, which is available in the [tutorial drawings folder](#) (page 819).

The drawing contains two viewports. A completed corridor assembly is displayed in the top viewport. A surface, corridor, and profile view are displayed in the bottom viewport.

- 2 In the bottom viewport, select the corridor. Click Corridor tab ► Modify Corridor Sections panel ► Section Editor .

- 3 On the Section Editor tab, use the  buttons to examine how the Through Road assembly is applied to at the corridor stations. The assembly creates a ditch on either side of the road. At the beginning and end of the corridor, the cut and fill is relatively consistent on both sides.

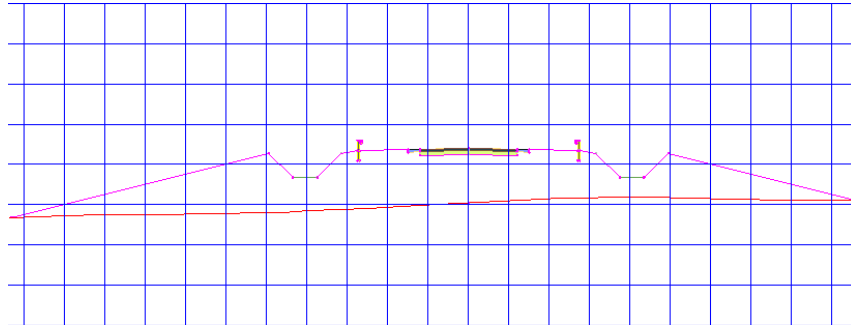

In the following exercises, you will address two conditions:

- First, the fill condition from stations 0+00 through 1+00 produces a relatively deep fill on the left side. While the corridor assembly is constructed appropriately for other regions of the corridor, you will modify the design to use a different approach in this region.

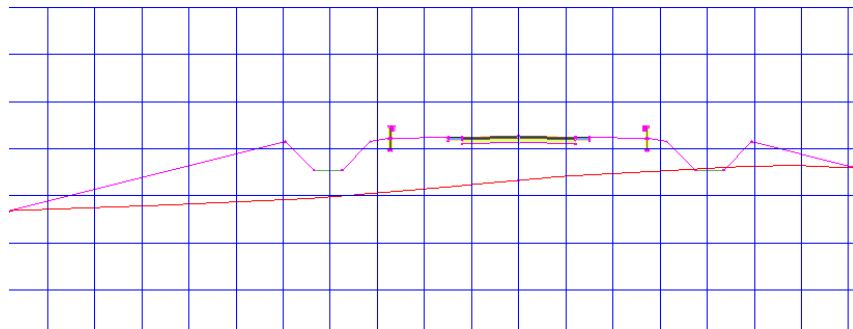

- Second, from stations 5+00 through 8+00, a much greater amount of material must be cut from the left side of the corridor. While the Through Road assembly is appropriate for most the corridor, it is not ideal for these stations.

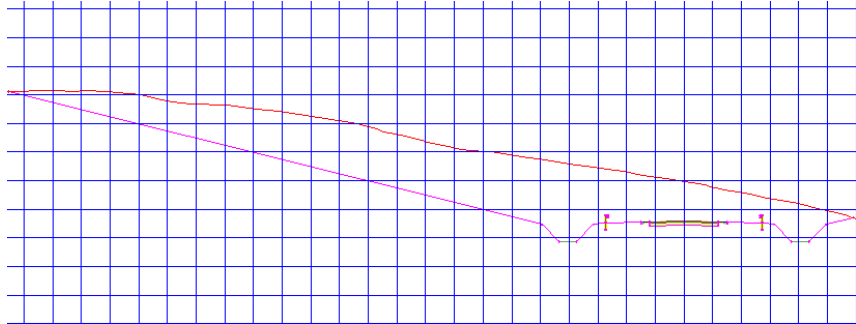

- 4 In the View/Edit Corridor Section Tools toolbar, click  to return to station 0+00.

To continue this tutorial, go to [Exercise 2: Adding Conditional Subassemblies to a Corridor Assembly](#) (page 435).

Exercise 2: Adding Conditional Subassemblies to a Corridor Assembly

In this exercise, you will add ConditionalCutOrFill subassemblies to an existing corridor assembly.

You will specify two levels of ConditionalCutOrFill subassemblies. In the first level, you will attach three ConditionalCutOrFill subassemblies to an existing guardrail subassembly, and then add standard daylight subassemblies to them:

- Cut: Add a ditch, and then daylight to surface at a 2:1 slope.
- Fill < 5.0000': Add a ditch, and then daylight to surface at a 8:1 slope.
- Fill > 5.0000': Add benching, and then daylight to surface at a 4.0:1 slope.

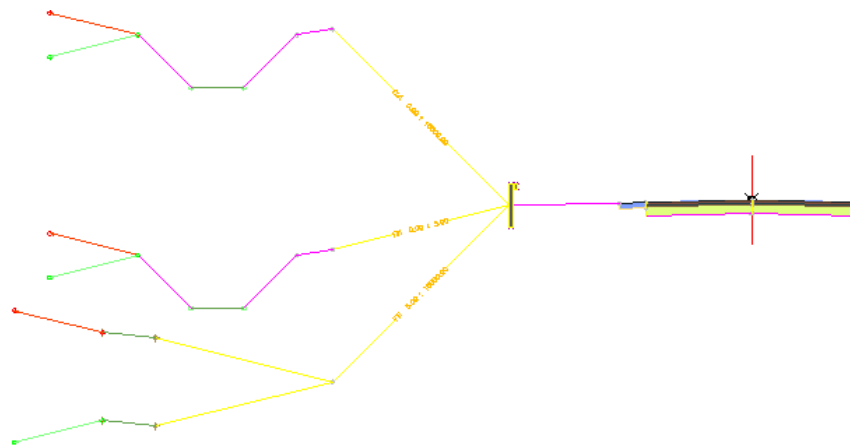

You will add a second level of ConditionalCutOrFill subassemblies to the ditch subassembly that is applied in cut conditions:

- Cut < 5.0000': Daylight to the surface at a point that is 60' from the baseline.
- Cut > 5.0000': Add a 12.0' daylight link at a -2.0% slope, and then add a retaining wall.
- Fill: Slope to surface at 4.0%.

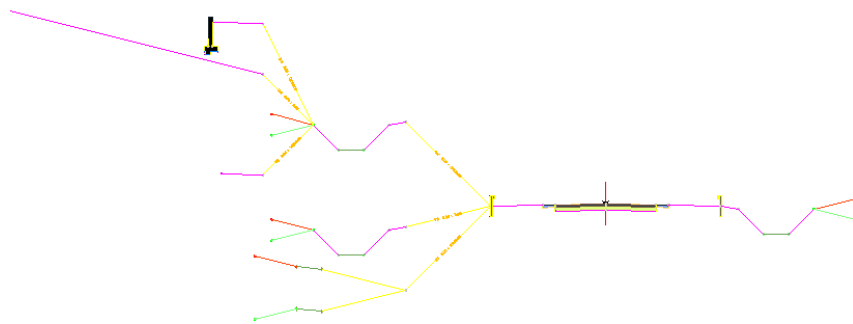

This exercise continues from [Exercise 1: Examining the Existing Corridor in Section](#) (page 433).

Add three conditional subassemblies

- 1 If the Tool Palette containing the subassemblies is not visible, click Home tab ► Palettes panel ► Tool Palettes .
- 2 In the tool palette, right-click the Tool Palettes control bar. Click Civil Imperial Subassemblies.
- 3 Click the Conditional tab.

- 4 Click  ConditionalCutOrFill.

- 5 In the Properties palette, specify the following parameters:

- Side: Left
- Layout Width: 20.0000'
- Layout Grade: 4.000:1
- Type: Fill
- Minimum Distance: 0.0000'
- Maximum Distance: 5.0000'

NOTE The Layout Width and Layout Grade parameters only affect the appearance of the subassembly in layout view. These parameters enable you to position the conditional subassembly and subassemblies that are attached to it, but do not affect the corridor model.

- 6 In the drawing, in the top viewport, click the left guardrail to add the ConditionalCutOrFill subassembly.

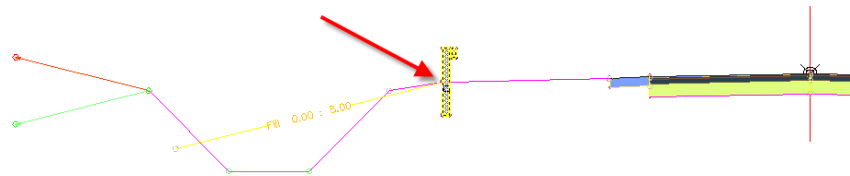

- 7 Add a second ConditionalCutOrFill subassembly to the left guardrail using the following parameters:
 - Side: Left

- Layout Width: 20.0000'
 - Layout Grade: 1.000:1
 - Type: Fill
 - Minimum Distance: 5.0001'
 - Maximum Distance: 10000.0000'
- 8 Add a third ConditionalCutOrFill subassembly to the left guardrail using the following parameters:
- Side: Left
 - Layout Width: 20.0000'
 - Layout Grade: 1.000:1
 - Type: Cut
 - Minimum Distance: 0.0000'
 - Maximum Distance: 10000.0000'

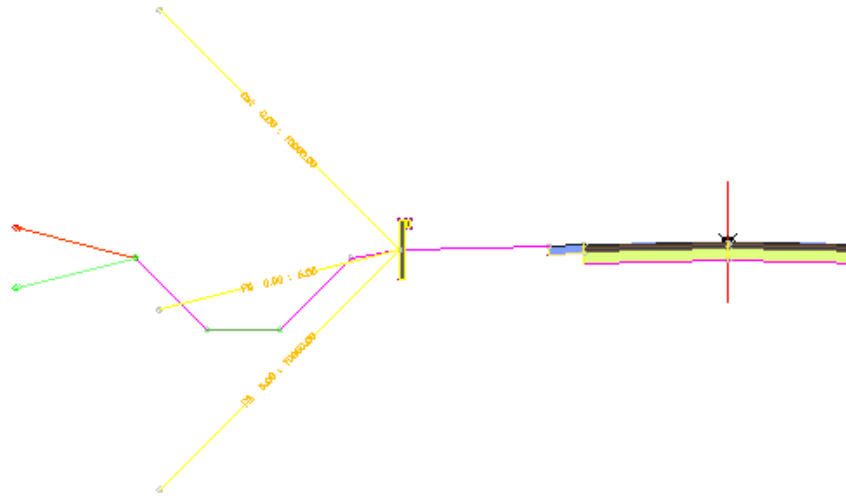

Add a daylight bench subassembly



- 1 Using the Daylight tool palette, add a DaylightBench subassembly to the Fill 5.00 : 10000.00 conditional subassembly using the following parameters:
 - Side: Left
 - Cut Slope: 4.000:1
 - Max Cut Height: 5.0000'
 - Fill Slope: 4.000:1
 - Max Fill Height: 5.0000'
 - Bench Width: 6.0000'
 - Bench Slope: -10.000%
- 2 Press Esc to exit subassembly placement mode.

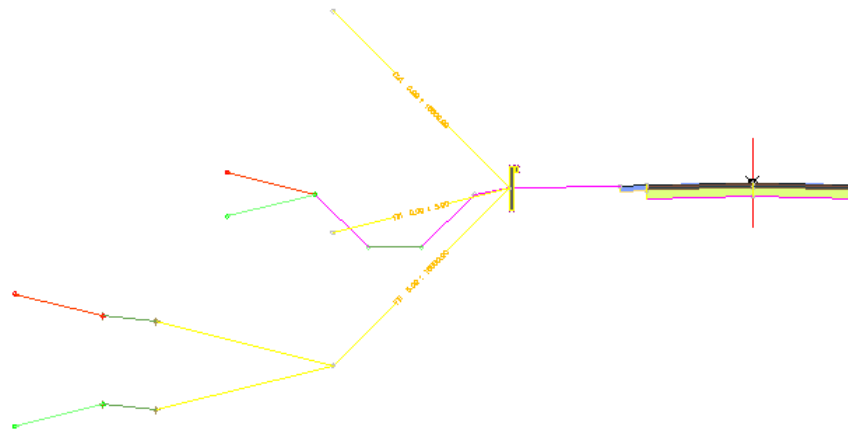

Move and copy the original daylight subassembly

- 1 Select the original left ditch subassembly. Right-click. Click Move To. Click the Fill 0.00 : 5.00 conditional subassembly.
- 2 Select the ditch subassembly that you just moved. Right-click. Click Copy To. Click the Cut 0.00 : 10000.00 conditional subassembly.

When you are finished, the assembly should look like this:

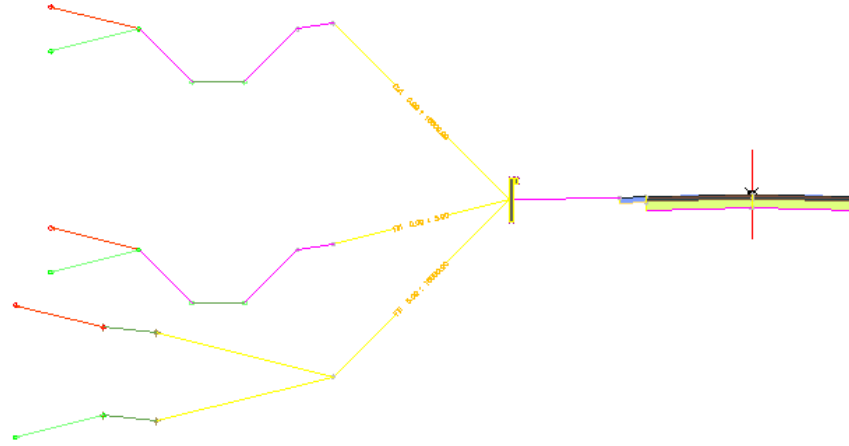

Add a second level of conditional subassemblies

- 1 Using the Conditional tool palette, add a  ConditionalCutOrFill subassembly to the hinge point on the daylight basin subassembly for the cut condition using the following parameters:
 - Side: Left
 - Layout Width: 12.0000'
 - Layout Grade: 0.500:1
 - Type: Cut
 - Minimum Distance: 5.0001'
 - Maximum Distance: 10000.0000'

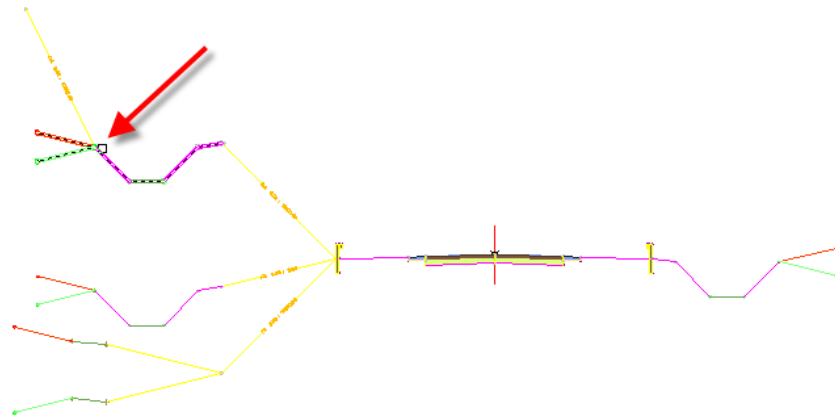

- 2 Add a second ConditionalCutOrFill subassembly to the hinge point on the daylight basin subassembly using the following parameters:
 - Side: Left
 - Layout Width: 12.0000'
 - Layout Grade: 1.000:1
 - Type: Cut
 - Minimum Distance: 0.0000'
 - Maximum Distance: 5.0000'

- 3 Add a third ConditionalCutOrFill subassembly to the hinge point on the daylight basin subassembly using the following parameters:
 - Side: Left
 - Layout Width: 12.0000'
 - Layout Grade: 1.000:1
 - Type: Fill
 - Minimum Distance: 0.0000'
 - Maximum Distance: 10000.0000'

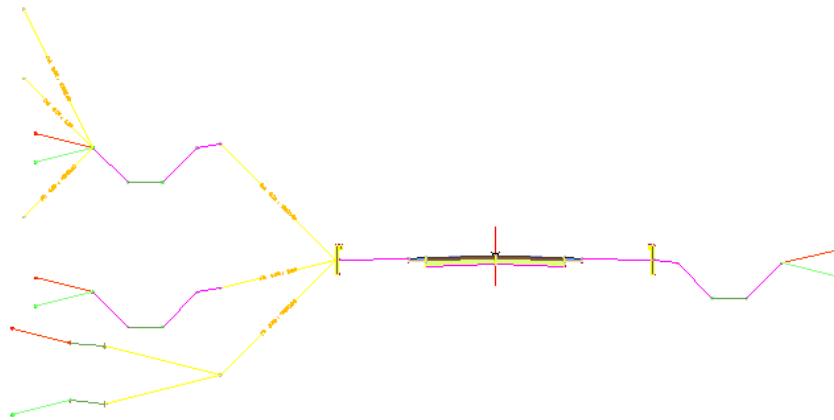

Add subassemblies to the second level



- 1 Using the Generic tool palette, add a **LinkWidthAndSlope** subassembly to the Cut 5.00 : 10000.00 conditional subassembly using the following parameters:
 - Side: Left
 - Width: 12.0000'
 - Slope: -2.000%



- 2 Using the Retaining Walls tool palette, add a **RetainWallVertical** subassembly to the LinkWidthAndSlope subassembly using the default parameters.



- 3 Using the Generic tool palette, add a **LinkOffsetOnSurface** subassembly to the Cut 0.00 : 5.00 conditional subassembly using the following parameters:
 - Offset From Baseline: -60.000'
 - Omit Link: No



- Using the Generic tool palette, add a `LinkSlopeToSurface` subassembly to the Fill 0.00 : 10000.00 conditional subassembly using the following parameters:
 - Side: Left
 - Slope: 4.000%
 - Add Link In: Fill Only

NOTE The Fill 0.00 : 10000.00 conditional subassembly that is attached to the cut branch of the assembly will be applied if the daylight basin subassembly were to end in a fill condition.

- Press Esc to exit subassembly placement mode.
When you are finished, the assembly should look like this:

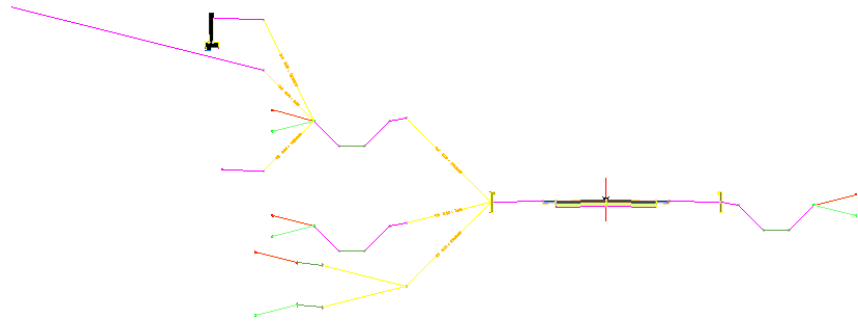

To continue this tutorial, go to [Exercise 3: Adjusting Conditional Subassembly Properties](#) (page 443).

Exercise 3: Adjusting Conditional Subassembly Properties

In this exercise, you will adjust the properties of one of the subassemblies, and then assign descriptive names to each of the subassemblies in the Through Road assembly.

Give each subassembly a specific, meaningful name to make it easy to identify when you are assigning targets. Meaningful names also help you identify subassemblies in the Subassemblies collection in Prospector.

This exercise continues from [Exercise 2: Adding Conditional Subassemblies to a Corridor Assembly](#) (page 435).

Omit the daylight link from the cut conditional subassemblies

NOTE This exercise uses *Assembly-2a.dwg* with the modifications you made in the previous exercise, or you can open *Assembly-2b.dwg* from the [tutorial drawings folder](#) (page 819).

- 1 In the top viewport, select the DaylightBasin subassembly that is attached to the Cut 0.00 : 10000.00 conditional subassembly. Right-click. Click Subassembly Properties.
- 2 In the Subassembly Properties dialog box, on the Parameters tab, for Daylight Link, set the Default Input Value to Omit Daylight Link. Click OK.

If you attach a ConditionalCutOrFill subassembly to a standard daylight subassembly, omit the daylight link in the host subassembly. If the daylight link is included in the host subassembly, then daylight links will be created for both the host subassembly and the attached subassembly.

Rename the subassemblies

- 1 In the top viewport, select the red assembly marker. Right-click. Click Assembly Properties.
- 2 In the Assembly Properties dialog box, click the Construction tab.
Notice that the subassemblies you added to the left side of the assembly display the default names followed by the side to which they were added. When you build a complex assembly, you should assign meaningful names to the subassemblies so that you can easily identify them when setting corridor targets. This is also a good practice when a drawing contains multiple assemblies.

For more information, see the [Managing Assemblies and Subassemblies](#) (page 430) exercise.

In the following steps, you will give the subassemblies more meaningful names.

- 3 In the Item list, select the ConditionalCutOrFill - Left subassembly. Click it again to highlight the text. Change the name to COND Fill 0-5 for TR-L.

A descriptive naming convention helps to distinguish between the many ConditionalCutOrFill subassemblies that are present:

- COND: Conditional
 - Fill: The specified condition
 - 0-5: The minimum and maximum distance values
 - TR: The parent subassembly of the ConditionalCutOrFill subassembly (TR = Through Road Left)
 - -L: The side of the baseline that the subassembly is on (L = Left)
- 4 Rename the other two ConditionalCutOrFill subassemblies to the following names:
 - ConditionalCutOrFill - Left (1): COND Fill 5-10000 for TR-L
 - ConditionalCutOrFill - Left (2): COND Cut 0-10000 for TR-L
 - 5 Rename the daylight subassemblies to reflect the cut or fill condition to which they apply:
 - DaylightBench - Left: Daylight Bench (Fill) for TR-L
 - DaylightBasin - Left: Daylight Basin (Fill) for TR-L
 - DaylightBasin - Left: Daylight Basin (Cut) for TR-L
 - 6 Name the second level of the subassemblies the following:

NOTE To save time, you may choose to skip this step. The sample drawing listed in the next exercise has all the subassemblies named appropriately.

- ConditionalCutOrFill - Left: COND Cut 0-10000 -- Cut 5-10000 for TR-L
- ConditionalCutOrFill - Left (3): COND Cut 0-10000 -- Cut 0-5 for TR-L
- ConditionalCutOrFill - Left (4): COND Fill 0-10000 -- Cut 0-10000 for TR-L
- LinkWidthAndSlope - Left: Daylight Width Slope (Cut 0-10000 -- Cut 5-10000) for TR-L

- RetainWallVertical - Left: Retaining Wall (Cut 0-10000 -- Cut 5-10000) for TR-L
- LinkOffsetOnSurface: Daylight Offset On Surface (Cut 0-10000 -- Cut 0-5) for TR-L
- LinkSlopeToSurface - Left: Daylight Slope To Surface (Cut 0-10000 -- Fill 0-10000) for TR-L

7 Click OK.

To continue this tutorial, go to [Exercise 4: Rebuilding the Corridor and Examining the Results](#) (page 446).

Exercise 4: Rebuilding the Corridor and Examining the Results

In this exercise, you will reset the corridor targets, rebuild the corridor, and then examine how the conditional subassembly affects the corridor model.

For more information, see the AutoCAD Civil 3D Help topic *Viewing and Editing Corridor Sections*.

This exercise continues from [Exercise 3: Adjusting Conditional Subassembly Properties](#) (page 443).

Set targets and rebuild the corridor

- 1 Open *Assembly-2c.dwg*, which is available in the [tutorial drawings folder](#) (page 819).
The drawing contains the corridor assembly that you designed in the previous three exercises.
- 2 In the drawing, click the Corridor - (1) corridor.
- 3 Click Corridor tab ► Modify Corridor panel ► Corridor Properties drop-down ► Corridor Properties .
- 4 In the Corridor Properties dialog box, on the Parameters tab, click Set All Targets.
- 5 In the Target Mapping dialog box, in the Object Name column, click <Click Here To Set All>.

- 6 In the Pick A Surface dialog box, click Existing Ground.
- 7 Click OK three times to close the dialog boxes and rebuild the corridor.

Examine the rebuilt corridor

- 1 In the View/Edit Corridor Section Tools toolbar, click  to return to station 0+00.

At the first few stations, the corridor is in a relatively deep fill condition. In [Exercise 2: Adding Conditional Subassemblies to a Corridor Assembly](#) (page 435), you attached the DaylightBench subassembly to the Fill 5.00: 10000.00 conditional subassembly. The fill condition at this station is greater than 5.0001', so the DaylightBench subassembly is applied.

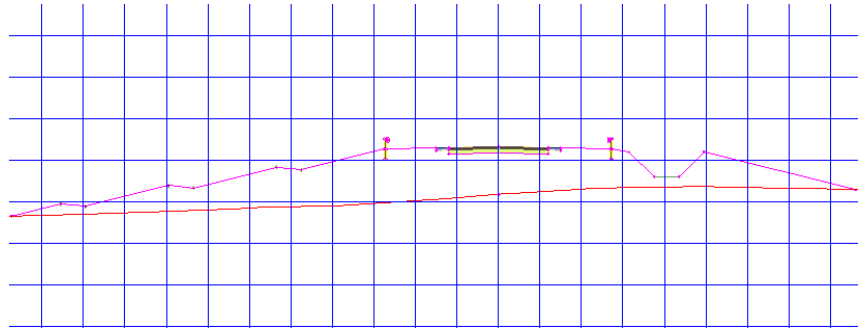

- 2 Click  eight times to advance to station 2+00.

Starting at station 2+00, the corridor enters a cut condition. At this station, the cut is less than 5.0000', so the DaylightOffsetToSurface subassembly is applied after the ditch.

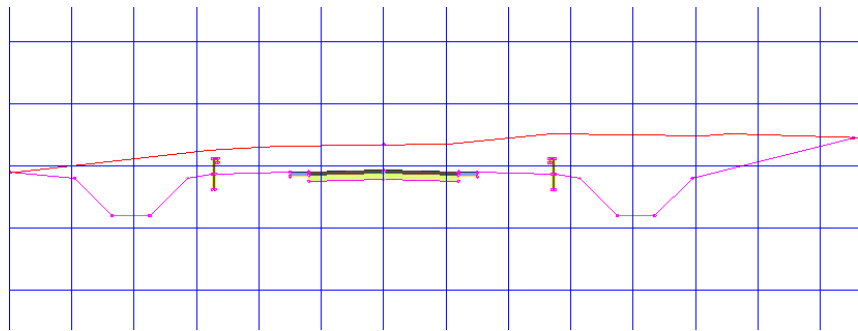

- 3 Click  again.

Starting at station 2+25, the cut condition is greater than 5.0001'. As you specified, the DaylightWidthSlope and RetainWallVertical subassemblies are applied after the ditch.

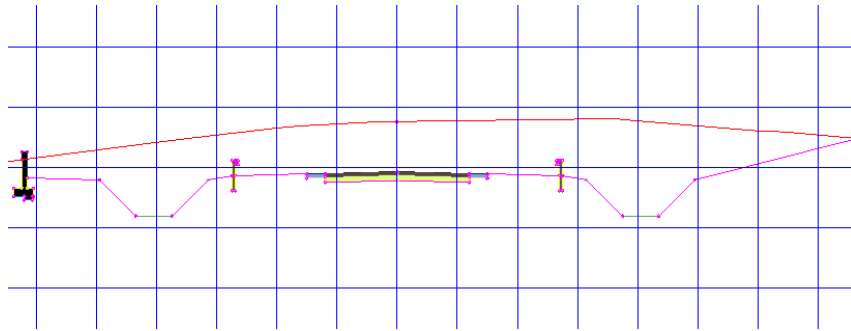

- 4 Continue using the   buttons to examine the cut and fill conditions along the corridor.

Further exploration: Apply what you learned to the right-hand side of the corridor assembly. Use different combinations of daylight subassemblies with the ConditionalCutOrFill subassembly and examine the results.

To continue to the next tutorial, go to [Saving and Sharing Corridor Assemblies](#) (page 448).

Tutorial: Saving and Sharing Corridor Assemblies

This tutorial demonstrates how to use AutoCAD Civil 3D to save commonly used corridor assemblies, and then share them with other users.

You can create an unlimited number of corridor assemblies, with either the subassemblies that are shipped with AutoCAD Civil 3D or custom subassemblies that you have created. You can save assemblies to a tool palette or catalog; either of these locations are convenient places to store commonly used assemblies available for reuse. You can also publish a tool palette or catalog to make it available for other users.

For more information, see the AutoCAD Civil 3D Help topic *Sharing Assemblies*.

Exercise 1: Saving Assemblies to a Tool Palette

In this exercise, you will create a tool palette, and then save the assemblies that are included in the sample drawing.

For more information, see the AutoCAD Civil 3D Help topic *Sharing Assemblies*.

Create a tool palette

- 1 Open *Assembly-3a.dwg*, which is available in the [tutorial drawings folder](#) (page 819).
This drawing contains an existing ground surface, and centerline alignments and polylines that define a proposed 50-ft right-of-way.
- 2 If the Tool Palette containing the subassemblies is not visible, click Home tab ► Palettes panel ► Tool Palettes .
- 3 In the tool palette, right-click the Tool Palettes control bar. Click Civil Imperial Subassemblies.
- 4 Right-click the Tool Palettes control bar. Click New Palette.
A new tool palette named New Palette is created.
- 5 Replace the New Palette name with Tutorial Assemblies.

Save assemblies to a tool palette

- 1 Zoom in to the assemblies on the right-hand side of the surface.

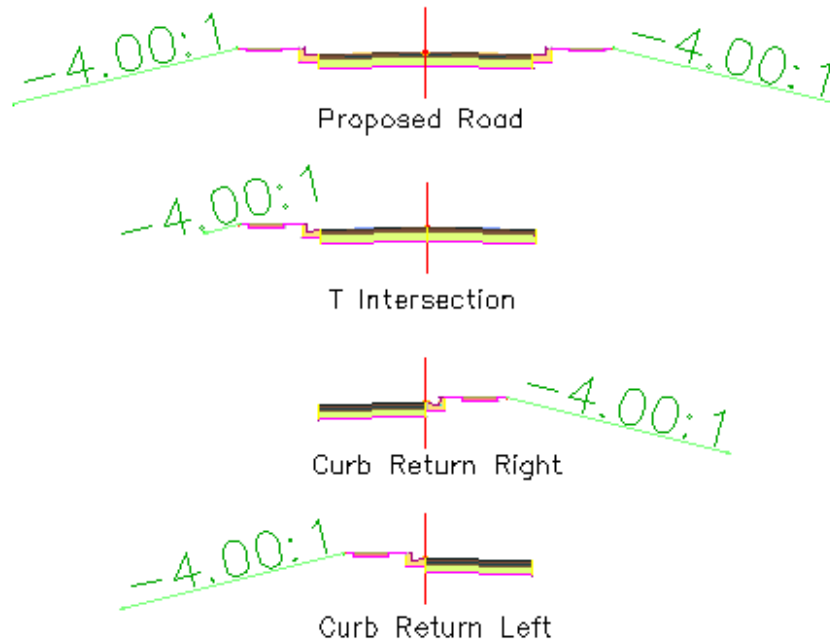

- 2 On the Proposed Road assembly, select the baseline.

NOTE Do not use the grips to drag the baseline marker.

- 3 Click the bottom of the baseline marker. Drag the baseline onto the Tutorial Assemblies tool palette.
The image and name of the assembly are displayed on the tool palette.
- 4 Repeat Steps 2 and 3 for the remaining three assemblies.
- 5 On the Tutorial Assemblies tool palette, right-click an empty area. Click View Options.
- 6 In the View Options dialog box, move the Image Size slider to the right to increase the size of the images on the tool palette. Click OK.
- 7 On the Tutorial Assemblies tool palette, hover the cursor over the Curb Return Left (CR-L) assembly.
Notice that a tooltip is displayed. The tooltip text is automatically generated from the description of the original assembly.

NOTE To see the original assembly description, right-click the assembly in Toolspace on the Prospector tab. Select Properties. The description appears in the Assembly Properties dialog box on the Information tab.

To continue this tutorial, go to [Exercise 2: Copying Assemblies to a Tool Catalog](#) (page 451).

Exercise 2: Copying Assemblies to a Tool Catalog

In this exercise, you will create a tool palette within a new tool catalog, and then add assemblies to it. After assemblies have been added to a tool catalog, you can share the tool catalog with other users.

TIP You can also use this procedure to copy assemblies from the drawing directly into a tool catalog.

For more information, see the AutoCAD Civil 3D Content Browser Help topics *Creating a New Tool Catalog* and *Adding a Tool Palette to a Tool Catalog*.

This exercise continues from [Exercise 1: Saving Assemblies to a Tool Palette](#) (page 449).

Create a tool catalog

1 Click Home tab ► Palettes panel drop-down ► Content Browser .

2 In the Autodesk Content Browser 2011 window, click .

3 In the Add Catalog dialog box, select Create A New Catalog.

4 Replace the New Catalog text with Residential Assemblies (Tutorial).

5 Click Browse.

6 In the Browse For Folder dialog box, examine the file path.

This is the default location where custom tool catalogs are saved. You will accept the default location for this tutorial.

7 Click OK twice.

8 In the Autodesk Content Browser 2011 window, right-click the Residential Assemblies (Tutorial) catalog. Click Properties.

- 9 In the Catalog Properties dialog box, double-click the Image rectangle.

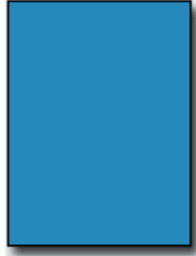

- 10 In the Select Image File dialog box, navigate to the [tutorial folder](#) (page 820). Select *Assembly_catalog_image.png*. Click **Open**.
- 11 In the Catalog Properties dialog box, click OK.

The image you selected is displayed in the Autodesk Content Browser 2011 window. Assigning an image to a tool catalog can make it easy to identify the tool catalog contents.

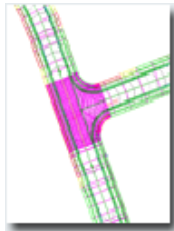

Create a tool palette in a tool catalog

- 1 In the Autodesk Content Browser 2011 window, click the Residential Assemblies (Tutorial) tool catalog.
The empty Residential Assemblies (Tutorial) tool catalog opens.

TIP To ensure that the Content Browser remains visible over the AutoCAD Civil 3D window, right-click the Autodesk Content Browser 2011 title bar and click Always On Top.

- 2 In the Autodesk Content Browser 2011 window, click .

- 3 In the Tool Palette Properties dialog box, specify the following parameters:
 - Name: 50-ft ROW Assemblies
 - Description: Corridor assemblies for residential subdivisions that require a 50-ft right-of-way
- 4 Click OK.

Add assemblies to a tool palette in a tool catalog

- 1 In the Autodesk Content Browser 2011 window, double-click the 50-ft ROW Assemblies tool palette.
- 2 In the AutoCAD Civil 3D window, click the Tutorial Assemblies tool palette. Press Ctrl+A to select all the assemblies on the palette.
- 3 Drag the assemblies into the 50-ft ROW Assemblies tool palette in the Residential Assemblies (Tutorial) tool catalog.



To continue this tutorial, go to [Exercise 3: Publishing a Tool Catalog](#) (page 453).

Exercise 3: Publishing a Tool Catalog

In this exercise, you will publish an assembly tool catalog so that it can be shared with other users.

For more information, see the AutoCAD Civil 3D Content Browser Help topic *Publishing Tool Catalogs*.

This exercise continues from [Exercise 2: Copying Assemblies to a Tool Catalog](#) (page 451).

- 1 In the Autodesk Content Browser 2011 window, click .
- 2 Right-click the Residential Assemblies (Tutorial) tool catalog. Click Publish 'Residential Assemblies (Tutorial)'.
- 3 In the Publish Tool Catalog dialog box, on the Step 1 Of 4 page, select Move It To A New Location. Click Next.
- 4 On the Step 2 Of 4 page, click . In the Move Catalog dialog box, navigate to the [My Civil Tutorial Data folder](#) (page 819). Click Make New Folder. Name the folder Assemblies Tutorial, and then click OK.

You can also specify a location on your company network. Publishing a tool catalog to a network location will allow multiple users to link to the tool catalog. If the tool catalog on the network changes, the users' catalog libraries will be automatically updated.

- 5 Click Next.
- 6 On the Step 3 Of 4 page, make sure that the dependant file path is the same location that you specified in Step 4. If it is not, click  to navigate to the correct path. Make sure that both check boxes on this page are selected.

Accepting the default options on this page will ensure that all the files that go with the tool catalog will be maintained in one central location.

- 7 Click Next.
- 8 On the Step 4 Of 4 page, make sure Directly From The Location Provided is selected.

This is the location that you specified in Step 4. The check boxes at the bottom of the page give you control over the interaction between the users' personal catalog libraries and the source tool catalog. Selecting the first check box prevents users from making unauthorized changes to the tool catalog. Selecting the second check box prevents the tool catalog contents from refreshing when they are dragged and dropped into the users' workspace.

- 9 Click Finish.
- 10 Using Windows Explorer, navigate to the *Assemblies Tutorial* folder on the Windows desktop.

The folder should contain the following files:

- *Images* folder
- *Palettes* folder
- *Residential Assemblies (Tutorial).atc*

To continue this tutorial, go to [Exercise 4: Installing a Tool Catalog](#) (page 454).

Exercise 4: Installing a Tool Catalog

In this exercise, you will add an assembly tool catalog to your personal Content Browser catalog library.

Before you install the tool catalog, you must remove the existing one that you created earlier. This will enable you to see how users would install a tool catalog that you created.

For more information, see the AutoCAD Civil 3D Content Browser Help topic *Adding an Existing Tool Catalog to Your Catalog Library*.

This exercise continues from [Exercise 3: Publishing a Tool Catalog](#) (page 453).

Delete the existing catalog from your Content Browser library

- 1 In the Autodesk Content Browser 2011 window, right-click the Residential Assemblies (Tutorial) catalog. Click Remove 'Residential Assemblies (Tutorial)' From Library.
- 2 In the Delete Catalog dialog box, click Yes.

Install the tool catalog

- 1 In the Autodesk Content Browser 2011 window, click  .
- 2 In the Add Catalog dialog box, select Add An Existing Catalog Or Web Site. Click Browse.
- 3 In the Browse For Catalog Files dialog box, [My Civil Tutorial Data folder](#) (page 819). Select *Residential Assemblies (Tutorial).atc*. Click Open.
- 4 In the Add Catalog dialog box, click OK.
A copy of the tool catalog is created in your personal catalog library.
- 5 Close *Assembly-3a.dwg*.

To continue this tutorial, go to [Exercise 5: Moving Assemblies from a Tool Catalog to a Tool Palette or Drawing](#) (page 455).

Exercise 5: Moving Assemblies from a Tool Catalog to a Tool Palette or Drawing

In this exercise, you will move assemblies from a tool catalog into a new drawing. Then, you will move a tool palette from Content Browser to the current tool palette group.

For more information, see the AutoCAD Civil 3D Content Browser Help topic *Using Tool Catalog Items in AutoCAD Civil 3D*.

This exercise continues from [Exercise 4: Installing a Tool Catalog](#) (page 454).

Move an assembly from Content Browser to a drawing

1 Click  ► New.

2 In the Select Template dialog box, select *_AutoCAD Civil 3D (Imperial) NCS.dwt*. Click Open.

3 In the Autodesk Content Browser 2010 window, open the Residential Assemblies (Tutorial) ► 50-ft ROW Assemblies tool palette.

4 Hover the cursor over the  icon below the **Proposed Road** assembly image.

Notice that the cursor changes to a  .

5 Click and hold the  icon. Drag the cursor into the drawing window and release the mouse button.

6 In an empty area in the drawing window, click to place the assembly. Press Esc to exit subassembly placement mode.

7 In the drawing window, select the baseline of the new assembly. Right-click. Click Assembly Properties.

8 In the Assembly Properties dialog box, on the Construction tab, notice that the subassemblies that make up the assembly have retained the naming convention that was specified in the original assembly. Click Cancel.

Add a tool palette from Content Browser to the current tool palette group

1 In the Autodesk Content Browser 2011 window, click  .

2 In the Catalog Library, click the Residential Assemblies (Tutorial) tool catalog.

- 3 Hover the cursor over the  icon next to the 50-ft ROW Assemblies tool palette.

Notice that the cursor changes to a  .

- 4 Click and hold the  icon. Drag the cursor onto the tool palette, and then release the mouse button.
The 50-ft ROW Assemblies tool palette and its contents are displayed in the current tool palette group.

Corridors Tutorials

13

These tutorials will get you started working with the corridor modeling tools, which are used to design and generate complex roadway corridor models.

If you have not installed AutoCAD Civil 3D to the default location, you may receive messages in the Event Viewer indicating that subassembly macro paths are not found. To avoid these messages, it is recommended that you follow the exercises in the order presented.

NOTE All drawings used in these tutorials are available in the [tutorial drawings folder](#) (page 819). If you want to save your work from these tutorials, save the drawings to the [My Civil Tutorial Data folder](#) (page 819) so that you do not overwrite the original drawings.

For more information, see the AutoCAD Civil 3D Help topic *Understanding Corridor Modeling*.

Tutorial: Creating a Basic Corridor Model

This tutorial demonstrates how to use AutoCAD Civil 3D objects to build a basic corridor model.

NOTE This tutorial uses the corridor assembly that you built in the [Creating an Assembly](#) (page 422) exercise.

A corridor model builds on and uses various AutoCAD Civil 3D objects and data, including subassemblies, assemblies, alignments, surfaces, and profiles.

Corridor objects are created along one or more baseline alignments by placing a 2D section (assembly) at incremental locations and creating matching slopes that reach a surface model at each incremental location.

For more information, see the AutoCAD Civil 3D Help topic *Creating Corridors*.

Specify the dependent objects

- 1 Open *Corridor-1a.dwg*, which is located in the [tutorial drawings folder](#) (page 819).
- 2 Click Home tab ► Create Design panel ► Corridor drop-down ► Create Corridor  .
- 3 When the 'Select baseline alignment' prompt is displayed, select the First Street alignment.

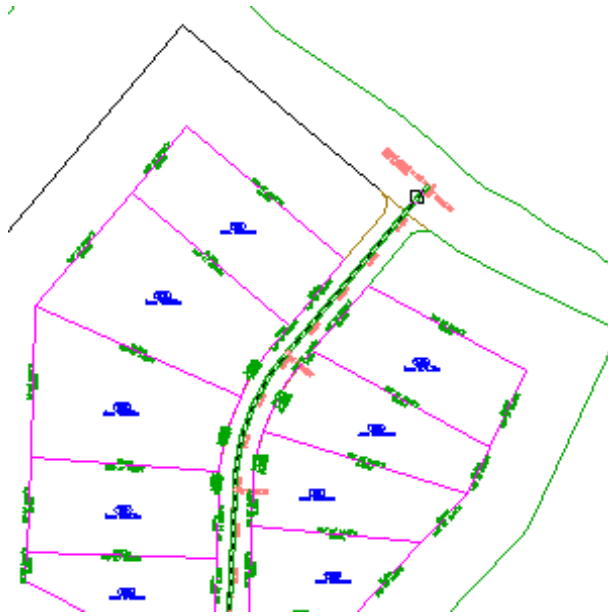

- 4 When the 'Select a profile' prompt is displayed, select the blue, Finished Grade Centerline - First Street profile.

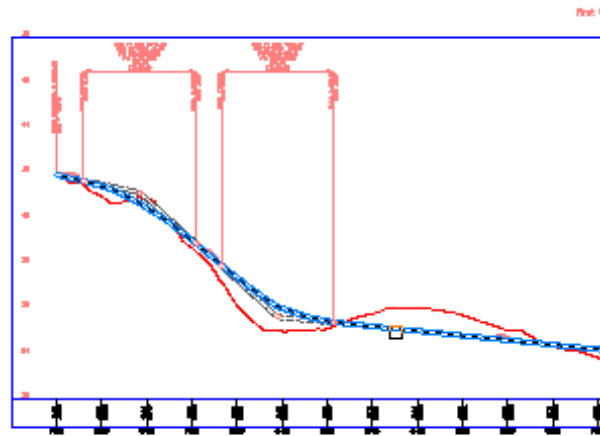

(Profile view grid lines removed for clarity)

- 5 When the 'Select an assembly' prompt is displayed, select the Primary Road Full Section assembly baseline.

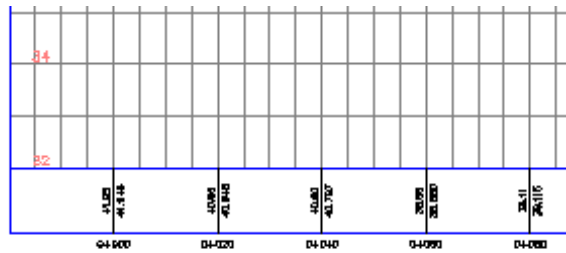

Specify the corridor parameters

- 1 In the Create Corridor dialog box, for Corridor Name, enter First Street.
- 2 In the RG-Primary Road Full Section - (1) row, in the End Station cell, enter 0+440.00.
- 3 In the Frequency cell, click  .
- 4 In the Frequency To Apply Assemblies dialog box, under Apply Assembly, for Along Curves, enter 3.000. Click OK.
- 5 In the Create Corridor dialog box, click Set All Targets.
In the Target Mapping dialog box, you can map logical names in subassemblies to actual objects in the drawing. For example, the BasicSideSlopeCutDitch subassembly requires that a surface be specified for calculating the daylight points.
- 6 In the table, in the Object Name column, click <Click Here To Set All>.
- 7 In the Pick A Surface dialog box, select surface EG.
This sets the daylight points for both the BasicSideSlopeCutDitch subassemblies to the same surface.

8 Click OK three times.

The corridor model is built and looks like this:

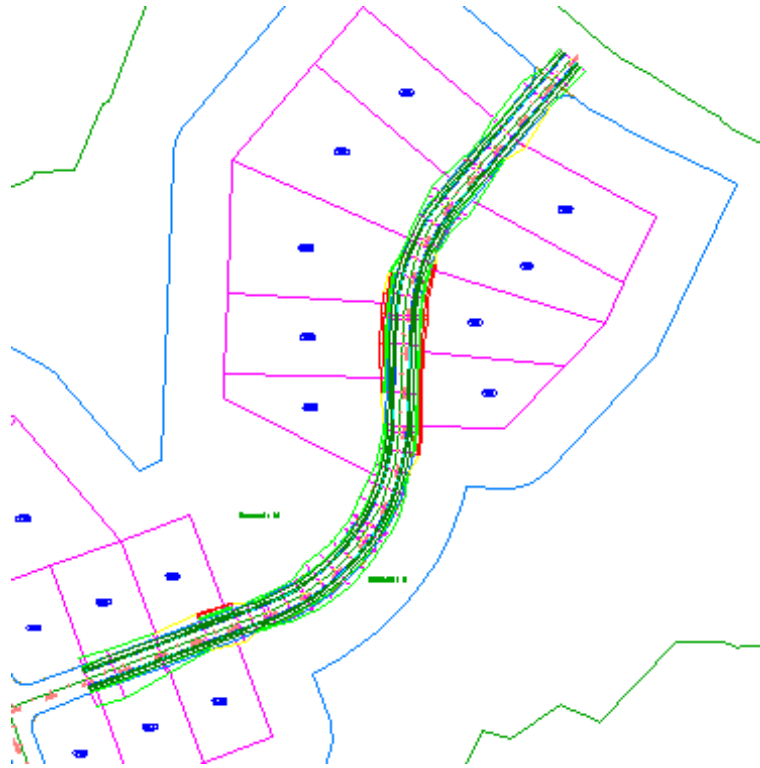

To continue to the next tutorial, go to [Creating a Corridor with a Transition Lane](#) (page 463).

Tutorial: Creating a Corridor with a Transition Lane

This tutorial demonstrates how to create a corridor with a transition lane. The tutorial uses some of the subassemblies that are shipped with AutoCAD Civil 3D to create an assembly. Then, you create a roadway where the travel lane widths and slopes are controlled by offset alignments, profiles, polylines, and feature lines.

For more information, see the AutoCAD Civil 3D Help topic *Assemblies and Subassemblies*.

Exercise 1: Creating an Assembly with a Transition Lane

In this exercise, you will create a corridor assembly with transitions.



For more information, see the AutoCAD Civil 3D Help topic *Creating Assemblies*.

Create an assembly baseline

- 1 Open *Corridor-2a.dwg*, which is available in the [tutorial drawings folder](#) (page 819).
- 2 Click Home tab ► Create Design panel ► Assembly drop-down ► Create Assembly .
- 3 In the Create Assembly dialog box, for Name, enter Transition. Click OK.
- 4 When the 'Specify assembly baseline location' prompt is displayed on the command line, click a point in the drawing to place the assembly. The viewport zooms to the assembly baseline, which looks like this:



Add a lane subassembly

- 1 If the Tool Palette containing the subassemblies is not visible, click Home tab ► Palettes panel ► Tool Palettes .
- 2 In the tool palette, right-click the Tool Palettes control bar. Click Civil Imperial Subassemblies.
- 3 Click the Basic tab.
- 4 Click  BasicLaneTransition.

- 5 In the Properties palette, under **ADVANCED**, specify the following parameters:
 - Side: Right
 - Default Width: 14.0000
 - Depth: 1.0000
 - Transition: Change Offset And Elevation
- 6 In the drawing, click the marker point on the assembly baseline.
A lane is drawn, extending 14 feet to the right, with a slope of -2% and a depth of 1 foot.

Add a curb and gutter subassembly

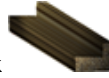

- 1 In the tool palette, click **BasicCurbAndGutter**.
- 2 In the Properties palette, under **ADVANCED**, specify the following parameters:
 - Side: Right
 - Gutter Width: 1.2500
- 3 In the drawing, click the marker point at the top-right edge of the lane to draw the curb and gutter.

Add a sidewalk subassembly

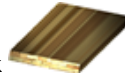

- 1 In the tool palette, click **BasicSidewalk**.
- 2 In the Properties palette, under **ADVANCED**, specify the following parameters:
 - Side: Right
 - Buffer Width 1: 2.0000
 - Buffer Width 2: 3.0000
- 3 In the drawing, click the marker point at the top back-side of the curb to add the sidewalk and its buffer zones.

Add a ditch subassembly



- 1 In the tool palette, click **BasicSideSlopeCutDitch**.
- 2 In the Properties palette, under ADVANCED, specify the following parameters:
 - Side: Right
 - Cut Slope: 3.000:1
- 3 In the drawing, click the marker point at the outside edge of the outer sidewalk buffer zone to add the cut-and-fill slope.

Add a transition lane subassembly



- 1 In the tool palette, click **BasicLaneTransition**.
- 2 In the Properties palette, under ADVANCED, specify the following parameters:
 - Side: Left
 - Default Width: 12.0000
 - Depth: 1.0000
 - Transition: Hold Grade, Change Offset
- 3 In the drawing, click the marker point on the assembly baseline. A lane is drawn, extending 12 feet to the left, with a slope of -2% and a depth of 1 foot.

Mirror the subassemblies outside the right lane

- 1 Press Esc to exit subassembly placement mode.
- 2 In the drawing, on the right-hand side of the assembly, select the curb, sidewalk, and daylight subassemblies. Right click. Click Mirror.
- 3 Click the marker point at the top-left edge of the transition lane to draw a mirror of the curb, sidewalk, and daylight subassemblies.
The subassemblies are displayed on the left side of the assembly marker.

The Mirror command creates a mirror image of the selected subassemblies. All the subassembly parameters, except for the Side parameter, are retained.

NOTE The parameters of the mirrored subassemblies are not dynamically linked. If you change a parameter value for a subassembly on one side of the assembly baseline, the change will not be applied to the opposite side.

The finished assembly looks like this:

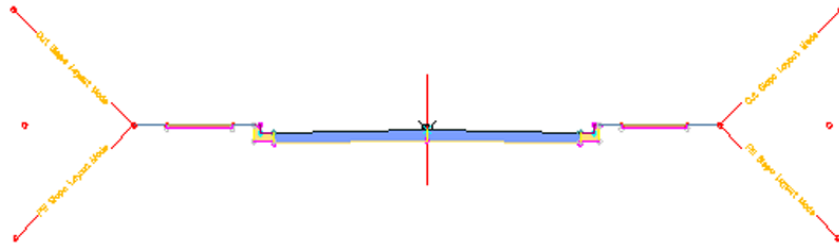

To continue this tutorial, go to [Exercise 2: Creating a Corridor with a Transition Lane](#) (page 467).

Exercise 2: Creating a Corridor with a Transition Lane

In this exercise, you will create a corridor using the assembly created in the last exercise. You will target the width and elevation of the right lane edge to a right alignment and profile, and the left lane edge to a polyline and a feature line.

For more information, see the AutoCAD Civil 3D Help topic *Creating Corridors*.

This exercise continues from [Exercise 1: Creating an Assembly with a Transition Lane](#) (page 464).

Specify the dependent objects

NOTE This exercise uses *Corridor-2a.dwg* from the previous exercise, or you can open *Corridor-2b.dwg* from the [tutorial drawings folder](#) (page 819).

- 1 Click Home tab ► Create Design panel ► Corridor drop-down ► Create Corridor  .
- 2 When the 'Select baseline alignment' prompt is displayed, press Enter.

- 3 In the Select An Alignment dialog box, select Centerline (1). Click OK.
- 4 When the 'Select a profile' prompt is displayed, press Enter.
- 5 In the Select A Profile dialog box, select Layout (1). Click OK.
- 6 When the 'Select an assembly' prompt is displayed, press Enter.
- 7 In the Select An Assembly dialog box, select Transition. Click OK.
The Transition assembly includes the BasicLaneTransition subassembly, which uses the Transition parameter to specify that both the offset and elevation can change on the right side of the corridor. The offset can change on the left side of the corridor but the grade is held at -2%.
- 8 In Create Corridor dialog box, for Corridor Name, enter Corridor - Transition Lanes.

Specify the daylight surface targets

- 1 Click Set All Targets.
- 2 In the Target Mapping dialog box, in the Object Name column, click <Click Here To Set All>.
- 3 In the Pick A Surface dialog box, select EG. Click OK.
This sets the daylight points for both the BasicSideSlopeCutDitch subassemblies to the same surface.

Specify the fixed lane horizontal target

- 1 In the Transition Alignment row for BasicLaneTransition - (Right), click the Object Name field.
- 2 In the Set Width Or Offset Target dialog box, specify the following parameters:
 - Select Object Type To Target: Alignments
 - Select Alignments: Right (1)
- 3 Click Add. Click OK.

Specify the transition lane horizontal target

- 1 In the Transition Alignment row for BasicLaneTransition - (Left), click the Object Name field.

- 2 In the Set Width Or Offset Target dialog box, in the Select Object Type To Target list, select Feature Lines, Survey Figures And Polylines.
- 3 Click Select From Drawing.
- 4 In the drawing, on the left side of the alignment, select the blue polyline and magenta feature line. Press Enter.

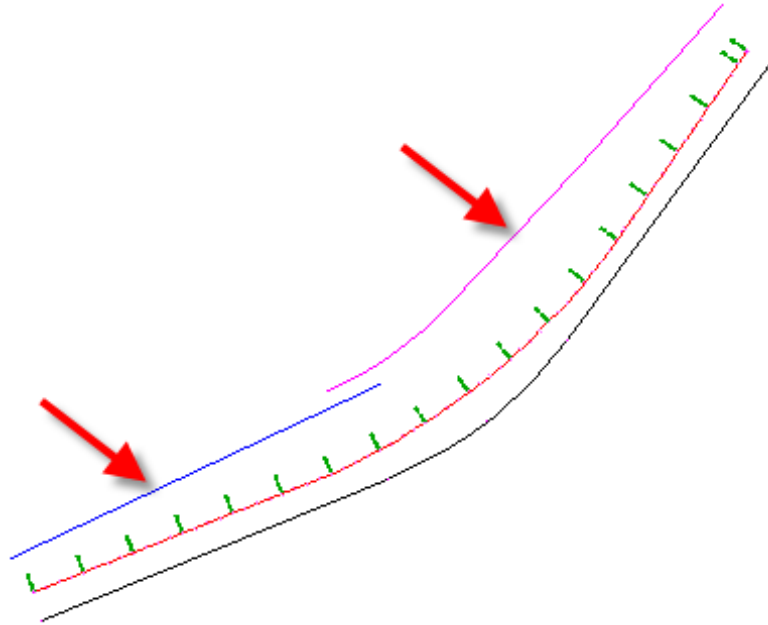

The entities are added to the table at the bottom of the Set Width Or Offset Target dialog box.

- 5 Click OK.
Notice that because the subassembly names contain the assembly side, it is easy to determine which assembly must target which offset object. This naming convention is even more useful in road designs that contain many alignments and subassemblies. For information on updating the subassembly naming template, see the [Modifying the Subassembly Name Template](#) (page 427) exercise.

Specify the transition lane elevation targets

- 1 In the Transition Profile row for BasicLaneTransition - (Right), click the Object Name field.

- 2 In the Set Slope Or Elevation Target dialog box, specify the following parameters:
 - Select Object Type To Target: Profiles
 - Select An Alignment: Right (1)
 - Select Profiles: Layout (1)
- 3 Click Add. Click OK.

The right-side edge-of-pavement elevation is set to the Layout (1) profile. The left-side edge-of-pavement elevation does not need to be set since its elevation is determined by the grade setting.
- 4 Click OK twice.

The corridor model is built, and looks like this:

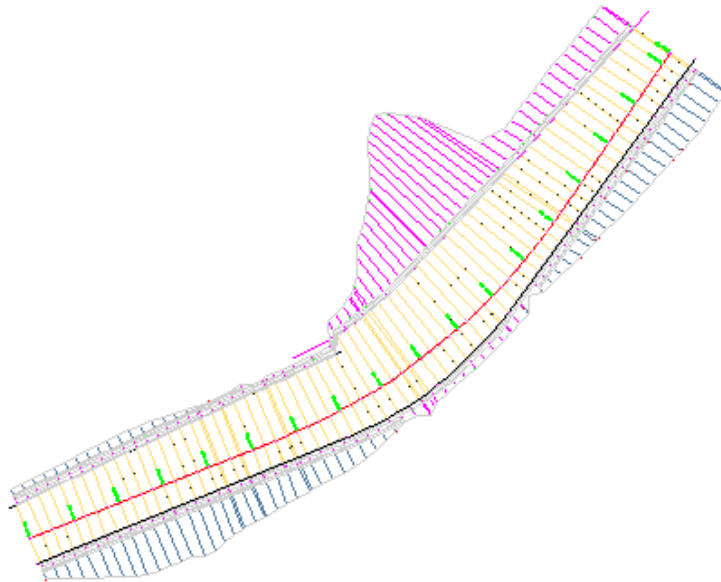

NOTE Notice that at station 7+50, the lane uses the polyline as a target, and not the feature line. When more than one target object is found at a station, the object that is closest to the corridor baseline is used as the target.

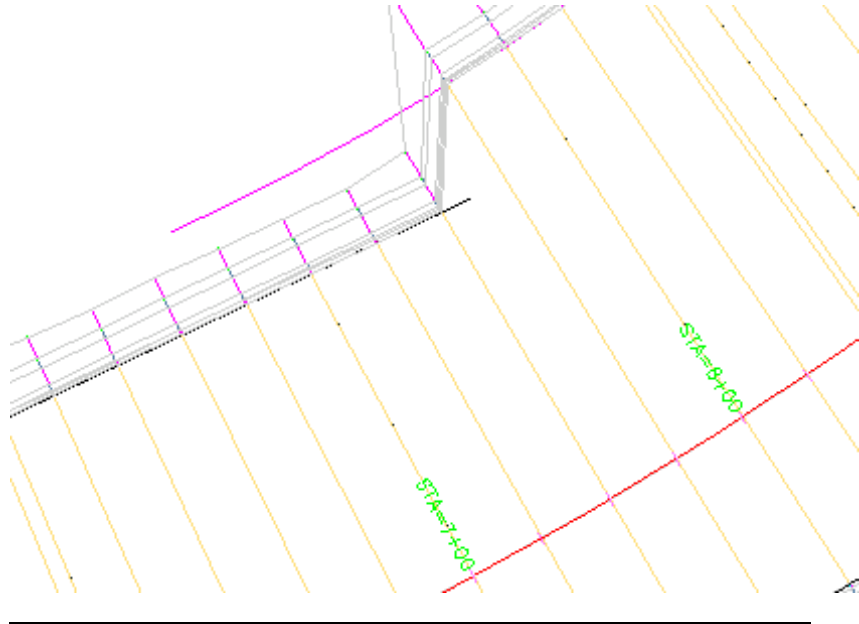

To continue to the next tutorial, go to [Creating a Divided Highway Corridor](#) (page 471).

Tutorial: Creating a Divided Highway Corridor

This tutorial demonstrates how to create a divided highway corridor. The tutorial uses some of the subassemblies that are shipped with AutoCAD Civil 3D to create a more complex and realistic highway model.

This highway has a depressed median with a flat bottom ditch and inside paved shoulders, two travel lanes on each side of the median, and paved outside shoulders. The total median width between inside edges-of-traveled-ways is 44 feet. The highway may have at-grade intersections, so the superelevation rotation point is set to be located at the design profile grade above the centerline of the median ditch. This creates a single consistent cross slope across the entire roadway in superelevated areas.

For more information, see the AutoCAD Civil 3D Help topic *Creating Corridors*.

Exercise 1: Creating a Divided Highway Assembly

In this exercise, you will create a fairly complex assembly with a depressed median and separated lanes.

For more information, see the AutoCAD Civil 3D Help topic *Creating Assemblies*.

Create an assembly baseline

- 1 Open *Corridor-3a.dwg*, which is available in the [tutorial drawings folder](#) (page 819).
- 2 Click Home tab ► Create Design panel ► Assembly drop-down ► Create Assembly .
- 3 In the Create Assembly dialog box, for Name, enter Divided Highway. Click OK.
- 4 When the 'Specify assembly baseline location' prompt is displayed on the command line, click a point in the drawing to build the assembly. The viewport zooms to the assembly baseline, which looks like this:

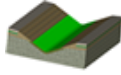

Add a median subassembly

- 1 If the Tool Palette containing the subassemblies is not visible, click Home tab ► Palettes panel ► Tool Palettes .
- 2 In the tool palette, right-click the Tool Palettes control bar. Click Civil Imperial Subassemblies.
- 3 Click the Medians tab.
- 4 Right-click  MedianDepressedShoulderExt. Click Help. Review the diagram to better understand the subassembly.

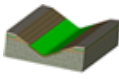
- 5 Click  MedianDepressedShoulderExt.
- 6 In the Properties palette, under ADVANCED, specify the following parameters:
- Centerline Pivot: Pivot about centerline
 - Left Median Width: 22.0000
 - Right Median Width: 22.0000
- 7 In the drawing, click the marker point on the assembly baseline. A depressed median and inside shoulders are drawn.

Add a lane subassembly

- 1 In the drawing, pan to the left edge of the MedianDepressedShoulderExt subassembly. Zoom in so that each marker point can be seen distinctly.
- 2 In the tool palette, click the Lanes tab.

- 3 Click  LaneOutsideSuper.
This subassembly inserts a travel lane that follows the outside lane superelevation slope for the superelevation properties of the alignment.

NOTE For more information about superelevation, see the [Applying Superelevation to an Alignment](#) (page 262) tutorial.

- 4 In the Properties palette, under ADVANCED, specify the following parameters:
- Side: Left
 - Width: 24.0000
- 5 In the drawing, click the marker that is at the top left edge of the median to insert the lane:

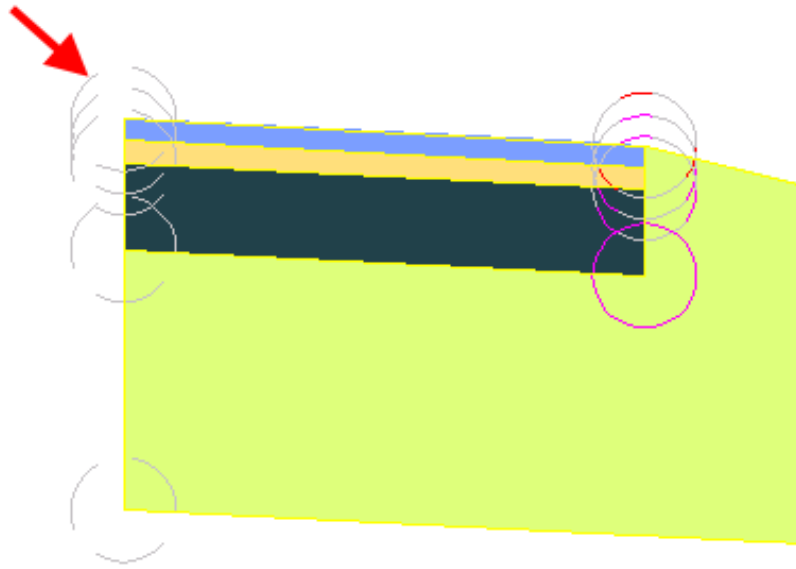

Add a shoulder subassembly

- 1 In the drawing, pan to the left side of the LaneOutsideSuper subassembly.
- 2 In the tool palette, click the Shoulders tab.



- 3 Click  ShoulderExtendSubbase.

- 4 In the Properties palette, under ADVANCED, specify the following parameters:
 - Side: Left
 - Use Superelevation Slope: Outside Shoulder Slope
 - Subbase - Use Superelevation: Outside Shoulder Slope

This sets these slopes to the outside shoulder superelevation slope. For more information, see the subassembly help.

- 5 In the drawing, click the marker point at the top outside edge-of-lane on finish grade to add the paved shoulder.

Add a daylight subassembly

- 1 In the drawing, pan to the left side of the ShoulderExtendSubbase.
- 2 In the tool palette, click the Daylight tab.
- 3 Right-click  DaylightStandard. Click Help. Review the diagram and Behavior section to better understand the cut and fill daylighting behaviors.
- 4 In the tool palette, click  DaylightStandard.
- 5 In the drawing, click the marker point at the outside edge of the ShoulderExtendSubbase subassembly to add the daylight slopes for cut and fill.

Mirror the subassemblies to the right side of the baseline

- 1 Press Esc to exit subassembly placement mode.
- 2 In the drawing, zoom out until you see the entire assembly. On the left-hand side of the assembly, select the daylight, shoulder, and lane subassemblies. Right click. Click Mirror.
- 3 Click the marker point at the top-right edge of the median subassembly to draw a mirror of the daylight, shoulder, and lane subassemblies. The Mirror command creates a mirror image of the selected subassemblies. All the subassembly parameters, except for the Side parameter, are retained.

NOTE The parameters of the mirrored subassemblies are not dynamically linked. If you change a parameter value for a subassembly on one side of the assembly baseline, the change will not be applied to the opposite side.

The finished assembly looks like this:

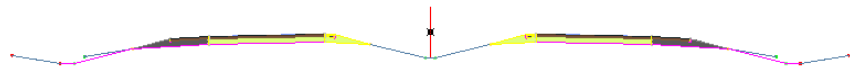

To continue this tutorial, go to [Exercise 2: Creating a Divided Highway Corridor](#) (page 476).

Exercise 2: Creating a Divided Highway Corridor

In this exercise, you will create a divided highway corridor.

For more information, see the AutoCAD Civil 3D Help topic *Creating Corridors*.

This exercise continues from [Exercise 1: Creating a Divided Highway Assembly](#) (page 472).

Specify the dependent objects

NOTE This exercise uses *Corridor-3a.dwg* from the previous exercise, or you can open *Corridor-3b.dwg* from the [tutorial drawings folder](#) (page 819).

- 1 Click Home tab ► Create Design panel ► Corridor drop-down ► Create Corridor .
- 2 When the 'Select baseline alignment' prompt is displayed, press Enter.
- 3 In the Select An Alignment dialog box, select Centerline (1). Click OK.
- 4 When the 'Select a profile' prompt is displayed, press Enter.
- 5 In the Select A Profile dialog box, select Layout (1). Click OK.
- 6 When the 'Select an assembly' prompt is displayed, press Enter.
- 7 In the Select An Assembly dialog box, select Divided Highway. Click OK.

Specify the daylight surface targets

- 1 In the Create Corridor dialog box, for Corridor Name, enter Divided Highway.
- 2 Click Set All Targets.
- 3 In the Target Mapping dialog box, click <Click Here To Set All>.
- 4 In the Pick A Surface dialog box, select EG.
- 5 Click OK three times.
- 6 Zoom to the extents of the corridor model.
The corridor model is built, and looks like this:

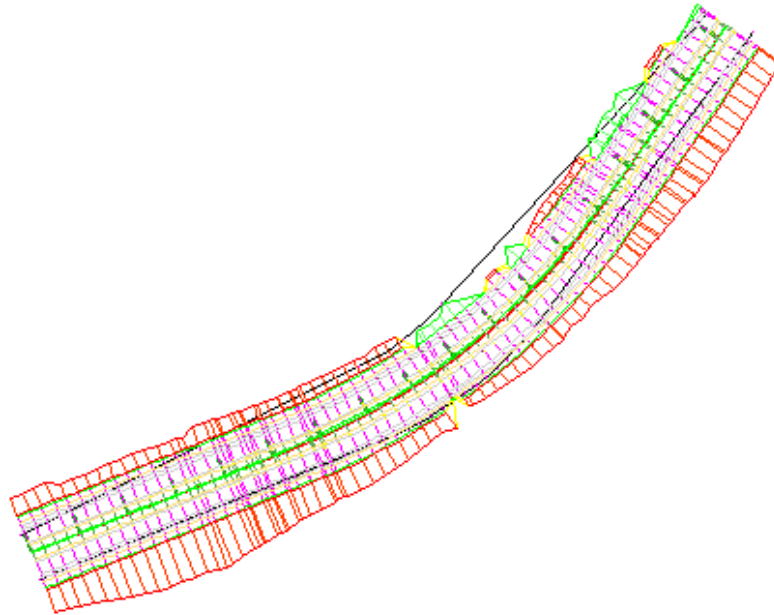

To continue to the next tutorial, go to [Viewing and Editing Corridor Sections](#) (page 477).

Tutorial: Viewing and Editing Corridor Sections

This tutorial demonstrates how to edit a corridor in section.

You use the tools that are demonstrated in this exercise to edit the corridor model. To plot corridor sections, you must create section views. See the [Sections Tutorials](#) (page 569) for more information.

For more information, see the AutoCAD Civil 3D Help topic *Viewing and Editing Corridor Sections*.

Exercise 1: Viewing Corridor Sections

In this exercise, you will view how a corridor assembly is applied at various stations along a baseline alignment.

The view/edit corridor section tools are useful for inspecting how the corridor assemblies interact with other objects in the corridor model.

For more information, see the AutoCAD Civil 3D Help topic *Viewing Corridor Sections*.

View a corridor in section

- 1 Open *Corridor-4a.dwg*, which is available in the [tutorial drawings folder](#) (page 819).

The drawing contains an assembly, profile view, and corridor model. Each object is displayed in a separate viewport. The viewport that contains the assembly is active.

- 2 Click Modify tab ► Design panel ► Corridor.
- 3 Click Corridor tab ► Modify Corridor Sections panel ► Section Editor .

- 4 On the Section Editor tab, on the Station Selection panel, in the Select A Station list, select 0+00.00.

A cross-section of the corridor at the starting station is displayed. The elevations and offsets are displayed on the grid axes. The cross section view contains the assembly, as well as the other adjacent objects.

At the current station, the offset alignments are represented by vertical green lines, and the existing ground surface is represented by the horizontal red line. The vertical red line in the center of the grid represents the assembly baseline. Profile intersections with the baseline are indicated

by  markers.

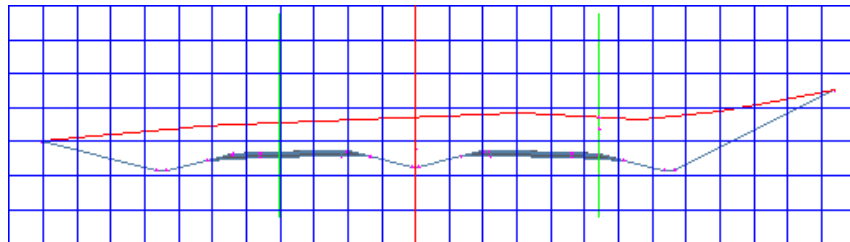



- 5 Use the tools on the Section Editor tab to view the corridor sections at each corridor station. Click  Go To Previous Station and  Go To Next Station, or select stations from the Select A Station list.



Notice that as each station is displayed on the grid, its location in the plan and profile viewports is identified by a perpendicular line.

Experiment with the zoom modes



- 1 Zoom in to the lane on the right-hand side of the assembly. Click  Go To Next Station.

Notice that the view zooms back out to the grid extents. There are three zoom modes in the view/edit corridor section tools. These modes control the behavior of the grid when you navigate to another station:

-  **Zoom To Extents**—View zooms out to the extents of the assembly, plus the view scale factor. This is the default zoom mode.
-  **Zoom To An Offset And Elevation**—View remains zoomed in on the current offset and elevation. As you navigate to other sections, the current offset and elevation remains at the center of the viewport.
-  **Zoom To A Subassembly**—View remains zoomed in on a selected subassembly. As you navigate to other sections, the selected subassembly remains at the center of the viewport.

- 2 In the Select A Station list, select 3+00.00.
- 3 On the View Tools panel, click  Zoom To Subassembly.
- 4 In the Pick Subassembly dialog box, select Daylight (Right). Click OK.
The view zooms in to the Daylight (Right) subassembly at station 3+00.00. Notice the shape, elevation, and offset of the subassembly.
- 5 In the Select A Station list, select 9+00.00.
The view zooms in to the Daylight (Right) subassembly at station 9+00.00. Notice that the shape, elevation, and offset of the subassembly is quite different from station 3+00.00. The subassembly remains at the center of the grid and at the same zoom factor as you navigate to other stations.
- 6 On the View Tools panel, click  Zoom To An Offset And Elevation.
- 7 Click  Go To Next Station several times.

Notice that the offset and elevation values that are displayed on the grid axes do not change. The shape of the Daylight (Right) subassembly changes to reflect how it ties in to the existing ground surface.

- 8 On the View Tools panel, click  Zoom To Extents.
- 9 Click  Go To Next Station.
The view zooms back out to the extents of the assembly.

To continue this tutorial, go to [Exercise 2: Editing Corridor Sections](#) (page 480).

Exercise 2: Editing Corridor Sections

In this exercise, you will edit the parameters at several corridor sections.



You will edit a section in two ways. First, you will modify a subassembly parameter at a single station, which will override the subassembly settings for that station only. Second, you will modify a subassembly parameter, and then apply the modification to a range of stations.

For more information, see the AutoCAD Civil 3D Help topic *Editing Corridor Sections*.

This exercise continues from [Exercise 1: Viewing Corridor Sections](#) (page 477).

Modify subassembly properties for a single station

NOTE This exercise uses *Corridor-4a.dwg* from the previous exercise.

- 1 On the Station Selection panel, in the Select A Station list, select 7+75.00.
- 2 On the View Tools panel, click  Zoom To A Subassembly.
- 3 In the Pick Subassembly dialog box, select Lane (Right). Click OK.
- 4 On the Corridor Edit Tools panel, toolbar, click  Parameter Editor.
- 5 In the Corridor Parameters dialog box, in the Assembly - (1) tree, under Group - (1), expand Lane (Right).

Notice that identical values are displayed in the Design Value and Value columns. The Design Value column displays the value that was specified when the subassembly was added to the assembly. The Value column displays the actual value of the subassembly at the current station. In the

following steps, you will override the Design Value at the current station, and then examine the results.

- 6 Change the Width Value to 36.0000'.
Notice that the Override check box is automatically selected, which indicates that the Design Value has been overridden at this station.
- 7 Click  Go To Next Station several times.
Notice that for the other stations, the Width Value is 12.000'. The lane subassembly that is displayed in the section view updates in width to reflect the width at the current station.
- 8 On the Station Selection panel, in the Select A Station list, select 7+75.00.
- 9 In the Corridor Parameters dialog box, in the Assembly - (1) tree, under Group - (1), under Lane (Right), in the Width row, clear the Override check box.
The Value column displays the same value as the Design Value column.

Modify subassembly properties for a range of stations

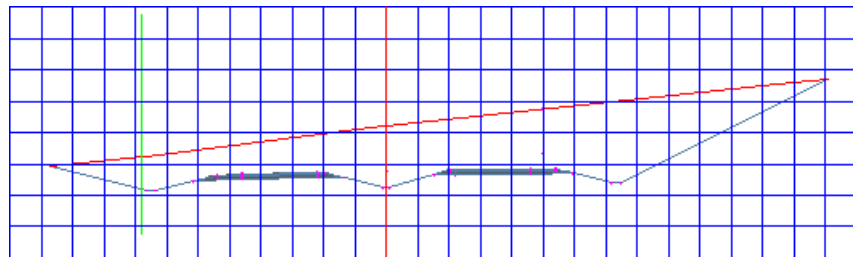

- 1 On the View Tools panel, click  Zoom To Extents.
- 2 On the Station Selection panel, in the Select A Station list, select 4+50.00.
Notice that the road is in a shallow cut on one side and deep cut on the other. The criteria set for the daylight subassembly caused it to use a 6:1 slope on the left side, and a 4:1 slope on the right side. Also notice the superelevation transition of the road. At station 4+50.00, the lanes are relatively flat.

NOTE For more information about superelevation, see the [Applying Superelevation to an Alignment](#) (page 262) tutorial.

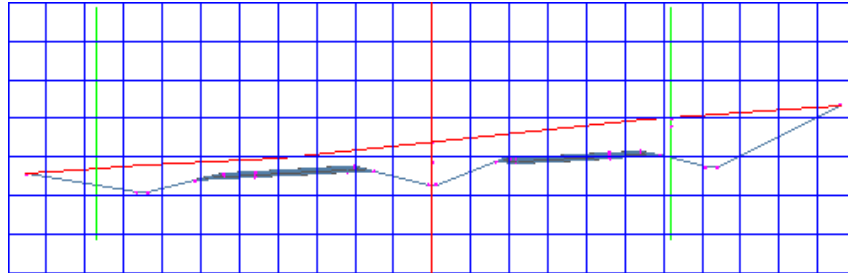

- 3 On the Station Selection panel, in the Select A Station list, select 7+75.00. Notice the superelevation transition at this station. Using the Centerline Pivot option on the depressed median subassembly causes the lanes and shoulders to superelevate about a point above the centerline ditch. A straight edge laid against the lane surfaces would pass through the profile grade point.



- 4 In the Corridor Parameters dialog box, in the Assembly - (1) tree, under Group - (1), expand Median. Notice that the Centerline Pivot Design Value is set to Pivot About Centerline.
- 5 In the Centerline Pivot? row, click the Value cell. Select Pivot About Inside Edge-Of-Traveled-Way.
- 6 On the Corridor Edit Tools panel, click  Apply To A Station Range.
- 7 In the Apply To A Range Of Stations dialog box, notice that Start Station is 7+75.00, which is the current station. For End Station, enter 11+00.00. Click OK.
- 8 On the Corridor Edit Tools panel, click  Update Corridor to update the corridor model.
- 9 View the corridor section at station 7+75.00. Notice that the profile grade is held at the inside edges-of-traveled-ways and the lanes and shoulders pivot about this point.

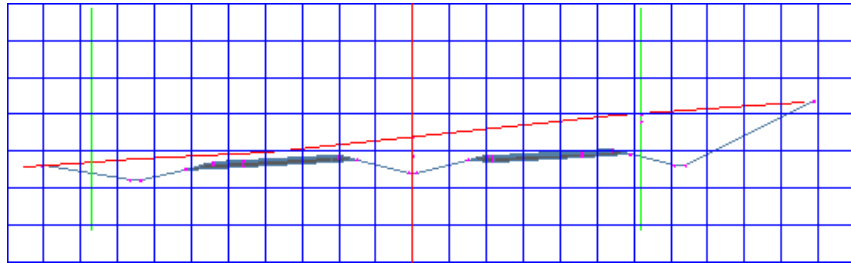

- 10 Click  Go To Next Station to view the grade at subsequent stations. Notice that the change you made is visible through station 11+00.00. At station 11+25.00, the Centerline Pivot? Value returns to Pivot About Centerline.

To continue to the next tutorial, go to [Viewing and Rendering a Corridor](#) (page 483).

Tutorial: Viewing and Rendering a Corridor

This tutorial demonstrates how to add surfaces to a corridor, create boundaries on the surfaces, and then visualize the corridor using the AutoCAD rendering tools.

For more information, see the AutoCAD Civil 3D Help topic *Managing and Editing Corridors*.

Exercise 1: Creating Corridor Surfaces

In this exercise, you will create Top, Datum, Pave, and Median surfaces from the corridor.

The Top surface tracks the finish grade of the roadway from the left daylight point to the right daylight point on both paved and unpaved portions. This surface is used for finish grade modeling.





The Datum surface tracks the finish grade on unpaved portions, and also the subbase on paved portions, going from the left daylight point to the right daylight point. This surface represents the grading elevations before pavement materials are applied. This surface is used for calculating cut and fill quantities.

The Pave surface defines the finished pavement on both travel lanes in the divided highway.

The Median surface defines the area between the travel lanes.

For more information, see the AutoCAD Civil 3D Help topic *Creating and Editing Corridor Surfaces*.

Create a top corridor surface

- 1 Open *Corridor-5a.dwg*, which is available in the [tutorial drawings folder](#) (page 819).
- 2 In the drawing, select the corridor.
- 3 Click Corridor tab ► Modify Corridor panel ► Corridor Surfaces .
- 4 In the Corridor Surfaces dialog box, click  Create A Corridor Surface to create an entry in the surfaces table.
- 5 Change the surface name to Corridor - (1) Top.
- 6 Click the Surface Style cell for the Corridor - (1) Top surface.
- 7 In the Pick Corridor Surface Style dialog box, select Border & Contours. Click OK.
- 8 Click the Render Material cell for the Corridor - (1) Top surface.
- 9 In the Pick Render Material dialog box, select Sitework.Paving - Surfacing. Asphalt. Click OK.
- 10 Select the Corridor - (1) Top surface by clicking the  icon next to its name.
- 11 Change the Overhang Correction setting to Top Links.
This setting specifies that the surface will be built using the links along the top of the assembly. This setting is especially critical when an assembly has overlapping subassembly links that, if connected, would result in errors in surface triangulation.
- 12 For Specify Code, select Top. Click  Add Surface Item.
This action adds the corridor links with the Top code to this surface.

Create a datum corridor surface

- Repeat the previous procedure to create a Datum surface, using these parameters:
 - Name: Corridor - (1) Datum
 - Surface Style: Hide Surface
 - Render Material: Sitework.Planting.Soil
 - Overhang Correction: Bottom Links
 - Link Code: Datum

Create a pave corridor surface

- Create a Pave surface, using these parameters:
 - Name: Corridor - (1) Pave
 - Surface Style: Border & Contours
 - Render Material: Sitework.Paving - Surfacing Asphalt
 - Overhang Correction: Top Links
 - Link Code: Pave

Create a median corridor surface

- Create a Median surface, using these parameters:
 - Name: Corridor - (1) Median
 - Surface Style: Border & Contours
 - Render Material: Sitework.Planting.Gravel.Mixed
 - Overhang Correction: Top Links
 - Link Code: Gravel

Generate the surfaces and examine the results

- 1 Click OK to create the surfaces and close the Corridor Surfaces dialog box.
- 2 In Toolspace, on the Prospector tab, expand the Surfaces collection.

Notice that the corridor surfaces you created have been added to the Surfaces collection. You can work with a corridor surface the same way you do with any surface in the Surfaces collection, including changing its style, adding labels to it, and using it for surface analysis. The following features and behaviors are unique to corridor surfaces:

- When you select a corridor surface, only the surface is selected. The corridor it is based on is not selected.
- When you change the surface style of a corridor surface using its surface properties, the style is also changed in the Corridor Properties dialog box on the Surfaces tab.
- When a corridor is rebuilt, corridor surfaces are updated to reflect any changes in the corridor, and then any edits are applied to the corridor model.
- The corridor from which the surface was taken is listed in the surface properties definition.

To continue this tutorial, go to [Exercise 2: Creating Corridor Surface Boundaries](#) (page 486).

Exercise 2: Creating Corridor Surface Boundaries

In this exercise, you will use two different methods to define surface boundaries for your corridor design.

Use corridor surface boundaries to prevent triangulation outside of the daylight lines of a corridor surface. You may also use boundaries to either prevent an area of a surface from being displayed or to render an area of the corridor surface using a render material.

Corridor surfaces support the following types of boundaries:

- Outside Boundary — Used to define the outer boundary of the corridor surface.
- Hide Boundary — Used as a mask to create void areas or punch holes in the corridor surface. For example, a corridor might use a link code Paved either side of the corridor with another surface (a median), separating them. When you create a corridor surface using Paved as the data, AutoCAD Civil 3D tries to connect the gap in between two link codes. To create voids, you define boundaries to represent the surface appropriately.

- **Render Only** — Used to represent different parts of corridor surface with different materials (when rendering), for example, asphalt and grass.

NOTE A Corridor Extends As Outer Boundary command is available for corridors that have multiple baselines, such as a corridor at an intersection.

For more information, see the AutoCAD Civil 3D Help topic *Adding and Editing Corridor Boundaries*.

This exercise continues from [Exercise 1: Creating Corridor Surfaces](#) (page 483).

Create outside boundaries automatically

- 1 Open *Corridor-5b.dwg*, which is available in the [tutorial drawings folder](#) (page 819).
- 2 In the drawing, select the corridor.

TIP If you have difficulty selecting the corridor in the drawing, go to Toolspace on the Prospector tab. Expand the Corridors collection. Right-click the corridor name and click Select.

- 3 Click Corridor tab ► Modify Corridor panel ► Corridor Surfaces .
- 4 In the Corridor Surfaces dialog box, click the Boundaries tab.
Four corridor surfaces are displayed in the boundary table.
- 5 Select the Corridor - (1) Top surface. Right-click. Click Add Automatically ► Daylight.
This creates a boundary from the daylight lines that are generated from the daylight point codes in the subassembly.

NOTE A Corridor Extends As Outer Boundary command is available for corridors that have multiple baselines, such as a corridor at an intersection.

- 6 Select the Corridor - (1) Datum surface. Right-click. Click Add Automatically ► Daylight.
- 7 For both boundaries, make sure the Use Type is set to Outside Boundary.
The daylight line in the corridor model is created at the points where the design surface matches the existing ground on each side. By selecting Outside Boundary, the surface will be clipped outside the boundary formed by the left and right daylight lines.

8 Click OK.

The new boundaries are added to the Corridor - (1) Top and Corridor-(1) Datum surfaces. The corridor model is regenerated and the surfaces are rebuilt.

These surface boundaries are defined by a pair of feature lines. When there are more than two of a given type of feature lines, then you must use the interactive method to use them to define a boundary.

For example, you were able to automatically create a surface boundary for the daylight region because there is a single pair of Daylight feature lines that define the daylight edges of the corridor assembly.

By contrast, the assembly has two lanes, each of which are defined by its own pair of EPS feature lines. In this case, you must define the boundary interactively.

Create a pave outside boundary interactively

This boundary will define the outside edges of both lanes by using the lanes' outer EPS feature lines. This will be an outside boundary to define the outside edges of the Corridor - (1) Pave surface.

- 1** Click View tab ► Views panel ► Named Views list ► Corridor_Begin.
The drawing is redrawn to a zoomed-in view of the starting area of Corridor (1).
- 2** In the drawing, select the corridor.
- 3** Click Corridor tab ► Modify Corridor panel ► Corridor Surfaces .
- 4** In the Corridor Surfaces dialog box, on the Boundaries tab, select the Corridor - (1) Pave surface. Right-click. Click Add Interactively.
- 5** In the drawing, select the feature line along the left-inside edge of the paved shoulder within circle 3.
- 6** Since there are multiple feature lines at this location, the Select A Feature Line dialog box is displayed. Select EPS. Click OK.
- 7** Pan to the other end of the corridor. Notice that a red line appears along the first feature line you selected.
- 8** Select the feature line in circle 10.
- 9** In the Select A Feature Line dialog box, select EPS. Click OK.

- 10 Pan to the beginning of the corridor, and select the feature line along right-inside edge of paved shoulder within circle 4.
- 11 On the command line, enter C to close the boundary.
- 12 In the Corridor Surfaces dialog box, expand the Corridor (1) – Pave surface collection item to see the boundary item. Change the corridor boundary name to Pave Outside and set its Use Type to Outside Boundary.

Create a hide boundary interactively

This boundary will define the inside edges of both lanes by using the lanes' inner EPS feature lines. This will be a *hide boundary* and will act as a mask over the median area of the Corridor - (1) Pave surface.

- 1 In the Corridor Surfaces dialog box, on the Boundaries tab, select the Corridor - (1) Pave surface. Right-click. Click Add Interactively
- 2 Repeat the previous procedure to define the inside boundary of the paved region:
 - Click in circle 1 and select EPS to define the left-outside edge of the paved shoulder.
 - Click in circle 8 and select EPS to define the left-outside edge of the paved shoulder.
 - Click in circle 2.
 - On the command line, enter C to close the boundary.
 - Change the name of the boundary to Pave Inside.
 - Change the Use Type to Hide Boundary.

Create a median outside boundary interactively

This boundary will define the outside edges of the median area using the lanes' inner EPS feature lines. This will be an *outside boundary* to define the outside edges of the Corridor - (1) Median surface.

- 1 In the Corridor Surfaces dialog box, on the Boundaries tab, select the Corridor - (1) Median surface. Right-click and click Add Interactively
- 2 Define the outside boundary of the median:
 - Click in circle 1 and select EPS to define the left-outside edge of the paved shoulder.

- Click in circle 8 and select EPS to define the left-outside edge of the paved shoulder.
 - Click in circle 2.
 - On the command line, enter C to close the boundary.
 - Change the name of the boundary to Median.
 - Change the Use Type to Outside Boundary.
- 3 Click OK to create the boundaries and close the Corridor Properties dialog box.

To continue this tutorial, go to [Exercise 3: Visualizing a Corridor](#) (page 490).

Exercise 3: Visualizing a Corridor

In this exercise, you will visualize the corridor using the rendering and hatching features in AutoCAD Civil 3D.

Rendering a corridor requires that you assign an AutoCAD *render material* to each of the appropriate subassembly links. Rendering produces a realistic image of the corridor that is useful for on-screen presentations.

Applying *hatching* to a corridor requires that you apply a *material area fill style* to each of the appropriate subassembly links. Hatching produces a less realistic image of the surface than rendering, but hatching prints easily through AutoCAD.

For more information, see the AutoCAD Civil 3D Help topic *Rendering Corridor Models*.

This exercise continues from [Exercise 2: Creating Corridor Surface Boundaries](#) (page 486).

Apply 3D render materials to a corridor

- 1 Open *Corridor-5c.dwg*, which is available in the [tutorial drawings folder](#) (page 819).
- 2 In the drawing, select the corridor.

TIP If you have difficulty selecting the corridor in the drawing, go to the Toolspace Prospector tab. Expand the Corridors collection. Right-click the corridor name and click Select.

First, you will apply render materials to the corridor link codes.

- 3 Click Corridor tab ► Modify Corridor panel drop-down ► Edit Code Set Styles.
- 4 On the Edit Code Sets dialog box, under Code Set Style, make sure that All Codes is selected.
In the Render Material column, examine the materials that are set for the links that are included in the subassemblies for the current corridor. These materials will be displayed on each link when you render the corridor model:
 - Daylight_Cut: Sitework.Planting.Grass.Short
 - Daylight_Fill: Sitework.Planting.Grass.Short
 - Ditch: Sitework.Planting.Grass.Thick
 - Gravel: Sitework.Planting.Gravel.Mixed
 - Median: Sitework.Planting.Grass.Short
 - Pave: Sitework.Paving - Surfacing.Asphalt
 - Slope_Link: Sitework.Planting.Grass.Short
- 5 Click OK.

Hide and render corridor surfaces

- 1 Click View tab ► Views panel ► Named Views list ► Corridor_3D View.
The drawing is redrawn to a three-dimensional view of the corridor.
- 2 In Toolspace, on the Prospector tab, expand the Surfaces collection.
- 3 Right-click the Corridor - (1) Median surface. Click Surface Properties.
- 4 In the Surface Properties dialog box, on the Information tab, change the Surface Style to Hide Surface. Click OK.
The Hide Surface style has all of its components turned off, which allows the surface's render material to be effectively ignored. The rendering method used in this exercise applies render materials that are assigned to the subassembly link codes, and not the surface itself.
- 5 Follow steps 2 and 3 to apply the Hide Surface style to the Corridor - (1) Pave and Corridor - (1) Top surfaces.

NOTE The Corridor - (1) Datum surface already uses the Hide Surface style.

- 6 On the command line, enter RENDER to render the corridor in 3D using the render materials that are applied to the subassembly links.

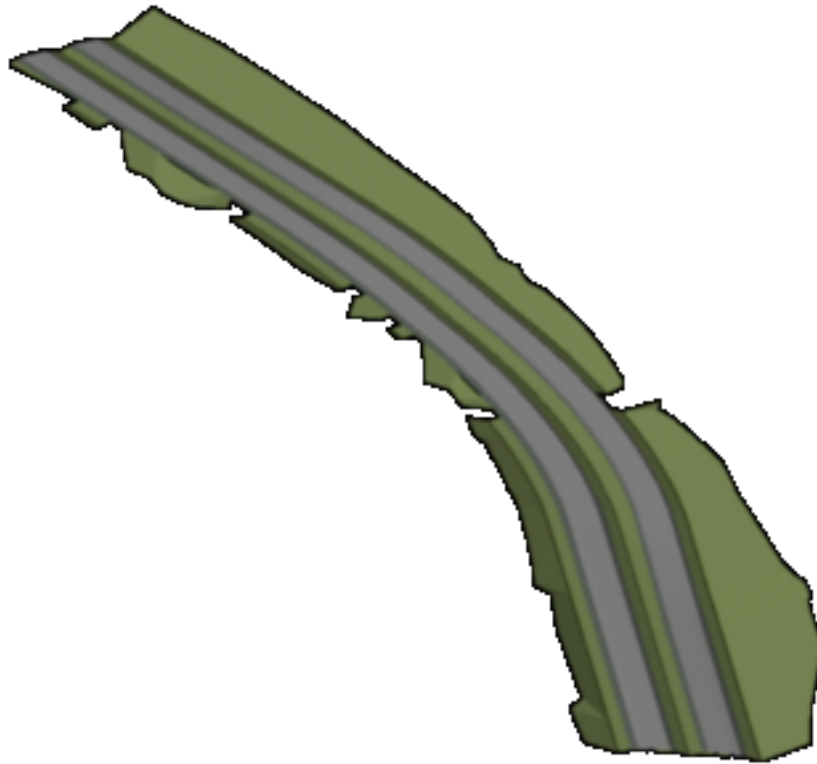

Next, you will view 2D hatch patterns on the corridor by applying shape styles to the appropriate subassembly links.

Apply 2D hatching to the corridor model

- 1 Click View tab ► Views panel ► Named Views list ► Corridor_All.
The drawing is redrawn to plan view.
- 2 In the drawing, select the corridor.
- 3 Click Corridor tab ► Modify Corridor panel drop-down ► Edit Code Set Styles.

- 4 On the Edit Code Sets dialog box, under Code Set Style, select All Codes With Hatching.

In the Material Area Fill Style column, notice that a fill has been applied to each of the subassembly links that you examined in the previous procedure. However, notice that Slope_Link does not have a Material Area Fill Style associated with it. In the next few steps, you will apply a style by modifying the code set style.

- 5 Click  Edit Current Selection.

NOTE You can also open the Code Set Style dialog box from Toolspace on the Settings tab. Expand General ► Multipurpose Styles ► Code Set Styles. Right-click the appropriate code set style and click Edit.

- 6 In the Code Set Style dialog box, on the Codes tab, under Link, in the Slope_Link row, set the Material Area Fill Style to Strip Hatch.

- 7 Click OK twice.

The material area fill styles are applied to the 2D corridor model. Zoom in on the beginning of the corridor to examine the hatch patterns.

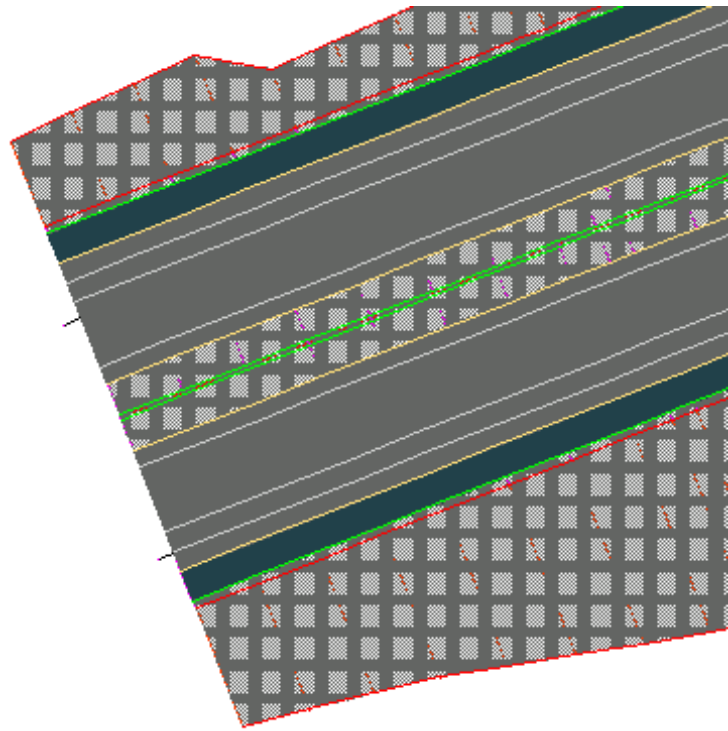

Intersection and Roundabout Tutorials

14

These tutorials will get you started working with intersections and roundabouts.

Intersections

An intersection object is created from two intersecting alignments that have design profiles. During the intersection creation process, alignments and profiles are automatically generated for the offset and curb return geometry. The horizontal and vertical geometry of the offsets and curb returns is dynamically linked to the intersection object. When changes are made to the centerline alignments or profiles, the offset and curb return geometry is automatically updated.

Roundabouts

A roundabout is created from two or more alignments that may or may not intersect. During the roundabout creation process, alignments are automatically generated for the offset and curb return geometry. The process also creates AutoCAD linework and blocks that represent traffic islands, pavement markings, and signs. The alignments and AutoCAD objects are dynamically linked to the parent alignments.

Differences Between Intersections and Roundabouts

The primary difference between an intersection and a roundabout is that an intersection is a AutoCAD Civil 3D object that is dynamic in both 2D and 3D. Profiles, corridors, and assemblies can be created automatically during the intersection creation process. A roundabout is a collection of 2D alignments that, while dynamic to one another in 2D, have no relationship in 3D. Profiles, corridors, and assemblies must be created independent from the roundabout, and they are not dynamically linked to each other or the roundabout.

NOTE All drawings used in these tutorials are available in the [tutorial drawings folder](#) (page 819). If you want to save your work from these tutorials, save the drawings to the [My Civil Tutorial Data folder](#) (page 819) so that you do not overwrite the original drawings.

For more information, see the AutoCAD Civil 3D Help topics *Understanding Intersections* and *Understanding Roundabouts*.

Tutorial: Creating Intersections

This tutorial demonstrates how to create several types of intersections.

You will create two basic types of intersections, which differ in how the intersecting road crowns are blended:

- In a *peer road* intersection, the crowns of both roads are maintained. The primary road centerline profile is maintained, and a locked PVI is created on the secondary road centerline profile where it intersects with the primary road centerline. The pavement of both roads is blended into the curb returns.
- In a *primary road* intersection, the primary road crown is maintained. The primary road centerline profile is maintained, and a locked PVI is created on the secondary road centerline profile where it intersects with the primary road centerline. Two additional locked PVIs are created on the secondary road centerline profile at the primary road edges of pavement. The primary road cross-slope is maintained, and the secondary road pavement is blended from the primary road edges of pavement along the secondary road pavement edges.

You will also experiment with curb return widening parameters, which are used to create turn lanes.

For information on adding widening regions to offset alignments that are outside the intersection area, see the [Adding a Widening to an Offset Alignment](#) (page 239) exercise.

For more information, see the AutoCAD Civil 3D Help topic *Creating Intersections*.

Exercise 1: Creating a Peer Road Intersection

In this exercise, you will create a three-way intersection and generate a corridor that maintains the crowns of both roads.

To create a complete intersection model, you must have a centerline alignment and profile for each of the intersecting roads. The horizontal and vertical



geometry for the remaining elements, including the offsets and curb returns, is generated based on the parameters you specify.

In a peer road intersection, the crowns of all intersecting roads are held at a common grade. The pavement for both roads is blended into the curb return regions, which form the transitions between the intersecting roads.

The drawing for this exercise contains a corridor along each of the intersecting roads. Each corridor is made up of a corridor assembly and a centerline alignment and profile.

For more information, see the AutoCAD Civil 3D Help topic *Creating Intersections*.

Specify the intersection location

- 1 Open *Intersection-Create-1.dwg*, which is located in the [tutorial drawings folder](#) (page 819).
- 2 Click Home tab ► Create Design panel ►  Intersections drop-down ►  Create Intersection.
- 3 In the drawing, click the intersection point of the two alignments.

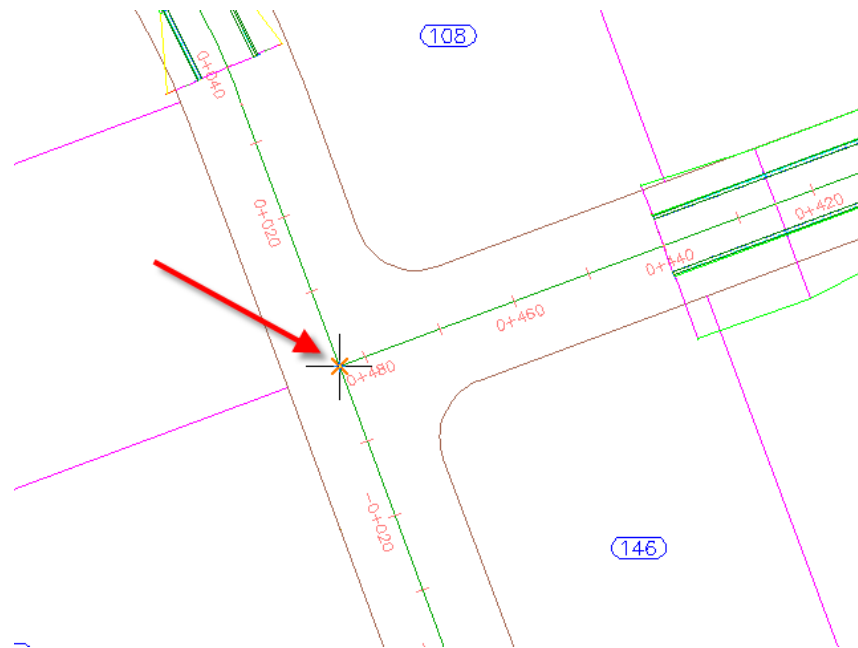

Specify the corridor grade parameters

- 1 In the Create Intersection wizard, on the General page, under Intersection Corridor Type, select All Crowns Maintained.
- 2 Click Next.

Specify the geometry of the offsets and curb returns

- 1 On the Geometry Details page, click Offset Parameters.
Default parameters are stored in the drawing settings. You can modify the default parameters during the intersection creation process.
- 2 In the Offset Parameters dialog box, specify the following parameters:
 - Secondary Road ► Left Offset Alignment Definition ► Offset Value: 3.5000
 - Secondary Road ► Right Offset Alignment Definition ► Offset Value: 3.5000
 - Create New Offsets From Start To End Of Centerlines: Cleared
When this option is selected, offset alignments are created along the entire length of the centerline alignment. This option is useful when you need to use offset alignments and profiles as targets for other objects, including other intersections along the same road.
- 3 Click OK.
- 4 On the Geometry Details page, click Curb Return Parameters.
- 5 In the Intersection Curb Return dialog box, under Curb Return Parameters, specify the following parameters:
 - Curb Return Type: Circular Fillet
 - Radius: 7.5

NOTE In the drawing, temporary graphics highlight the currently selected curb return.

- 6 Right-click Curb Return Parameters. Click Copy These To All Quadrants. This command copies the curb return parameters to all intersection curb return regions. The number of curb return regions is automatically generated based on the existing horizontal geometry. For example, if this was a four-way intersection, four curb return regions would be available.

- 7 Click OK.
- 8 In the Create Intersection wizard, under Offset And Curb Return Profiles, make sure that Create Offset And Curb Return Profiles is selected.
To produce a complete corridor model of the intersection, it is necessary to create profiles for the offset alignments and curb return alignments. For this exercise, you will accept the default offset and curb return profile settings.
- 9 Click Next.



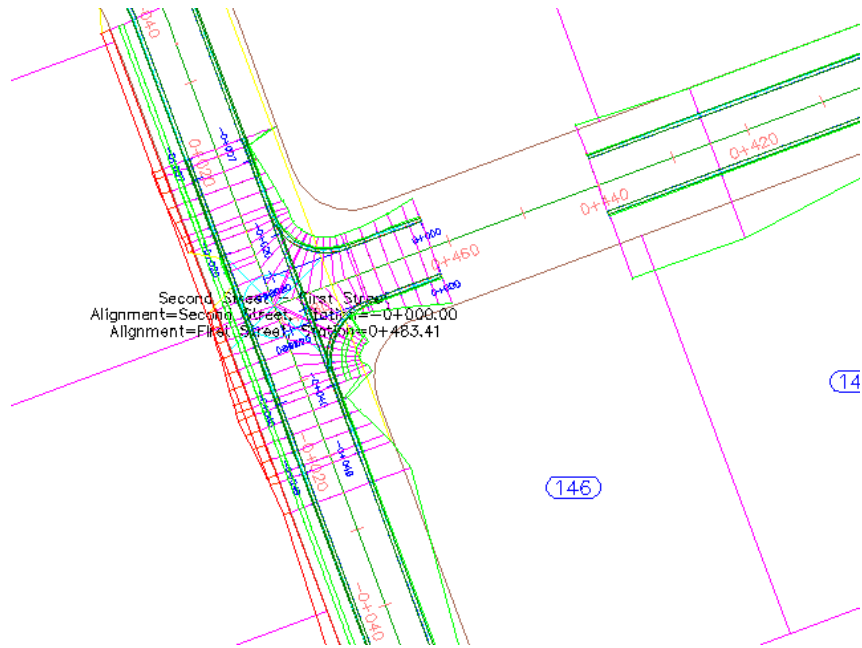

Specify the corridor parameters

- 1 On the Corridor Regions page, specify the following options:
 - Create Corridors In The Intersection Area: Selected
 - Add To An Existing Corridor: Selected, Second Street
 - Select Surface To Daylight: EG
- 2 Under Select Assembly Set To Import, click Browse.
- 3 In the Select Assembly Set File dialog box, navigate to the [tutorial folder](#) (page 820).
- 4 Select *Intersection-Assembly-Set_All Crowns.xml*. Click Open.
An assembly set enables you to quickly import a group of existing corridor assemblies, and then apply them to specific section types.
- 5 Click Create Intersection.
The intersection is created, and new corridor regions are created in the intersection area.





Examine the new objects

1 In Toolspace, on the Prospector tab, expand the  Alignments collection. Four alignments collections are available.

2 Under  Alignments, expand the  Centerline Alignments,  Offset Alignments, and  Curb Return Alignments collections.





At the beginning of this exercise, only Centerline Alignments existed. The Offset Alignments and Curb Return Alignments were created using the parameters that you specified in the Create Intersection wizard.

NOTE In the drawing, the offset alignments and station labels are blue, and the curb return alignments are red.

3 Under  Offset Alignments, expand the  First Street-Left-3.500  Profiles collection.

Layout profiles for the Offset Alignments and Curb Return Alignments were created using the parameters that you specified in the Create Intersection wizard.

Closing gaps in the corridor

- 1 In the drawing, select the corridor in the intersection area.
Slider  grips are displayed at the start and end stations of the corridor regions.
- 2 Click the  grip at station 0+040.
The grip turns red.
- 3 On the command line, enter 21.
- 4 Click Corridor tab ► Modify Region panel ►  Copy Region.
- 5 Select the portion of the Second Street corridor that loops around the site.
- 6 On the command line, enter F to fill a gap in the corridor.
- 7 Move the cursor toward the gap in the corridor.
A red graphic indicates that the gap may be filled.
- 8 Click when the red graphic is visible.
The gap is filled.
- 9 Press Enter to end the command.
- 10 Click Corridor tab ► Modify Corridor panel ►  Rebuild Corridor.
The Second Street corridor rebuilds, eliminating the gaps.

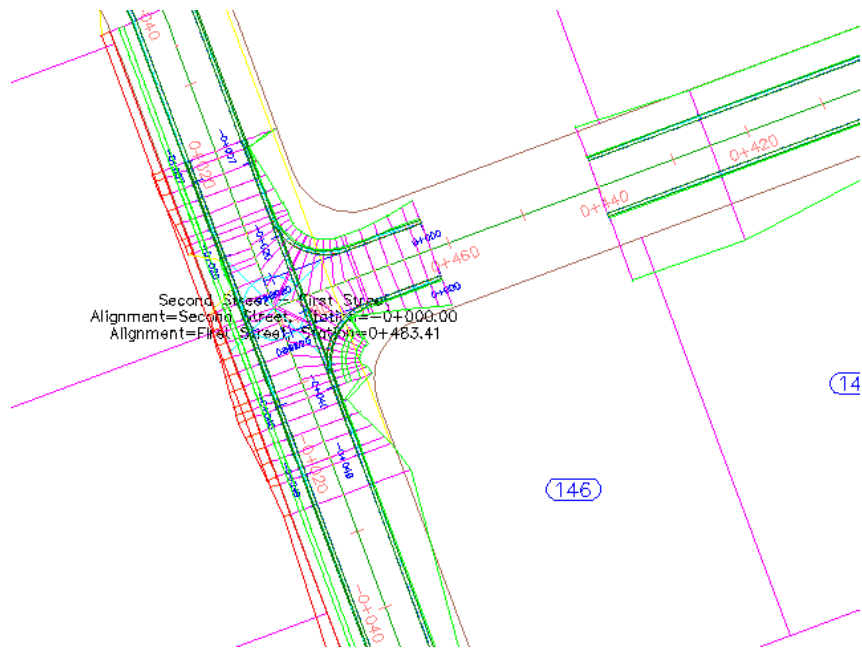

- 11 Select the First Street corridor. Select the  grip at Station 0+440. The grip turns red.
- 12 Drag the grip toward the intersection. Click to place the grip at the beginning of the intersection.
- 13 Right-click the First Street corridor. Click Rebuild Corridor. The corridor rebuilds, eliminating the gaps between it and the intersection.

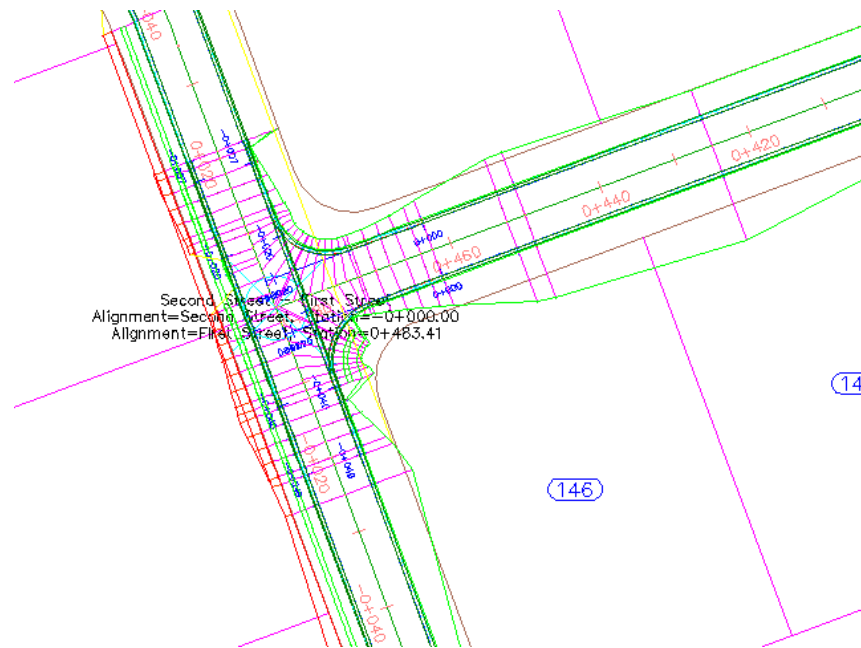

To continue this tutorial, go to [Exercise 2: Creating a Primary Road Intersection with Turn Lanes](#) (page 503).

Exercise 2: Creating a Primary Road Intersection with Turn Lanes



In this exercise, you will create an intersection with entry and exit turn lanes at the primary road. The secondary road crown will blend into the primary road edge of pavement.

You can use the workflow that is demonstrated in this exercise to create an intersection with any combination of turn lanes at the curb returns.

For more information, see the AutoCAD Civil 3D Help topic *Creating Intersections*.

Specify the intersection location and primary road

- 1 Open *Intersection-Create-2.dwg*, which is located in the [tutorial drawings folder](#) (page 819).

- 2 Click Home tab ► Create Design panel ►  Intersections drop-down ►  Create Intersection.
- 3 In the drawing, click the intersection point of the Road A and Road B alignments.

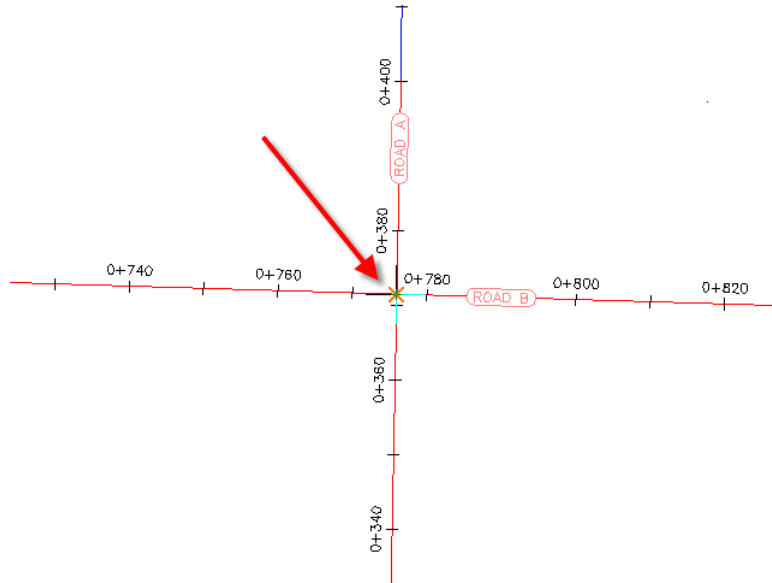

- 4 Click the Road A alignment to specify it as the primary road.

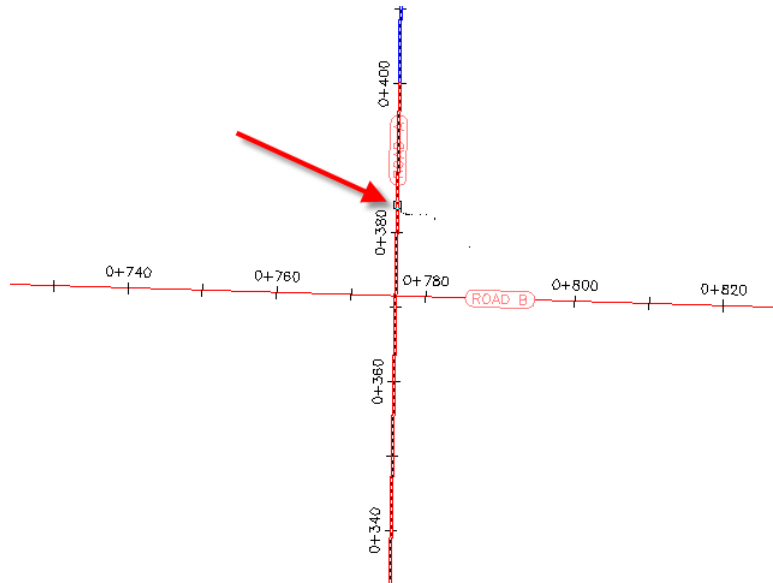

Specify the corridor grade parameters

- 1 In the Create Intersection wizard, on the General page, under Intersection Corridor Type, select Primary Road Crown Maintained.
- 2 Click Next.

Specify the horizontal and vertical geometry parameters

- 1 On the Geometry Details page, click Offset Parameters.
Default horizontal and vertical geometry parameters are stored in the drawing settings. You can modify the default parameters during the intersection creation process.
- 2 In the Offset Parameters dialog box, specify the following parameters:
 - Primary Road ► Left Offset Alignment Definition ► Offset Value: 6.0000
 - Primary Road ► Right Offset Alignment Definition ► Offset Value: 6.0000
 - Secondary Road ► Left Offset Alignment Definition ► Offset Value: 3.0000

- Secondary Road ► Right Offset Alignment Definition ► Offset Value: 3.0000
 - Create New Offsets From Start To End Of Centerlines: Selected
- 3 Click OK.
 - 4 On the Geometry Details page, click Curb Return Parameters.

The default parameters for the first intersection quadrant are displayed in the Intersection Curb Return Parameters dialog box. In the drawing, the first quadrant is highlighted, and arrows indicate the direction of incoming and outgoing traffic.

NOTE If you cannot see the temporary graphics, move the dialog box.

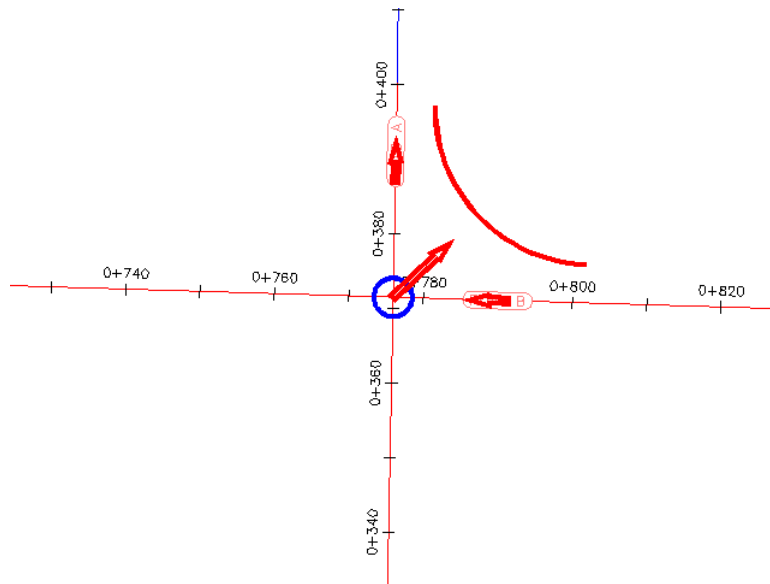

- 5 In the Intersection Curb Return dialog box, select the Widen Turn Lane For Outgoing Road check box.

The Widening Details At Outgoing Lane parameter collection is displayed in the property tree. When you highlight a property, the preview graphic at the bottom of the dialog box updates to illustrate the property in a typical intersection. Examine the default values that have been specified for this drawing, but do not change any of them.
- 6 Click Next.

- 7 For SE - Quadrant, select the Widen Turn Lane For Incoming Road check box.
- 8 Click Next.
- 9 For SW - Quadrant, select the Widen Turn Lane For Outgoing Road check box.
- 10 Click Next.
- 11 For NW - Quadrant, select the Widen Turn Lane For Incoming Road check box.
- 12 Click OK.
- 13 In the Create Intersection wizard, make sure that the Create Offset And Curb Return Profiles check box is selected.
- 14 Click Next.

Specify the corridor parameters

- 1 On the Corridor Regions page, specify the following options:
 - Create Corridors In The Intersection Area: Selected
 - Create A New Corridor: Selected
 - Select Surface To Daylight: Existing Ground
- 2 In the Select Assembly Set File dialog box, navigate to the [Assemblies folder](#) (page 819).
- 3 Select *_Autodesk (Metric) Assembly Sets.xml*. Click Open.
- 4 Under Maintain Priority Road Crown, in the Curb Return Fillets row, click .

You can use the Select An Assembly dialog box to substitute an assembly with another assembly that is in the current drawing. To save your changes as a new assembly set, click Save As Set on the Corridor Regions page. For this exercise, you will accept the default assembly set.

For more information about managing corridor assemblies, see the [Corridor Assembly Tutorials](#) (page 421).
- 5 Click Cancel.
- 6 Click Create Intersection.

The intersection is created, and new corridor regions are created in the intersection area. Notice that the curb returns have widening regions to allow traffic to exit from and merge onto Road A.

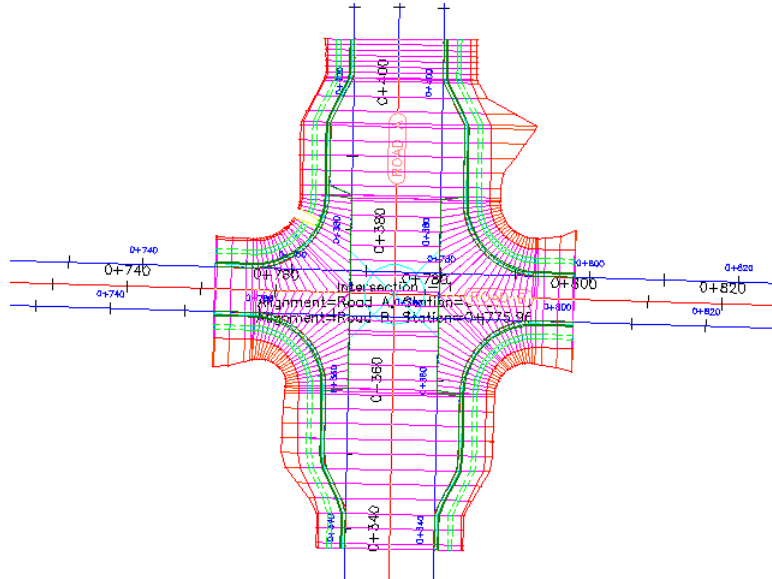

To continue this tutorial, go to [Exercise 3: Creating an Intersection with Existing Geometry](#) (page 508).

Exercise 3: Creating an Intersection with Existing Geometry

In this exercise, you will use the existing offset alignments and profiles of the primary road to create an intersection, and then add the new intersection to the existing primary road corridor.



The workflow that is demonstrated in this exercise is useful when you need to create several intersections along a single corridor. You define the offset geometry for the primary road, and then reuse it for subsequent intersections.

For more information, see the AutoCAD Civil 3D Help topic *Creating Intersections*.

Specify the intersection location and primary road

- 1 Open *Intersection-Create-3.dwg*, which is located in the [tutorial drawings folder](#) (page 819).

This drawing contains an intersection of two alignments, Road A and Road C. Offset alignments exist on either side of Road A, and there is an existing intersection north of Road C.

- 2 Click Home tab ► Create Design panel ►  Intersections drop-down ►  Create Intersection.
- 3 In the drawing, click the intersection point of the Road A and Road C alignments.

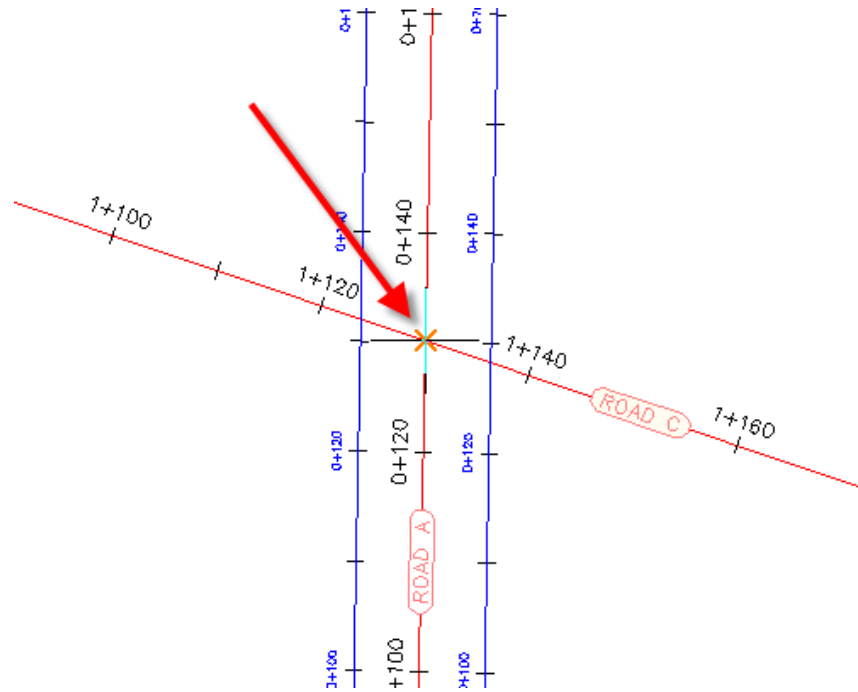

- 4 Click the Road A alignment to specify it as the primary road.

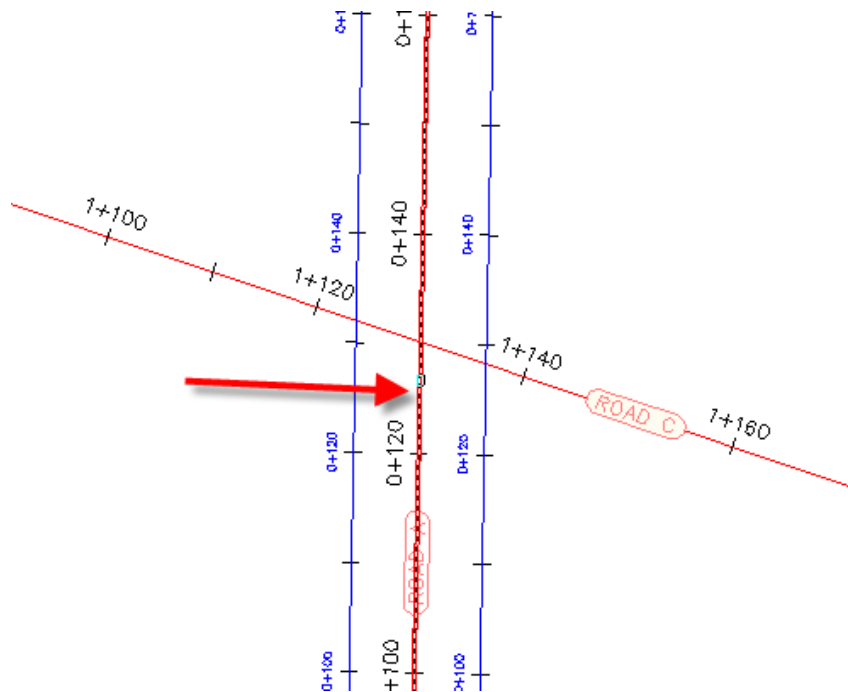

Specify the corridor grade parameters

- 1 In the Create Intersection wizard, on the General page, under Intersection Corridor Type, select Primary Road Crown Maintained.
- 2 Click Next.

Specify the horizontal geometry parameters

- 1 On the Geometry Details page, click Offset Parameters.
- 2 In the Offset Parameters dialog box, under Primary Road ► Left Offset Alignment Definition, for Use An Existing Alignment, select Yes.
- 3 For Alignment Name, click .
- 4 In the Intersection Offset Alignment Name dialog box, click .
- 5 In the drawing, select the offset alignment on the left-hand side of the Road A alignment.

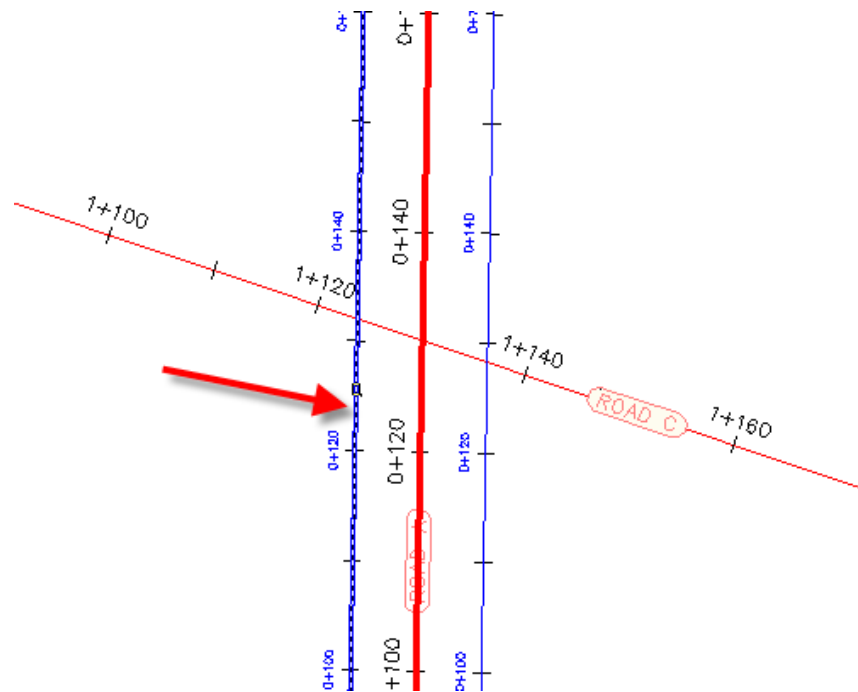

- 6 Click OK.
- 7 In the Intersection Offset Parameters dialog box, for Right Offset Alignment Definition, repeat Steps 2 through 6 to assign the offset alignment that is on the right-hand side of the Road A alignment.

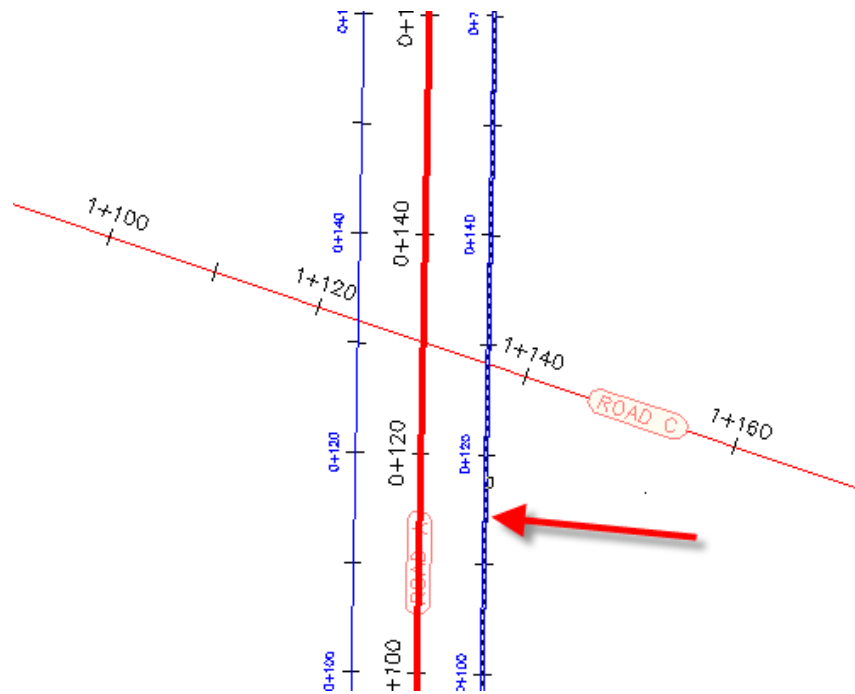

- 8 Click OK.
- 9 On the Geometry Details page, click Curb Return Parameters.
The default parameters for the first intersection quadrant are displayed in the Intersection Curb Return Parameters dialog box. In the drawing, the first quadrant is highlighted, and arrows indicate the direction of incoming and outgoing traffic.

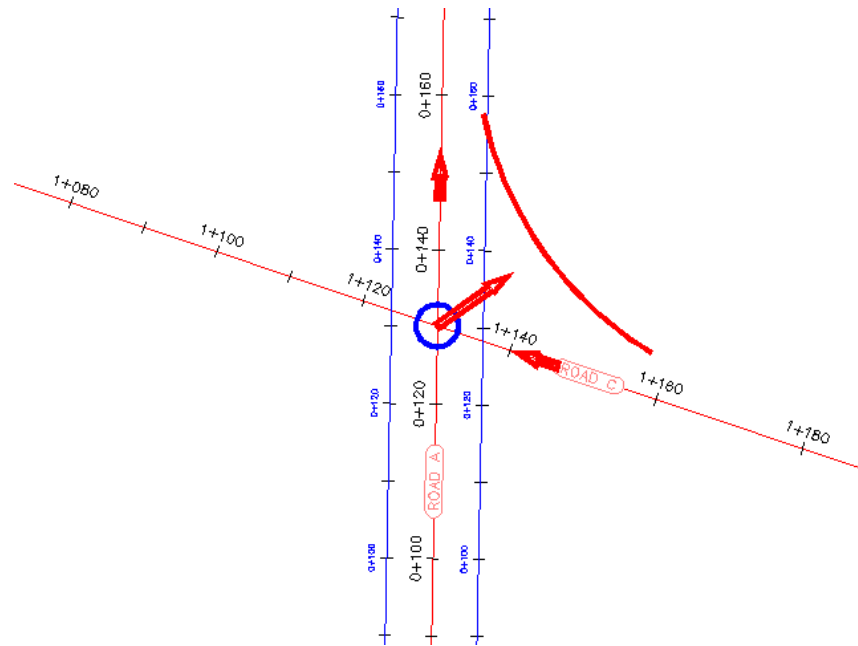

- 10 In the Intersection Curb Return dialog box, under Intersection Quadrant, select SE - Quadrant.
- 11 SE - Quadrant, select the Widen Turn Lane For Incoming Road check box.
- 12 Under Intersection Quadrant, select NW - Quadrant.
- 13 NW - Quadrant, select the Widen Turn Lane For Incoming Road check box.
- 14 Click OK.
- 15 In the Create Intersection wizard, make sure that the Create Offset And Curb Return Profiles check box is selected.
- 16 Click Next.

Specify the vertical geometry parameters

- 1 On the Geometry Details page, under Offset and Curb Return Profiles, click Lane Slope Parameters.

- 2 In the Intersection Lane Slope Parameters dialog box, under Primary Road ► Left Offset Alignment Definition, for Use An Existing Alignment, select Yes.
- 3 For Profile Name, click .
- 4 In the Intersection Offset Alignment Name dialog box, select Road A - -2.000%.
- 5 Click OK.
- 6 In the Intersection Offset Parameters dialog box, for Right Edge Profile Definition, repeat Steps 2 through 5 to assign the offset profile that is on the right-hand side of the Road A alignment. Use profile Road A - -2.000% (1) as the Right Edge Profile Definition ► Profile Name.
- 7 Click OK.

Specify the corridor parameters

- 1 On the Corridor Regions page, specify the following options:
 - Create Corridors In The Intersection Area: Selected
 - Add To An Existing Corridor: Selected, Corridor - (1)
 - Select Surface To Daylight: Existing Ground
- 2 Under Select Assembly Set To Import, click Browse.
- 3 In the Select Assembly Set File dialog box, navigate to the [Assemblies folder](#) (page 819).
- 4 Select *_Autodesk (Metric) Assembly Sets.xml*. Click Open.
- 5 Click Create Intersection.

The intersection is created, and new corridor regions are created in the intersection area.

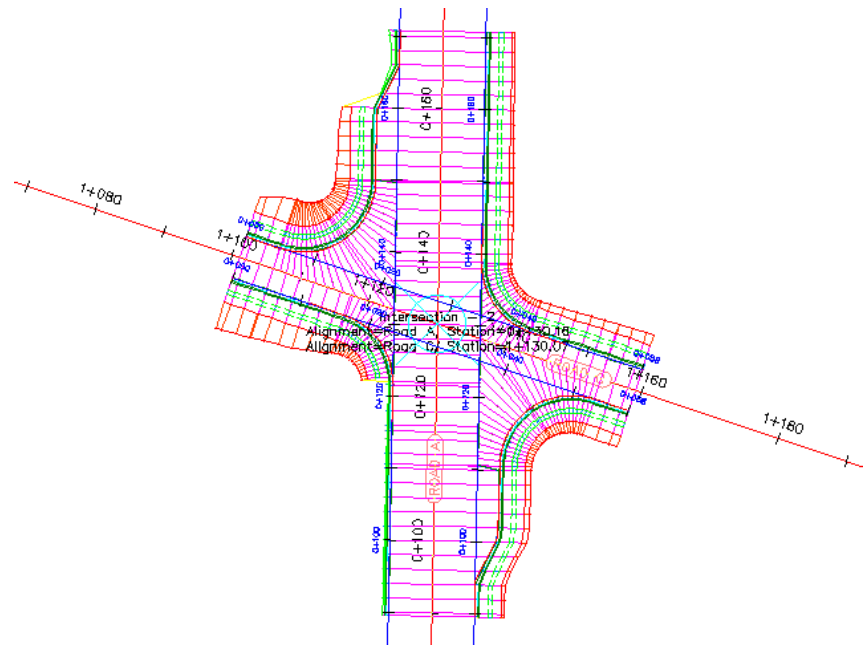

Further exploration: To extend the corridor between the two intersections, add a corridor region between the two intersections.

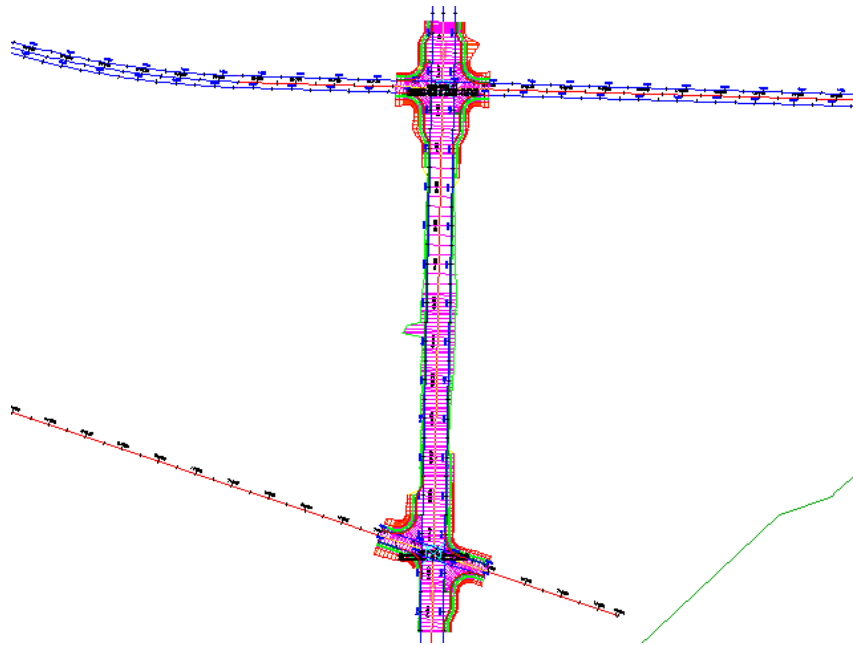

To continue to the next tutorial, go to [Editing Intersections](#) (page 516).

Tutorial: Editing Intersections

This tutorial demonstrates how to modify an existing intersection object.

When an intersection is created between two roads, one of the roads is designated as the primary road. The elevation of the other road, which is known as the secondary road, is locked to the primary road. As changes are made to the horizontal or vertical intersection geometry, the secondary road design profile is adjusted to accommodate the horizontal and vertical position of the primary road.

For more information, see the AutoCAD Civil 3D Help topic *Editing Intersections*.

Exercise 1: Editing the Horizontal Geometry of an Intersection

In this exercise, you will edit the alignments that define the horizontal geometry of an intersection. You will edit the alignments graphically and parametrically, and then examine how the changes affect the intersection.

For more information, see the AutoCAD Civil 3D Help topic *Editing Offset Alignments and Widening*.

Modify offset alignment parameters

- 1 Open *Intersection-Edit-Horizontal.dwg*, which is located in the [tutorial drawings folder](#) (page 819).

This drawing contains an intersection of a primary road (Road A) and a secondary road (Road B).

- The offset alignments for Road A extend along the full length of the centerline alignment.
- The offset alignment for Road B does not extend beyond the intersection extents.
- The curb returns have widening regions on all four corners of Road A.

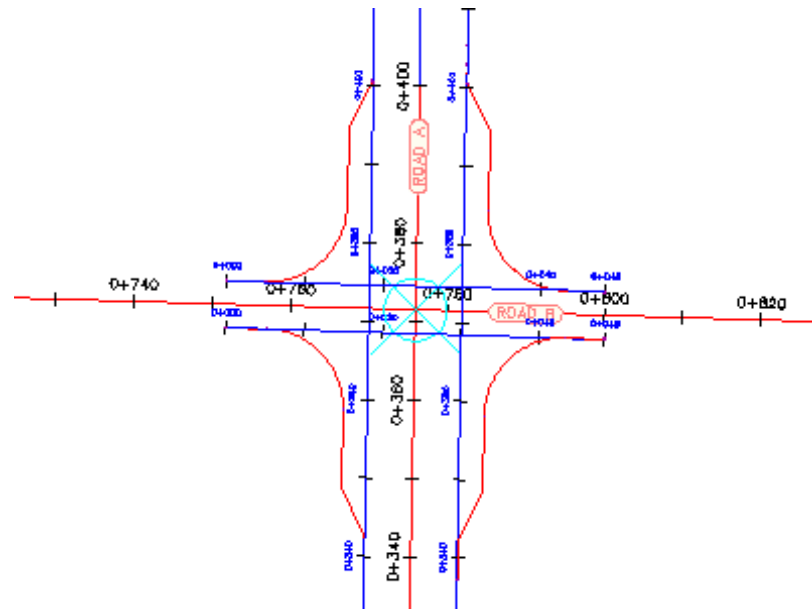

- 2 Click the intersection marker.

The Intersection tab is displayed on the ribbon. The Modify panel has tools that you can use to modify the parameters of the horizontal and vertical geometry of the intersection.

- 3 Click Intersection tab ► Modify panel ► Edit Offsets  .
The offset alignment parameters are displayed in the Intersection Offset Parameters dialog box.
- 4 Under Secondary Road, change the Offset Value for both offset alignments to 4.000.
Notice that as the values change, the intersection updates in the drawing.

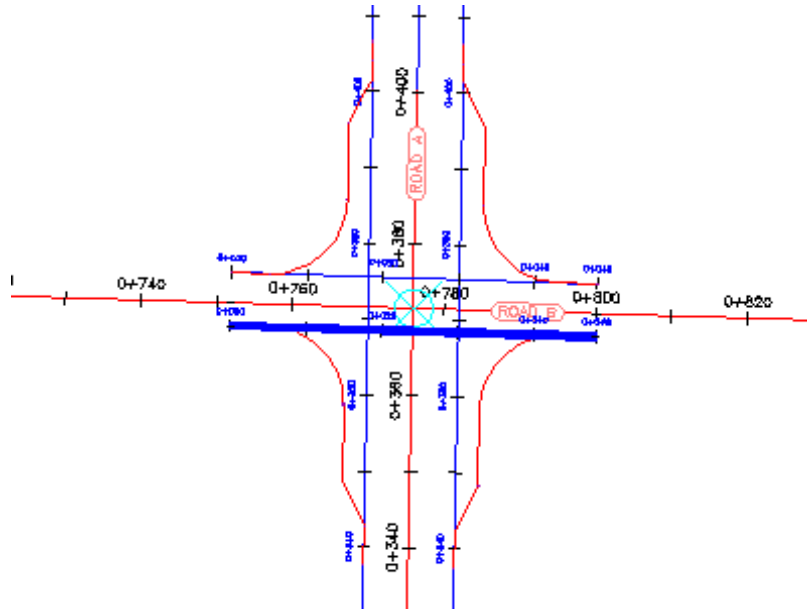

Modify the curb return parameters

- 1 Click Intersection tab ► Modify panel ► Edit Curb Returns  .
The Intersection Curb Return Parameters dialog box displays the curb return alignment parameters for the northeast intersection quadrant. This dialog box enables you to change basic parameters, as well as specific details of the curb return at each intersection quadrant.
In the drawing, notice that the currently selected curb return is highlighted.

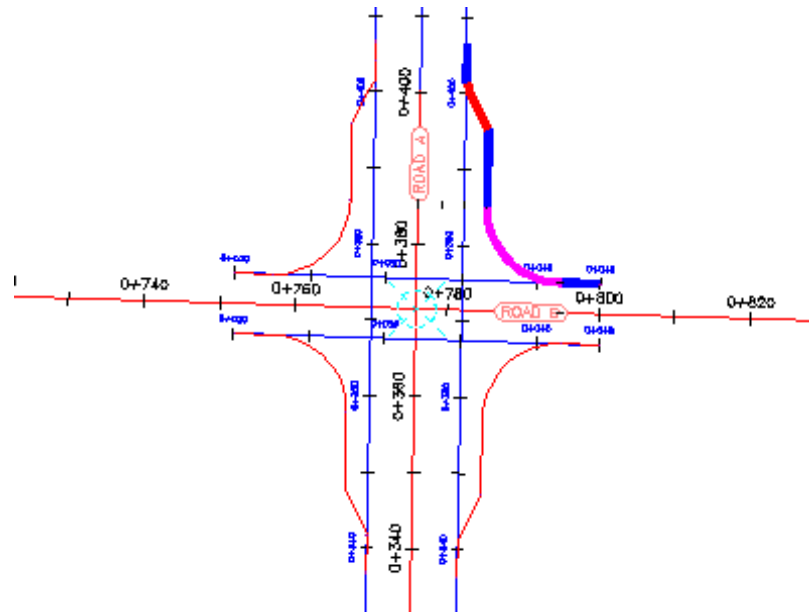

- 2 Clear the Widen Turn Lane For Outgoing Road check box.
In the drawing, the widening region for the northeast quadrant is removed.

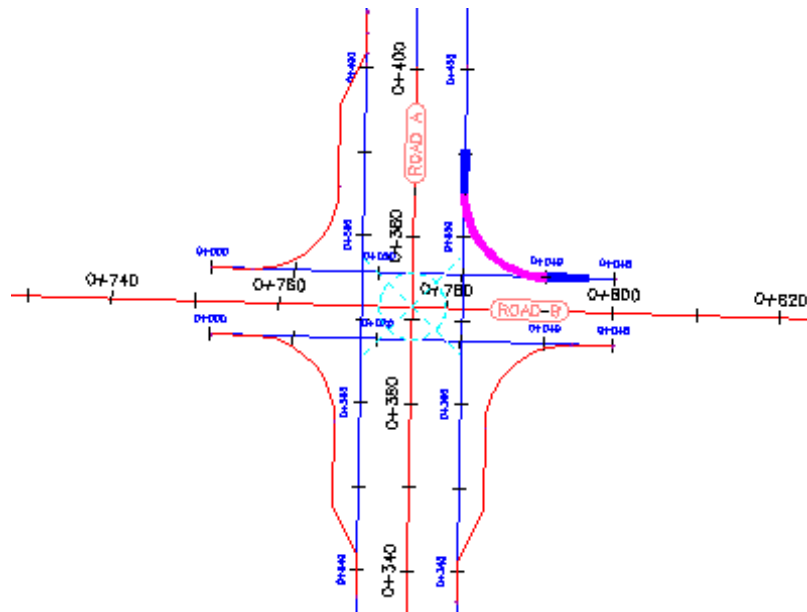

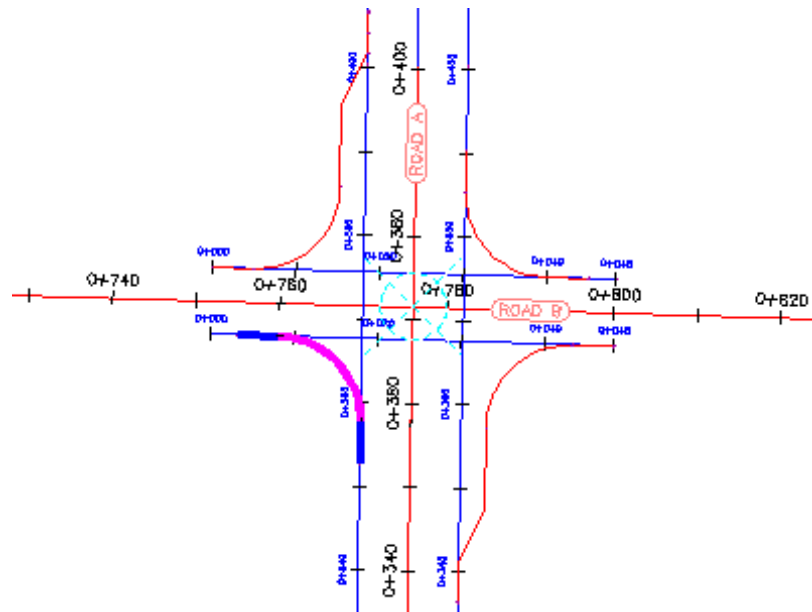

- 3 Under Intersection Quadrant, click SW - Quadrant.
- 4 Clear the Widen Turn Lane For Outgoing Road check box.

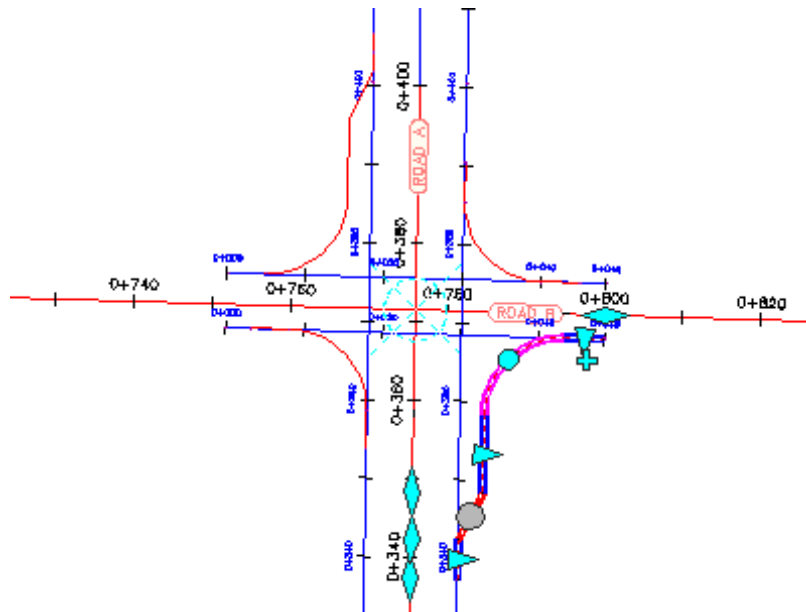

Grip edit a curb return alignment

- 1 In the drawing, select the southeast curb return alignment.
Grips appear along the curb return alignment.



- 2 On the Road A alignment, experiment with the  grips. When you move a grip, the curb return widening region updates, and the values update in the Intersection Curb Return Parameters dialog box. For more information about the widening grips, see the AutoCAD Civil 3D Help topic *Editing Offset Alignments and Widening*s.

- 3 Press Esc.

Grip edit the centerline alignments

- 1 Select both offset alignments along Road B.
- 2 Click the  grip on the left. Drag the grip to the left. Click near station 0+660 to place the grip.

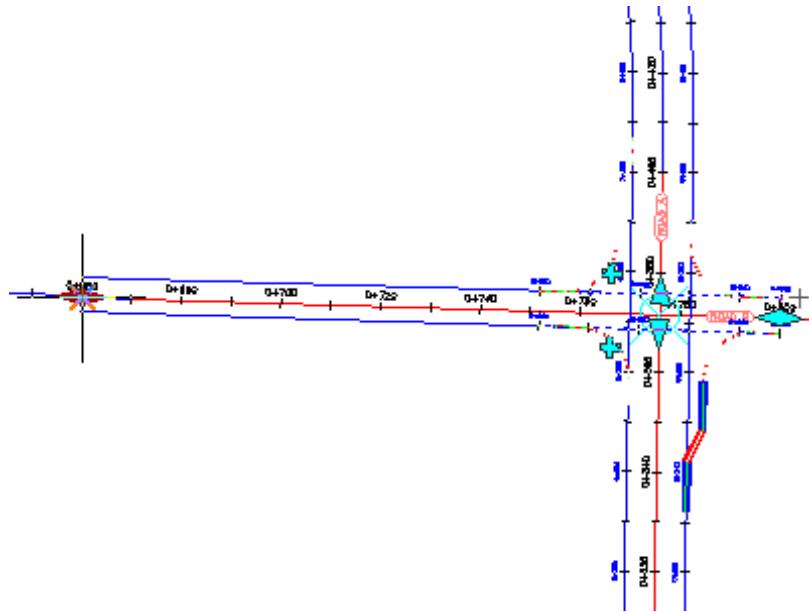

This action enables the relationship between the curb returns and the offset alignments to be maintained as you move the intersection along the centerline alignment.

- 3 Press Esc.
- 4 Zoom out to see the ends of both centerline alignments.
- 5 Select the Road A centerline alignment.
- 6 Select the grip at the southern end of the alignment.
- 7 Drag the grip to the left. Click to place the grip.

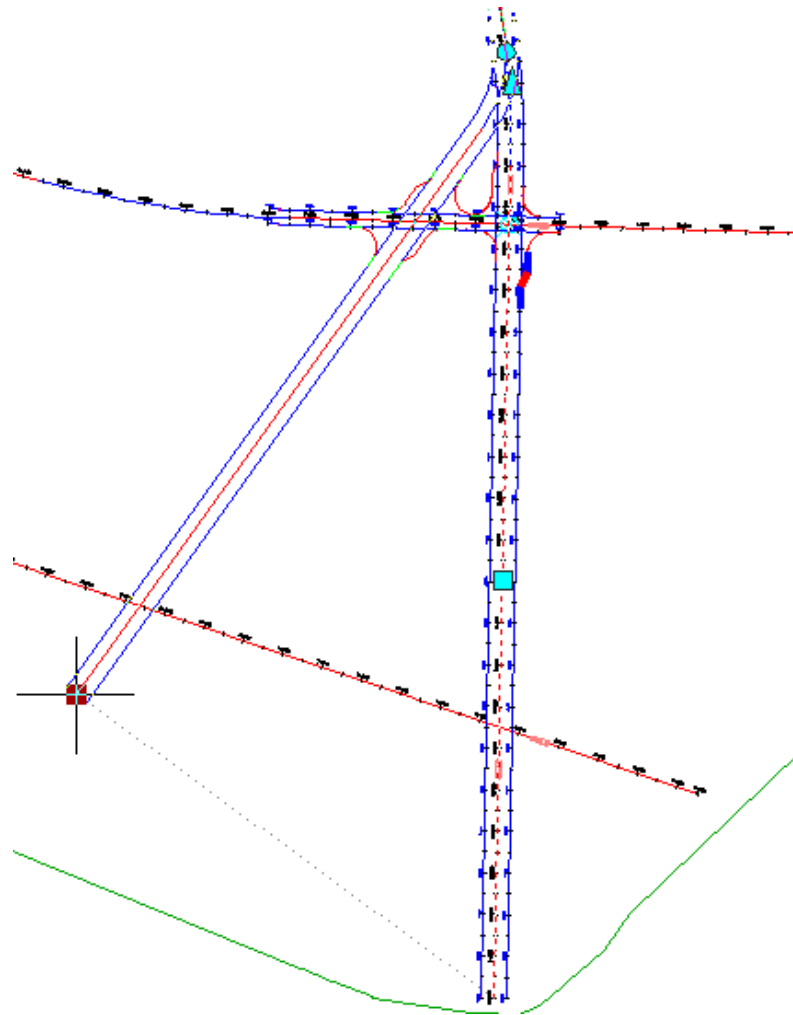

The intersection slides along the Road B centerline and offset alignment. The curb return alignments and Road A offset alignments move to accommodate the new intersection point. The curb return and offset alignment geometry parameters are maintained.

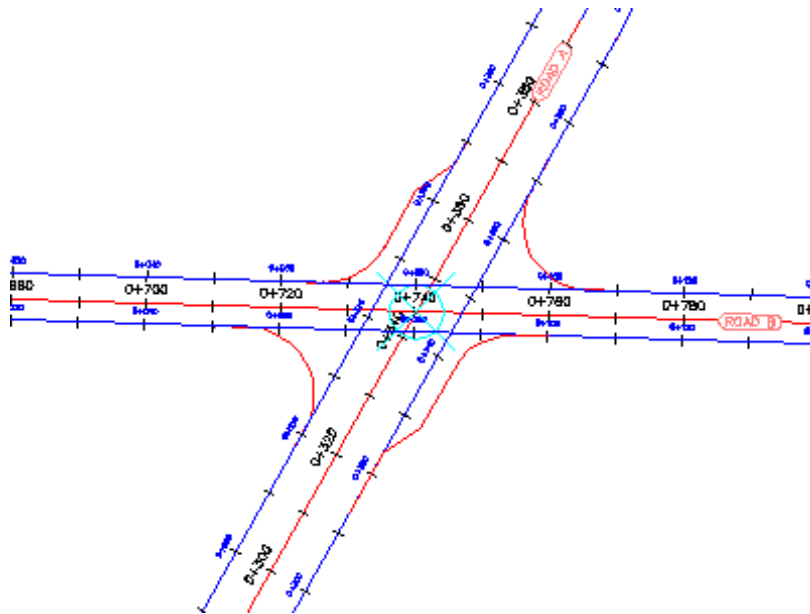

To continue this tutorial, go to [Exercise 2: Editing the Vertical Geometry of an Intersection](#) (page 525).

Exercise 2: Editing the Vertical Geometry of an Intersection

In this exercise, you will edit the profiles that define the vertical geometry of an intersection object. You will edit the profiles graphically and parametrically, and examine how the changes affect the intersection.

For more information, see the AutoCAD Civil 3D Help topic *Editing Intersections*.

Examine locked PVI's

- 1 Open *Intersection-Edit-Vertical.dwg*, which is located in the [tutorial drawings folder](#) (page 819).

This drawing contains an intersection of a primary road (Road A) and a secondary road (Road C).

- 2 In the lower right viewport, select the layout profile.

Notice that  lock icons are displayed on three of the PVI. The lock icons indicate that the PVI are locked to another profile. When the intersection was created, the middle PVI was created at the point where the secondary road intersects with the primary road profile. The other two PVI were created to maintain the primary road crown through the intersection, and are locked to the edges of the primary road.

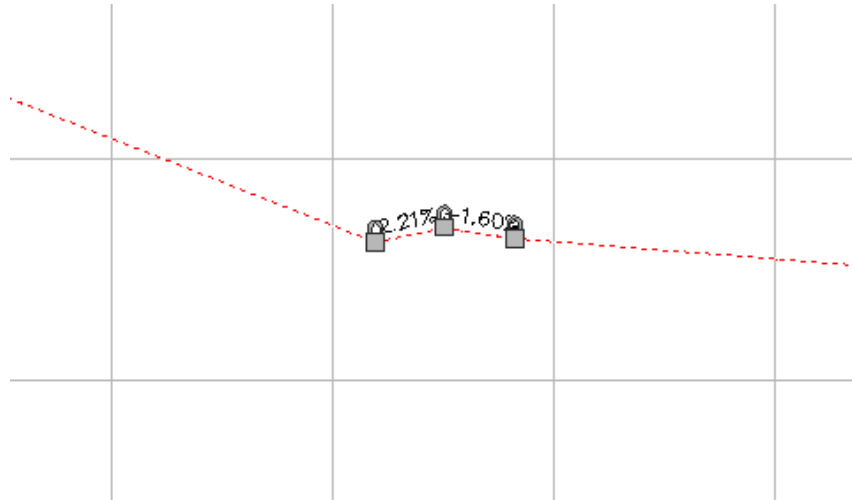

3 Click Profile tab ► Modify Profile panel ►  Geometry Editor.

4 On the Profile Layout Tools toolbar, click .

In the Profile Entities vista, notice that a  is displayed in the Lock column for PVI 5 through 7.

5 Hover the cursor over the  icon for PVI 6.

Information about the locked PVI, including alignment, profile, and intersection, is displayed in a tooltip. PVI that are created as part of the intersection creation process are dynamically linked to the primary road profile.

NOTE You can unlock a PVI by clicking the icon. If a PVI is unlocked, the profile will no longer react to changes in either the intersection or primary road profile.

- 6 Click the  icon for PVI 8.

The PVI is locked at the current station and elevation. Notice that another  icon is displayed on the profile, and the PVI Station and PVI Elevation values are no longer available. A PVI can be manually locked to a specified station and elevation value. Manually locked PVIs are not affected by modifications to other portions of the profile.

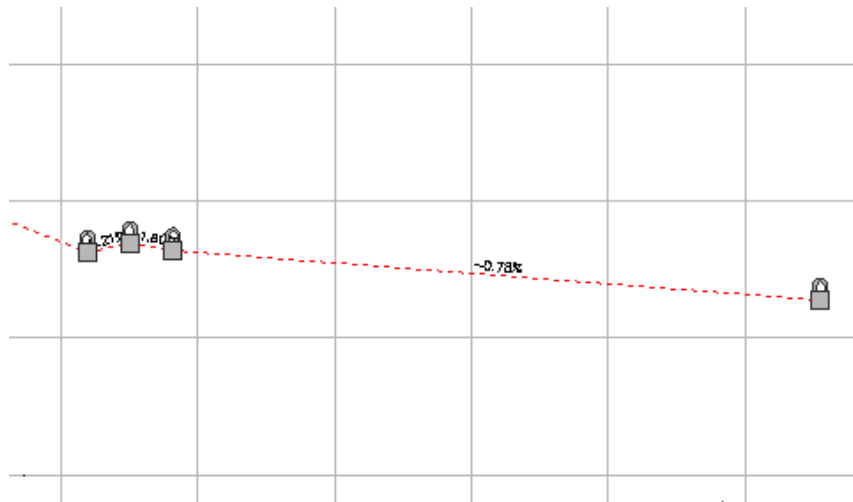

- 7 Close the Profile Layout Tools toolbar.
- 8 In the left viewport, select the intersection marker.
On the ribbon, the Intersection tab is displayed. Tools for adjusting the side road profile are displayed on the Modify panel. You can edit the primary road profile with the standard profile editing tools.

Modify the secondary road grade

- 1 Click Intersection tab ► Modify panel ►  Side Road Profile.
The Secondary Road Profile Rules dialog box is displayed. Use this dialog box to specify the secondary road grade entering and exiting the intersection.
- 2 In the Secondary Road Profile Rules dialog box, specify the following parameters:

NOTE Enter the parameters in the following order.

- Apply Grade Rules: Yes
- Distance Rule To Adjust The Grade: Specify Distance
This option enables you to specify a distance from the intersection of the primary and secondary road alignments. This enables you to extend the side road grade rules outside the extents of the intersection.
- Distance Value: 100.000m
- Maximum Grade Change: 2.00%

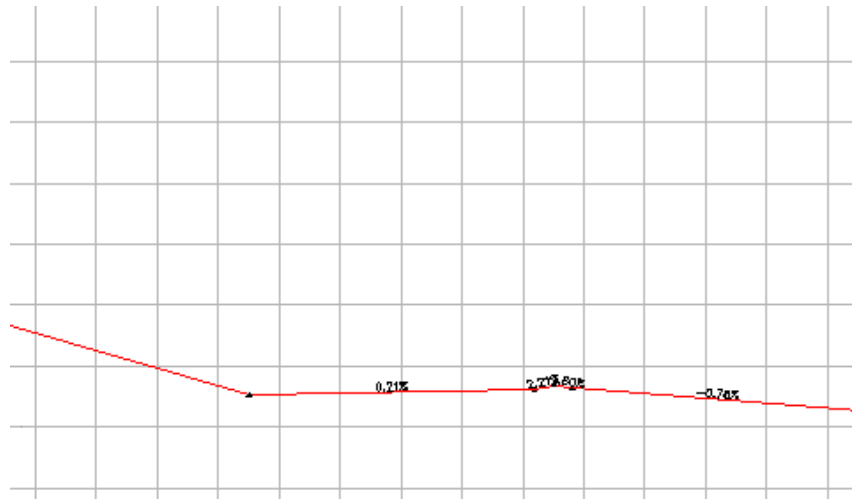

In the lower right viewport, a new PVI is created 100 meters to the left of the locked PVIs. The grade entering the intersection is 0.21%, which is exactly 2.00% less than the primary road grade.







- 3 In the lower right viewport, select the layout profile.
You can move the grip at the PVI to make minor changes to the profile. If you drag the grip outside the range of parameters specified in the profile grade rules, the grip snaps back to the default position that satisfies the grade rules.
- 4 Close the Secondary Road Profile Rules dialog box.
- 5 Press Esc.

Add a low point to a curb return profile

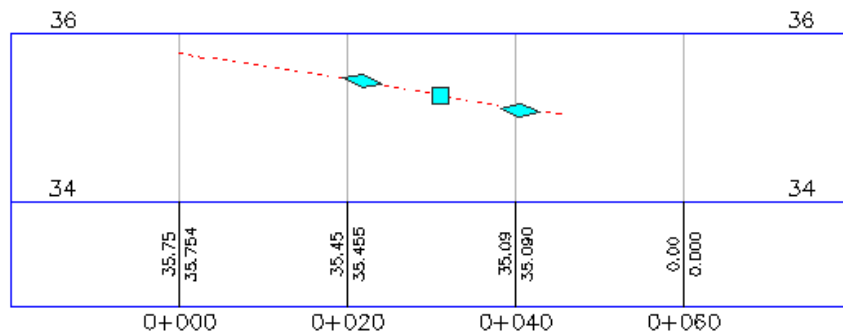
- 1 In the upper right viewport, zoom in to the Intersection - 2 - (SE) profile view.
- 2 Select the profile.

The  grips indicate the extents of the curb return profile. The profile portions that are outside the extents represent the offset profiles. Changes to the offset profiles affect the curb return profiles, but changes to the curb return profile do not affect the offset profiles. Use the  grips to extend the curb return profile along either offset profile.



- 3 Click Profile tab ► Modify Profile panel ► Geometry Editor .
- 4 On the Profile Layout Tools toolbar, click  Insert PVI.
- 5 Click between the two  grips to place a PVI, creating a low point on the curb return.

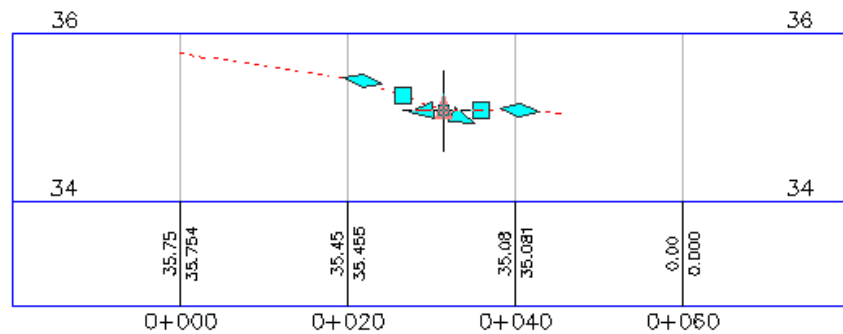

A low point facilitates drainage along a curb return. In the following procedures, you will see how the curb return reacts to changes in other objects.

- 6 Close the Profile Layout Tools toolbar.

Move the primary road alignment

- 1 In the left viewport, select the Road A alignment.
- 2 Select the grip at the southern end of the Road A alignment. Drag the grip to the left. Click to place the grip.

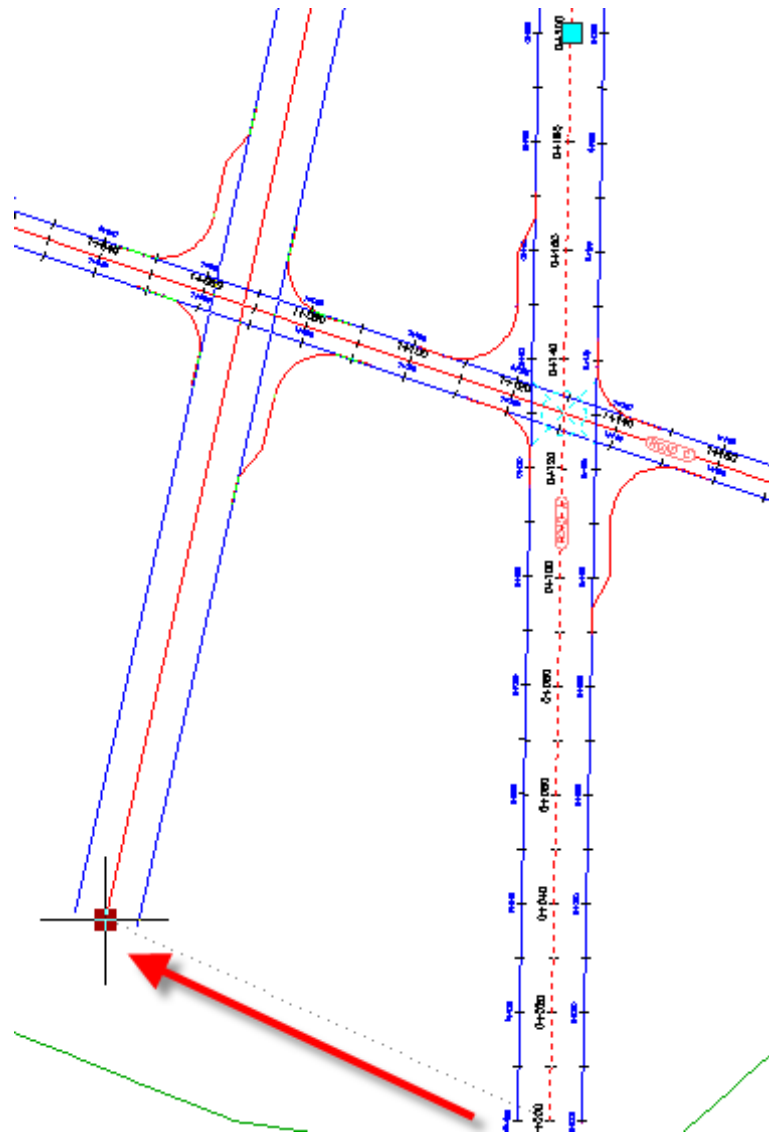

In the bottom right viewport, notice that the three dynamically locked PVI's moved to a new location. This happened because you moved the alignment to which they are locked.

In the top right viewport, examine how the changes to the intersection location affect the curb return profile that you modified.

Change the primary road profile elevation

- 1 In the top viewport, pan to the Road A profile view.
- 2 In the Road A Profile view, select the layout profile.
- 3 Select the second  PI grip from the left. Drag the grip up. Click to place the grip.

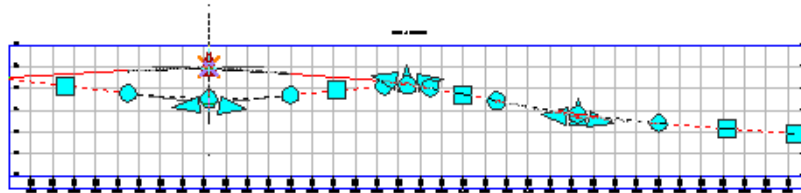

In the bottom viewport, notice that the three locked PVIs moved up to accommodate the new primary road elevation.

In the top right viewport, the PVI you added to the southeast curb return has stayed in the location you specified, but the ends of the profile moved up to accommodate the new elevation of the offset profiles. The ends of the curb return profile are locked to the offset profiles. You must manually update PVIs that have been placed within the profile.

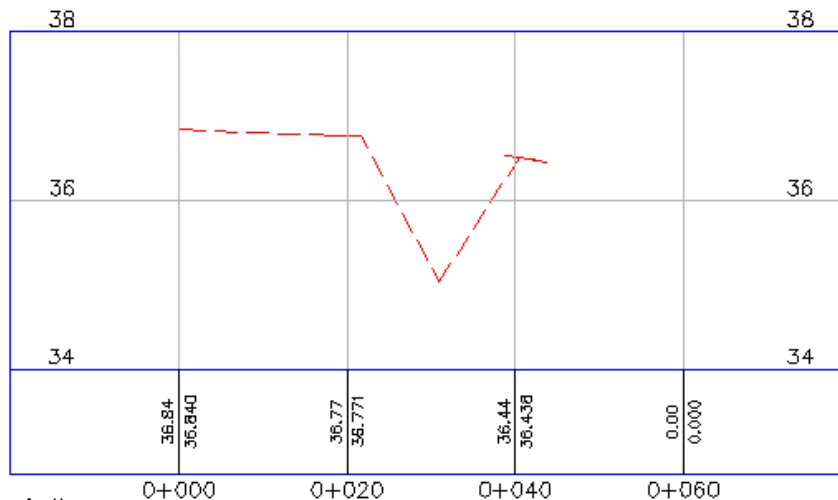

To continue this tutorial, go to [Exercise 3: Creating and Editing a Corridor in the Intersection Area](#) (page 533).

Exercise 3: Creating and Editing a Corridor in the Intersection Area

In this exercise, you will create a corridor using existing vertical and horizontal geometry. You will modify the corridor in the intersection area, and then experiment with the corridor region recreation tools.

For more information, see the AutoCAD Civil 3D Help topics *Updating Corridor Regions in Intersections* and *Recreating Corridor Regions in Intersections*.

Create a corridor in the intersection area

- 1 Open *Intersection-Edit-Corridor.dwg*, which is located in the [tutorial drawings folder](#) (page 819).

This drawing contains an intersection of a primary road (Road A) and a secondary road (Road B). There currently are no corridors or corridor assemblies in the drawing.

- 2 Select the intersection marker.

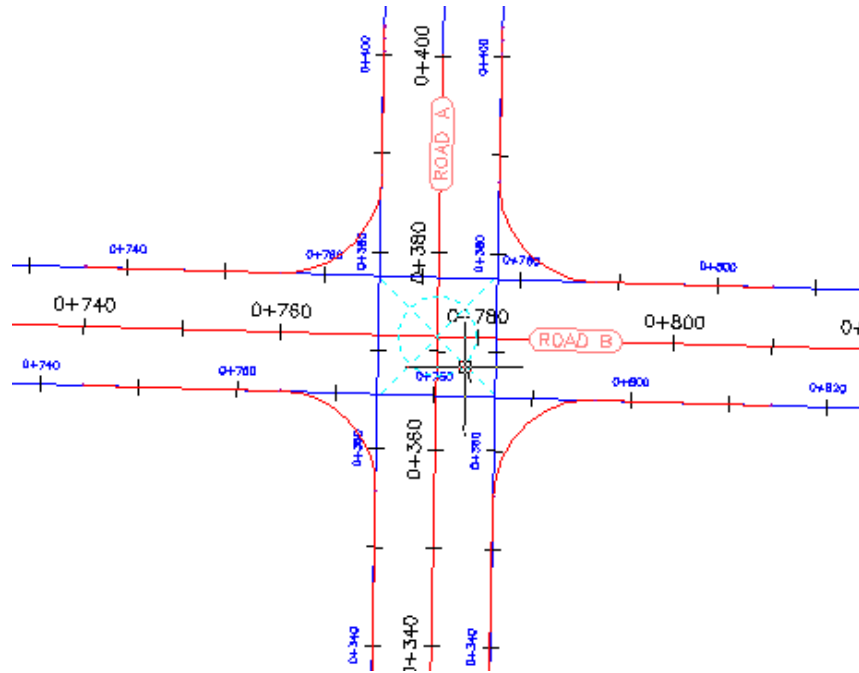

- 3 Click Intersection tab ► Modify panel ►  Recreate Corridor Regions.



The Intersection Corridor Regions dialog box is displayed.

- 4 Under Select Surface To Daylight, select Existing Ground.
- 5 Under Apply An Assembly Set, click Browse.
- 6 In the Select Assembly Set File dialog box, navigate to the [Assemblies folder](#) (page 819).
- 7 Select *_Autodesk (Metric) Assembly Sets.xml*. Click Open.
- 8 Click Recreate.

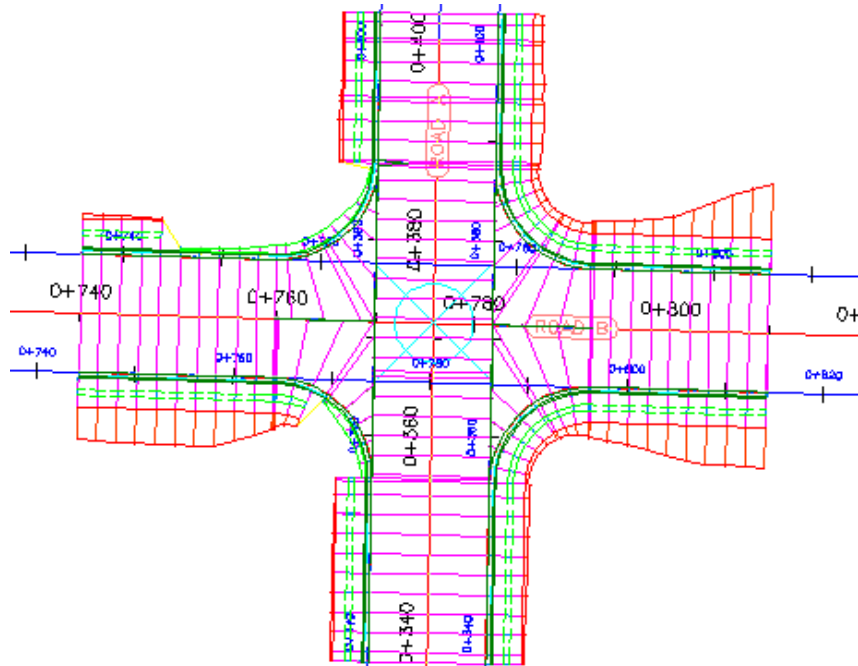
A corridor is displayed in the intersection area.







Modify the corridor properties

- 1 In Toolspace, on the Prospector tab, expand the  Corridors and  Intersections collections.

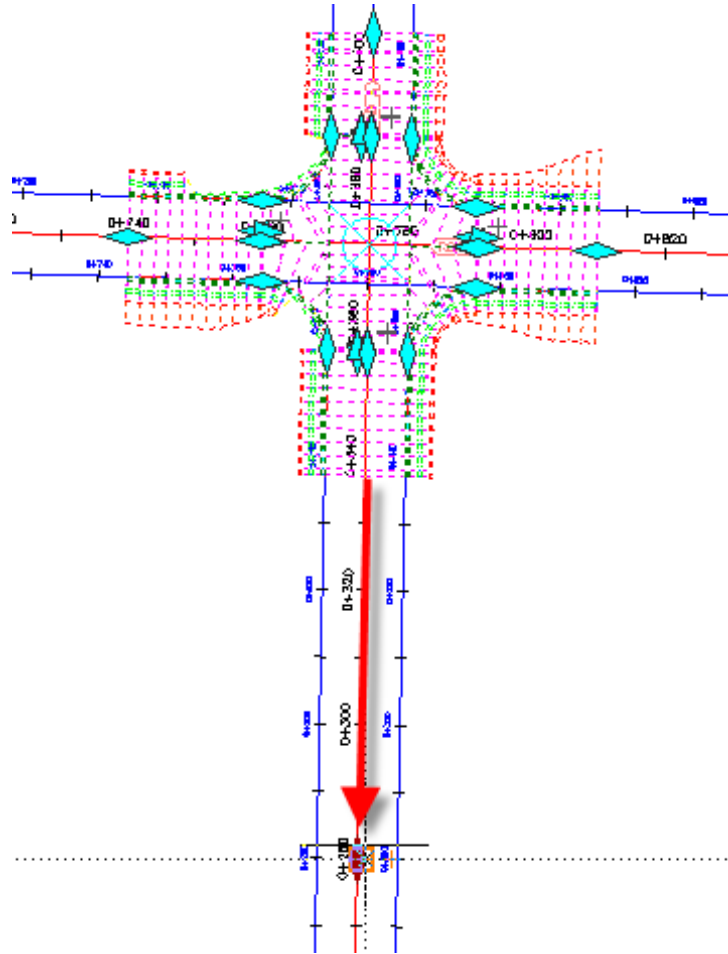
If either of the objects in these collections is  out of date, right-click the object and select Rebuild.

- 2 Select the corridor that is in the intersection area.
- 3 Select the  grip that is at the bottom of the intersection. Drag the grip down. Click to place the grip several hundred meters to the south.



- 4 Click Corridor tab  Modify Corridor panel  Corridor Properties drop-down  Corridor Properties.
- 5 In the Corridor Properties dialog box, on the Parameters tab, click  Select Region From Drawing.

- 6 In the drawing, click the bottom of the corridor.

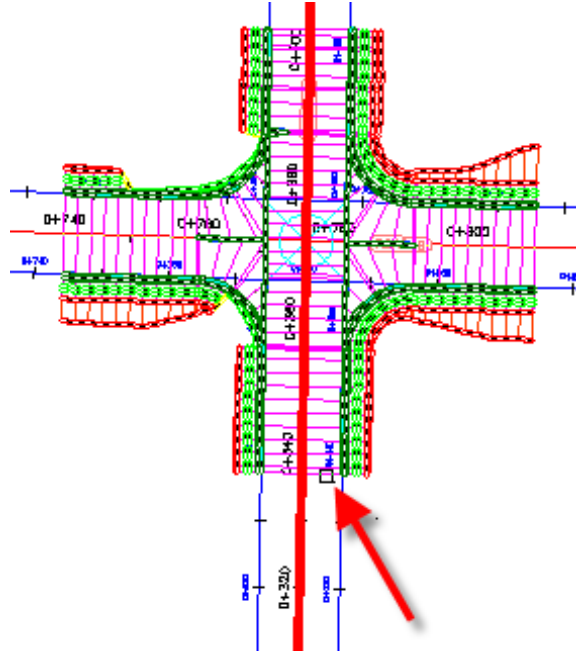

The specified region is highlighted in the Corridor Properties dialog box.

- 7 In the highlighted row, in the Frequency column, click .
- 8 In the Frequency To Apply Assemblies dialog box, under Apply Assembly, specify the following parameters:
- Along Tangents: 10
 - Along Curves: 5
 - Along Spirals: 5
 - Along Profile Curves: 5
- 9 Click OK twice.
- The corridor is rebuilt. The corridor extends further to the south. In the extended region, the assemblies are further apart than the intersection regions.

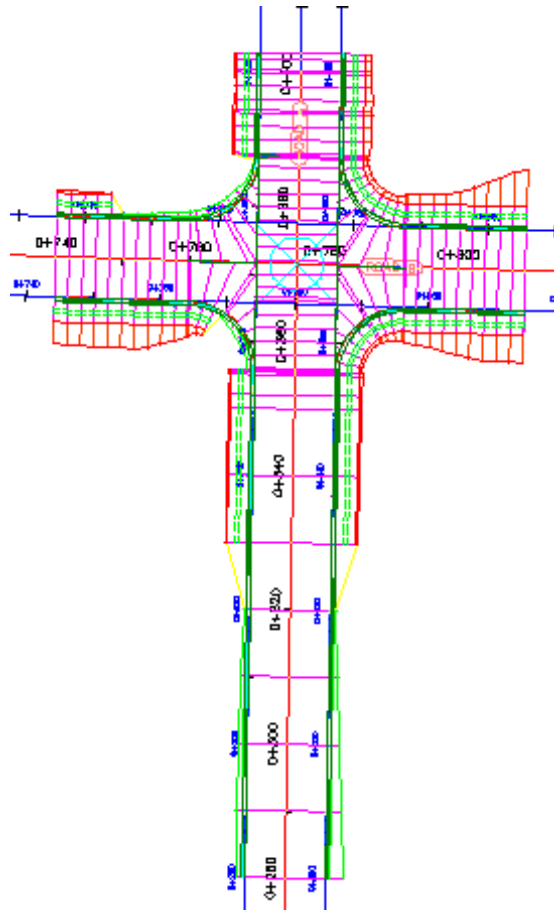

Recreate the corridor regions

- 1 Select the intersection marker.
- 2 Click Intersection tab ► Modify panel ►  Recreate Corridor Regions.
- 3 In the Intersection Corridor Regions dialog box, under Apply An Assembly Set, click Browse.
- 4 In the Select Assembly Set File dialog box, navigate to the [Assemblies folder](#) (page 819).
- 5 Select *_Autodesk (Metric) Assembly Sets.xml*. Click Open.

This is the assembly set that you used to create the corridor. However, Intersection Corridor Regions dialog box enables you to specify another assembly set, or individual assemblies, with which to create the corridor.

6 Click Recreate.

The corridor is recreated. Notice that the modifications that you made to the Road A baseline, including the assembly frequencies and region start station, returned to their original settings. This happened because the corridor was recreated using the parameters that were originally specified during the intersection creation process. Modifications that are made to the corridor in the intersection area are not retained when you recreate the corridor from the intersection object.

NOTE Corridor regions that are outside the intersection extents are not affected by the Recreate Corridor Regions command.

To continue to the next tutorial, go to [Working with Roundabouts](#) (page 538).

Tutorial: Working with Roundabouts

This tutorial demonstrates how to create and edit 2D roundabouts.

The roundabout approach roads, circulatory road, and turn slip lanes are defined by horizontal alignments, which are dynamic to the centerline alignments that you specify. You may create pavement markings, signs, and splitter islands as AutoCAD objects, which remain dynamic to the roundabout alignments.

For more information, see the AutoCAD Civil 3D Help topic *Understanding Roundabouts*.



Exercise 1: Creating a Roundabout

In this exercise, you specify a center point, the centerlines of the approach roads, and the geometric parameters from which to create a roundabout.

For more information, see the AutoCAD Civil 3D Help topic *Creating Roundabouts*.

Specify the roundabout center point and approach roads

- 1 Open *Roundabout-Create.dwg*, which is located in the [tutorial drawings folder](#) (page 819).

- 2 Click Home tab ► Create Design panel ►  Intersections drop-down ►  Create Roundabout.
- 3 To specify the roundabout center point, in the drawing, on the ROAD D alignment, click station 0+140.

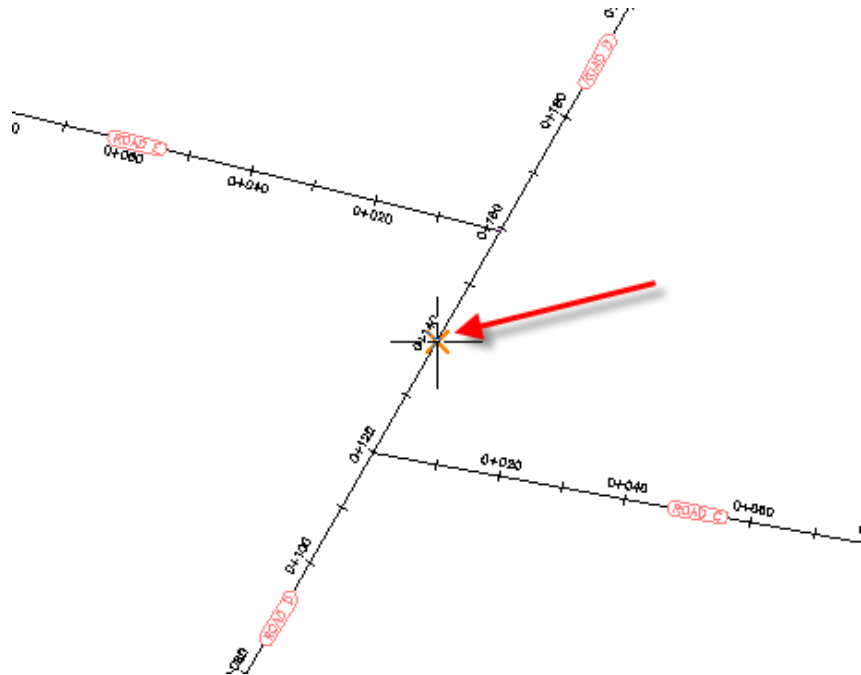

- 4 To specify the approach roads, click Roads C, D, and E as shown. Press Enter.

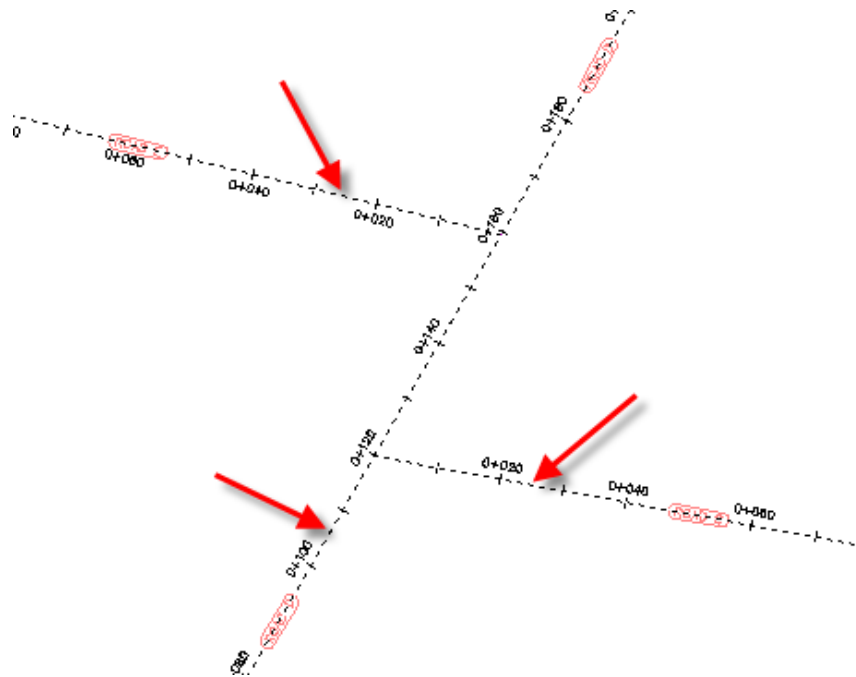

Specify the circulatory road parameters

- 1 In the Create Roundabout - Circulatory Road dialog box, under Drawing Standard, for Select Roundabout Standard, select US.
- 2 Under Predefined Parameters to Import, select RG = 20.

NOTE The Drawing Standard and Predefined Parameters To Import controls enable you to apply preset parameters to a roundabout. You will learn more in [Exercise 5: Working with Roundabout Design Standards and Presets](#) (page 560).

- 3 Under Roundabout Parameters, specify the following parameters:

NOTE When you hover the cursor over each control, notice that the applicable portion of the roundabout is highlighted in the preview graphic.

- Outer Radius: 20
- Circulatory Road Width: 8

- Apron Width: 3
- 4 Under Markings Parameters, specify the following parameters:
 - Outer Offset: Selected; 0.5
 - Inner Offset: Selected; 0.5
 - Marker Line Width: 0.3
 - Number Of Lanes To Mark: 2
 - Lane Marker Line Width: 0.2
 - Lane Marker Linetype: DASHED
 - 5 Specify the alignment parameters:
 - Site: None
 - Alignment Style: Roundabout - Circulatory Road
 - Alignment Layer: 0
 - Alignment Name Prefix: Roundabout
 - Alignment Label Set: Roundabout - Circulatory Road
 - 6 At the bottom of the dialog box, click Next.

Specify the approach road parameters

- 1 In the Create Roundabout - Approach Roads dialog box, under Predefined Parameters To Import, select RG = 20.

When you change this setting, the Approach Road Parameters section is populated with preset values. You will learn how to modify and save these values for later use in [Exercise 5: Working with Roundabout Design Standards and Presets](#) (page 560).
- 2 Specify the alignment parameters:
 - Alignment Style: Roundabout - Approach Road
 - Alignment Layer: 0
 - Alignment Name Prefix: Approach_WE
 - Alignment Label Set: Roundabout - Approach Road
- 3 At the top of the dialog box, click Apply To All.

This action applies the specified parameters to the other approach roads in the roundabout. At the top of the dialog box, you can use either the Previous and Next buttons, or the drop-down list, to examine the parameters of the other approach roads.

- 4 At the bottom of the dialog box, click Next.

Specify the island parameters

- 1 For Predefined Parameters To Import, select RG = 20.
- 2 Click Apply To All.
- 3 At the top of the Create Roundabout - Islands page, in the drop-down list, select South To North Approach.
- 4 Under Splitter Island Parameters, clear the Provide Crosswalk (Length) check box.

At the end of this exercise, you will examine the differences between the South To North Approach road and the others.

- 5 At the bottom of the dialog box, click Next.

Add signs and pavement markings

- 1 Under Signs, in the J5 row, for Leader Length, enter 10.
The Leader Length parameter enables you to place a leader line between the block that represents the top of the sign, and the block that represents the sign.
- 2 In the A25 row, for Distance, enter 60.
The Distance parameter enables you to place some signs a specific distance from the outer edge of the circulatory road. For this exercise, you will place a roundabout sign 60 meters before the driver enters the circulatory road, and a resume sign 50 meters after the driver exits the circulatory road.
- 3 In the AB6 row, for Distance, enter 50.
- 4 Under Pavement Markings, in the Yield Line row, under Linetype, select DASHED.
- 5 Under Crosswalk Markings, clear the following check boxes:

Draw

- Entry
- Exit

Break

- Break At Entry Island Edge
- Break At Exit Island Edge

NOTE Do not click Apply to All on this page. Later in this exercise, you will compare the default sign and marking parameters with the values you entered in the preceding steps.

Examine the roundabout components

- 1 Click Finish.

The roundabout is displayed in the drawing. Notice that the centerline alignments for the approach roads at Road E and Road C were created with a curve that provides a smooth transition from the parent alignment to the approach road.

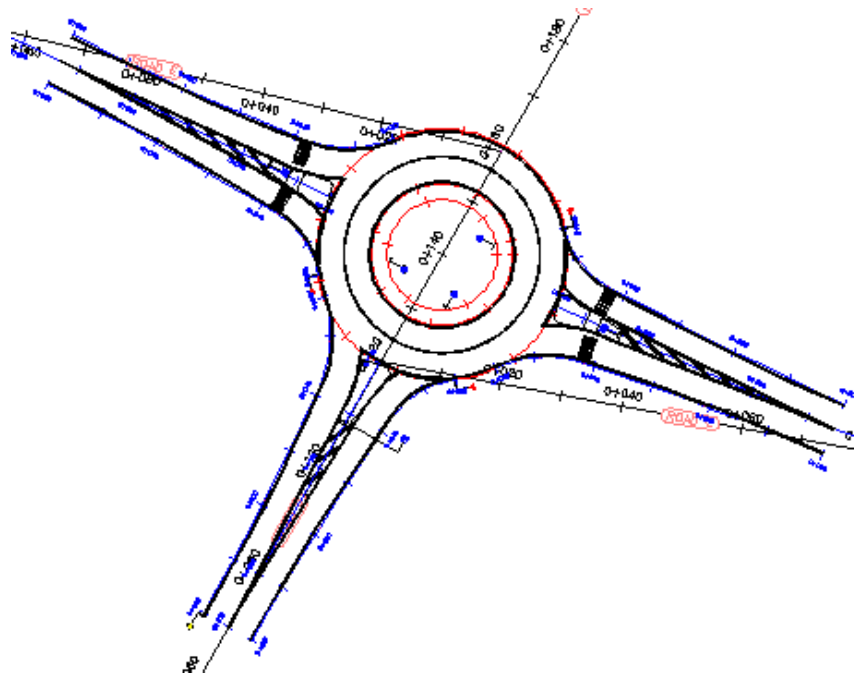

Notice that while you selected Road D as an approach road, only one end of it was created as an approach road. When an alignment passes through a roundabout center point, only the alignment end that you click is added as an approach road. You will learn how to add the other end as a separate approach road in [Exercise 2: Adding an Approach Road to a Roundabout](#) (page 546).

2 Zoom in to the South To North Approach road.

When you compare this approach road to the others, you see that, per the parameters you specified but did not apply to all the approach roads, these elements, which are shown in the following illustration, are different:

- 1 The splitter island is not divided.
- 2 The yield line is dashed.
- 3 The J5 (keep right) sign has a leader line that extends outside the roundabout geometry.
- 4 The A25 (approaching roundabout) sign is 60 meters from the circulatory road edge.

- The AB6 (exiting roundabout) sign is 50 meters from the circulatory road edge.

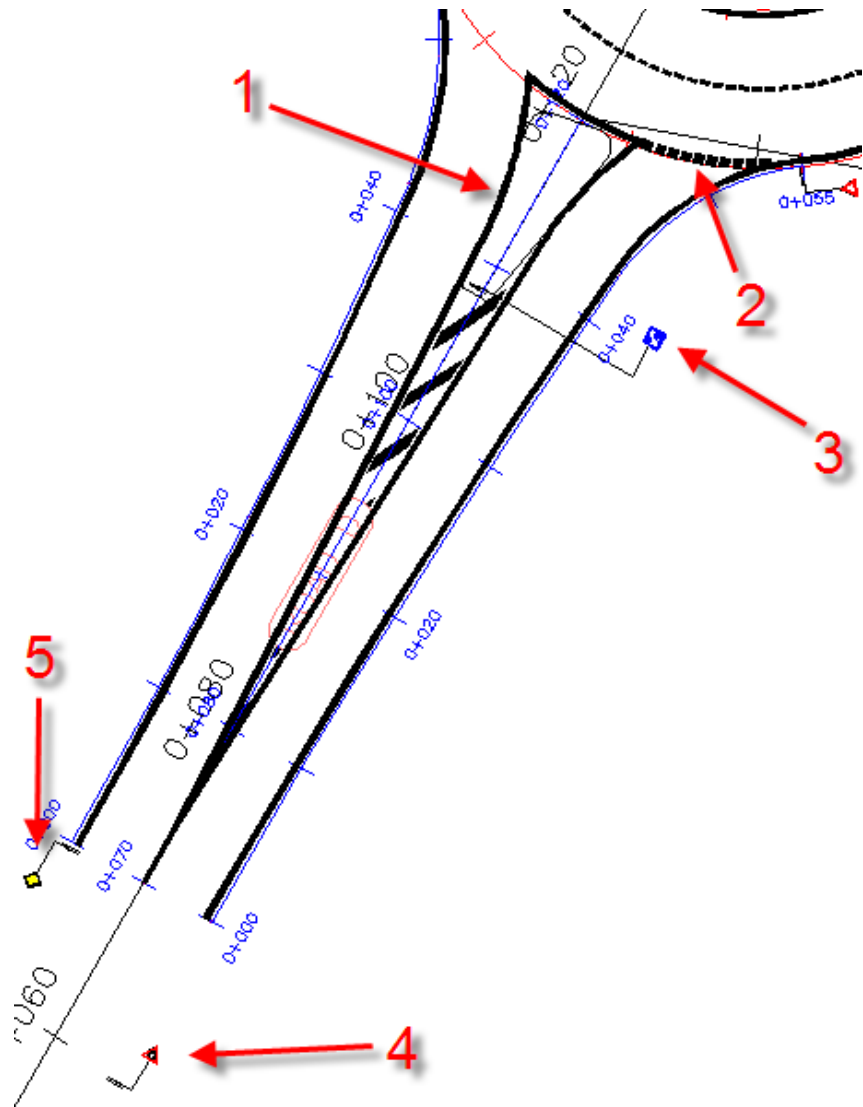

- In Toolspace, on the Prospector tab, expand the  Alignments collection.

The alignments that have a prefix of either Approach or Roundabout were automatically created during this exercise.



To continue this tutorial, go to [Exercise 2: Adding an Approach Road to a Roundabout](#) (page 546).

Exercise 2: Adding an Approach Road to a Roundabout

In this exercise, you create the geometry for another approach road that remains dynamic to both the roundabout and the specified centerline alignment.

For more information, see the AutoCAD Civil 3D Help topic *Adding Approach Roads*.

Select the approach road

- 1 Open *Roundabout-Approach-Add.dwg*, which is located in the [tutorial drawings folder](#) (page 819).
- 2 Click Home tab ► Create Design panel ►  Intersections drop-down ►  Add Approach.
- 3 Click the Roundabout_ISLAND alignment.

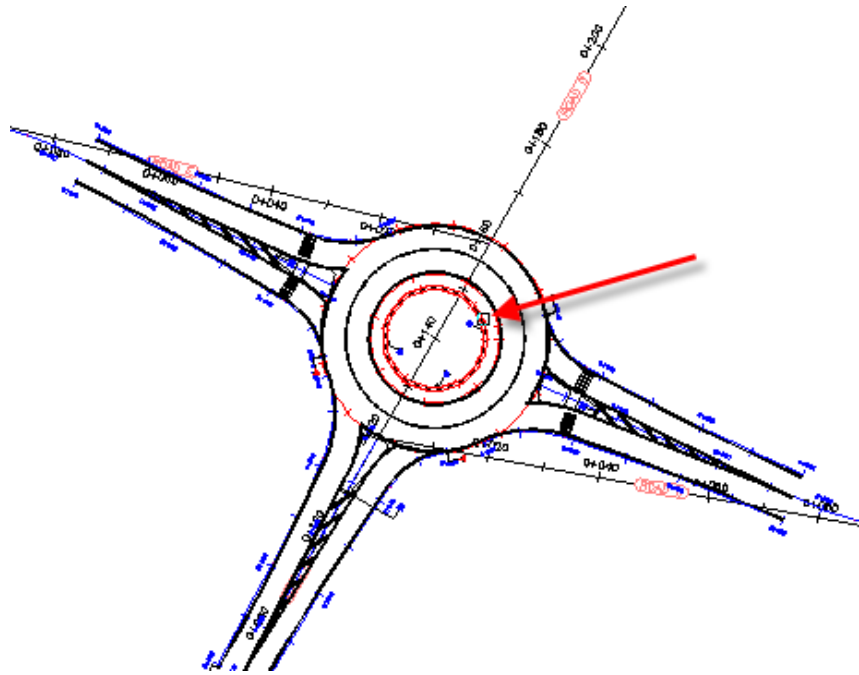

4 Click Road D, which is to the north of the roundabout.

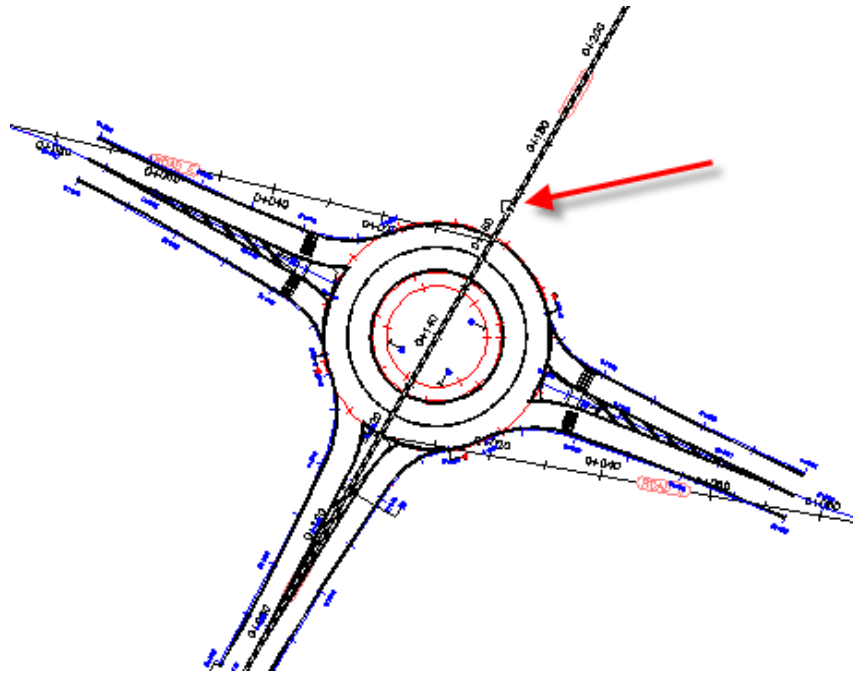

When the roundabout was created in [Exercise 1: Creating a Roundabout](#) (page 538), Road D was selected as an approach road, but only the southern end of it was added to the roundabout. When an alignment passes through a roundabout center point, only the alignment end that you click is added as an approach road. In this exercise, you add the other end to the roundabout.

- 5 Press Enter.

The Create Roundabout - Approach Roads dialog box is displayed. You use this dialog box to specify the geometry and alignment properties of the roads that meet at the roundabout.

Specify the approach road parameters

- 1 In the Create Roundabout - Approach Roads dialog box, under Predefined Parameters To Import, select RG = 20.

When you change this setting, the Approach Road Parameters section is populated with preset values. You will learn how to modify and save these values for later use in [Exercise 5: Working with Roundabout Design Standards and Presets](#) (page 560).

- 2 Under Approach Road Parameters, change the Entry Flare Length value to 75.
- 3 Specify the alignment parameters:
 - Alignment Style: Roundabout - Approach Road
 - Alignment Layer: 0
 - Alignment Name Prefix: Approach_SN
 - Alignment Label Set: Roundabout - Approach Road
- 4 At the bottom of the dialog box, click Next.

Specify the island parameters

- 1 For Predefined Parameters To Import, select RG = 20.
- 2 At the bottom of the dialog box, click Next.

Examine the roundabout components

NOTE On the Markings and Signs page, accept the default values.

- 1 Click Finish.
The approach road is displayed in the drawing.

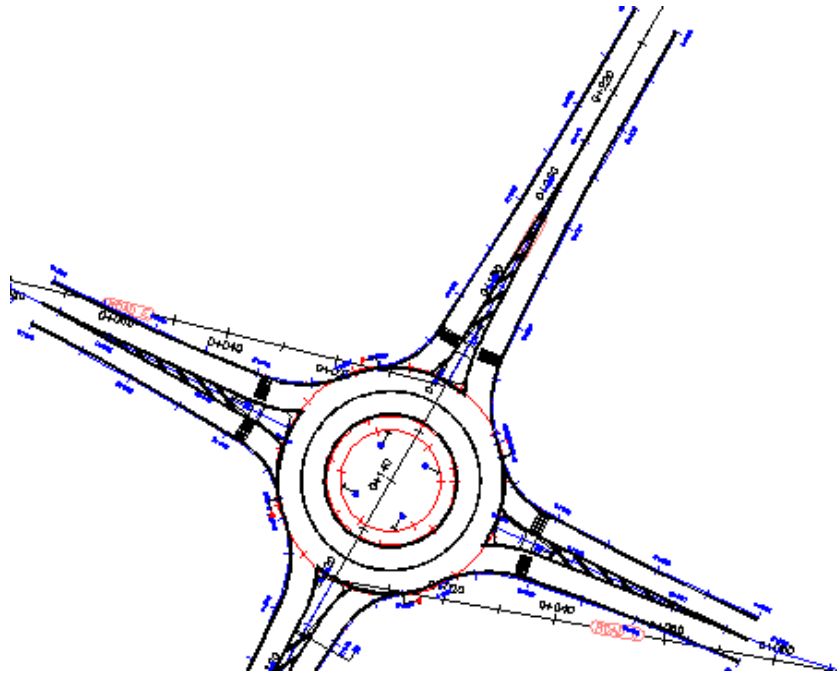

- 2 In Toolspace, on the Prospector tab, expand the  Alignments collection. The alignments that have a prefix of Approach_SN (1) were automatically created during this exercise.

To continue this tutorial, go to [Exercise 3: Adding a Turn Slip Lane to a Roundabout](#) (page 550).

Exercise 3: Adding a Turn Slip Lane to a Roundabout

In this exercise, you create the geometry for a turn slip lane, which allows vehicles to bypass the roundabout and turn from one approach road to another.

For more information, see the AutoCAD Civil 3D Help topic *Adding Slip Lanes*.

Select the entry and exit approach roads

- 1 Open *Roundabout-Slip Lane-Add.dwg*, which is located in the [tutorial drawings folder](#) (page 819).

- 2 Click Home tab ► Create Design panel ►  Intersections drop-down ►  Add Turn Slip Lane.
- 3 For the Entry Approach road, click the Approach_SN (1) alignment.

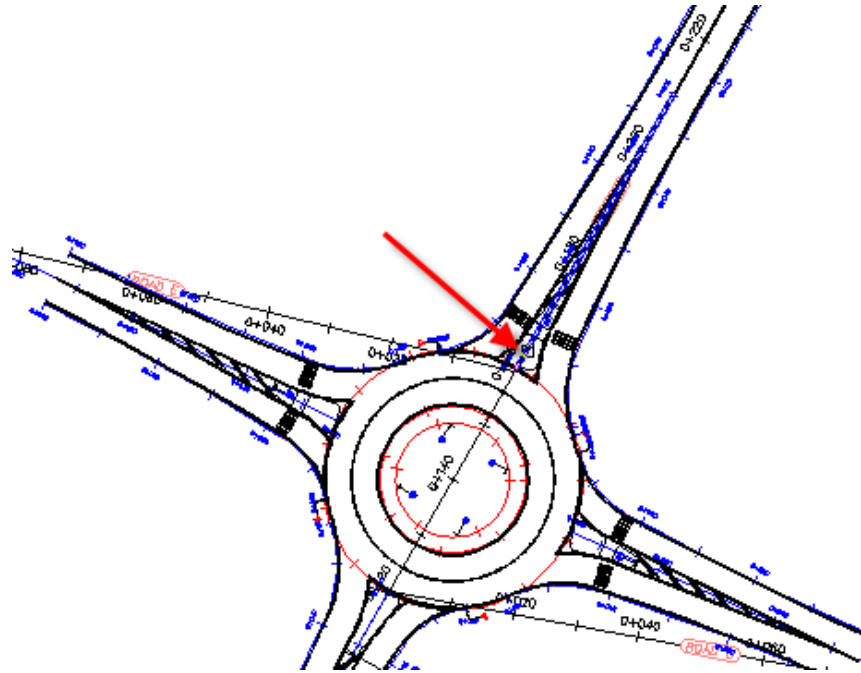

- 4 For the Exit Approach road, click the Approach_EW alignment.

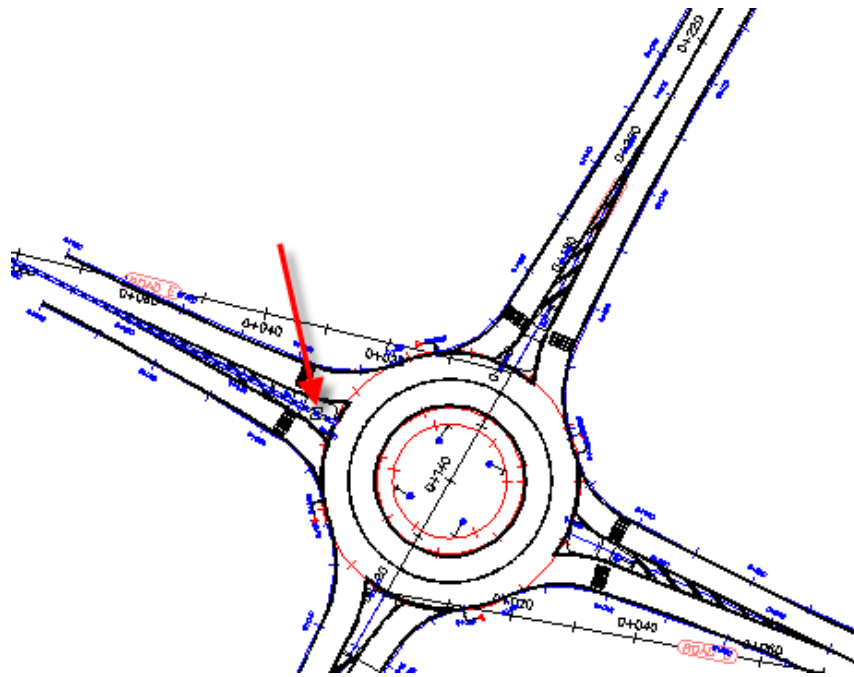

Specify the slip lane parameters

- 1 In the Draw Slip Lane dialog box, under Slip Lane Parameters, specify the following parameters:
 - Segmentation Line Length: 1
 - Length of Deceleration Lane: 20
 - Length of Acceleration Lane: 10
 - Lane Width: 4
 - Radius: 50
 - Taper Length: 20
- 2 Under Draw Pavement Markings, specify the following parameters:
 - Outer Edge: Selected; Continuous
 - Decelerating Transition Line: Cleared
 - Accelerating Transition Line: Cleared

- 3 Specify the alignment properties:
 - Alignment Style: Roundabout - Slip Lane
 - Alignment Layer: 0
 - Alignment Label Set: Roundabout - Slip Lane
 - Alignment Name Prefix: SlipLane
- 4 Click OK.

The slip lane is displayed in the drawing.

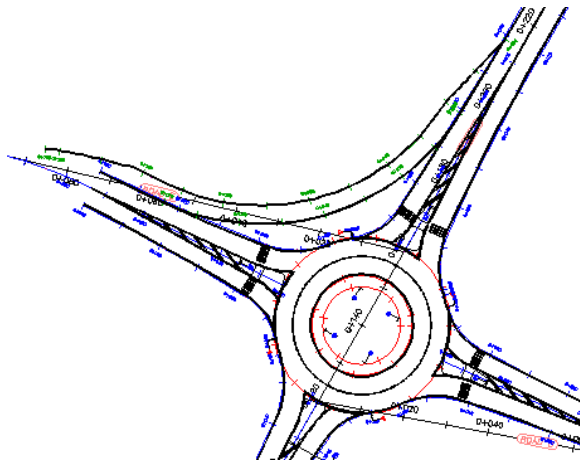

To continue this tutorial, go to [Exercise 4: Editing Roundabout Components](#) (page 553).



Exercise 4: Editing Roundabout Components

In this exercise, you edit the geometry of the approach roads, move the roundabout center point, and delete roundabout components.

For more information, see the AutoCAD Civil 3D Help topic *Editing Roundabouts*.

To edit approach road geometry

- 1 Open *Roundabout-Edit.dwg*, which is located in the [tutorial drawings folder](#) (page 819).

- 2 Click Modify tab ► Design panel ►  Intersection.
- 3 Click Intersection tab ► Modify Roundabout panel ►  Edit Roundabout.
- 4 Click the Approach_EW alignment.

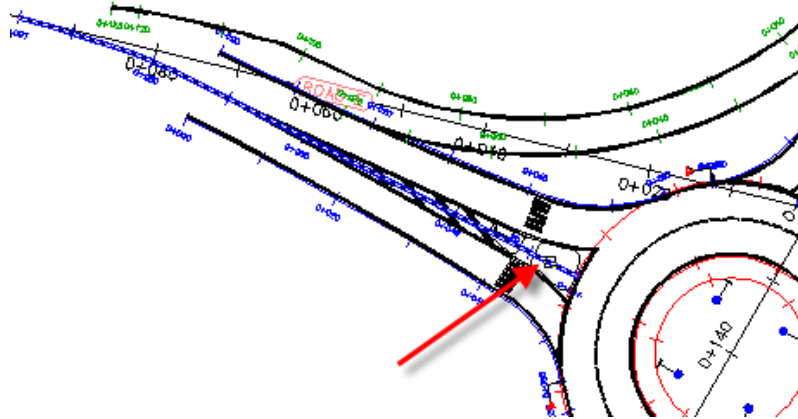

- 5 In the Create Roundabout - Approach Roads dialog box, under Approach Road Parameters, change the following parameters:
 - Exit Radius: 25
 - Entry Flare Length: 75
- 6 At the bottom of the dialog box, click Next.
- 7 In the Create Roundabout - Islands dialog box, under Construction Triangle Parameters, change the Length value to 75.
- 8 At the bottom of the dialog box, click Next. Click Finish.
The approach road is extended, the exit radius has increased, and linework for the islands and the pavement markings have been updated.

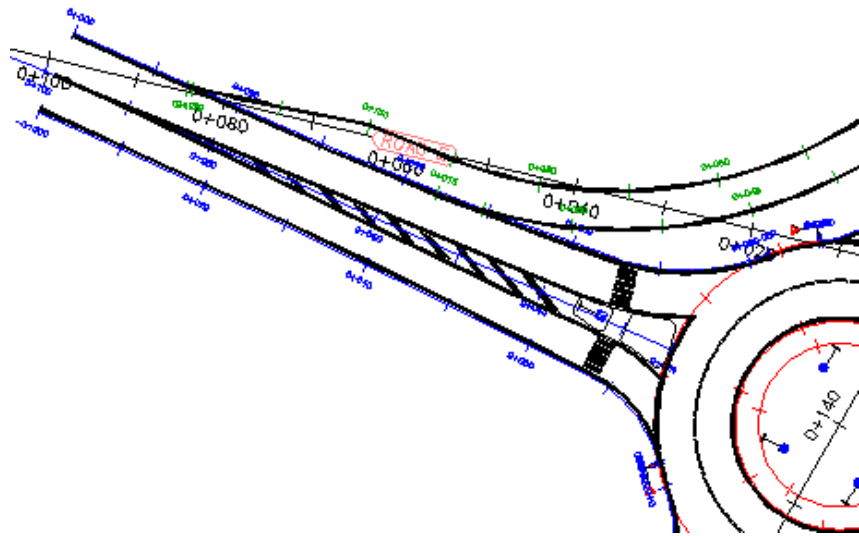

To edit roundabout location

- 1 Click Intersection tab ► Modify Roundabout panel ►  Edit Roundabout.
- 2 Click the Roundabout_ISLAND alignment.

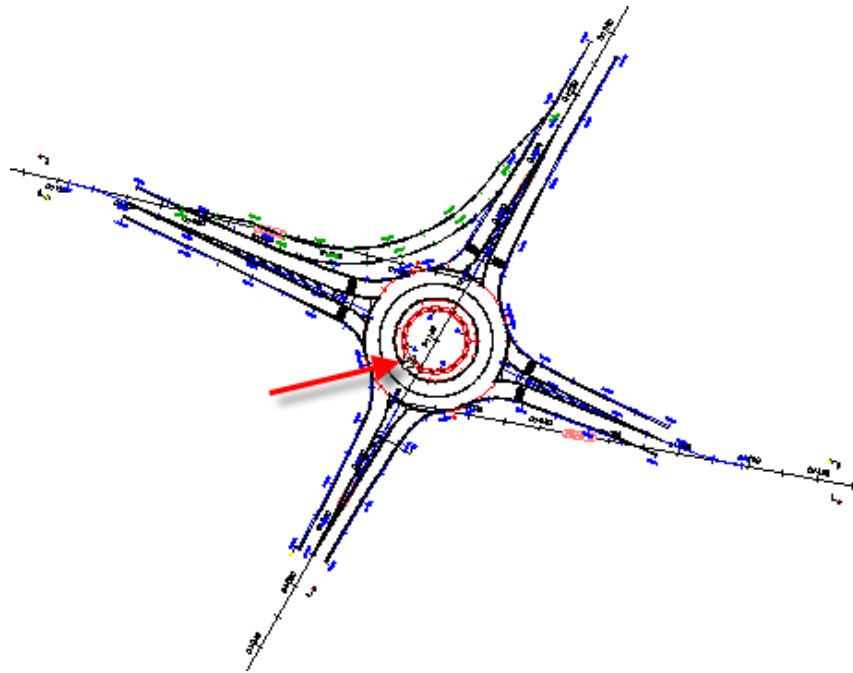

3 In the Create Roundabout - Circulatory Road dialog box, under

Roundabout Center Point, click .

4 In the drawing, on the Road D alignment, click near station 0+130.

NOTE Station 0+130 is not labeled, but the location is shown in the following image.

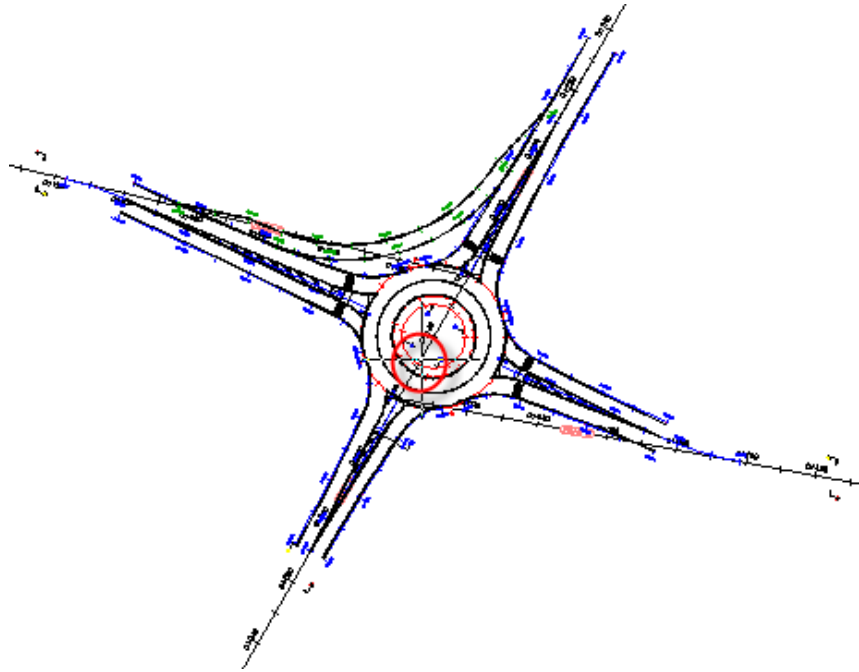

- 5 At the bottom of the dialog box, click Next three times. Click Finish.
The roundabout alignments and pavement markings are recreated around the new center point.

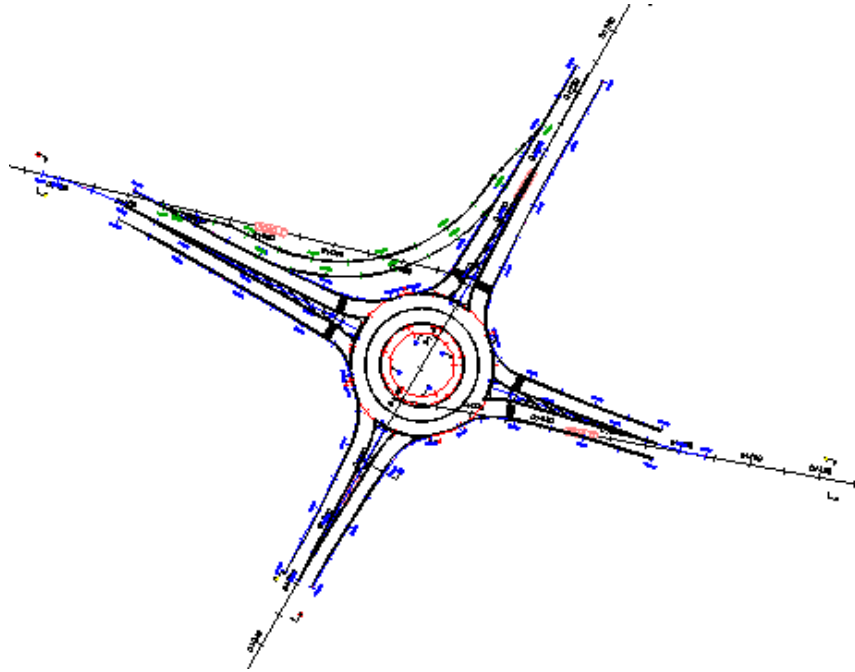

To delete roundabout components

- 1 Click Intersection tab ► Modify Roundabout panel ►  Delete Roundabout.
- 2 Click the Approach_SN (1) alignment.

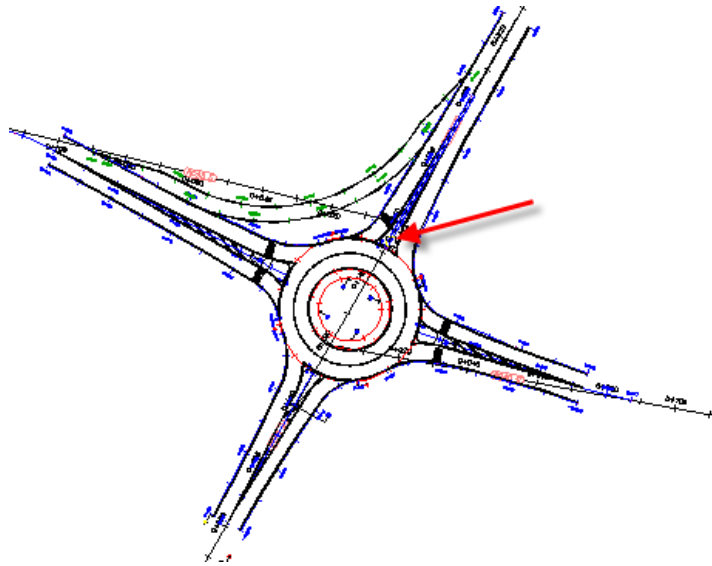

Both the approach road and the turn slip lane are deleted. The turn slip lane was deleted because its geometry was dependent upon the geometry of the approach roads to which it was attached.

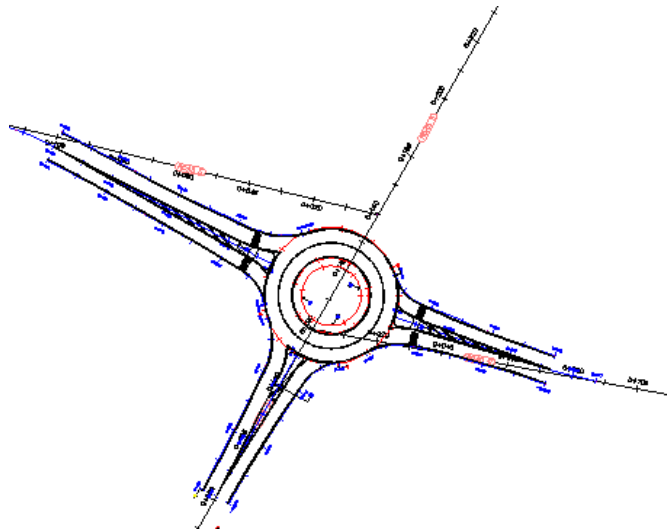

NOTE To delete the entire roundabout, click one of the circulatory road alignments while the Delete Roundabout command is active.

To continue this tutorial, go to [Exercise 5: Working with Roundabout Design Standards and Presets](#) (page 560).



Exercise 5: Working with Roundabout Design Standards and Presets

In this exercise, you save a group of geometric parameters as a preset that can be quickly applied to a roundabout.

Presets are saved in a design standards file, the contents of which you will examine at the end of this exercise.

For more information, see the AutoCAD Civil 3D Help topics *Roundabout Drawing Standards* and *Using Presets*.

Select a a baseline roundabout

- 1 Open *Roundabout-Preset.dwg*, which is located in the [tutorial drawings folder](#) (page 819).
- 2 Click Modify tab ► Design panel ►  Intersection.
- 3 Click Intersection tab ► Modify Roundabout panel ►  Edit Roundabout.
- 4 Click the Roundabout_ISLAND alignment.

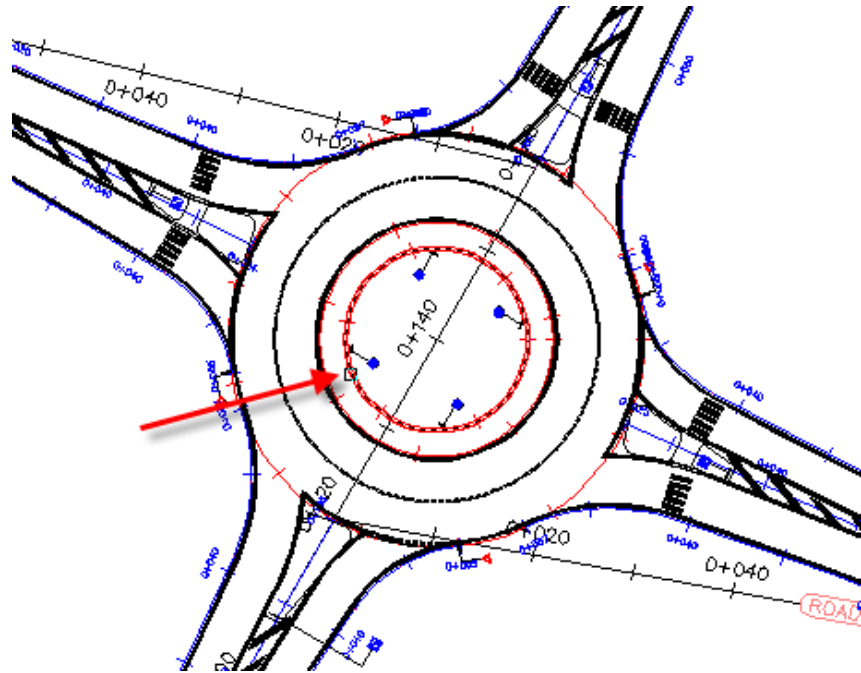

Specify circulatory road presets

- 1 In the Create Roundabout - Circulatory Road dialog box, under Predefined Parameters to Import, click .
- 2 In the Preset - Add dialog box, under Preset Name, enter R = 40.
- 3 Under Roundabout Parameters, enter the following parameters:
 - Outer Radius: 40
 - Circulatory Road Width: 10
 - Apron Width: 3
- 4 Under Markings Parameters, enter the following parameters:
 - Outer Offset: 0.5
 - Inner Offset: 0.5
 - Marker Line Width: 0.3

- Number of Lanes to Mark: 3
- Lane Marker Width: 0.2
- Lane Marker Linetype: DASHED

5 Click OK.

NOTE In the Create Roundabout - Circulatory Road dialog box, under Drawing Standard, the Roundabout Drawing Standard File is the xml file in which the presets are stored. You will examine the contents of this file at the end of this exercise.

6 At the bottom of the dialog box, click Next.

Specify approach road presets

- 1 In the Create Roundabout - Approach Roads dialog box, under Predefined Parameters to Import, click .
- 2 In the Preset - Add dialog box, under Preset Name, enter R = 40.
- 3 Under Approach Road Parameters, enter the following parameters:
 - Exit Road Width: 5
 - Exit Radius: 25
 - Exit Flare Length: 80
 - Exit Flare Type: Line
 - Width at Departure: 4.5
 - Entry Road Width: 4.5
 - Entry Radius: 20
 - Entry Flare Length: 80
 - Entry Flare Type: Line
 - Width at Approach: 4.25
- 4 Click OK.
- 5 In the Create Roundabout - Approach Roads dialog box, click Apply to All.

6 At the bottom of the dialog box, click Next.

Specify island presets

- 1 In the Create Roundabout - Islands dialog box, under Predefined Parameters to Import, click .
- 2 In the Preset - Add dialog box, under Preset Name, enter R = 40.
- 3 Under Construction Triangle Parameters, enter the following parameters:
 - Length: 60
 - Base: 4.5
- 4 Under Splitter Island Parameters, enter the following parameters:
 - Provide Crosswalk (Length): 3
 - Rounding at Exit: 1
 - Offset from Circle at Exit: 1
 - Offset at Exit: 0.5
 - Offset at Departure: 0.3
 - Rounding at Tip: 0.25
 - Island Total Length: 15
 - Island Base Length: 8
 - Rounding at Entry: 1
 - Offset from Circle at Entry: 0.5
 - Offset at Entry: 0.5
 - Offset at Approach: 1
 - Rounding at Crosswalk: 0.5
- 5 Click OK.
- 6 In the Create Roundabout - Islands dialog box, click Apply to All.
- 7 At the bottom of the dialog box, click Next. Click Finish.

The roundabout is updated to reflect the parameters that you defined for the preset. When you create another roundabout, the presets that you defined will be available.

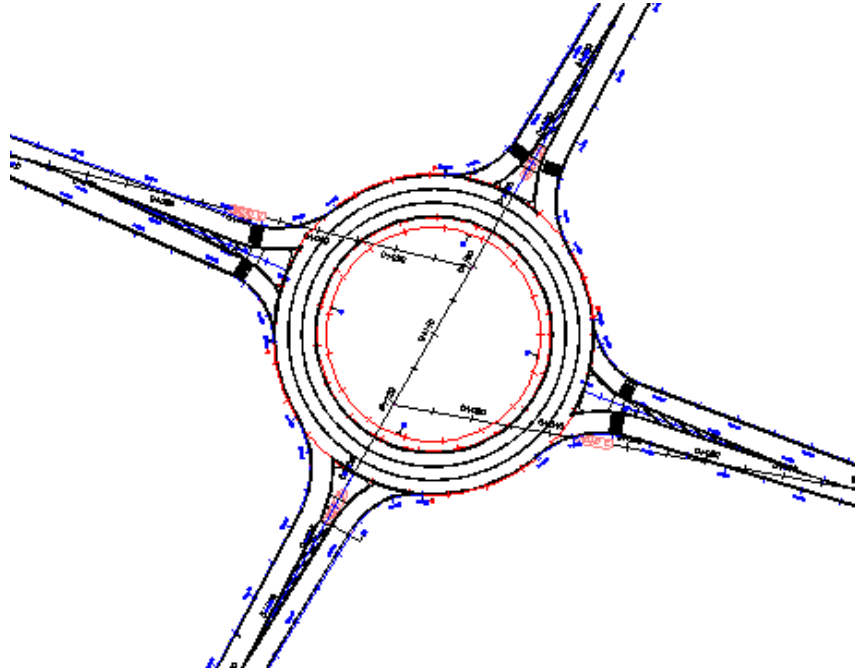

Examine the roundabout design standards file

- 1 Using Windows Explorer, navigate to the [Data\Corridor Design Standards\Metric folder](#) (page 819). Open the *Autodesk Civil 3D Metric Roundabouts Presets.xml* with your default Internet browser.
- 2 Under RoundaboutPresets ► StandardPresets ► US standardType="EN-US", examine the contents of the following blocks:
 - RoundaboutPreset name="R = 40"
 - ApproachPreset name="R = 40"
 - IslandsPreset name="R = 40"

These blocks contain the parameters you entered earlier in this exercise. If you are familiar with XML code, you can edit this file directly to add presets without using the Preset - Add dialog box in AutoCAD Civil 3D.

- 3 Close Windows Explorer and your Internet browser.

Edit a preset

- 1 Click Intersection tab ► Modify Roundabout panel ►  Edit Roundabout.
- 2 Click the Approach_SN alignment.

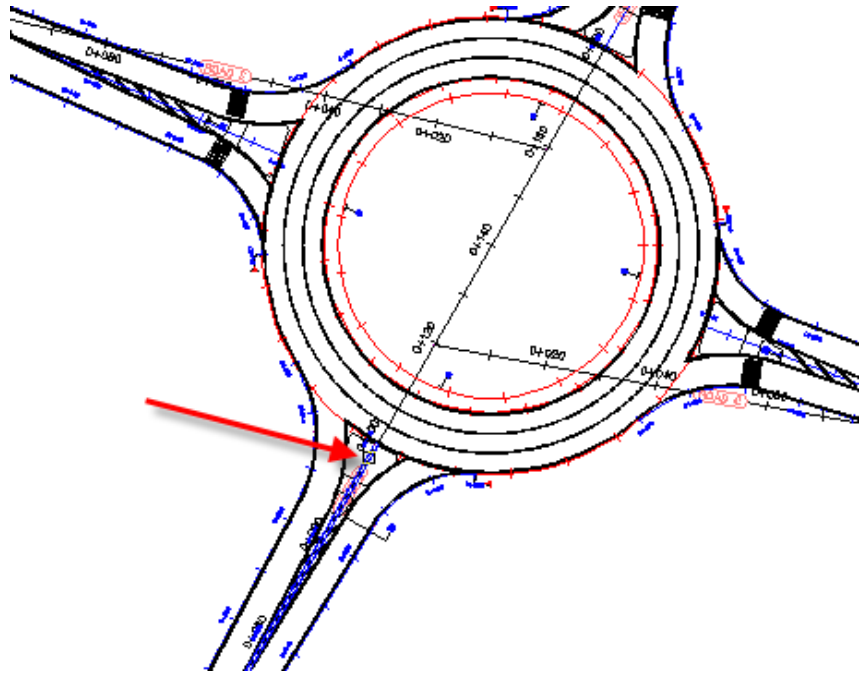

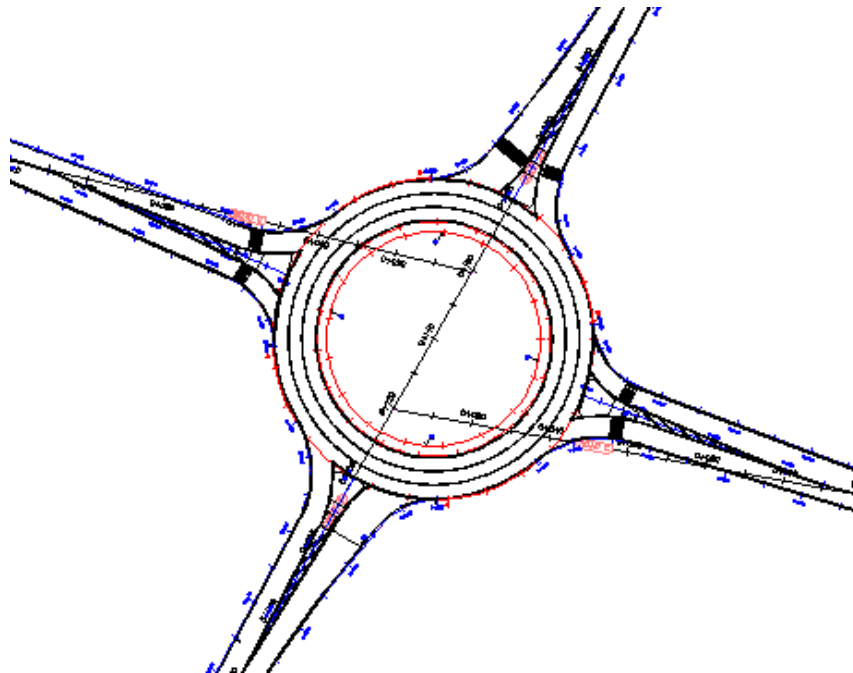

- 3 In the Create Roundabout - Approach Roads dialog box, under Predefined Parameters to Import, select R = 40. Click .
- 4 In the Preset - Edit dialog box, under Approach Road Parameters, change the following parameters:
 - Entry Road Width: 9
 - Entry Flare Type: Arc
- 5 Click OK.

- 6 At the top of the Create Roundabout - Approach Roads dialog box, use the drop-down list to select South to North Approach (1).
- 7 Under Predefined Parameters to Import, select R = 40.
- 8 At the bottom of the dialog box, click Next twice. Click Finish.
The approach roads to the north and south of the roundabout are updated to reflect the updated preset. The other approach roads were not affected because you did not apply the new preset to them.



Delete a preset

- 1 Click Intersection tab ► Modify Roundabout panel ►  Edit Roundabout.
- 2 Click the Approach_SN alignment.
- 3 In the Create Roundabout - Approach Roads dialog box, under Predefined Parameters to Import, select R = 40. Click  .
The preset is removed from the list.

- 4 Under Predefined Parameters to Import, select RG = 12. Click  .
The preset cannot be deleted because it was shipped with AutoCAD Civil 3D. Only user-defined presets may be edited or deleted.
- 5 Click OK.
- 6 In the Create Roundabout - Approach Roads dialog box, click Cancel.

Sections Tutorials

15

These tutorials will get you started working with sections and section views, which provide a view of the terrain cut at an angle across a linear feature, such as a proposed road.

Typically, sections are cut across the centerline alignment of a corridor. These sections are then plotted, either individually for a station, or as a group for a range of stations.

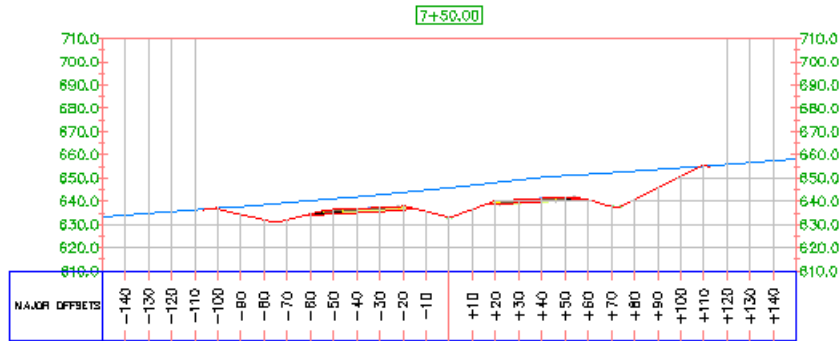

NOTE All drawings used in these tutorials are available in the [tutorial drawings folder](#) (page 819). If you want to save your work from these tutorials, save the drawings to the [My Civil Tutorial Data folder](#) (page 819) so that you do not overwrite the original drawings.

For more information, see the AutoCAD Civil 3D Help topic *Understanding Sections*.

Tutorial: Creating Section Views

This tutorial demonstrates how to display cross sections of the corridor model surfaces along the centerline alignment. You will create sample lines and then generate the sections.

Cross sections show elevations at sample lines, which are created perpendicular to an alignment. Sections can be derived from surfaces, corridor models, and corridor surfaces. Furthermore, they can be either dynamic or static. When a surface or corridor is modified, dynamic sections are automatically updated. A static section shows the elevations at the time it was created, but does not react to later geometry changes. Similarly, dynamic sample lines associated with an alignment move with the alignment if it is modified.

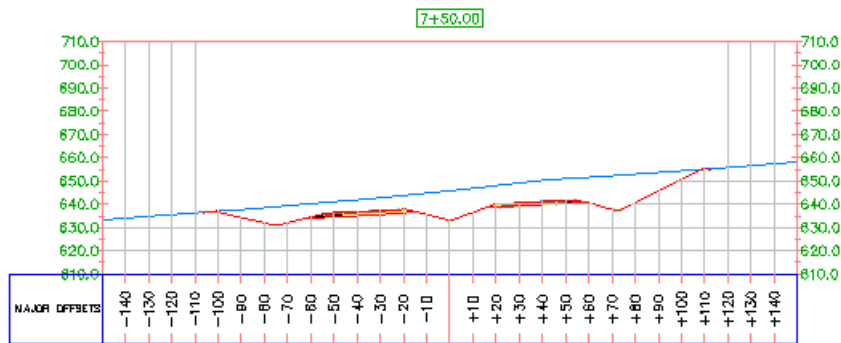

TIP You can use the workflow that is demonstrated in this tutorial to create section views from a corridor Xref. Section views created from an Xref can be dynamically linked to the corridor model; if the corridor model in the Xref drawing changes, the section views update automatically.

For more information, see the AutoCAD Civil 3D Help topic *Sections*.

Exercise 1: Creating Sample Lines

In this exercise, you will create a set of sample lines along the alignment.

The sample lines define the stations at which the cross sections are cut, and also the width of the sections to the left and right of the alignment. A set of sample lines is stored in a Sample Line Group for the alignment. Each sample line group has a unique name. Each line within the group also has a unique name.



For more information, see the AutoCAD Civil 3D Help topic *Creating and Editing Sample Lines and Sections*.

Create sample lines

- 1 Open *Sections-Sample-Lines-Create.dwg*, which is located in the [tutorial drawings folder](#) (page 819).

- 2 Click Home tab ► Profile & Section Views panel ► Sample Lines .
- 3 At the Select An Alignment prompt, press Enter.
- 4 In the Select Alignment dialog box, select Centerline (1). Click OK.
The Create Sample Line Group dialog box is displayed. This dialog box defines the characteristics of the sample line group. The templates shipped with AutoCAD Civil 3D contain pre-defined line styles and line label styles for the sample lines.
- 5 In the top portion of the Create Sample Line Group dialog box, specify the following parameters:
 - Sample Line Style: Road Sample Lines
 - Sample Line Label Style: Name & Section Marks
- 6 Under Select Data Sources To Sample, verify that the Sample check boxes are selected for all entries in the table.
Data sources may include surfaces, corridor models, and corridor surfaces. Each surface and corridor surface results in a single cross-sectional string. Using the corridor model as a source includes all of the points, links, and shapes in the model.
- 7 Set the Section Styles to the following:

NOTE You can double-click a Style cell in the table to select the Section Style.

 - EG: Existing Ground
 - Corridor - (1): All Codes
 - Corridor - (1) Top: Finished Grade
 - Corridor - (1) Datum: Finished Grade
- 8 Click OK.
The Sample Line Tools toolbar is displayed. A Specify Station prompt is displayed on the command line.
- 9 On the toolbar, click the arrow next to the  Sample Line Creation Methods button. Click  From Corridor Stations.
This option creates a sample line at each station found in the corridor model.

- 10 In the Create Sample Lines - From Corridor Stations dialog box, specify the following parameters:
 - Left Swath Width: 150
 - Right Swath Width: 150
- 11 Click OK.

The sample lines are created, and the Sample Line Tools toolbar is available for defining additional lines, if desired.

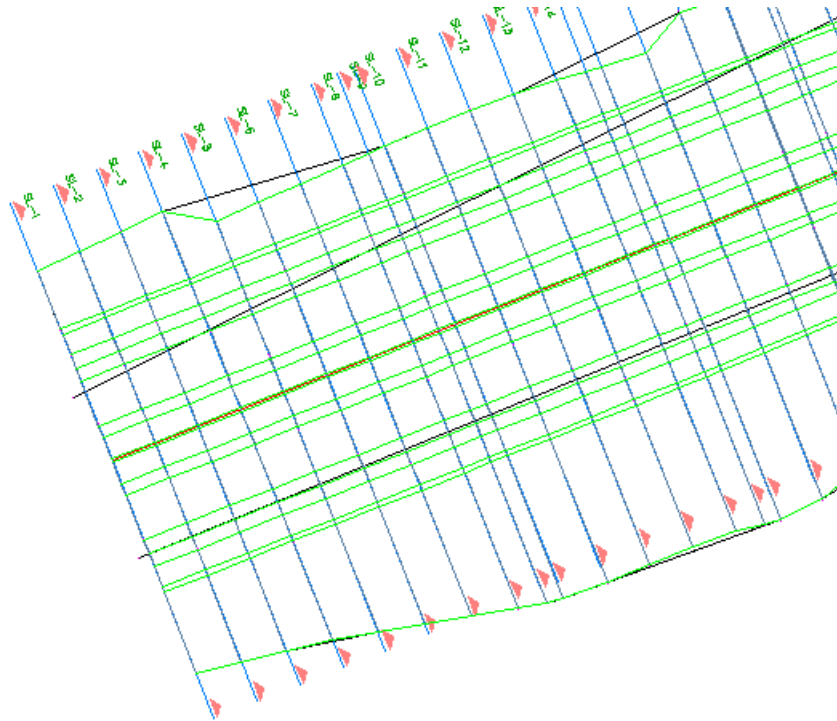

- 12 Close the Sample Lines Tools toolbar.

To continue this tutorial, go to [Exercise 2: Creating Section Views](#) (page 572).

Exercise 2: Creating Section Views

In this exercise, you will create a section view for a range of sample lines.

First, you will modify some of the settings that apply to section views.

For more information, see the AutoCAD Civil 3D Help topic *Creating and Editing Section Views*.

This exercise continues from [Exercise 1: Creating Sample Lines](#) (page 570).

Modify the group plot style

- 1 Open *Sections-Views-Create.dwg*, which is located in the [tutorial drawings folder](#) (page 819).
- 2 In Toolspace, on the Settings tab, expand the Section View ► Group Plot Styles collection. Select the Basic style. Right-click. Click Edit.
- 3 In the Group Plot Style dialog box, click the Display tab.
- 4 Under Component Display, in the Print Area row, change the Color to Red.
These colors make it easy to identify the extents of the sheet, as well as the portion of the sheet that contains the section views. You will observe these components when you create the section views later in this exercise.
- 5 Click OK.

Specify basic section view parameters



- 1 Click Home tab ► Profile & Section Views panel ► Section Views drop-down ► Create Multiple Views .
- 2 In the Create Multiple Section Views wizard, on the General page, specify the following parameters:
 - Select Alignment: Centerline (1)
 - Sample Line Group Name: SLG-1
 - Station Range: User Specified
 - Start: 0+00.00
 - End: 10+00.00
 - Section View Style: Road Section
- 3 Click Next.

Specify a plot style and a layout template

On the Section Placement page, you specify how the section views are displayed and arranged in the sheets. Select a template, viewport scale, and the group plot style.

- 1 Under Placement Options, select Production.

NOTE The Draft option creates section views in the current drawing only. You cannot generate sheets from Draft section views.

- 2 Under Template for Cross Section Sheet, click .
- 3 In the Select Layout As Sheet Template dialog box, click .
- 4 In the [Local Template folder](#) (page 819), make sure that *Civil 3D (Imperial) Section.dwt* is selected. Click Open.
- 5 In the Select Layout As Sheet Template dialog box, under Select A Layout To Create New Sheets, select ARCH D Section 40 Scale.
- 6 Click OK.
- 7 On the Create Multiple Section Views wizard, under Group Plot Style, select Basic.
- 8 Click Next.

Specify the section view offsets

- 1 On the Offset Range page, under Offset Range, select Automatic.
Notice that the Left and Right values are 150. This is the sample line swath width value that you specified in [Exercise 1: Creating Sample Lines](#) (page 570).
- 2 Click Next.

Specify the height of the section views

- 1 On the Elevation Range page, specify the following parameters:
 - User Specified: Selected
 - Height: 100.000'
 - Section Views Height Option: Follow A Section

- Select Section: EG

These settings specify that all section views will be 100-feet tall and the elevation will follow the EG surface elevation.

- 2 Click Next.

Specify the sampled sections and labels

The Section Display Options page specifies the object and label styles for the sampled objects. In this exercise, you will suppress the labels.

- 1 On the Section Display Options page, in the Clip Grid column, click the Corridor - (1) Top row.
- 2 In the EG row, click the value in the Change Labels column.
- 3 In the Select Style Set dialog box, select No Labels. Click OK.
- 4 Repeat Steps 2 and 3 to apply the No Labels style to the Corridor - (1) Top and Corridor - (1) Datum surfaces.
- 5 Click Next.

Specify the data band settings

- 1 On the Data Bands page, under Select Band Set, select Major Station.
- 2 In the Set Band Properties area, specify the following parameters:
 - Surface1: Corridor (1) - Top
 - Surface 2: Corridor (1) - Datum

Create and examine the section views

- 1 Click Create Section Views.
- 2 At the Identify Section View Origin prompt, select a point in the top viewport.
- 3 Zoom in to one of the sheets.

Groups of section views are arranged inside two rectangles. You specified the color of the rectangles at the beginning of this exercise:

 - The blue rectangle represents the extents of the sheet.

- The red rectangle represents the extents of the printable area in which the section views are placed.

When you create section sheets, the area between the red and blue rectangles contains the title block, border, and other information that is contained in the plan production template you selected.

You will create section sheets in the [Creating Section Sheets](#) (page 814) exercise.

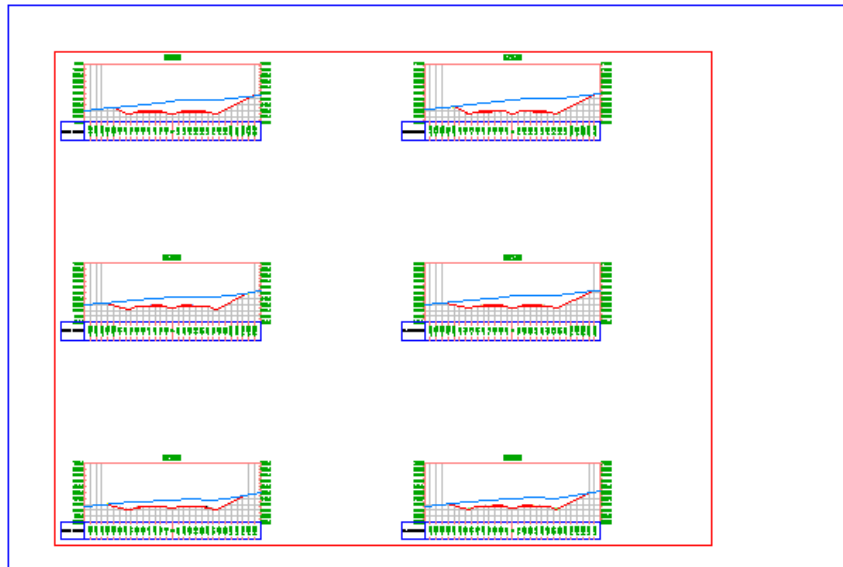

4 Zoom in to one of the section views.

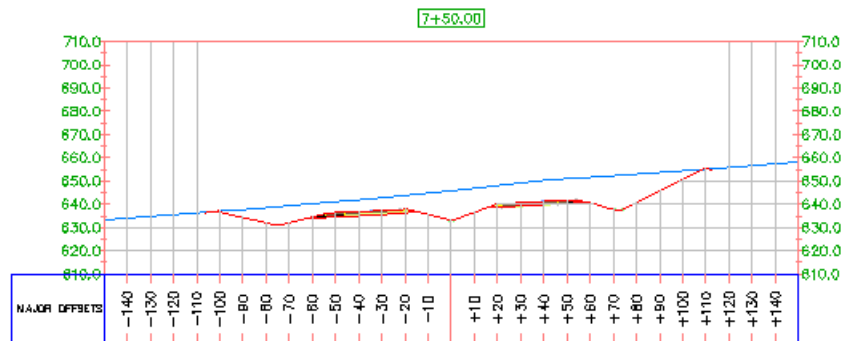

To continue to the next tutorial, go to [Adding Data to a Section View](#) (page 577).

Tutorial: Adding Data to a Section View

This tutorial demonstrates how to add annotative data to a section view.

For more information, see the AutoCAD Civil 3D Help topic *Sections*.

Exercise 1: Projecting an Object onto a Section View

In this exercise, you will project multi-view blocks and 3D polylines from plan view onto section views.

A variety of AutoCAD and AutoCAD Civil 3D objects can be projected into a section view. However, linear objects, such as 3D polylines and feature lines, are represented as a marker that indicates the point location where the object crosses the sample line in plan.

For more information, see the AutoCAD Civil 3D Help topic *Adding Projected Objects to a Section View*.

Project objects onto multiple section views

- 1 Open *Section-Project-Objects.dwg*, which is located in the [tutorial drawings folder](#) (page 819).

A proposed corridor and a series of section views are displayed in two viewports in the drawing. Along the corridor, several other objects are visible:

- Red polylines on either side of the corridor represent the corridor right-of-way.
- A blue polyline along the right side of the corridor represents a fence.
- AutoCAD blocks that represent utility poles are displayed along the right side of the corridor.
- Multi-view blocks that represent a line of trees are displayed along the left side of the corridor.

- 2 Click Home tab ► Profile & Section Views panel ► Section Views drop-down ►  Project Objects To Multiple Section Views.
- 3 In the top viewport, select one of the section views.

The Project Objects To Multiple Section Views dialog box is displayed. Under Projection Rules, you may specify the proximity area for non-linear objects to be projected.

- 4 Under Projection Rules, select By Distance.
This option specifies that objects that are a specified distance before or after a sample line are projected.
- 5 For Distance Before and Distance After, enter 50.
- 6 In the table, under Name, clear all check boxes except Blocks and 3D Polylines.
- 7 In the Blocks row, specify the following parameters:
 - Style: Projection Without Exaggeration
 - Elevation Options: Surface ► Corridor - (1) Surface - (1)
 - Label Style: Offset and Elevation
- 8 In the Blocks and 3D Polylines rows, specify the following parameters:
 - Style: Projection Without Exaggeration
 - Elevation Options: Surface ► EG
 - Label Style: Offset and Elevation
- 9 Click OK.
The 3D polylines are displayed on the section views. The labels annotate the offset and elevation at which each object is projected.

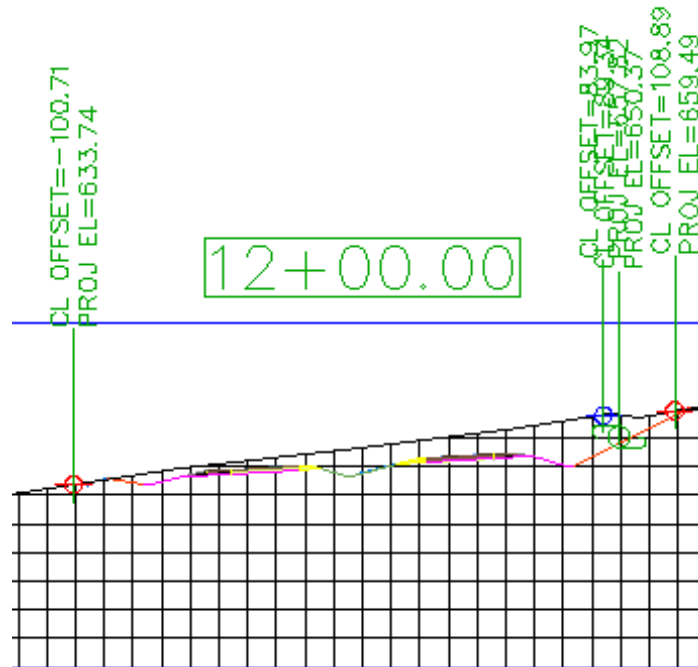

- 10 In the bottom viewport, zoom in to the area between stations 7+00.00 and 13+00.00.

At sample lines SL-07, SL-08, SL-12, and SL-13, examine the proximity of the utility pole blocks. You specified a distance of 50 feet as the projection distance, which means that specified objects that are within 50 feet of a sample line will be projected.

In the top viewport, notice that a utility pole block does not appear in section view 13+00.00. This section view does not display a utility pole block because one does not appear within 50 feet before or after the sample line.

Project objects onto a single section view

- 1 In the top viewport, pan and zoom until you see section 13+00.00.
- 2 Click Home tab ► Profile & Section Views panel ► Section Views drop-down ► Project Objects To Section View .

- 3 In the bottom viewport, select the multi-view block that represents a tree at station 13+00.

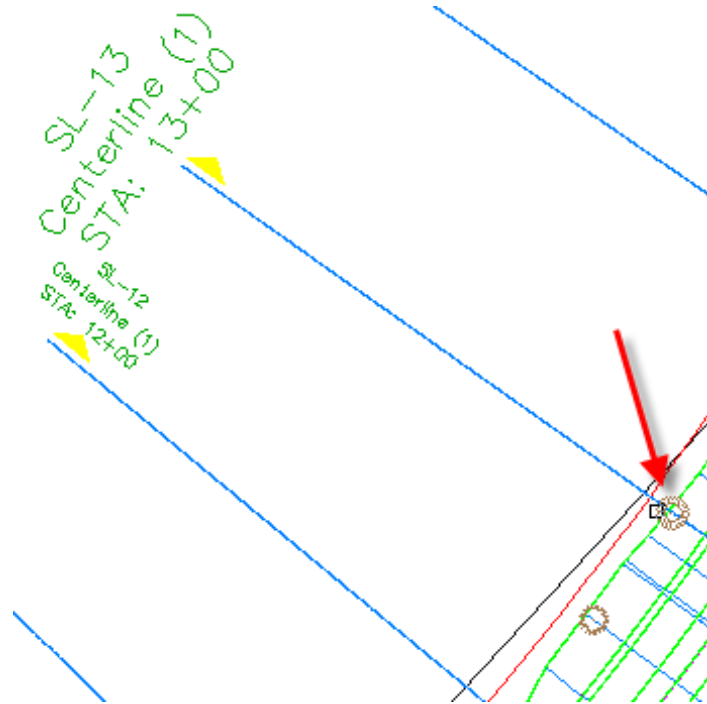

- 4 Press Enter.
- 5 In the top viewport, click section view 13+00.
- 6 In the Project Objects To Section View dialog box, click  <Set All> in each column to specify the following parameters:
 - Style: Projection Without Exaggeration
 - Elevation Options: Surface ► EG
 - Label Style: Offset and Elevation
- 7 Click OK.
The block is displayed on the section view.

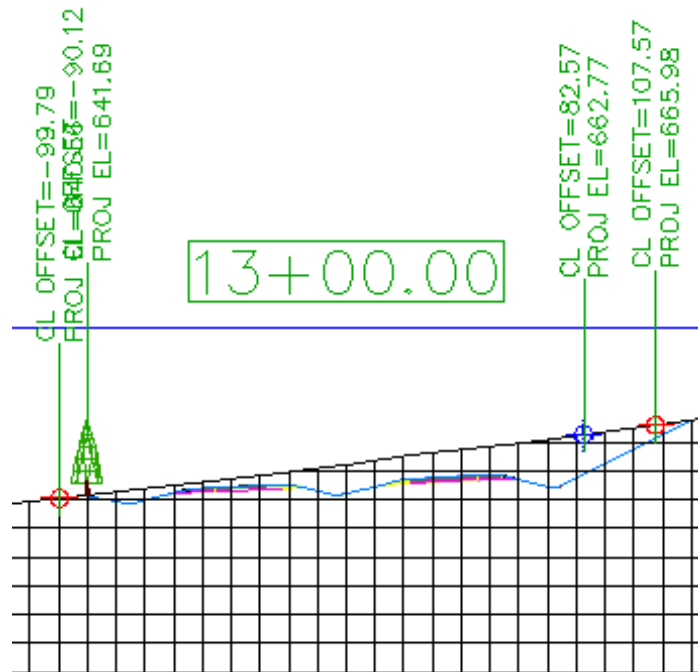

Edit the elevation of a projected object

In the following steps, you will change the elevation of the tree and fence marker so that they reflect the elevation of the corridor surface.

- 1 In the top viewport, click the blue marker that indicates the elevation of the fence.

When you select the marker in the section view, notice that the blue 3D polyline in plan is highlighted.



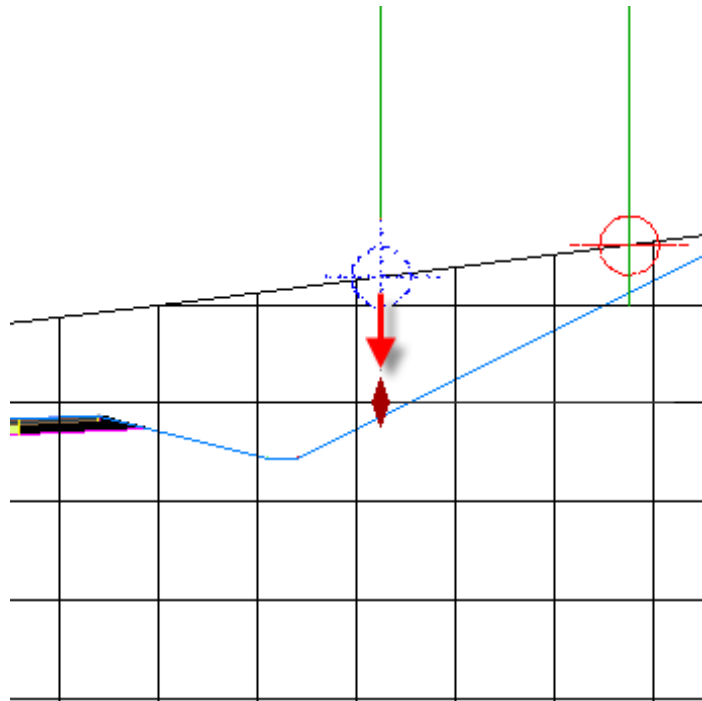

- 2 Click the  grip. Drag the grip down to change the elevation of the 3D polyline.



When you click to place the grip, you are notified that the elevation option for the polyline will be changed to manual. This option enables you to specify an elevation value for an object at the current station. The elevation value is applied in the current section view, but the value does not affect the object in plan view.



- 3 In the task dialog box, click No.
- 4 Press Esc.
- 5 Select section view 13+00. Right-click. Click Section View Properties.
The Projections tab is displayed on the Section View Properties dialog box. You can use the controls on this tab to change the parameters you used when you projected objects onto the section view.

NOTE Like other AutoCAD Civil 3D labels, label parameters are changed by selecting the desired label, and then using the Labels contextual tab on the ribbon.

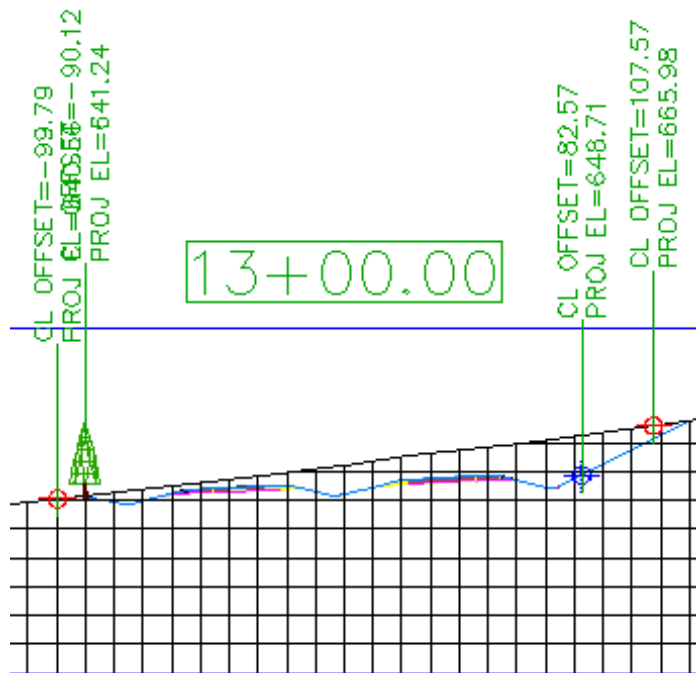
- 6 In the Section View Properties dialog box, on the Projections tab, under  3D Polylines, select the 3D Polyline- 23 row.
When you select the row, notice that the corresponding object is highlighted in both plan and section views.
- 7 In the Elevation Options column, change the value to  Surface  Corridor - (1) Surface - (1).
- 8 Repeat Steps 6 and 7 to change the elevation of  Multi View Blocks  Eastern White Pine- 21 to reference Corridor - (1) Surface - (1).
- 9 Click OK.
In the section view, notice that the fence marker and tree are now at the corridor surface elevation.



Project an object that is at a different station

- 1 In the bottom viewport, pan until you can see sample lines SL-3 and SL-8.
- 2 Click Home tab ► Profile & Section Views panel ► Section Views drop-down ► Project Objects To Section View .
- 3 In the bottom viewport, select the blocks that represents trees at SL-3 and SL-8.
- 4 Press Enter.
- 5 In the top viewport, click section view 13+00.
- 6 In the Project Objects To Section View dialog box, click  <Set All> in each column to specify the following parameters:
 - Style: Projection Without Exaggeration
 - Elevation Options: Surface ► Corridor - (1) Surface - (1)
 - Label Style: Offset Elevation
- 7 Click OK.

The tree is displayed on the section view. Two things are evident:

- Only one of the blocks was projected onto the section view. Objects in a site can be projected to a section view only if the object falls within the perpendicular swath width at the specified sample line. The block at SL-3 was not projected onto the section view because the block offset value is greater than the perpendicular swath that is encompassed by SL-13. The black, dashed lines in the following image illustrate the sample line extents at SL-13.

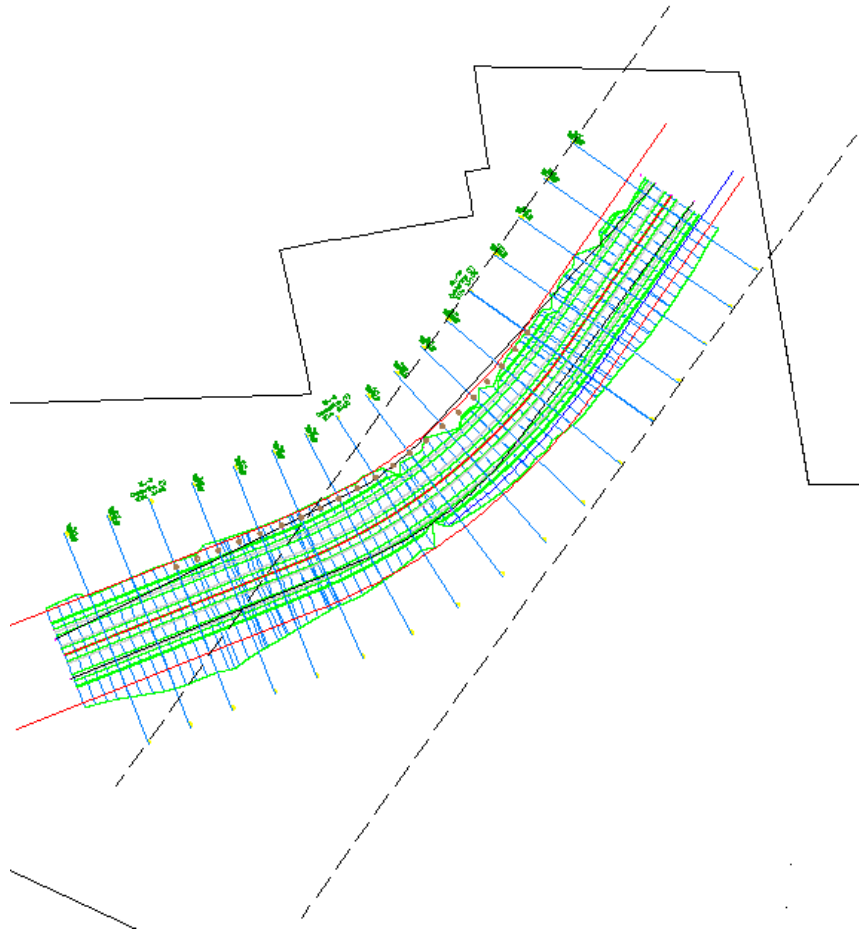

- The block from SL-8 is shown at an elevation that appears to be above the surface. The block is projected at the surface elevation where it is actually located, and not at the surface elevation at the current sample line. However, the offset value that is displayed in the label reflects the object's offset value at the current sample line.

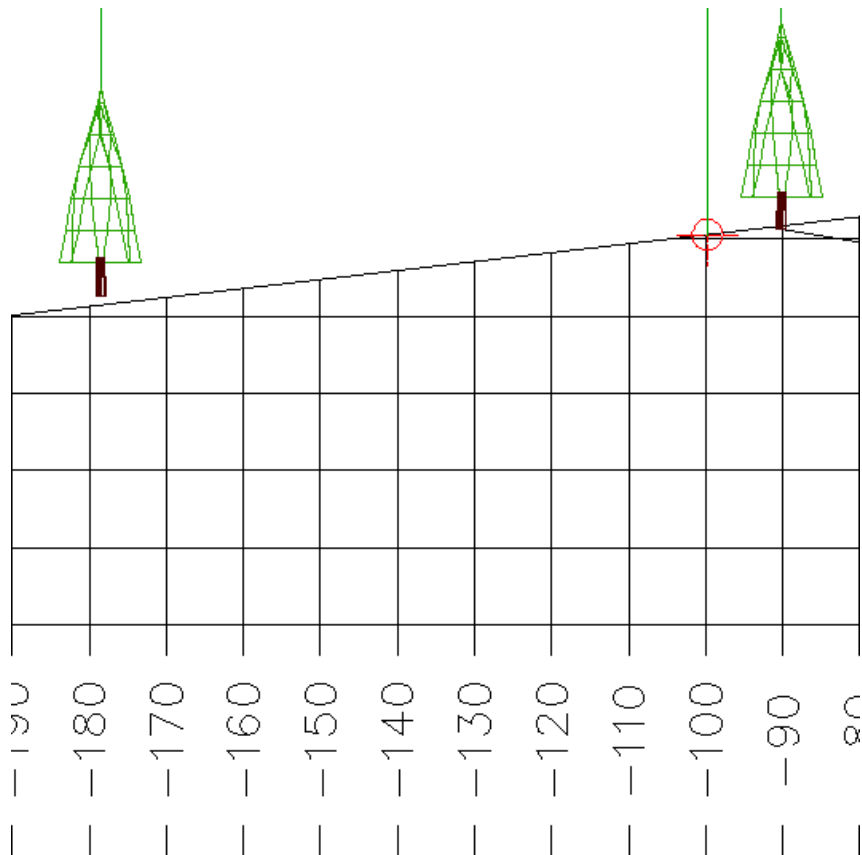

Further exploration: Examine the style settings that are available for projected objects. Projected object styles are located in Toolspace, on the Settings tab, in the General ► Multipurpose Styles ► Projection Styles collection. Label styles for projected objects are located in Toolspace, on the Settings tab, in the Section View ► Label Styles ► Projection collection.

To continue this tutorial, go to [Exercise 2: Adding a Section View Grade Label](#) (page 586).

Exercise 2: Adding a Section View Grade Label

In this exercise, you will create a section view grade label.

For more information, see the AutoCAD Civil 3D Help topic *Sample Line, Section, and Section View Labels*.

This exercise continues from [Exercise 1: Projecting an Object onto a Section View](#) (page 577).

Add a section view grade label

- 1 Open *Sections-Grade-Label.dwg*, which is located in the [tutorial drawings folder](#) (page 819).
- 2 Click Annotate tab ► Labels & Tables panel ► Add Labels menu ► Section View ► Add Section View Labels  .
The Add Labels dialog box is displayed. You will change the existing Grade Label Style to show a grade percentage between two points and the slope length between those points.
- 3 In the Add Labels dialog box, specify the following parameters:
 - Label Type: Grade
 - Grade Label Style: Grade_Slope
- 4 Click Add.
On the command line, you are prompted to select a section view.
- 5 In the drawing, click a grid line of the section view.
On the command line, you are prompted to pick a point.
- 6 In the section view, snap to a low point in the section. Snap to a higher point “up the hill”.
The grade between the two points is displayed. If you wish, add more grade labels to other pairs of points anywhere in the section view.
- 7 Right-click or press Esc to end the labeling session.
- 8 In the Add Labels dialog box, click Close.

To continue this tutorial, go to [Exercise 3: Adding a Data Band to a Section View](#) (page 587).

Exercise 3: Adding a Data Band to a Section View

In this exercise, you will add a data band, which is an optional graphic frame that is associated with the section view.

For more information, see the AutoCAD Civil 3D Help topic *Section View Bands*.

This exercise continues from [Exercise 2: Adding a Section View Grade Label](#) (page 586).

Add a data band to a section view

- 1 Open *Section-Data-Band.dwg*, which is located in the [tutorial drawings folder](#) (page 819).
- 2 Select the section view. Right-click. Click Section View Properties.
- 3 On the Section View Properties dialog box, on the Bands tab, specify the following parameters:
 - Band Type: Section Segment
 - Select Band Style: FG Segments
- 4 Click Add.
- 5 In the List of Bands table, scroll to the right and click the Section 1 cell for the new band that you created. From the drop-down list, select the Corridor (1) Top surface.

NOTE The name of the Corridor (1) Top surface varies depending on the section view that you are editing.

- 6 Click Apply.

A data band is added to the section view in the drawing. Notice that there is no data displayed in the band. This happened because the default Weeding factor specifies that any section segments that are less than 100 drawing units long are not displayed in the band. In the next step, you will reduce the Weeding factor and examine the results.
- 7 In the Section Segment row, change the Weeding value to 5.0000.
- 8 Click OK.

Segment lengths that are greater than 5 drawing units long are annotated in the new data band.

Material Calculation Tutorials

16

These tutorials will get you started working with the AutoCAD Civil 3D tools for calculating and reporting material quantities and volumes.

In the following tutorials, you will learn how to use the material calculation tools:

- *Corridor Earthwork Volume* tools compare an existing and proposed surface at specified alignment stations. An earthwork volume report lists the cumulative cut and fill volumes, as well as the incremental volume at each specified station.
- *Mass Haul Diagrams* display cut and fill volumes along an alignment. Mass haul diagrams illustrate the distance over which cut and fill volumes balance, the volume of material to be moved, and the locations of borrow pits and dump sites.
- *Pay Item Quantities* extract and report the cost of a project based on the quantity of pay items that are assigned to AutoCAD or AutoCAD Civil 3D objects in the project.

NOTE All drawings used in these tutorials are available in the [tutorial drawings folder](#) (page 819). If you want to save your work from these tutorials, save the drawings to the [My Civil Tutorial Data folder](#) (page 819) so that you do not overwrite the original drawings.

For more information, see the AutoCAD Civil 3D Help topic *Material and Quantity Analysis*.

Tutorial: Calculating Earthwork Volumes from Corridor Models

This tutorial demonstrates how to calculate cut and fill earthwork quantities between two surfaces.

Earthwork and material volumes are calculated by comparing two surfaces to each other. You can calculate quantities between sample lines derived from regular surface models and from corridor surfaces.

User-definable tables specify which materials are defined by which surfaces, and the characteristics of these materials. Finally, average end area analysis is used to tabulate the material quantities along the corridor.

For more information, see the AutoCAD Civil 3D Help topic *Analyzing Sectional Volumes*.

Exercise 1: Reviewing Quantity Takeoff Criteria and Report Settings

In this exercise, you will review the options that are available for quantity takeoff criteria and reports.

The quantity takeoff report settings include the default quantity takeoff criteria used to create material lists and default styles for tables. The quantity takeoff criteria includes a list of materials that specifies the surfaces and shapes from which you want to generate volume information.

For more information, see the AutoCAD Civil 3D Help topic *Creating Quantity Takeoff Criteria*.

Review quantity takeoff settings

- 1 Open *Earthworks-1.dwg*, which is located in the [tutorial drawings folder](#) (page 819).
The drawing opens, displaying three viewports.
- 2 In Toolspace, on the Settings tab, expand Quantity Takeoff ► Commands.
- 3 Under the Commands collection, double-click *GenerateQuantitiesReport* to display the Edit Command Settings dialog box.
- 4 Browse through the various settings available, but do not change any settings. When finished, click Cancel.

Examine the quantity takeoff criteria

- 1 In Toolspace, on the Settings tab, expand Quantity Takeoff ► Quantity Takeoff Criteria.
Three styles are defined in the collection.

- 2 Double-click the Earthworks style to open the Quantity Takeoff Criteria dialog box.
- 3 Click the Material List tab.

This tab contains a pre-defined table for calculating earthworks (cut and fill) by comparing a Datum surface layer to an existing ground surface layer.
- 4 Expand the Earthworks item in the table.

You will use the Earthworks criteria in the next exercise to calculate the quantity takeoff.

Notice that the Condition for the EG surface is set to Base, while the condition of the Datum surface is set to Compare. This indicates that the material is going to be fill when Datum is above EG, and cut when Datum is below EG.

Also note the three Factor values in the table:

 - The Cut factor is typically used as an expansion factor for excavated material. It is usually 1.0 or higher.
 - The Fill factor is typically used as a compaction factor for fill material. It is usually 1.0 or higher.
 - The Refill factor indicates what percentage of cut material can be reused as fill. It should be 1.0 or lower.
- 5 Click Cancel.

To continue this tutorial, go to [Exercise 2: Creating a Material List](#) (page 591).

Exercise 2: Creating a Material List

In this exercise, you will create a material list, which defines the quantity takeoff criteria and surfaces to compare during an earthworks analysis.

A material list is required to generate either an earthworks volume report or a mass haul diagram. A material list specifies the existing ground and datum surface to compare, and is saved with the sample line properties.

For more information, see the AutoCAD Civil 3D Help topic *Generating Material Lists*.

This exercise continues from [Exercise 1: Reviewing Quantity Takeoff Criteria and Report Settings](#) (page 590).

Create a material list

- 1 Open *Earthworks-1.dwg*, which is located in the [tutorial drawings folder](#) (page 819).

The drawing opens, displaying three viewports.

- 2 Click Analyze tab ► Volumes And Materials panel ►  Compute Materials.

- 3 In the Select A Sample Line Group dialog box, specify the following parameters:

- Select Alignment: Centerline (1)
- Select Sample Line Group: SLG-1

- 4 Click OK.

The Compute Materials dialog box is displayed, showing a list of all items defined in the selected criteria.

- 5 Verify that the Quantity Takeoff Criteria field is set to Earthworks.

- 6 In the table, expand the Surfaces item.

This shows surfaces EG and Datum. Next, you will set the actual object names that define those surfaces.

- 7 In the Object Name column, in the EG row, click <Click Here...>. Select EG from the list.

- 8 In the Object Name column, in the Datum row, click <Click Here...>. Select Corridor - (1) Datum from the list.

In the Earthworks criteria settings, EG is set as the base surface and Datum is set as the Compare surface. The Object Name fields specify which object calls for both an EG surface as the base and a Datum surface as the comparison. These criteria can be used with multiple projects and corridors.

The Object Name fields in the Compute Materials dialog box define a specific surface and corridor surface to map to the names in the Earthworks criteria.

- 9 Click OK.

The calculation is performed and a list of materials is stored with the sample line group properties. In the drawing, notice that the cut and fill areas in each section are shaded. Hover the cursor over the shaded areas to examine the information that is displayed.

To continue this tutorial, go to [Exercise 3: Generating a Volume Report](#) (page 593).

Exercise 3: Generating a Volume Report

In this exercise, you will use the Earthworks criteria to generate a quantity takeoff report.

For more information, see the AutoCAD Civil 3D Help topic *Analyzing Sectional Volumes*.

This exercise continues from [Exercise 2: Creating a Material List](#) (page 591).

Generate a volume report

- 1 Open *Earthworks-2.dwg*, which is located in the [tutorial drawings folder](#) (page 819).

The drawing opens, displaying three viewports.

- 2 Click Analyze tab ► Volumes And Materials panel ►  Volume Report.

- 3 In the Report Quantities dialog box, specify the following parameters:

- Select Alignment: Centerline (1)
- Select Sample Line Group: SLG-1
- Select A Material List: Material List - (1)
This is the material list you created in [Exercise 2: Creating a Material List](#) (page 591) by calculating volume quantities for the sample line group using the Earthworks criteria.
- Select A Style Sheet: *Earthwork.xml*
- Display XML Report: Selected

- 4 Click OK.

- 5 The report is displayed.

The Cut Volume is the area of material in cut, multiplied by the Cut Factor defined in the quantity takeoff criteria. The Fill Volume is the area of fill material multiplied by the Fill Factor.

The areas for each material are averaged between stations and multiplied by the station difference to produce the incremental volumes. These volumes are added from station to station to produce the cumulative volumes.

Finally, the Cum. Net Volume value at each station is calculated as the cumulative Reusable volume minus the cumulative Fill volume.

To continue to the next tutorial, go to [Working with Mass Haul Diagrams](#) (page 594).

Tutorial: Working with Mass Haul Diagrams

This tutorial demonstrates how to create and edit mass haul diagrams to display earthworks in profile.

Mass haul is defined as the volume of material multiplied by the distance it is moved during construction. A mass haul diagram consists of two objects: a mass haul line, and a mass haul view. The mass haul line represents the free haul and overhaul volumes in cut and fill conditions along an alignment. The mass haul view is the grid on which the mass haul line is drawn.

The middle axis of the mass haul view is known as the balance line. The location of the mass haul line relative to the balance line indicates material movement in the current design. When the mass haul line rises above the balance line, it indicates a region in which material is cut. When the mass haul line falls below the balance line, it indicates a region in which material is fill.

There are two methods to compare free haul volume and overhaul volume:

Grade Points

Grade points are stations at which the proposed project design transitions from cut to fill. In a mass haul diagram, a grade point is the highest or lowest point in a mass haul region. A grade point is the highest point in a mass haul region where the profile transitions from a cut condition to a fill condition. A grade point is the lowest point in a mass haul region where the profile transitions from a fill condition to a cut condition.

In the grade points method of measuring free haul, a horizontal line that is the length of the specified free haul distance is drawn. The line is positioned so that it is both parallel to the balance line and touches the mass haul line. The volume that is enclosed in the area formed by this line and the mass haul line is free haul.

In the following image, the green areas are free haul volume, and the red areas are overhaul volume. The magenta circles and arrows indicate the grade points on the mass haul line and profile. The vertical magenta lines illustrate the

relationship between the mass haul line and profile in the grade point balancing method.

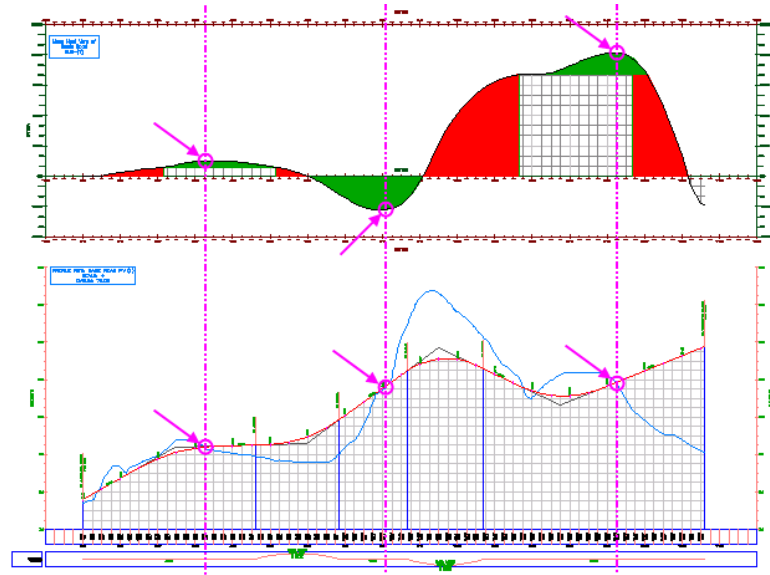

Balance Points

Balance points are the stations at which the net cut and fill volumes are equal. In a mass haul diagram, the balance points are located on the balance line, where the net volume is zero. In the balance points method of measuring free haul, the mass haul line is duplicated and shifted horizontally to the right (where the project transitions from cut to fill) or to the left (where the project transitions from fill to cut) by the free haul distance.

In the following image, the green areas are free haul volume, and the red areas are overhaul. The arrows illustrate the free haul distance in cut and fill conditions.

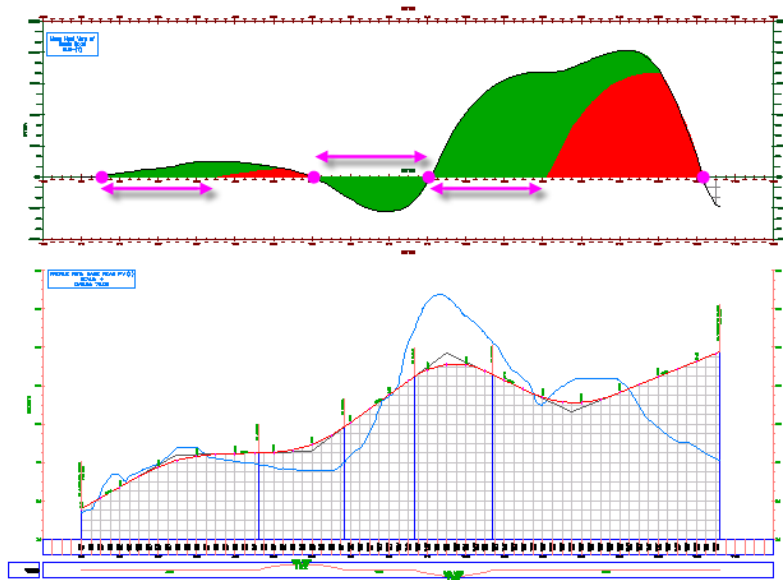

For more information, see the AutoCAD Civil 3D Help topic *Using Mass Haul Diagrams*.

Exercise 1: Creating a Mass Haul Diagram

In this exercise, you will create a mass haul diagram that displays free haul and overhaul volumes for a project site.

To create a mass haul diagram, the following items must be available:

- an alignment
- two surfaces
- a sample line group
- a material list

The sample drawing that you will use for this exercise contains all of these items.

To learn how to create a material list, see the [Creating a Material List](#) (page 591) exercise.

For more information, see the AutoCAD Civil 3D Help topic *Using Mass Haul Diagrams*.

Create a mass haul diagram

- 1 Open *Mass Haul-1.dwg*, which is located in the [tutorial drawings folder](#) (page 819).
- 2 Click Analyze tab ► Volumes And Materials panel ►  Mass Haul.
- 3 In the Create Mass Haul Diagram wizard, on the General page, specify the following parameters:
 - Mass Haul View Name: Mass Haul Balancing
 - Mass Haul View Style: Free Haul and Overhaul
- 4 Click Next.
- 5 On the Mass Haul Display Options page, examine the settings in the Material area. The selection in the Material List is saved with the selected sample line group. To learn how to create a material list, see the [Creating a Material List](#) (page 591) exercise. Examine the options that are available in the Choose A Material To Display As Mass Haul Line list, but accept the default Total Volume option. In the Mass Haul Line area, specify the following settings:
 - Mass Haul Line Name: Mass Haul Line Total Volume
 - Mass Haul Line Style: Free Haul and Overhaul- Grade Point
- 6 Click Next.
- 7 On the Balancing Options page, under Free Haul Options, select the Free Haul Distance check box. Enter 300.0000' as the free haul distance.

This value specifies that the distance that the earthmover hauls material at the standard rate. Material moved beyond this distance is considered overhaul, and typically is charged at a higher rate.
- 8 Click Create Diagram.
- 9 In the drawing, snap to the center of the red circle that is above the profile view to place the mass haul diagram.

The mass haul diagram is displayed, and contains three mass haul regions. As shown in the following image, mass haul regions identify station ranges where material is either cut or fill. When the mass haul line is

above the balance line, material is cut. When the mass haul line is below the balance line, material is fill.

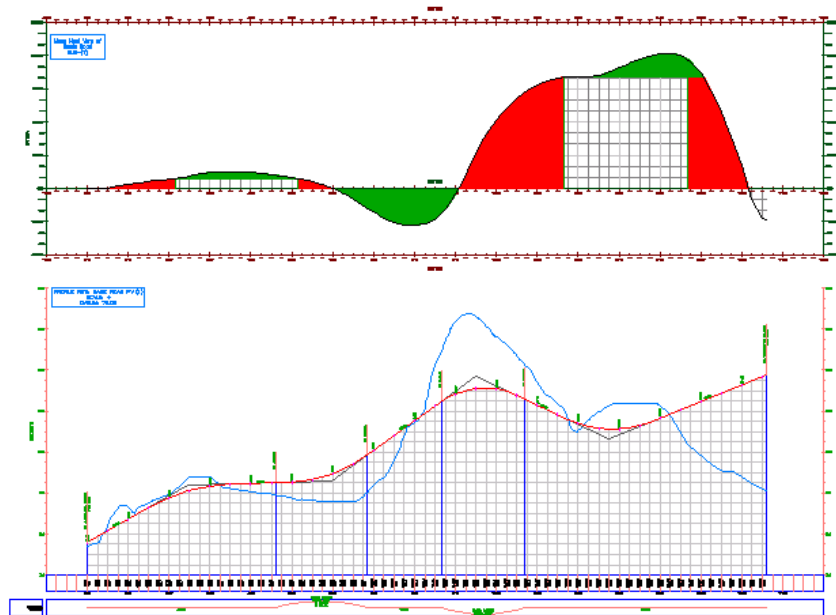

To continue this tutorial, go to [Exercise 2: Balancing Mass Haul Volumes](#) (page 598).

Exercise 2: Balancing Mass Haul Volumes

In this exercise, you will balance the mass haul volumes above and below the balance line, which will eliminate overhaul volume.

For more information, see the AutoCAD Civil 3D Help topic *Using Mass Haul Diagrams*.

This exercise continues from [Exercise 1: Creating a Mass Haul Diagram](#) (page 596).

Balance cut material volumes

NOTE This exercise uses *Mass Haul-1.dwg* with the modifications you made in the previous exercise, or you can open *Mass Haul-2.dwg* from the [tutorial drawings folder](#) (page 819).

- 1 Zoom in on the mass haul region that is on the left-hand side of the diagram.
Notice that the highest point of the green free haul area is at station 3+25. This is the grade point, which is the point at which free haul transitions from cut to fill. Depending on the site conditions, grade points can be logical locations for dump sites or borrow pits, which can reduce or eliminate overhaul.
- 2 At station 3+25, hover the cursor over the mass haul line.
Notice that the tooltip displays the current station number (3+25) and volume (approximately 1500.00 Cu. Yd.).

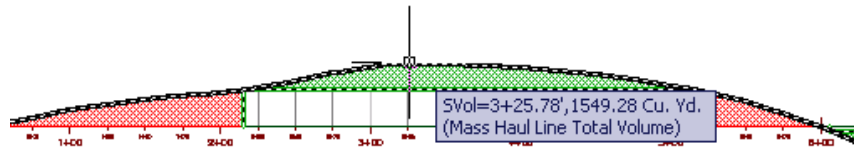

- 3 Select the mass haul line. Right-click. Click Mass Haul Line Properties.
- 4 In the Mass Haul Line Properties dialog box, click the Balancing Options tab.
- 5 In the Add/Remove Borrow Pits And Dump Sites area, click Add Dump Site.
- 6 In the Station cell, enter 325.
This is the number of the station at the grade point for the volume above the balance line.
- 7 In the Capacity cell, enter 1500.
This is the approximate volume (1500.00 Cu.Yd.) at the grade point.
- 8 Click OK.

The cut volume above the balance line is entirely free haul. Notice that now there is a red, overhaul volume below the balance line. You will balance the fill volume in the following procedure.

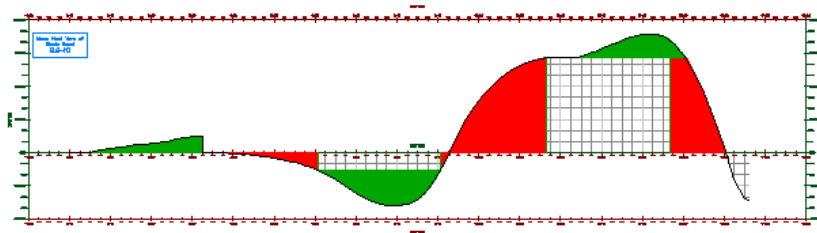

Balance fill material volumes

- 1 Below the balance line, zoom in to station 6+25 on the mass haul line. Notice that this is near the point at which the overhaul volume (in red) and the free haul volume (in green) meet the mass haul line. If you examine this station on the profile, you see that it is also a relatively flat section of the existing ground surface. Flat areas can also be good locations for dump sites and borrow pits.
- 2 At station 6+25, hover the cursor over the mass haul line. Notice that the tooltip displays the current station number and volume, which is approximately 2000.00 Cu. Yd.

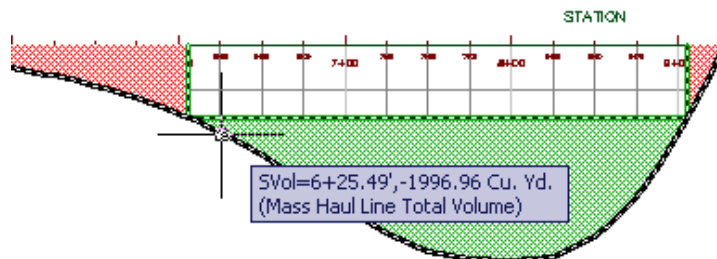

- 3 Select the mass haul line. Right-click. Click Mass Haul Line Properties.
- 4 In the Mass Haul Line Properties dialog box, click the Balancing Options tab.
- 5 In the Add/Remove Borrow Pits And Dump Sites area, click Add Borrow Pit.

- 6 In the Station cell for the borrow pit, click .
- 7 In the drawing, pan to left so that you can see the corridor and surface. Click near station 6+25 on the corridor.
Notice the lack of surface contours in the area around station 6+25. This indicates that the region is relatively flat.
- 8 In the Capacity cell for the borrow pit, enter 2000.
This is the approximate volume value that you noted in Step 2.
- 9 Click OK.
The fill volume below the balance line is entirely free haul.

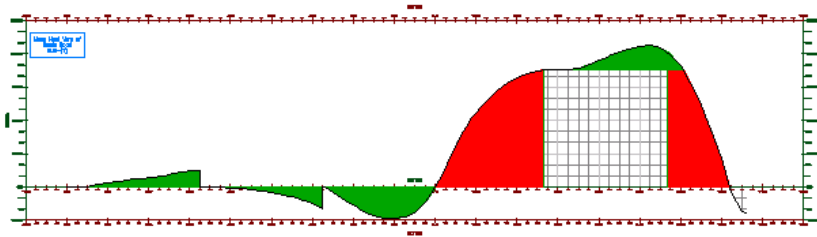

Further exploration: Balance the mass haul volumes in the third region by adding a dump site at station 11+50 with a capacity of 10000 Cu. Yd.

- 10 Close the drawing, but do not save your changes.

To continue this tutorial, go to [Exercise 3: Editing the Mass Haul Line Style](#) (page 601).

Exercise 3: Editing the Mass Haul Line Style

In this exercise, you will create a mass haul line style that is based on an existing style.

The mass haul line style controls the display of the line that displays free haul and overhaul volumes in a mass haul view. The display components, such as color, linetype, and hatch patterns, in the mass haul line style are similar to the components that are in other object styles. The mass haul line style also specifies the method with which free haul is measured.



In this exercise, you will copy an existing mass haul line style to create a new style. You will examine the differences between the grade point and balance point methods of measuring free haul.

NOTE The mass haul view style uses many of the same options as the profile view style. For information about editing the profile view style, see the [Editing the Profile View Style exercise](#) (page 305).

For more information, see the AutoCAD Civil 3D Help topic *Using Mass Haul Diagrams*.

This exercise continues from [Exercise 2: Balancing Mass Haul Volumes](#) (page 598).

To edit the mass haul line style

- 1 Open *Mass Haul-2.dwg*, which is located in the [tutorial drawings folder](#) (page 819).
- 2 In the drawing, select the mass haul line. Right-click. Click Mass Haul Line Properties.
- 3 In the Mass Haul Line Properties dialog box, on the Information tab, in the Object Style area, click the arrow next to . Click  Copy Current Selection.
- 4 In the Mass Haul Line Style dialog box, on the Information tab, change the Name to Free Haul and Overhaul - Balance Point.
- 5 On the Free Haul tab, in the Free Haul Options area, notice that the Measure From Grade Point option is selected. Also notice that the graphic to the right resembles the mass haul diagram in the drawing. Grade points are the points at which volumes transition from cut to fill. When free haul is measured from grade points, the highest point (or lowest, if below the balance line) is the grade point.
- 6 Select Measure From Balance Point.
Notice that the graphic changes. Balance points are the points at which the mass haul line crosses the balance line. These are the station at which the cut volume and fill volume are equal.
- 7 On the Display tab, in the Component Hatch Display area, in the Free Haul Area Hatch row, click the Pattern cell.
- 8 In the Hatch Pattern dialog box, for Pattern Name, select CROSS. Click OK.
- 9 In the Mass Haul Line Style dialog box, click the Display tab. In the Component Hatch Display area, in the Free Haul Area Hatch row, change the Scale to 30.0000.

- Repeat Steps 7 through 9 to change the Overhaul Area Hatch Pattern to DASH.

NOTE A solid component fill provides the best performance. Drawing regeneration may be slower if a hatch pattern is used on a long mass haul diagram.

- Click OK twice.

The patterns you selected are displayed in the free haul and overhaul areas of the mass haul diagram. Notice that the mass haul diagram uses the balance point method to measure free haul.

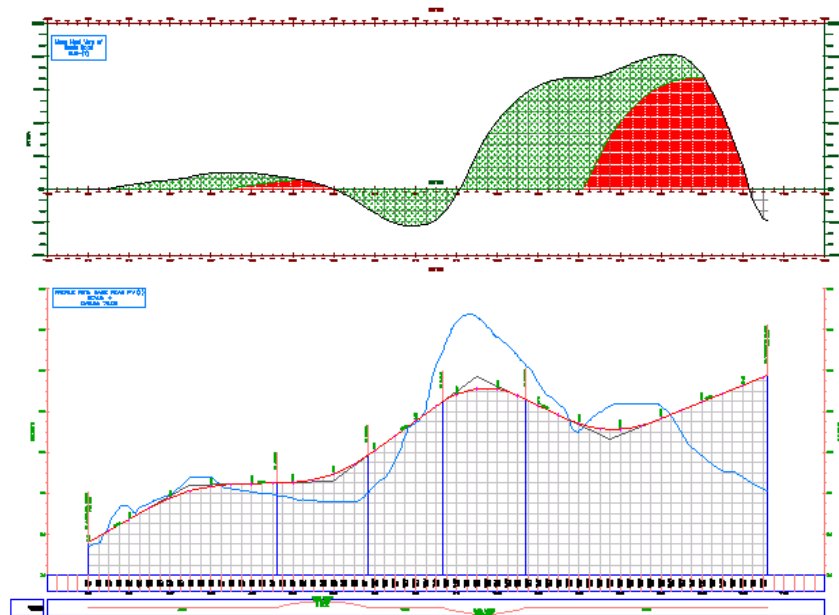

To continue to the next tutorial, go to [Calculating and Reporting Quantities](#) (page 603).

Tutorial: Calculating and Reporting Quantities

In this tutorial, you will learn how to create and manage pay item data, associate pay item codes with several types of drawing objects, and generate pay item quantity reports.

A *pay item* is a specific unit of work for which a price is provided and paid to a contractor while a site is under construction. It consists of a pay item ID number, description, and unit of measure.

Pay items can be associated with any AutoCAD entity, such as lines, closed polygons, and blocks, after they have been created. When pay items are associated with an AutoCAD Civil 3D pipe network parts list or code set style, then the pipe network or corridor object is automatically tagged with the specified pay items.

For more information, see the AutoCAD Civil 3D Help topic *Using Pay Items to Analyze Quantities*.

Exercise 1: Loading and Navigating a Pay Item List

In this exercise, you will open a sample file that contains a pay item list and examine the contents.



A *pay item file* contains a listing of the pay item codes, descriptions, and units of measure.

An optional *pay item categorization file* categorizes the pay items into manageable groups. A pay item categorization file groups similar pay items by common pay item code prefixes.

You will learn how to create a custom pay item file and categorization file in [Exercise 7: Creating a Pay Item List](#) (page 625).

For more information, see the AutoCAD Civil 3D Help topics *Importing Master Pay Item Lists* and *Managing Pay Item Lists*.

Load a pay item file

- 1 Open *Quantities-1.dwg*, which is located in the [tutorial drawings folder](#) (page 819).
This drawing contains a commercial site, which consists of a building footprint, a parking lot, and access roads.
- 2 Click Analyze tab ► QTO panel ►  QTO Manager.
- 3 In the QTO Manager vista, click  Open Pay Item File.
- 4 In the Open Pay Item File dialog box, specify the following parameters:

NOTE The Pay Item File and Pay Item Categorization File are located in the [Data\Pay Item Data\Getting Started folder](#) (page 819).

- Pay Item File Format: CSV (Comma Delimited)
- Pay Item File: Getting Started.csv
- Pay Item Categorization File: Getting Started Categories.xml

5 Click OK.

The pay item categories are displayed in the QTO Manager vista. The Pay Item ID column lists the categories that are specified in the pay item categorization file. The Description column identifies the contents of each category.

Search for pay items

1 In the Pay Item ID column, expand several Pay Item ID categories.

Notice that any material or unit of work can be classified as a pay item. The Unit Type column identifies the unit of measure assigned to each pay item.

2 Click  Turn Off Categorization.

The categories specified by the pay item categorization file are removed. The QTO Manager displays all pay items in the pay item file.

3 In the Enter Text To Filter Pay Items field, enter Asphalt. Click .

The filtered pay item list displays only pay items that have a description that contains the word “asphalt”.

4 In the Enter Text To Filter Pay Items field, enter 60902-0800. Click .

A single pay item is displayed. This method of filtering searches in both the pay item ID and description, and is helpful if you know the pay item number.

5 In the Pay Item ID column, right-click the pay item number. Click Add To Favorites List.

6 Expand the Favorites collection.

The specified pay item is displayed in the Favorites list, which is a convenient location to save frequently used pay items.

NOTE The contents of the Favorites category are saved with the drawing. To save time during this tutorial, the pay items you will use are saved as Favorites in subsequent drawings.

To continue this tutorial, go to [Exercise 2: Assigning Pay Item Codes to AutoCAD Objects](#) (page 606).

Exercise 2: Assigning Pay Item Codes to AutoCAD Objects

In this exercise, you will assign pay item codes to a variety of AutoCAD objects, including lines, blocks, and closed polyline areas.

You will use the AutoCAD Quick Select and Select Similar commands to select similar objects. You can use these commands to assign a pay item code to many objects at the same time.

For more information, see the AutoCAD Civil 3D Help topic *Tagging Objects with Pay Items*.

This exercise continues from [Exercise 1: Loading and Navigating a Pay Item List](#) (page 604).



Assign a pay item code to linear objects

- 1 Open *Quantities-2.dwg*, which is located in the [tutorial drawings folder](#) (page 819).
This drawing contains a commercial site, which consists of a building footprint, a parking lot, and access roads.
- 2 On the command line, enter QSELECT.
- 3 Click OK to acknowledge that objects were not selected.
- 4 In the Quick Select dialog box, specify the following parameters:
 - Apply To: Entire Drawing
 - Object Type: Line
 - Properties: Layer
 - Operator: = Equals
 - Value: PKNG-STRP-AISLES

- How To Apply: Include In New Selection Set
 - Append to Current Selection Set: Selected
- 5 Click OK.
 - 6 Press Enter to return to the Quick Select dialog box.
 - 7 Repeat Steps 2 through 4 to select the lines on the PKNG-STRP-STALLS layer.

In the drawing, all parking lot stall lines are selected.



- 8 Click Analyze tab ► QTO panel ►  QTO Manager.
- 9 In the QTO Manager vista, click .

TIP You can also right-click the pay item and click Assign Pay Item.

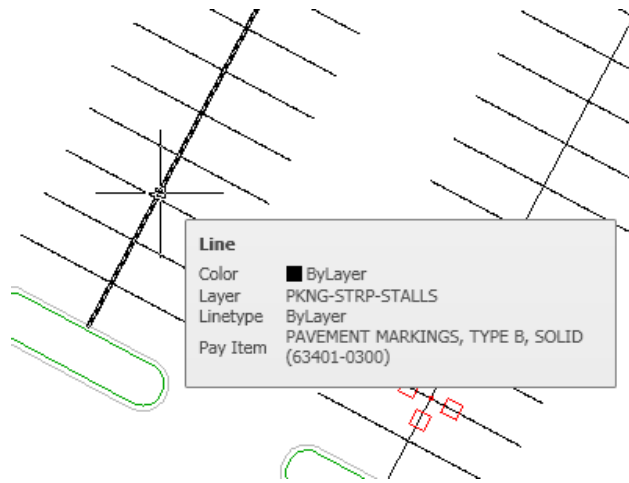

- 10 In the  Favorites category, select Pay Item ID 63401-0300.
- 11 Press Enter.
- 12 Hover the cursor over one of the parking lot lines.
The tooltip displays the pay item description and ID that has been assigned to that object.



Assign a pay item to AutoCAD blocks

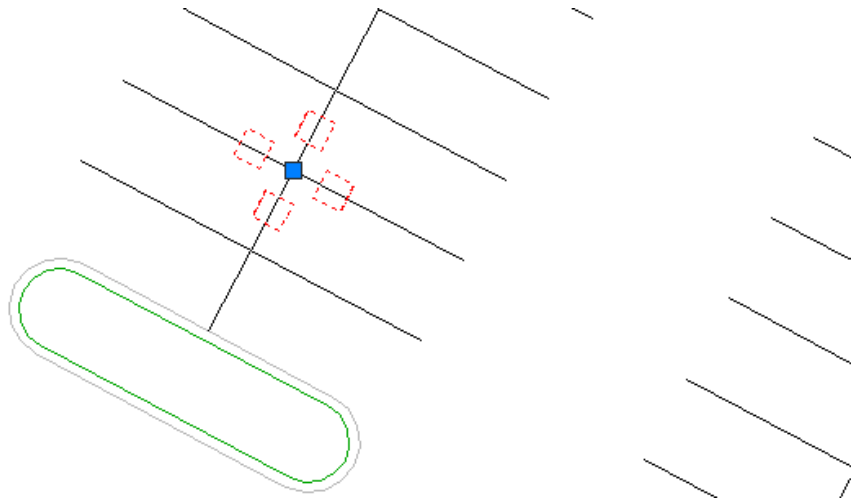

- 1 In the drawing, select one of the blocks that represent parking lot lamps.

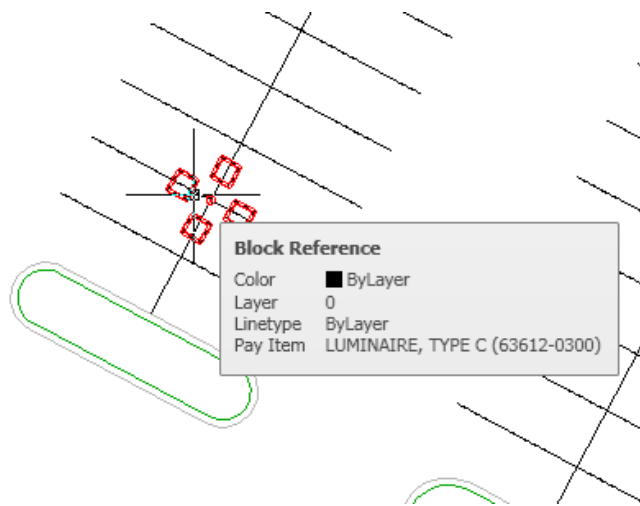

- 2 Right-click. Click Select Similar.
All the lamp blocks are selected.
- 3 Click .
- 4 In the  Favorites category, select Pay Item ID 63612-0300.
- 5 Press Enter.
- 6 Hover the cursor over one of the blocks.
The tooltip displays the description and ID of each pay item that has been assigned to that block.



Assign multiple pay item codes to a closed area

- 1 In the QTO Manager vista, click .
- 2 In the  Favorites category, select the following pay items:
 - 62401-0400
 - 62511-2000
 - 62525-0000

TIP To select multiple items, hold the Ctrl key down and then click the items.

- 3 Press Enter.
- 4 On the command line, enter O.
 This action activates object selection mode, in which you select the outline of a closed object, as opposed to a point inside the object. Because some of the parking lot islands are subdivided by pipes, you can use object selection mode to assign the pay item codes to the entire object, not only to the closed area that you select.

TIP For faster performance, zoom in to a closed polygon before you select it.

- 5 In the drawing, click the green border in a parking lot island.
A solid hatch pattern is displayed in the parking lot island. This indicates that the pay items have been applied to the area.
- 6 Select several other islands.

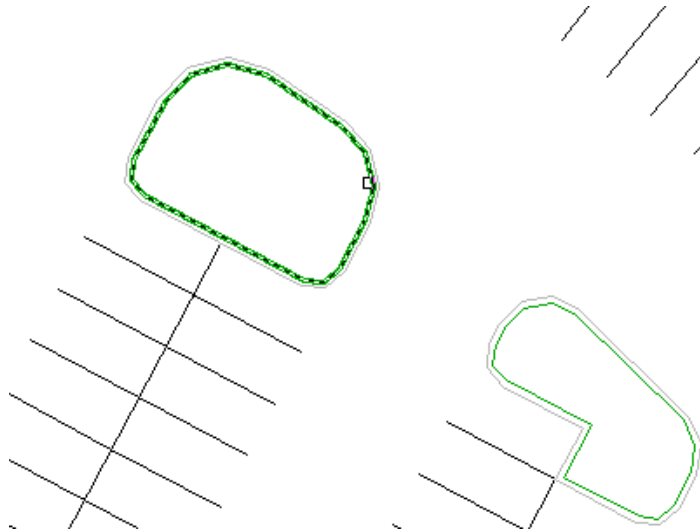

- 7 Press Enter to end the command.
- 8 Hover the cursor over one of the parking lot islands.
The tooltip displays the description and ID of each pay item that has been assigned to that area.

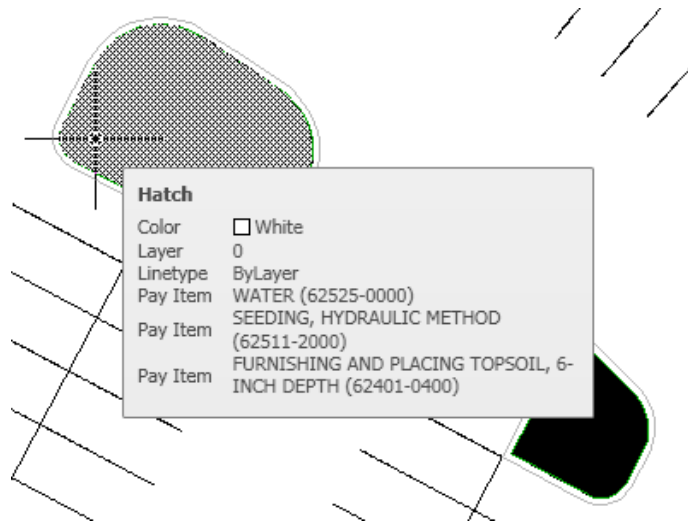

To continue this tutorial, go to [Exercise 3: Assigning Pay Item Codes to Pipe Network Parts](#) (page 612).

Exercise 3: Assigning Pay Item Codes to Pipe Network Parts

In this exercise, you will modify a parts list to assign pay item codes to pipe network parts as they are created. You will also learn how to assign pay item codes to existing pipe network parts.



For more information, see the AutoCAD Civil 3D Help topic *Tagging Objects with Pay Items*.

This exercise continues from [Exercise 2: Assigning Pay Item Codes to AutoCAD Objects](#) (page 606).

Specify the QTO command settings





- 1 Open *Quantities-3.dwg*, which is located in the [tutorial drawings folder](#) (page 819).

This drawing contains a commercial site, which consists of a building footprint, a parking lot, and access roads. The site also contains a storm sewer network that has pipes and several types of structures.

- 2 Click Analyze tab ► QTO panel ►  QTO Manager.
- 3 In the QTO Manager vista, click .
- 4 In the Quantity Takeoff Command Settings dialog box, under Compute Takeoff Options, specify the following parameters:
 - Length Computation Type: 3D
 - Pipe Length Type: To Inside Edges

These parameters specify that the pipe lengths will be reported, using the end-to-end distance, from the inside edge of each structure.
- 5 Click OK.



Add pay item codes to a pipe network

- 1 In the drawing, select a pipe network part. Click Pipe Networks tab ► Modify panel ►  Network Properties.
- 2 In the Pipe Network Properties dialog box, on the Layout Settings tab, under Network Parts List, click  Edit Current Selection.
- 3 In the Network Parts List dialog box, on the Pipes tab, expand the Storm Sewer ► Concrete Pipe category.
- 4 In the 18 inch RCP row, click .
- 5 In the Pay Item List dialog box, expand the  Favorites category.
- 6 In the  Favorites category, select Pay Item ID 60201-0600.
- 7 Click OK.
- 8 Click the Structures tab.
- 9 Repeat Steps 4 through 7 to assign pay items to the following structures:

Structure	Pay Item ID
51 x 6 x 51 inch Concrete Rectangular Headwall Mat_CONC	60103-0100
Eccentric Structure 48 dia 24 frame 24 cone 5 wall 6 floor Mat_CONC	60403-1100 60409-0500

10 Click OK three times.

Add parts with pay items to the pipe network

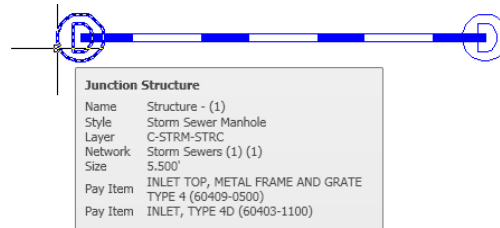

- 1 In the drawing, select a pipe. Click Pipe Networks tab ► Modify panel ►  Edit Pipe Network.
- 2 On the Network Layout Tools toolbar, specify the following parameters:
 - Structure: Eccentric Structure 48 dia 24 frame 24 cone 5 wall 6 floor Mat_CONC
 - Pipe: 18 inch RCP
 -  Pipes and Structures: Selected
- 3 In the drawing, click two points.
This action creates two structures that are connected by a pipe.
- 4 Press Enter.
- 5 Hover the cursor over one of the new structures.
The tooltip displays the description and ID of each pay item that has been assigned to that structure.

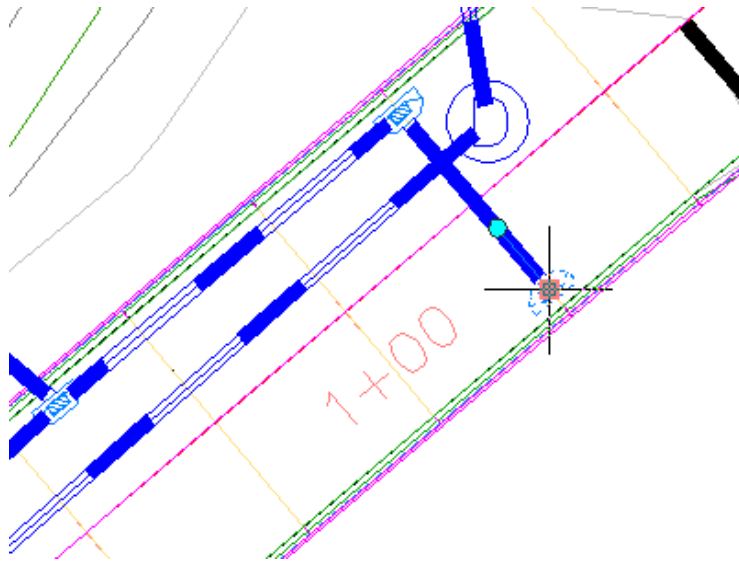

Assign pay items to existing pipe network parts

- 1 In the drawing, select one of the catch basins along the road.



- 2 Right-click. Click Select Similar.
- 3 In the QTO Manager vista, click .
- 4 In the  Favorites category, select Pay Item IDs 60403-1100 and 60409-0500.
- 5 Press Enter.
- 6 Hover the cursor over one of the catch basins.
The tooltip displays the description and ID of the pay items that have been assigned to the catch basin.

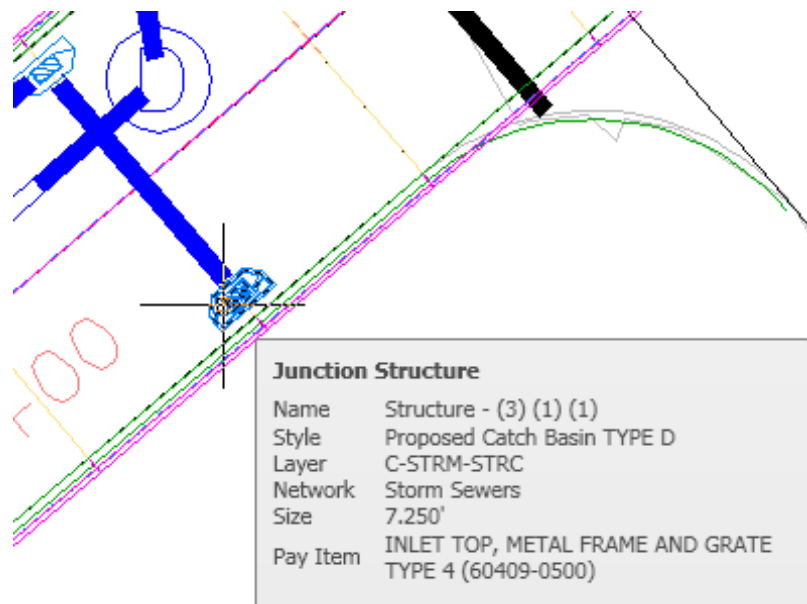

Further exploration: Repeat this procedure on the other structures in the network, assigning pay item codes that are appropriate for the square catch basins, manholes, and headwalls.

To continue this tutorial, go to [Exercise 4: Assigning Pay Item Codes to Corridors](#) (page 616).

Exercise 4: Assigning Pay Item Codes to Corridors

In this exercise, you will create a code set style to assign pay item codes to corridor areas and linear features.

A code set style applies pay items to the link or point codes that define corridor assemblies. The code set style enables you to use the corridor model to compute quantities for a variety of units of measure, such as:

- **Cumulative Area or Volumes:** To extract cumulative volumes of closed corridor areas, apply pay item codes to corridor links. Links with pay item codes are used to extract pay item area or volumetric quantities of materials such as asphalt, gravel, or soil.
- **Linear Quantities:** To extract linear quantities along a corridor feature line, apply pay item codes to corridor points.

Points with pay item codes are used to extract linear quantities for materials such as guardrails and curb.



- **Itemized Count:** To extract itemized quantities of a particular item, apply pay item codes to corridor points, and use a formula to compute the quantity from the feature line length.

NOTE You will learn how to create and apply pay item formulas in [Exercise 6: Working with Pay Item Formulas](#) (page 622).

For more information, see the AutoCAD Civil 3D Help topic *Tagging Objects with Pay Items*.

This exercise continues from [Exercise 3: Assigning Pay Item Codes to Pipe Network Parts](#) (page 612).

Create a code set style

- 1 Open *Quantities-4.dwg*, which is located in the [tutorial drawings folder](#) (page 819).
This drawing contains a commercial site, which consists of a building footprint, a parking lot, and access roads.
- 2 In Toolspace, on the Settings tab, expand the General ► Multipurpose Styles ► Code Set Styles collection. Right-click All Codes. Click Copy.
- 3 In the Code Set Style dialog box, on the Information tab, for Name, enter Corridor Quantities.
- 4 On the Codes tab, under Link, in the Base row, click .
- 5 In the  Favorites category, select Pay Item ID 30202-0600.
- 6 Click OK.
- 7 Repeat Steps 4 through 6 to apply pay item codes to the following links:
 - Pave: 40920-1000
 - Pave1: 40930-0200
 - Pave2: 40310-3300
 - SubBase: 30202-0800
- 8 Repeat Steps 4 through 6 to apply pay item codes to the following Point:

Top_Curb: 60902-0800

- 9 Click OK.

Apply the new code set to the corridor and assembly

- 1 In the drawing, select the side road corridor. Right-click. Click Properties.

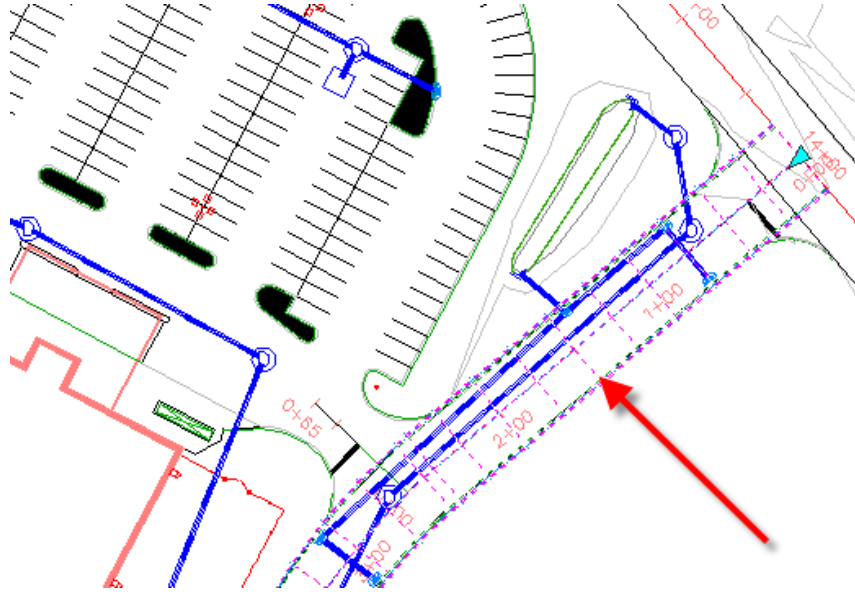

- 2 On the Properties palette, under Data, for Code Set Style Name, select Corridor Quantities.
- 3 Press Esc.
- 4 In the drawing, select the baseline of the corridor assembly. Right-click. Click Properties.
- 5 On the Properties palette, under Data, for Code Set Style Name, select Corridor Quantities.
- 6 Press Esc.
- 7 Rebuild the corridor.

To continue this tutorial, go to [Exercise 5: Working with Quantity Reports](#) (page 619).

Exercise 5: Working with Quantity Reports

In this exercise, you will generate quantity reports, and then examine several ways to use the resulting data.

You can display and save reports in multiple formats, including XML, CSV, HTML, and TXT. Two types of quantity takeoff reports are available:

- **Summary Report:** Lists the total sum of each pay item. You can restrict a summary report to compute pay item quantities relative to the station range of a specified alignment.
- **Detailed Report:** Lists the quantity of each pay item type (area, count, and linear). Each instance of a pay item is reported as a separate line item, and its position relative to a specified alignment may be reported. You can restrict an itemized report to compute pay items relative to the station range of a specified alignment.

For more information, see the AutoCAD Civil 3D Help topic *Reporting Pay Item Quantities*.

This exercise continues from [Exercise 4: Assigning Pay Item Codes to Corridors](#) (page 616).

Generate a summary pay item quantity report

- 1 Open *Quantities-5.dwg*, which is located in the [tutorial drawings folder](#) (page 819).
This drawing contains a commercial site, which consists of a building footprint, a parking lot, and access roads. Several of the objects in this drawing have pay items associated with them.
- 2 Click Analyze tab ► QTO panel ►  Takeoff.
- 3 In the Compute Quantity Takeoff dialog box, specify the following parameters:
 - Report Type: Summary
 - Report Extents: Drawing
This option specifies that the report will include pay item data for all objects in the current drawing. Other options enable you to restrict the report to objects that are within a sheet or selection set.
 - Limit Extents To Alignment Station Range: Cleared
Use this option to specify an alignment station range to which to restrict the report. The report will include pay item data for drawing

objects that can be projected onto the alignment within the specified station range.

In this exercise, you will not restrict the quantity report.

- Report Selected Pay Items Only: Cleared
- 4 Click Compute.
 - 5 In the Quantity Takeoff Report dialog box, in the drop-down menu, select Summary (TXT).xsl.
Examine the report. Notice that the report lists the ID, description, total quantity, and unit of measure for each pay item.

NOTE The quantities for the pay items that are associated with the corridor codes are not calculated in a summary report. In the following steps, these items will be calculated in a itemized report.

 - 6 In the Quantity Takeoff Report dialog box, click Close.

Generate a detailed pay item quantity report

- 1 In the Compute Quantity Takeoff dialog box, specify the following parameters:
 - Report Type: Detailed
 - Report Extents: Selection Set
 - Limit Extents To Alignment Station Range: Cleared
 - Report Selected Pay Items Only: Cleared
 - Report Station And Offset Relative To: Side Road
In a detailed report, the station and offset value for each item relative to a specified alignment is displayed.
- 2 Next to Report Extents, click .
- 3 In the drawing, select the pipes and structures along the side road. Press Enter.

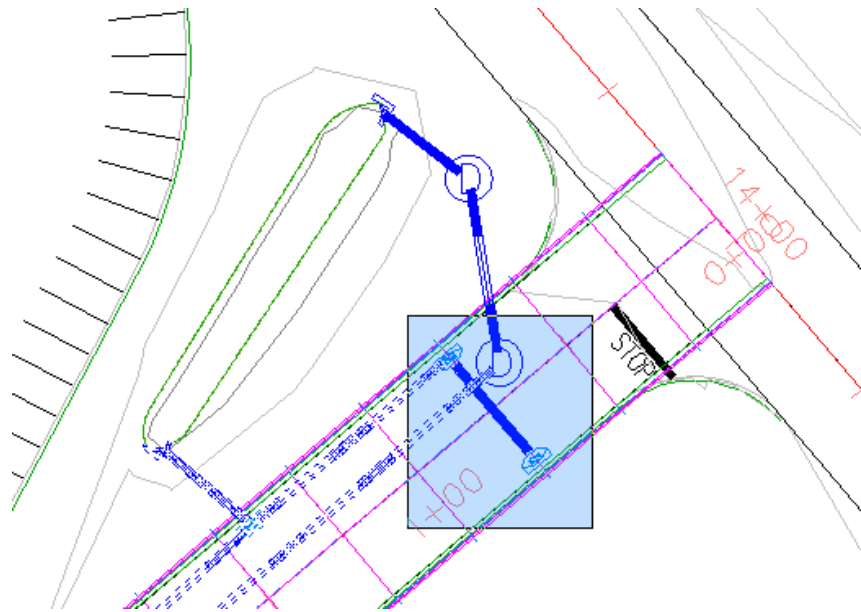

- 4 Click Compute.
- 5 In the Quantity Takeoff Report dialog box, in the drop-down menu, select Detailed Linear (HTML).xsl.
Examine the report. The length, station, and offset of the start and end of each pipe is displayed in this report.
- 6 In the drop-down menu, select Detailed Count (HTML).xsl.
The baseline, station value, and offset of the object to which each pay item is assigned is displayed for each pay item instance.
Notice that several instances of Pay Item 60409-0500 are 17 feet on either side of the alignment. This indicates that these inlets are placed along the edges of pavement of the Side Road corridor.

Insert a quantity takeoff report into the drawing

- 1 Click Draw.
- 2 Pan to an empty space in the drawing.
- 3 Click the place the table.
The drawing zooms to the quantity takeoff report, which is in an AutoCAD table.

Export a quantity takeoff report

- 1 In the Quantity Takeoff Report dialog box, in the drop-down menu, select Detailed Area (CSV).xsl.
You can export a quantity takeoff report to any of the formats in this list.
- 2 Click Save As.
- 3 In the Save Quantity Takeoff Report As dialog box, navigate to the [My Civil Tutorial Data folder](#) (page 819).
- 4 For File Name, enter *QTO_Detailed Area (CSV).txt*. Click Save.
You can import the text file into a spreadsheet application, such as Microsoft Excel.
- 5 Click Close twice.

To continue this tutorial, go to [Exercise 6: Working with Pay Item Formulas](#) (page 622).

Exercise 6: Working with Pay Item Formulas

In this exercise, you will build a mathematical formula that applies a pay item to a corridor at a specified interval.

In the example used in this exercise, the pay item formula adds recessed pavement markers at 10-foot intervals along the corridor. Similar applications of this formula include lane striping and quantity of posts along a guardrail or fence.

Formulas can also be used to convert pay item quantities from one unit of measure to another. For example, you could create a formula that converts square yards of a given pay item to tonnage.

Pay item formulas, label expressions, and design checks are created in a similar manner. However, unlike label expressions and design checks, pay item formulas are not saved in the current drawing. You will learn how to save and manage pay item formula files in this exercise.





For more information, see the AutoCAD Civil 3D Help topic *Using Formulas with Pay Item Lists*.

This exercise continues from [Exercise 5: Working with Quantity Reports](#) (page 619).



Create a pay item formula

- 1 Open *Quantities-6.dwg*, which is located in the [tutorial drawings folder](#) (page 819).

This drawing contains a commercial site, which consists of a building footprint, a parking lot, and access roads.

- 2 In the drawing, select the side road corridor. Click Corridor tab ► Modify panel ► Corridor Properties drop-down ►  Corridor Properties.
- 3 In the Corridor Properties dialog box, on the Feature Lines tab, in the Crown row, click .
- 4 In the Pay Item List dialog box, expand the  Favorites category.
- 5 In the  Favorites category, select Pay Item ID 63407-0000.
- 6 In the Pay Item ID number 63407-0000 row, click the Formula cell.
You are notified that pay item formulas must be written to an external file. After the formula file has been saved, it remains associated with the current drawing. Other formulas that you write in the current drawing will be saved to the same formula file.
- 7 Click OK.
- 8 In the Specify A Quantity Takeoff Formula File dialog box, navigate to the [My Civil Tutorial Data folder](#) (page 819).

BEST PRACTICE Save the pay item formula file in the same location as either the drawing with which it is used, or the master pay item list. If you send the drawing to another user, you must also send the formula file.

- 9 For File Name, enter *Tutorial_QTO_Pay-Item-Formulas.for*. Click Save.
- 10 In the Pay Item Formula dialog box, click . Click TRUNC.
- 11 Click . Click Item Length.
- 12 Using either your keyboard or the buttons on the QTO Pay Item Formula dialog box, enter $/10)+1$ in the Expression field.
When you are finished, the formula in the Expression field should look like this:

$\text{TRUNC}(\{\text{Item Length}\}/10)+1$



This formula truncates the feature line length to an integer value, and then divides it by ten. The resulting value is used as the pay item count for the recessed pavement marker. If there is a remainder from dividing the feature line length by ten, then one recessed pavement marker is added to the sum.

- 13 Click OK.

In the Pay Item List dialog box, in the Pay Item ID number 63407-0000 row, a  is displayed in the Formula cell. This indicates that a formula has been added to this pay item.

- 14 Click OK twice.

Generate a detailed quantity takeoff report

- 1 Click Analyze tab ► QTO panel ► QTO Manager .
- 2 In the QTO Manager vista, in the Favorites category, select the Pay Item ID 63407-0000 row.
- 3 Click Analyze tab ► QTO panel ►  Takeoff.
- 4 In the Compute Quantity Takeoff dialog box, specify the following parameters:
 - Report Type: Detailed
 - Report Extents: Drawing
 - Limit Extents to Alignment Station Range: Selected
 - Alignment: Side Road
 - Report Selected Pay Items Only: Selected
 - Report Station And Offset Relative To: Side Road
- 5 Click Compute.
- 6 In the Quantity Takeoff Report dialog box, in the drop-down menu, select Detailed Count (HTML).xsl
Scroll through the report and examine the Recessed Pavement Marker pay items. The alignment is 1090 feet long. The formula you created divided the alignment length by ten, which resulted in the quantity of 110.

- 7 Click Close twice.

Load a different formula file

- 1 Click Analyze tab ► QTO panel ►  QTO Manager.
- 2 In the QTO Manager vista, click Open ► Formula File.
Use the Open dialog box to navigate to an existing pay item formula file. You can have several formula files available, and switch between them as needed.
- 3 Click Cancel.

To continue this tutorial, go to [Exercise 7: Creating a Pay Item List](#) (page 625).

Exercise 7: Creating a Pay Item List

In this exercise, you will add content to a sample pay item list, update the categorization file, and then examine the results.

You can use this workflow to create custom pay item lists and categorization files from existing data.

This exercise continues from [Exercise 6: Working with Pay Item Formulas](#) (page 622).

Create a new pay item list

- 1 Open *Quantities-7.dwg*, which is located in the [tutorial drawings folder](#) (page 819).
This drawing contains a commercial site, which consists of a building footprint, a parking lot, and access roads.
- 2 Click Analyze tab ► QTO panel ►  QTO Manager.
- 3 In Windows Explorer, navigate to the [Data\Pay Item Data\Getting Started folder](#) (page 819).
- 4 Select *Getting Started.csv*. Right-click. Click Open With ► Microsoft Office Excel.
The pay item list opens in Microsoft Excel. Notice that the Pay Item, Item Description, and Unit_E columns correspond to the Pay Item ID, Description, and Unit Type columns in the QTO Manager vista. You can

use this structure to create a custom pay item list, and then save it as a CSV file.

- 5 In Microsoft Excel, select row 2. Right-click. Click Insert.
- 6 Repeat Step 5 four times to create five empty rows.
- 7 Enter the following information in the new rows:

Pay Item	Item Description	Unit
14101-0025	SIGN, SPEED LIMIT, 25	EACH
14101-0030	SIGN, SPEED LIMIT, 30	EACH
14102-0011	SIGN, RIGHT TURN ONLY	EACH
14102-0012	SIGN, RIGHT TURN OR STRAIGHT	EACH
14102-0020	SIGN, LEFT TURN ONLY	EACH

- 8 Save the pay item list in the [My Civil Tutorial Data folder](#) (page 819). Name the pay item file *Tutorial_QTO_Pay-Items.csv*.

Update the pay item categorization file

- 1 In the QTO Manager vista, expand the Division 150 ► Group 151 category.
- 2 In Windows Explorer, navigate to the [Data\Pay Item Data\Getting Started folder](#) (page 819).
- 3 Select *Getting Started Categories.xml*. Right-click. Click Open With ► Notepad.

TIP You can use any XML editor to modify the pay item categorization file.

The categorization file opens in Notepad.

- 4 In Notepad, select the following lines:

```
<category type="value" start="" end="" title="Division 150" description="Project Requirements">
  <category type="value" start="" end="" title="Group 151" description="Mobilization">
    <category type="value" start="15101" end="" title="Section 15101" description="Mobilization"/>
```

</category>

Compare this content to the categories displayed in the QTO Manager vista. The Start values specify the pay items that are in each category. For example, pay items that start with 15101 are included in the Section 15101 category.

You will use this structure as a basis to create a new set of categories.

- 5 Right-click the highlighted lines. Click Copy.
- 6 Place the cursor at the beginning of the block you copied in the previous step. Press Enter.
- 7 Place the cursor in the empty row. Right-click. Click Paste.
- 8 In the block that you copied, copy the following line:

```
<category type="value" start="15101" end="" title="Section 15101" description="Mobilization"/>
```
- 9 Place the cursor at the end of the line that you copied in the previous step. Press Enter.
- 10 Right-click. Click Paste.
- 11 In the lines you pasted, replace the existing values with the following values:

Start	End	Title	Description
		Division 140	Traffic Control
		Group 141	Signs
14101		Section 14101	Speed Limit
14102		Section 14102	Traffic Direction

- 12 Select the </category> line at the end of the new block. Right-click. Click Copy.
- 13 Place the cursor at the end of the line you copied in the previous step. Press Enter.
- 14 Right-click. Click Paste.

When you are finished, the new code should look like this:

```
<category type="value" start="" end="" title="Division 140" description="Traffic Control">
```

```
<category type="value" start="" end="" title="Group 141" description="Signs">
  <category type="value" start="14101" end="" title="Section 14101" description="Speed Limit"/>
  <category type="value" start="14102" end="" title="Section 14102" description="Traffic Direction"/>
</category>
</category>
```

- 15 Save the pay item list in the [My Civil Tutorial Data folder](#) (page 819). Name the pay item file *Tutorial_QTO_Pay-Item_Categorization.xml*.

Load the updated files into a drawing

- 1 In the QTO Manager vista, click  Open Pay Item File.
- 2 In the Open Pay Item File dialog box, specify the following parameters:

NOTE The Pay Item File and Pay Item Categorization File are located in the [My Civil Tutorial Data folder](#) (page 819).

- Pay Item File Format: CSV (Comma Delimited)
 - Pay Item File: *Tutorial_QTO_Pay-Items.csv*
 - Pay Item Categorization File: *Tutorial_QTO_Pay-Item_Categorization.csv*
- 3 Click OK.
 - 4 In the QTO Manager vista, expand the Division 140 ► Group 141 ► Section 14101 and Section 14102 categories.
Notice that the new pay items and categories are present.

Pipe Network Tutorials

17

These tutorials will get you started working with the pipe networks features, which you use to design and model the flow and function of a utility system, such as a storm or sanitary sewer.

NOTE If you have not installed AutoCAD Civil 3D to the default location, you may receive messages in the Event Viewer indicating that pipe network part catalogs are not found. To avoid these messages, it is recommended that you follow the exercises in the order presented. Alternatively, you can reset the path to the catalogs by clicking Home tab ► Create Design panel ▼ Set Pipe Network Catalog  .

NOTE All drawings used in these tutorials are available in the [tutorial drawings folder](#) (page 819). If you want to save your work from these tutorials, save the drawings to the [My Civil Tutorial Data folder](#) (page 819) so that you do not overwrite the original drawings.

For more information, see the AutoCAD Civil 3D Help topic *Pipe Networks*.

Tutorial: Creating a Pipe Network

This tutorial demonstrates how to create a pipe network using the specialized layout tools.

You create a pipe network by selecting start and end points for pipes and locations for structures. You can connect pipes to a structure or to another pipe. The types of pipes and structures you can create in the pipe network are specified by a parts list. A parts list is a subset of the entire pipe network part catalog.

When you create a pipe network, you can associate it with a default surface and alignment. The placement and sizing of parts is adjusted as you lay out your pipe network using the surface data and the design rules for your pipe network. The alignment is primarily a reference for pipe network labeling.

For more information, see the AutoCAD Civil 3D Help topic *Creating Pipe Networks*.

Exercise 1: Creating a Pipe Network from a Polyline

In this exercise, you will create a pipe network from an existing polyline. In this method of creating a pipe network, you use standard AutoCAD drawing commands to create a polyline, and then automatically place a pipe endpoint and structure at each polyline vertex.

You can create a pipe network from a variety of entities, including 2D and 3D polylines, AutoCAD lines and arcs, and feature lines. In this exercise, you will use an existing 2D polyline.

For more information, see the AutoCAD Civil 3D Help topic *Creating Pipe Networks from Objects*.

Create a pipe network from a 2D polyline

- 1 Open drawing *Pipe Networks-1A.dwg*, which is located in the [tutorial drawings folder](#) (page 819).

This drawing contains existing ground and corridor surfaces, alignments that represent intersecting road centerlines, parcels that represent property boundaries, and a polyline that represents the proposed pipe network layout. In the following steps, you will create an AutoCAD Civil 3D pipe network from the polyline.

- 2 Click Home tab ► Create Design panel ► Pipe Network drop-down ► Create Pipe Network From Object .
- 3 Click the left end of the blue polyline that is near the center of the road. The end that you click specifies the beginning of the pipe network. The network will flow away from this end.

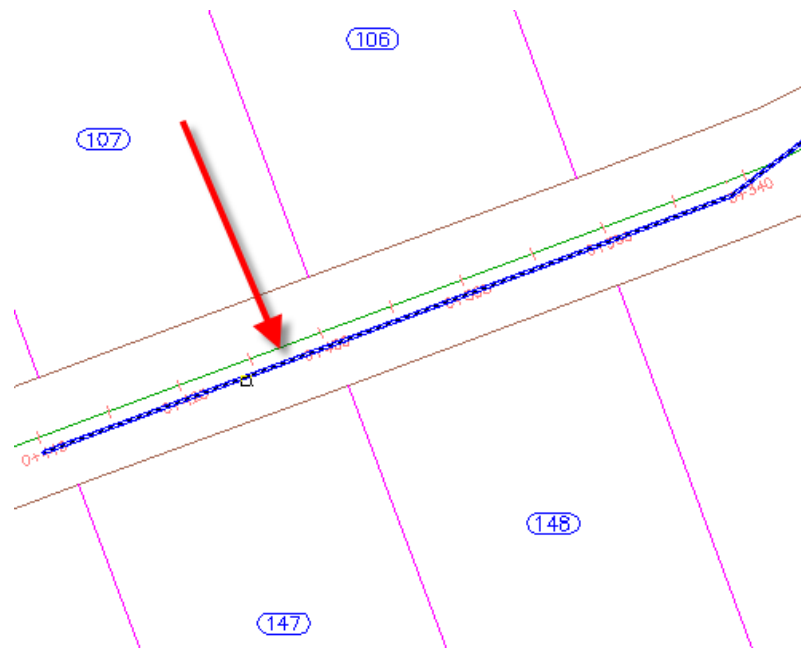

- 4 Press Enter to accept the flow direction.
- 5 In the Create Pipe Network From Object dialog box, specify the following parameters:
 - Network Name: Storm Sewer Network
 - Network Parts List: Storm Sewer
 - Pipe To Create: 450 mm RCP
 - Structure To Create: Eccentric Structure 1,500 dia 530 Frame 900 Cone
 - Surface Name: First Street
 - Alignment Name: First Street
 - Erase Existing Entity: Selected
- 6 Click OK.

The pipe network is displayed in plan. A structure was created at each polyline vertex, and a pipe was created between the structures.

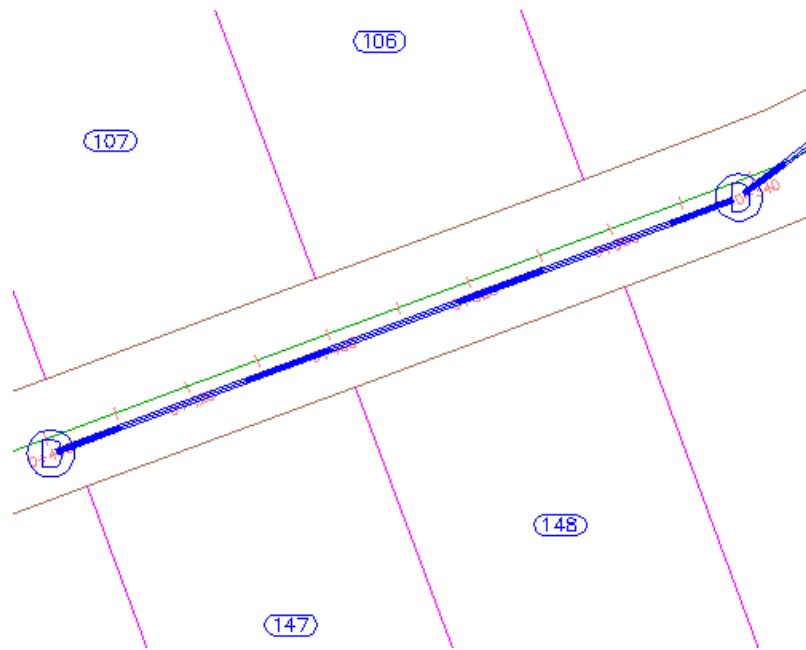

View the pipe network in profile

- 1 Select a pipe and a structure.
- 2 Right-click. Click Select Similar.
- 3 Right-click. Click Draw Parts In Profile View.
- 4 Click the First Street Profile view.

The pipes and structures are displayed in the profile view. Notice that as you specified, the direction of flow begins at the end station of the profile, and proceeds toward the beginning station.

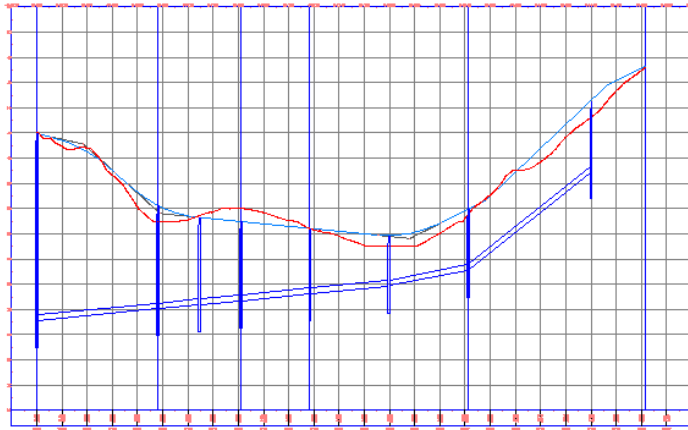

5 Press Esc.



Grip edit a network part

- 1 Select the pipe on the far right side of the profile view.
- 2 Click the  grip. Drag the grip up to increase the invert elevation. Click to place the grip.

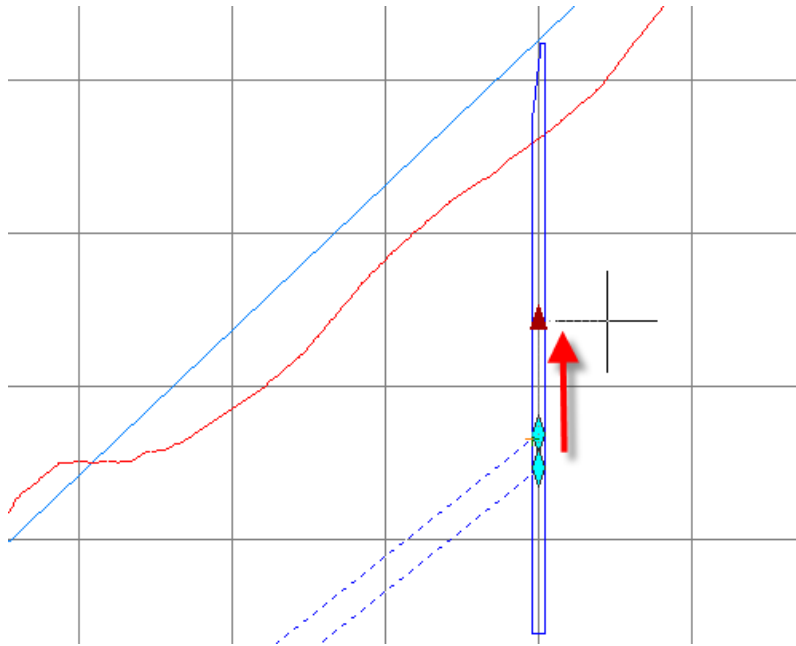
You can use grips to graphically change the position of pipes and structures in both plan and profile.



Edit network parameters

- 1 Right-click. Click Edit Network.
- 2 In the Network Layout Tools toolbar, click the arrow next to  .
These tools enable you to add pipes or structures to the network using the parameters you set on this toolbar.
- 3 Click  Pipe Network Vistas.
On the Panorama window, you use the Pipes and Structures tabs to edit pipes parametrically.
- 4 On the Pipes tab, in the **Pipe - (1)** row, change the Start Invert Elevation value to **40**.
- 5 On the Network Layout Tools toolbar, click  Pipe Network Vistas.
The pipe invert elevation changes to the specified value.

To continue this tutorial, go to [Exercise 2: Creating a Pipe Network by Layout](#) (page 635).

Exercise 2: Creating a Pipe Network by Layout

In this exercise, you will create a pipe network using the AutoCAD Civil 3D pipe network layout tools. The pipe network is associated with a surface and alignment, and uses parts taken from a standard parts list.

For more information, see the AutoCAD Civil 3D Help topic *Creating Pipe Networks Using the Layout Tools*.

This exercise continues from [Exercise 1: Creating a Pipe Network from a Polyline](#) (page 630).

Specify pipe network creation parameters





- 1 Open *Pipe Networks-1B.dwg*, which is located in the [tutorial drawings folder](#) (page 819).

This drawing contains an existing ground surface, an alignment, and existing ground and layout profiles for the alignment. It also contains a surface exported from a corridor that uses the alignment as its baseline.

- 2 In the drawing window, zoom to the area on the alignment between station 7+00 and 11+00.
- 3 In Toolspace, on the Prospector tab, expand the Pipe Networks collection, then right-click Networks. Click Create Pipe Network By Layout.
Alternatively, you can click Home tab ► Create Design panel ► Pipe Network drop-down ► Pipe Network Creation Tools .
- 4 To select the surface taken from the corridor, in the Create Pipe Network dialog box, in the Surface Name list, select ROAD1_SURF.
- 5 In the Alignment Name list, select ROAD1.
- 6 Click OK.

The new pipe network is added to the Toolspace Prospector tab, Pipe Networks ► Networks collection, and the Network Layout Tools toolbar is displayed. The network currently is empty. You will add parts to the network in the following steps.

Draw contiguous pipes and structures

- 1 On the Network Layout Tools toolbar, in the Structure List, expand Eccentric Cylindrical Structure. Select Eccentric Structure 48 Dia 18 Frame 24 Cone 5 Wall 6 Floor.
- 2 In the Pipes List, expand Concrete Pipe. Select 18 Inch Concrete Pipe.
- 3 Ensure that  Pipes and Structures is selected.
- 4 Ensure the Upslope/Downslope option is set to  (downslope).
- 5 On the command line, enter 'SO to activate the Station Offset Civil Transparent command.
- 6 In the drawing window, click one of the alignment station labels to select the alignment ROAD1.
- 7 On the command line, enter 700 as the station.
- 8 On the command line, enter -15 as the offset.
A catch basin is placed at the specified point. The offset is designed to position the catch basin so that its outside edge is flush with the outside edge of the road shoulder.
- 9 With the Station Offset command still active, create another structure by entering 800 for the station and -15 as the offset.
A second catch basin is created. The two structures are connected by a pipe of the type specified in the Pipe list. The pipes follow a downhill slope based on the corridor surface terrain and the design rules for the type and size of pipe. Later, you will view the vertical placement of the pipes you created in a profile view.
- 10 To change the direction of the vertical pipe network layout, toggle the  Upslope/Downslope button to .
- 11 With the Station Offset command still active, create additional structures with an offset of -15 at stations 9+50, 11+00, and 12+50.
As you place the catch basins, connecting pipes are created with slope values specified by the design rules and the Upslope/Downslope setting.
- 12 Press Enter to end the Station Offset command.

Draw a curved pipe with a structure

- 1 Pan until you can see the segment of the alignment between station 12+50 and Station 13+00.
- 2 With the drawing command still active, on the command line, enter C to begin creating a curved pipe.
- 3 On the command line, enter 'SO.
- 4 Create a structure at the end of the curved pipe by entering 1300 for the station and -15 as the offset.
- 5 Press Enter to end the Station Offset command.
- 6 Press Enter to end the drawing command.

To continue this tutorial, go to [Exercise 3: Adding Parts to a Pipe Network](#) (page 637).

Exercise 3: Adding Parts to a Pipe Network

In this exercise, you will add to your pipe network by creating pipes and structures that connect to existing structures.

Whenever you are laying out a pipe network, you have the option of connecting to existing pipe network parts. AutoCAD Civil 3D gives you visual cues when the pipe or structure you are creating will either connect to an existing object or break a pipe to create a junction.



In the previous exercise, you used the Draw Pipes And Structures tool to place structures and pipes simultaneously. In this exercise, you will add catch basins using the Draw Structures Only tool, and then connect the catch basins to network using the Draw Pipes Only tool.

For more information, see the AutoCAD Civil 3D Help topic *Adding a Part to a Pipe Network*.

This exercise continues from [Exercise 2: Creating a Pipe Network by Layout](#) (page 635).

NOTE This exercise uses *Pipe Networks-1B.dwg* with the modifications you made in the previous exercise, or you can open *Pipe Networks-1C.dwg* from the [tutorial drawings folder](#) (page 819).

Add structures to the pipe network

- 1 In the drawing, select a pipe network part. Right-click. Click Edit Network.
- 2 In the Structures list, ensure that Eccentric Cylindrical Structure ► Eccentric Structure 48 Dia 18 Frame 24 Cone 5 Wall 6 Floor is selected.
- 3 Toggle the Upslope/Downslope option to  (downslope).
- 4 Click  Structures Only.
- 5 On the command line, enter 'SO.
- 6 Click a label on the ROAD1 alignment to select it.
- 7 Create a structure by entering 960 for the station and 15 as the offset.
- 8 Repeat Step 7 to add structures that are offset 15 feet from stations 11+10, 12+60, and 13+10.
- 9 Press Enter twice to exit the Station Offset and Add Structures commands.

Add pipes to the pipe network

- 1 In the Pipes list, ensure that 18 Inch Concrete Pipe is selected.
- 2 On the Network Layout Tools toolbar, click Pipes Only.
- 3 Place the cursor over the structure that is offset 15 from station 9+60.

A connection marker  that indicates that the pipe can be attached to the structure is displayed.
- 4 With the connection marker displayed, click the structure to connect the new pipe to it.
- 5 Place the cursor over the structure that is offset -15 feet from station 9+50. With the connection marker displayed, click the structure to connect the new pipe to it.
- 6 On the command line, enter S to select a new start point.
- 7 Repeat Steps 3 through 6 to add pipes between the structures that are offset 15 feet from stations 11+10, 12+60, and 13+10 and the main network.
- 8 Press Enter twice to exit the Station Offset and Add Pipes commands.

To continue to the next tutorial, go to [Changing Pipe Network Properties](#) (page 639).

Tutorial: Changing Pipe Network Properties

This tutorial demonstrates how to add parts to your pipe network parts list. You will also learn how to change the surface, alignment, and design rules that are referenced when you are laying out a pipe network.

In the previous tutorial, the storm system parts you used were designed for a roadway design and took their placement and elevation from the road surface. In this tutorial, you create a branch for the pipe network that travels off the road surface into unfinished terrain, using manholes to connect the pipes and terminating in a headwall.

In addition to selecting different structures, pipes, and layout modes, you can also use the Network Layout Tools toolbar to change the configuration of your pipe network as you work. As you create your design, you can switch to a different parts list, add parts to the parts list, or change the referenced surface and alignment.

For more information, see the AutoCAD Civil 3D Help topic *Editing Pipe Network Settings*.

Exercise 1: Adding Parts to the Parts List



In this exercise, you will add a new part to the parts list by selecting a part family and size from the pipe network part catalog.

This exercise demonstrates how to access your parts lists from the Network Layout Tools toolbar. You can also create, view, and edit parts lists using the Toolspace Settings tab.

For more information, see the AutoCAD Civil 3D Help topic *Part Catalog and Parts List*.

Add a part family to the pipe network parts list

- 1 Open *Pipe Networks-2.dwg*, which is located in the [tutorial drawings folder](#) (page 819).
- 2 In the drawing window, click a pipe network part.
- 3 Click Pipe Networks tab ► Modify panel ► Edit Pipe Network .

- 4 On the Network Layout Tools toolbar, click .
- 5 In the Select Parts List dialog box, click  Edit Current Selection.
- 6 In the Network Parts List dialog box, on the Structures tab, right-click the parts list name in the tree view. Click Add Part Family.
- 7 In the Part Catalog dialog box, under Inlet-Outlets, select Concrete Rectangular Headwall. Click OK.
The new part family is added to the tree view.
- 8 On the Structures tab, in the tree view, notice that no part sizes are available in the Concrete Rectangular Headwall family. You will add them in the following steps.
- 9 Right-click Concrete Rectangular Headwall, and click Add Part Size.
- 10 In the Part Size Creator dialog box, click the Headwall Base Width row. In the Add All Sizes cell, select the check box. Click OK.
- 11 Expand Concrete Rectangular Headwall.
Notice that all available part sizes were added to the tree view. Notice that for each part in the list you can select an object style, design rules, and a render material.
- 12 On the Pipes tab, in the tree view, right-click Concrete Pipe. Click Add Part Size.
- 13 In the Part Size Creator dialog box, click the Inner Pipe Diameter row. Click the Value cell. From the value list, select 24.000000. Click OK.
The new part size is added to the tree view.
- 14 Click OK to close the Network Parts List dialog box.
- 15 Click OK to close the Select Parts List dialog box.

To continue this tutorial, go to [Exercise 2: Changing the Surface, Alignment, and Rules Configuration](#) (page 640).

Exercise 2: Changing the Surface, Alignment, and Rules Configuration

In this exercise, you will change the surface and alignment that are referenced by the pipe network parts. You will also examine the design rules for a part.

AutoCAD Civil 3D uses the referenced surface, alignment, and rules to determine the size and placement of pipe network parts. For example, if you create a manhole structure, the top rim of the structure is typically automatically placed at the elevation of the referenced surface. If the design rules for the manhole specify an adjustment value for rim of the structure, the rim is placed at the surface elevation plus or minus the adjustment value.

For more information, see the AutoCAD Civil 3D Help topic *Part Rules*.

This exercise continues from [Exercise 1: Adding Parts to the Parts List](#) (page 639).

Change the referenced surface



NOTE This exercise uses *Pipe Networks-2.dwg* with the modifications you made in the previous exercise, or you can open *Pipe Networks-2B.dwg* from the [tutorial drawings folder](#) (page 819).



- 1 If the Network Layout Tools toolbar is not already open, select a pipe network part. Right-click. Click Edit Network.
- 2 On the Network Layout Tools toolbar, click .
- 3 In the Select Surface dialog box, select EG. Click OK.

Change the referenced alignment

- 1 Click .
- 2 In the Select Alignment dialog box, select XC_STORM.
- 3 Click OK.

Change the rule set

- 1 Click .
- 2 In the Select Parts List dialog box, click  Edit Current Selection.
- 3 In the Network Parts List dialog box, on the Structures tab, expand Eccentric Cylindrical Structure. Click Eccentric Structure 48 Dia 18 Frame 24 Cone 5 Wall 6 Floor.
- 4 In the Rules cell, click .

- 5 In the Structure Rule Set dialog box, click  Edit Current Selection.
- 6 In the Structure Rule Set dialog box, click the Rules tab.
The selected design rules specify that the structure has a maximum drop value of 3.000' and maximum pipe diameter or width of 4.000'. You can modify these values, or click Add Rule to add another rule.
- 7 Click Cancel twice.
- 8 On the Pipes tab, expand Standard then Concrete Pipe. Click 24 Inch Concrete Pipe.
- 9 In the Rules cell, click . In the Pipe Rules Set dialog box, click  Edit Current Selection. In the Pipe Rule Set dialog box, click the Rules tab.
The selected design rules allow pipes of a maximum length of 200 feet, which is typical of a pipe layout that travels through open terrain.
- 10 Click OK four times.

To continue this tutorial, go to [Exercise 3: Adding a Branch to a Pipe Network](#) (page 642).

Exercise 3: Adding a Branch to a Pipe Network

In this exercise, you will add a branch to the existing pipe network layout and use the part status to review and edit the layout.

In addition to indicator icons that indicate where parts can be connected, you will see icons when the pipe or structure you are adding to the layout will break an existing pipe. The pipes created by the break are automatically connected to the new structure or pipe.

For more information, see the AutoCAD Civil 3D Help topic *Adding a Part to a Pipe Network*.

This exercise continues from [Exercise 2: Changing the Surface, Alignment, and Rules Configuration](#) (page 640).

Add a headwall structure to the pipe network

NOTE This exercise uses *Pipe Networks-2B.dwg* with the modifications you made in the previous exercise.

- 1 If the Network Layout Tools toolbar is not already open, select a pipe network part. Right-click. Click Edit Network.
- 2 On the Network Layout Tools toolbar, ensure that the surface EG and the alignment XC_STORM are selected.
For more information, see [Exercise 2: Changing the Surface, Alignment, and Rules Configuration](#) (page 640).
- 3 In the Structures list, expand the Concrete Rectangular Headwall collection. Select 44 x 6 x 37 Inch Concrete Rectangular Headwall.
- 4 Click  Structures Only.
- 5 In the drawing window, zoom to station 4+00 on XC_STORM.
- 6 Click near the alignment to place the headwall structure.

Connect the headwall structure to the pipe network

- 1 On the Network Layout Tools toolbar, click Pipes Only.
- 2 In the Pipes list, expand the Concrete Pipe collection. Select 24 Inch Concrete Pipe.
- 3 Toggle the Upslope/Downslope button to  Upslope.
- 4 Hover the cursor over the rectangular headwall structure. With the connection marker displayed, click to connect the pipe.
- 5 Pan to the structure that is offset -15 feet from station 8+00 on ROAD1.
- 6 Hover the cursor over the structure. With the connection marker displayed, click the structure to connect the pipe.
- 7 Press Enter to end the command.

Rotate the headwall structure

- 1 Pan to the headwall at the end of the branch. Click the headwall to select it.

- 2 Use the circular editing grip to rotate the headwall until it is perpendicular to the attached pipe.
- 3 Press Esc to deselect the headwall.

Validate that design rules have been met

- 1 In Toolspace, on the Prospector tab, expand Pipe Networks ► Networks ► Network - (1). Click Pipes.
- 2 In the item view, in the row for Pipe - (10), place your cursor over the circular icon in the Status cell to view the design rules that have not been met.
The pipe exceeds the maximum length and maximum cover found in the rules. In the next few steps, you will correct the length by adding a structure to the middle of the pipe span.
- 3 Right-click the row for Pipe - (10). Click Zoom To.
The full extents of the pipe are displayed in the drawing window.

Insert a structure in the middle of a pipe

- 1 On the Network Layout Tools toolbar, in the Structures list, select Eccentric Cylindrical Structure ► Eccentric Structure 48 Dia 18 Frame 24 Cone 5 Wall 6 Floor.
- 2 Click  Structures Only.
- 3 In the drawing window, pan to station 2+00 on alignment XC_STORM.

NOTE You must turn off OSNAP to complete the following steps.

- 4 Place your cursor over a location on the pipe that is close to station 2+00.
A break pipe marker is displayed  to indicate that the pipe will be severed by placing the structure there.

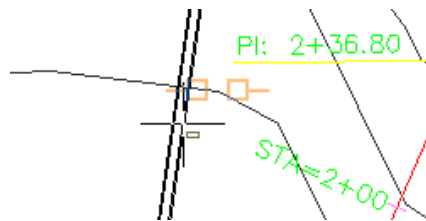

- 5 With the break pipe marker displayed, click to place the manhole at the location, and create two pipes from the one.
- 6 Press Enter to end the command.

To continue to the next tutorial, go to [Viewing and Editing Pipe Networks](#) (page 645).

Tutorial: Viewing and Editing Pipe Networks

This tutorial demonstrates how you can view and edit the parts of your pipe network in profile and section views.

You can draw some or all of the parts of a pipe network in a profile view. After the parts are drawn in a view, you can adjust their vertical layout by either grip editing or directly editing the values found in tabular format in the part properties dialog box. You also can add tables to organize pipe network part data, and label the parts to make them easy to identify.

When you create a section view, any pipe network parts that are located at the cross-section are drawn in the view.

For more information, see the AutoCAD Civil 3D Help topic *Editing Pipe Networks*.

Exercise 1: Drawing Pipe Network Parts in a Profile View

In this exercise, you will draw the pipe network parts in a profile view.

For more information, see the AutoCAD Civil 3D Help topic *Displaying Pipe Networks in Profile View*.

This exercise uses the pipe network and branch you created in the [Changing Pipe Network Properties](#) (page 639) tutorial.

Draw pipe network parts in a profile view

- 1 Open *Pipe Networks-3.dwg*, which is located in the [tutorial drawings folder](#) (page 819).
- 2 In the drawing window, zoom to a section of the pipe network.
- 3 Click a pipe to select it. Right-click. Click Draw Parts In Profile View.
- 4 Zoom to the profile for the alignment that represents the road (PV - 1). Click the profile grid.

The pipe or structure you selected is drawn in the profile view.

- 5 Press Esc to deselect the pipe.
- 6 Select the profile view grid. Right-click. Click Profile View Properties.
- 7 In the Profile View Properties dialog box, on the Pipe Networks tab, select the check box in the Draw column for each part entry in the pipe network except for Pipe - (10), Pipe - (10)(1), Structure (11), and Structure (12).
- 8 Click OK.
All the pipe network parts you selected in Profile View Properties are displayed in the profile view.

To continue this tutorial, go to [Exercise 2: Adding Labels to Pipe Network Parts](#) (page 646).

Exercise 2: Adding Labels to Pipe Network Parts

In this exercise, you will add labels to the pipe network parts drawn in both plan and profile views.

NOTE For more detailed tutorials on labels, go to the [Labels and Tables Tutorials](#) (page 739).

For more information, see the AutoCAD Civil 3D Help topic *Labeling Pipe Networks*.

This exercise continues from [Exercise 1: Drawing Pipe Network Parts in a Profile View](#) (page 645).





Add labels to pipe network parts in a profile

NOTE This exercise uses *Pipe Networks-3.dwg* with the modifications you made in the previous exercise.

- 1 Zoom to the pipe network parts drawn in the profile view.
- 2 Click Annotate tab ► Labels & Tables panel ► Add Labels menu ► Pipe Network ► Add Pipe Network Labels .
- 3 In the Add Labels dialog box, specify the following parameters:
 - Label Type: Single Part Profile
 - Pipe Label Style: Standard

- 4 Click Add.
- 5 In the drawing window, click Pipe - (1), which is between stations 7+00 and 8+00 of the layout profile displayed in the profile view.
The pipe is labeled with its description. In the following steps, you will create a label style that displays the elevation of the start invert of the pipe.

Create a pipe label style

- 1 In the Add Labels dialog box, next to the Pipe Label Style list, click the arrow next to . Click  Copy Current Selection.
- 2 In the Label Style Composer dialog box, on the Information tab, for Name, enter Start Invert Elevation.
- 3 On the Layout tab, click the Contents value under Text. Click .
- 4 In the Text Component Editor dialog box, on the Properties tab, in the Properties list, select Start Invert Elevation.
- 5 Click .
- 6 In the text editor window, click the <[Description(CP)]> property field. Press Delete.
- 7 Your label content should look like this:

```
<[Start Invert Elevation(Uft|P3|RN|AP|Sn|DF)]>
```
- 8 Click OK twice.
- 9 In the Add Labels dialog box, specify the following parameters:
 - Label Type: Single Part Profile
 - Pipe Label Style: Start Invert Elevation
- 10 Click Add.
- 11 In the profile view, click Pipe - (2), which is between stations 8+00 and 9+50 of the layout profile.
- 12 Press Esc to end the add label command.
- 13 Click the label text to select the label.

- 14 Click the diamond-shaped label edit grip to make it active. Click a new location for the label at the start end of the pipe, which is the end located next to station 8+00.
The start and end of a pipe is determined using the direction in which the pipe was drawn.
- 15 Click the square label edit grip to make it active. Click a new location for the label text that moves it off the pipe.
- 16 Press Esc to deselect the label.
Next, you will add a spanning label to a series of two pipes in plan view.

Add labels to a single pipe network part in plan view

- 1 Pan and zoom until you can clearly see the North-South pipe run along the XC_STORM alignment.
- 2 In the Add Labels dialog box, specify the following parameters:
 - Label Type: Spanning Pipes Plan
 - Pipe Label Style: 2D Length - Total Span
- 3 Click Add.
- 4 Click both pipes along the XC_STORM alignment, then press Enter.
- 5 When prompted, click a location along the pipe span to place the label.
The span label is placed on the pipe run in the location you specified. To see which pipes are included in the span, hover the cursor over the label to highlight the pipes.

Add labels to a multiple pipe network parts in plan view

- 1 Pan and zoom until you can clearly see the plan view of the pipe network.
- 2 In the Add Labels dialog box, specify the following parameters:
 - Label Type: Entire Network Plan
 - Pipe Label Style: Standard
 - Structure Label Style: Structure Name
- 3 Click Add.
- 4 Click a part in the pipe network. All pipes and structures are labeled using the styles you selected.

- 5 In the Add Labels dialog box, click Close.

To continue this tutorial, go to [Exercise 3: Editing Pipe Network Parts in a Profile View](#) (page 649).

Exercise 3: Editing Pipe Network Parts in a Profile View

In this exercise, you will edit the pipe network parts drawn in a profile view using editing grips and by directly editing the part properties.

For more information, see the AutoCAD Civil 3D Help topic *Editing Pipe Networks Using Grips*.

This exercise continues from [Exercise 2: Adding Labels to Pipe Network Parts](#) (page 646).

Grip edit pipe network parts in profile view

NOTE This exercise uses *Pipe Networks-3.dwg* with the modifications you made in the previous exercise, or you can open *Pipe Networks-3B* from the [tutorial drawings folder](#) (page 819).

- 1 In the profile view for ROAD1 (PV - (1)), click Pipe - (4), which connects the structures that are offset from stations 11+00 and 12+50 on ROAD1.
- 2 Click the square editing grip at the center of the pipe to make it active. Click a new vertical location for the pipe so the start invert elevation is approximately 650 feet.

NOTE The horizontal grid line immediately below the pipe indicates 650 feet.

As you move your cursor, the tooltip displays the current elevation of the active grip.

- 3 Click the triangular grip at the start (downslope) end of the pipe to make it active. Click a new position for the pipe end so that it aligns with the end invert elevation of Pipe - (3), which is between stations 11+00 and 9+50.

Parametrically edit pipe network parts in profile view

- 1 With Pipe - (4) still selected, right-click. Click Pipe Properties.

- 2 In the Pipe Properties dialog box, on the Part Properties tab, click the Start Invert Elevation value to select it. Press Ctrl+C to copy the value.
- 3 Click OK.
- 4 Press Esc to deselect Pipe - (4).
- 5 Click Pipe - (3) to select it. Right-click. Click Pipe Properties.
- 6 In the Pipe Properties dialog box, on the Part Properties tab, under Geometry, click the End Invert Elevation value to select it. Press Ctrl+V to replace the value with the one copied from Pipe - (4).
- 7 Click OK.
Pipe - (3) and Pipe - (4) now connect to Structure - (4) at the same invert elevation.
- 8 Press Esc to deselect the pipe.

TIP You also can use OSNAPs to quickly match pipe start and end elevations. For more information, see the [Using Basic Functionality tutorial exercise](#) (page 15).

Further exploration: Repeat the editing procedures with Pipe - (5), which is between stations 12+50 and 13+00, to create a continuous flow line for the pipes.

To continue this tutorial, go to [Exercise 4: Overriding the Style of a Pipe Network Part in a Profile View](#) (page 650).

Exercise 4: Overriding the Style of a Pipe Network Part in a Profile View

In this exercise, you will change the style used by pipe network parts in a profile view using override settings found in the profile view properties.

For more information, see the AutoCAD Civil 3D Help topic *Displaying Pipe Networks in Profile Views*.

This exercise continues from [Exercise 3: Editing Pipe Network Parts in a Profile View](#) (page 649).

Override the style of an object in a profile view

NOTE This exercise uses *Pipe Networks-3B.dwg* with the modifications you made in the previous exercise.

- 1 In the drawing, zoom to the profile view of ROAD1 (PV- (1)).
- 2 Click the profile view to select it. Right-click. Click Profile View Properties.
- 3 On the Pipe Networks tab, click the Pipe - (6) row.
- 4 Scroll to the right until you can see the Style Override value.
- 5 Click the Style Override cell.
- 6 In the Pick Pipe Style dialog box, select Dotted. Click OK.
- 7 Repeat steps 5 and 6 to override style for Pipe - (7), Pipe - (8), and Pipe - (9).
- 8 Click OK.

The pipes that cross the road are now displayed using dotted lines, making it easier to view and edit the main pipe segment. You may have to enter REGEN on the command line to see the style change.

Change the structure style display in profile

- 1 Pan and zoom until you can clearly see the structure at station 8+00.
Notice that there is no indication of the pipe segment that travels along the XC-STORM alignment. In the next few steps, you will change the structure style to display where a perpendicular pipe connects to a structure.
- 2 Click the structure to select it. Right-click. Select Edit Structure Style.
- 3 In the Structure Style dialog box, on the Display tab, in the View Direction list, select Profile. Make the Structure Pipe Outlines component visible and change its color to red.
- 4 Click OK. Notice that a red circle now appears in the structure. The red circle indicates the location of a perpendicular connection of a pipe that is not displayed in the profile view.

To continue this tutorial, go to [Exercise 5: Viewing Pipe Network Parts in a Section View](#) (page 652).

Exercise 5: Viewing Pipe Network Parts in a Section View

In this exercise, you will view the pipe network parts in a section view.

For more information, see the AutoCAD Civil 3D Help topic *Displaying Pipe Networks in Section Views*.

This exercise continues from [Exercise 4: Overriding the Style of a Pipe Network Part in a Profile View](#) (page 650).

Create a sample line

NOTE This exercise uses *Pipe Networks-3B.dwg* with the modifications you made in the previous exercise, or you can open *Pipe Networks-3C* from the [tutorial drawings folder](#) (page 819).

- 1 In the drawing, zoom to the area around station 12+60 on the ROAD1 alignment.
- 2 Click Home tab ► Profile & Section Views panel ► Sample Lines .
- 3 Press Enter when prompted to select an alignment.
- 4 In the Select Alignment dialog box, select ROAD1. Click OK.
- 5 In the Create Sample Line Group dialog box, click OK.
- 6 On the command line, enter 1260.
- 7 For the left swath width, enter 20.
- 8 For the right swath width, enter 20.
The sample line is created at the specified station.
- 9 Press Enter to end the sample line creation command.

Create a section view

- 1 Click Home tab ► Profile & Section Views panel ► Section Views drop-down ► Create Section View .
- 2 In the Create Section View wizard, click Section Display Options.
- 3 On the Section Display Options page, in the Select Sections To Draw list, in the ROAD1_SURF row, click the Change Labels cell.
- 4 In the Select Style Set dialog box, select No Labels. Click OK.

- 5 Repeat Steps 3 and 4 to apply the No Labels label style set to the entries in the Change Labels column.
- 6 Click Create Section View.
- 7 Zoom and pan to a location for the section view.
- 8 Click to create the section view at your selected location.
- 9 If a warning event is displayed, close the Event Viewer window.
- 10 Zoom and pan to the section view to see the pipe network parts in the section view.

To continue this tutorial, go to [Exercise 6: Creating Pipe and Structure Tables](#) (page 653).

Exercise 6: Creating Pipe and Structure Tables

In this exercise, you will create a table that displays information about the structures in a pipe network. Then, you will create a table style to display other information.

The procedures for creating pipe and structure tables are very similar. While this exercise focuses on structure tables, you can use the same procedure to create pipe tables.

NOTE For more detailed tutorials on tables, go to the [Labels and Tables Tutorials](#) (page 739).

For more information, see the AutoCAD Civil 3D Help topic *Adding Pipe Tables* and *Adding Structure Tables*.

This exercise continues from [Exercise 5: Viewing Pipe Network Parts in a Section View](#) (page 652).





To create a structure table

NOTE This exercise uses *Pipe Networks-3C.dwg* with the modifications you made in the previous exercise.

- 1 Click Annotate tab ► Labels & Tables panel ► Add Tables menu ► Pipe Network ► Add Structure .

- 2 In the Structure Table Creation dialog box, select By Network and click OK.
- 3 Pan to a clear area in the drawing window and click to place the table.
- 4 Zoom and pan to the structure table. Examine the contents of the table. Next, you will change the contents of the table by creating a table style.

Change the table contents by creating a new style

- 1 Select the table by clicking one of the rulings. Right-click the structure table and select Table Properties.
- 2 In the Table Properties dialog box, under Table Style, click the down arrow next to . Click  Copy Current Selection.
- 3 In the Table Style dialog box, on the Information tab, change the Name to Structure Stations and Details.
- 4 On the Data Properties tab, specify the following parameters:
 - Sort Data: Selected
 - Sorting Column: 1
 - Order: Ascending
These settings ensure that the table rows are sorted in ascending order by the first column.
- 5 In the Structure area, click  to add a new column to the table.
- 6 Double-click the new column's heading cell.
- 7 In the Text Component Editor dialog box, in the preview pane, enter Station. Click OK.
- 8 In the Table Style dialog box, in the Structure area, double-click in the Column Value cell in the Station column.
- 9 In the Table Cell Components dialog box, in the Text Contents row, click in the Value cell. Click .
- 10 In the Text Component Editor dialog box, select the data that appears in the preview area and press Delete.
- 11 In the preview area, enter STATION = .

- 12** In the Properties list, select Structure Station. Change the Precision value to 1 then click  .
- 13** Click OK twice.
- 14** In the Table Style dialog box, click the heading cell of the Station column, and then drag the Station column over the Structure Details column. The Station column is placed between the Structure Name and Structure Details columns.
- 15** Click OK twice.
The table now displays the station at which each structure is located.

Part Builder Tutorials

18

These tutorials demonstrate how to work with the Part Builder features, which you use to design and model parts (pipes and structures) that are used in pipe networks.

NOTE If you have not installed AutoCAD Civil 3D to the default location, you may receive messages in the Event Viewer, indicating that pipe network part catalogs are not found. To avoid these messages, it is recommended that you follow the exercises in the order presented. Alternatively, you can reset the path to the catalogs by clicking Home tab ► Create Design panel ▾ Set Pipe Network Catalog  .

NOTE All drawings used in these tutorials are available in the [tutorial drawings folder](#) (page 819). If you want to save your work from these tutorials, save the drawings to the [My Civil Tutorial Data folder](#) (page 819) so that you do not overwrite the original drawings.

For more information, see the AutoCAD Civil 3D Help topic *Understanding Part Builder*.

Tutorial: Creating a Cylindrical Manhole Structure

This tutorial demonstrates how use Part Builder to create a cylindrical-shaped storm drainage manhole structure. It will go through the steps to define the new part in the structure catalog, define the manhole geometry, create profiles, and then establish parameters to control the sizing and dimensions of the manhole.

For more information, see the AutoCAD Civil 3D Help topic *Understanding Part Builder*.

Exercise 1: Defining the New Part in the Structure Catalog

In this exercise, you will begin creating a cylindrical-shaped manhole structure in Part Builder by creating a new part chapter, and a new part family within the

Structure catalog. You will also configure work planes in the Part Builder parametric modeling environment so that you can proceed with modeling the part in the subsequent exercises.

Because you will be working within the Part Builder environment, you do not need to have a drawing open to begin this exercise. However, the AutoCAD Civil 3D [tutorial drawings folder](#) (page 819) includes a drawing that contains the completed part—in this case, a cylindrical manhole structure. If desired, before or after completing this exercise, you can open the *Part Builder-1b.dwg* file to see what this finished part looks like.

For more information, see the AutoCAD Civil 3D Help topic *Understanding Part Builder*.

- 1 Click Home tab ► Create Design panel ▼ Part Builder .
- 2 In the Getting Started – Catalog Screen dialog box, in the Part Catalog list, select Structure. Select the Junction Structure With Frames folder, and then click New Parametric Part. The New Part box dialog is displayed.
- 3 For Name, enter “Cylindrical Manhole1.” Click in the box next to Description. The description matches the name by default. Click OK. The Part Builder parametric modeling environment is opened.
- 4 Expand Part Configuration and change the following:
 - Undefined Part Type: change this to Junction Structure
 - Undefined: leave this as Undefined
 - Undefined Bounded Shape: change this to CylinderThe Part is configured as a cylinder shape with the properties of a junction structure.
- 5 Expand Modeling, and then right-click Work Planes and then click Add Work Plane. The Create Work Plane dialog box is displayed.
- 6 Click Top, and then click OK. The Top work plane is created.
- 7 Expand Work Planes. Right-click Top Plane ► Rename, and change the name to Rim.
This work plane will be the rim elevation of the new structure.
- 8 Click Save Part Family. Click Yes. The part is validated and saved.
Note that additional parameters are displayed under the Model Parameters and Size Parameters to reflect the Part Configuration settings established in step 1.

To continue this tutorial, go to [Exercise 2: Defining the Manhole Geometry](#) (page 659).

Exercise 2: Defining the Manhole Geometry

In this exercise, you will define the geometry of the manhole by creating a simple schematic of the structure profile. You will build this portion with dimensions that can be modified from within AutoCAD Civil 3D when the part is in use.

For more information, see the AutoCAD Civil 3D Help topic *Understanding Part Builder*.

This exercise continues from [Exercise 1: Defining the New Part in the Structure Catalog](#) (page 657).

- 1 Click View tab ► Views panel ► Front.

The view of your Part Builder drawing area changes so that you see the Rim work plane from a front view.

- 2 Expand Modeling. Right-click Work Planes and then click Add Work Plane. The Create Work Plane dialog box is displayed.

- 3 Click Offset. Name the work plane Top of Riser 1 then click OK.

- 4 The command line asks you to Select reference work plane. Click the yellow bounding square of the Rim work plane.

The command line asks you to Select Offset from work plane. Turn on ORTHO. Select a location approximately 12" lower than the Rim work plane in the negative Z direction, and press enter. In later steps, you will establish a more precise offset by equating these distances with structure parameters. A second work plane is displayed approximately 12" below the first work plane.

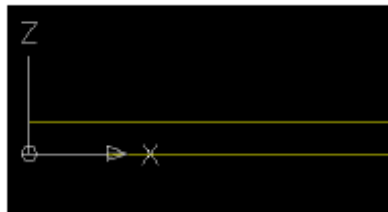

- 5 Repeat Steps 2 through 4 to create the following additional work planes, using the following approximate offsets from the work plane directly above each one:

- Top of Cone: 12"
- Top of Riser 2: 24"
- Top of Barrel: 85"
- Bottom of Structure: 200"

The new work planes are displayed. The new parameters are displayed under Model Parameters showing you the work plane offsets.

- 6 Change your view to be oriented above the Rim work plane. Expand Work Planes, right-click Rim and then click Set View. The view is oriented to be above the Rim work plane.
- 7 Add a circular profile to represent the diameter of the frame. Right-click the Rim work plane ► Add Profile ► Circular. At the command prompt, select a center point for the profile at the approximate center of the work plane and a radius of 12", similar to how you would draw an AutoCAD circle. A circular profile is displayed, and an entry for a circular profile is displayed under the Rim work plane.
- 8 Expand Work Planes, right-click Rim ► Add Geometry ► Point. Place a point at the approximate center of your circular profile. A point is displayed at the approximate center of the circular profile.

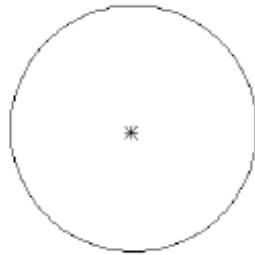

- 9 Constrain the profile so that the point will be forced to always be located at the center of the profile. Right-click the Rim work plane ► Add Constraints ► Concentric. The command line prompts you to select a first geometry and a second geometry. Select the point and the circular profile. The point moves to be at the center of the circular profile, and a concentric constraint is displayed under the Rim work plane.

- 10** Add a diameter dimension that you can later use as a structure parameter. Right-click the Rim work plane ► Add Dimension ► Diameter. The command line prompts you to select circle or arc geometry. Select the circular profile on the screen. The command line prompts you to select a dimension position. Select a location on your screen that is close to the profile, but out of your way. A diameter dimension is displayed on screen as well as under your Model Parameters. The actual drawn diameter and dimension value are unimportant at this time.
- 11** Draw a circular profile on the Top of Riser 1 work plane. Right-click the Top of Riser 1 work plane, and then click Add Profile ► Circular. Following the same procedure as Step 7, draw a circular profile. You can use your center OSNAP to ensure that the center of this profile matches the center of the profile from the Rim work plane. Set the radius to be just slightly larger than the Rim work plane circular profile to ease selection of this profile. The actual radius is not important at this time. A circular profile is displayed.
- 12** Add a diameter dimension to the circular profile on the Top of Riser 1 work plane. Right-click the Top of Riser 1 work plane, and then click Add Dimension ► Diameter. Follow the same procedure as step 10 to place the dimension. A diameter dimension is displayed for your second circular profile.
- 13** Repeat the previous two steps to create a circular profile and corresponding dimension on the Top of Cone work plane. You have three circular profiles with appropriate dimensions. Your dimensions may look different than the following illustration.
- 14** Repeat steps 11 and 12 to create a circular profile and corresponding dimension for the Top of Riser 2 work plane; however, this time, make the profile radius approximately twice as large (approximately 24" radius/48" diameter). You should have four circular profiles displayed, and four corresponding dimensions displayed in the modeling area, and under Model Parameters node.

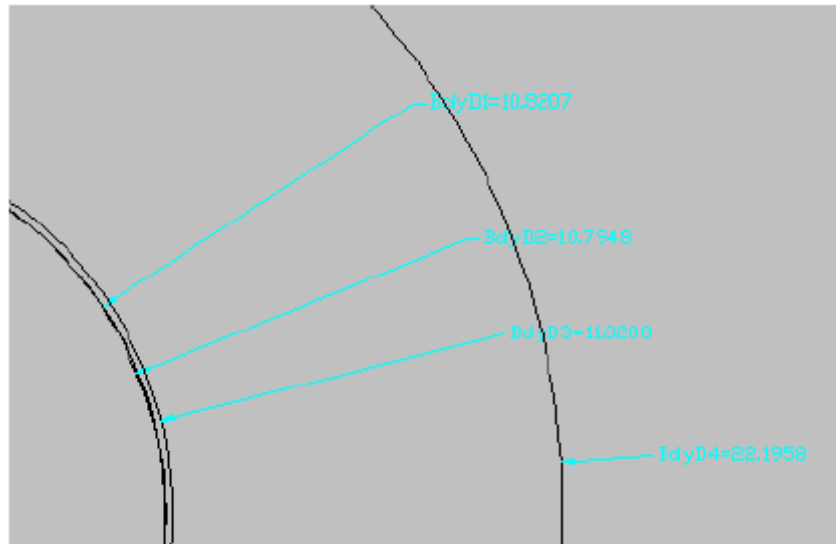

- 15 Click View tab ► Views panel ► Front. Four profiles from front view are displayed.

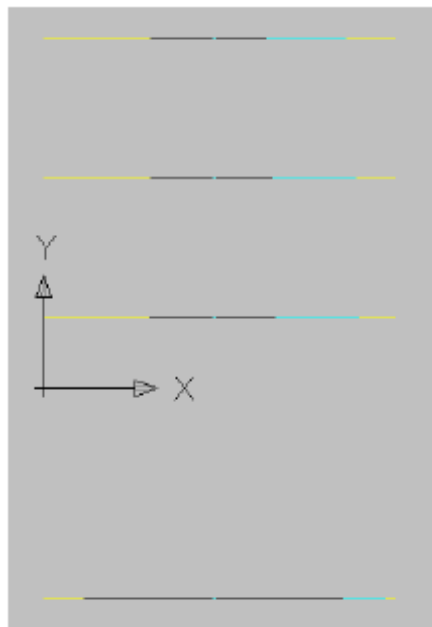

- 16** Add a transition between the Rim circular profile and the Top of Riser 1 circular profile. This represents the manhole cover and frame. Right-click Modifiers and then click Add Transition. The command line prompts you to Select Start Profile. On the screen, select the circular profile on the Rim work plane. The command line prompts you to Select End Profile. On the screen, select the circular profile on the Top of Riser 1 work plane. A transition is displayed similar to the following illustration:

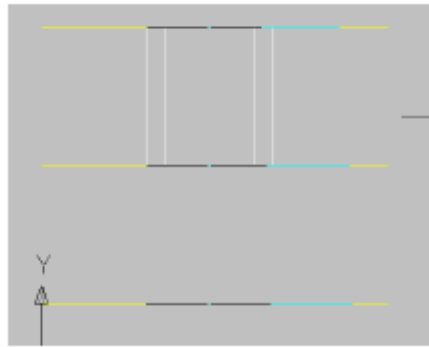

- 17** Right-click the transition on the screen, and then click Display Order ► Send to Back. Add a transition between the Top of Riser 1 circular profile and the Top of Cone circular profile. This represents the manhole cover and frame. Right-click Modifiers and then click Add Transition. The command line prompts you to Select Start Profile. On the screen, select the circular profile on the Top of Riser 1 work plane. The command line prompts you to Select End Profile. On the screen, select the circular profile on the Top of Cone work plane.

Repeat the process to create a transition between the circular profiles on the Top of Cone work plane and the Top of Riser 2 work plane. Remember that you may have to use Display Order ► Send to Back to send the transitions to the back, so that you can choose the profiles. To do this, right-click the transition on the screen, and then click Display Order ► Send to Back. Transitions are displayed similar to the following illustration:

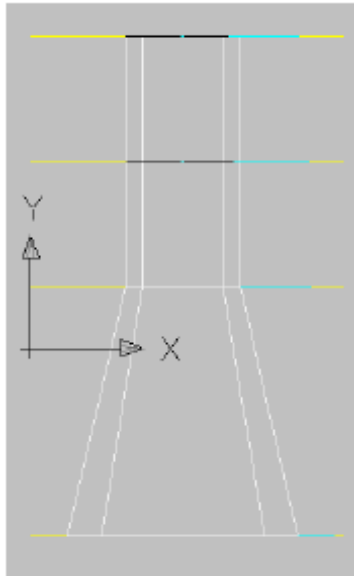

These transitions stay dynamic to profiles used to create them, including adjustments to work plane offsets, and diameter dimensions.

- 18** Switch your view back to an overhead view by selecting the Top of Barrel work plane, right-clicking and choosing Set View. Your view switches to an overhead view in relation to this work plane.
- 19** Make two circular profiles with corresponding dimensions on the Top of Barrel work plane. Use steps 11 and 12 for reference. The first should be approximately the same size as the profile on the Top of Riser 2 work plane (24"R/48"D), the second should be approximately twice as large (48"R/ 96"D). Two circular profiles are displayed on your screen. Two corresponding dimensions are displayed both on screen and under Model Parameters.
- 20** Make one circular profile with a corresponding dimension on the Bottom of Structure work plane. Use steps 11 and 12 for reference. The profile should be approximately the same size as the larger profile on the Top of Barrel work plane (48"R/ 96"D). You should now have seven (7) total circular profiles and corresponding dimensions both on screen and under Model Parameters. Remember that these diameters are approximate at this point. The ones you created may not look exactly like the ones displayed in this tutorial.

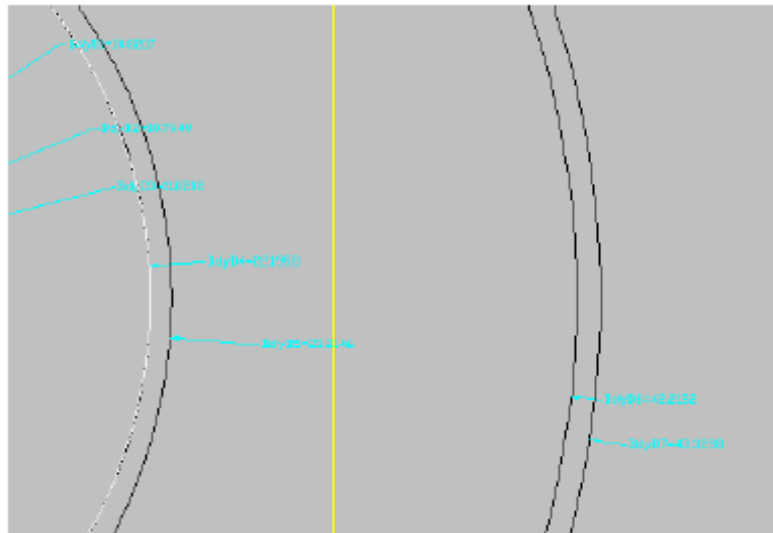

- 21** Change your view to a Front view. The stack of work planes and the transitions created in step 17 are displayed.
- 22** Following the same methodology for the first batch of transitions created in steps 16 and 17, add transitions between the Top of Riser 2 Profile, and the smaller Top of Barrel profile, then the larger Top of Barrel profile and the Bottom of Structure profile. (You may have to use Draw Order to send certain profiles to the back, in order to choose the correct one for each transition.) The model you created should now look similar to the following illustration:

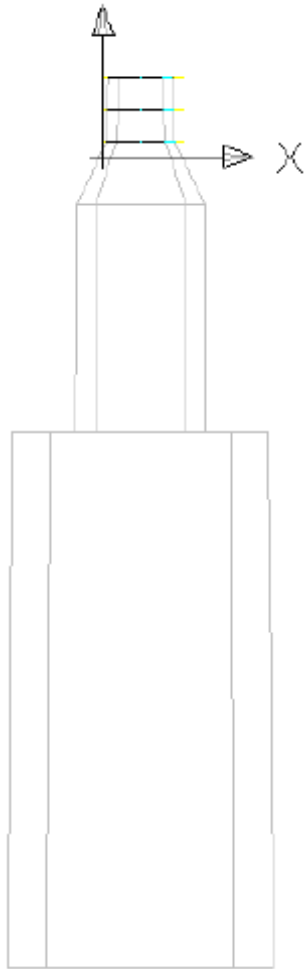

23 Change your view to SW isometric.

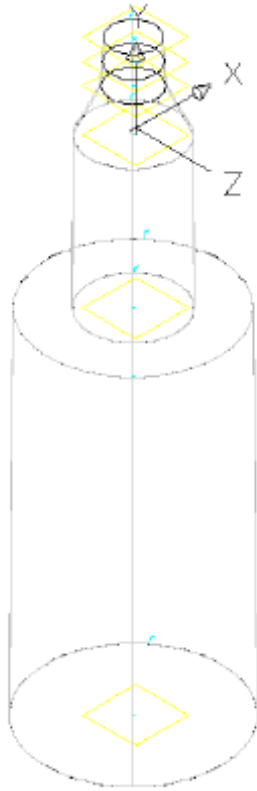

24 Change your visual style to Conceptual.

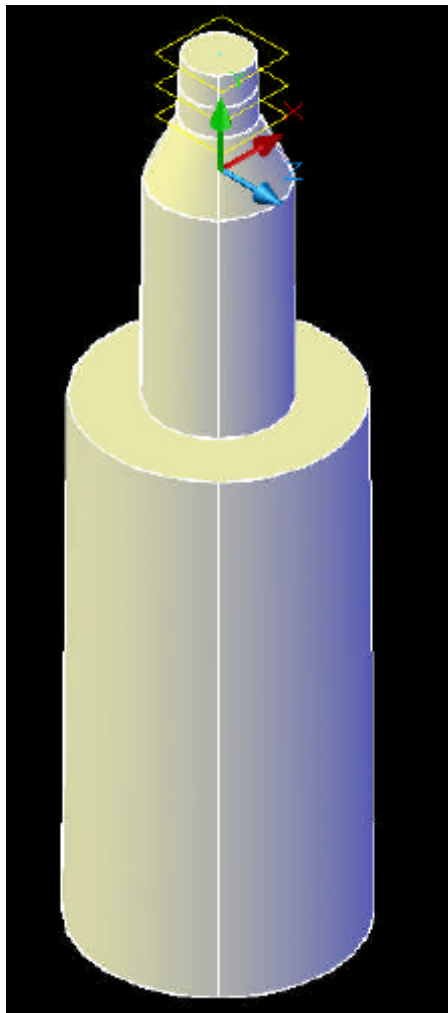

- 25 Change your visual style back to 2D wireframe, then change your view back to Top view.

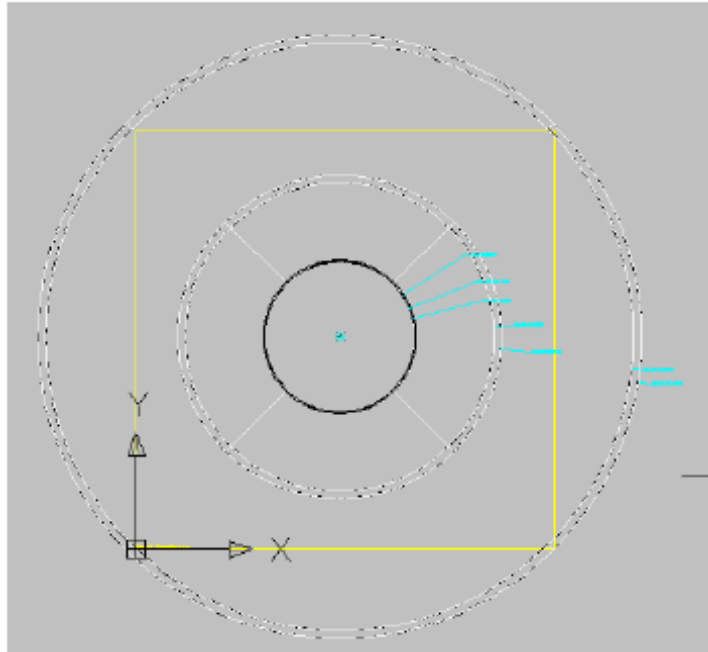

To continue this tutorial, go to [Exercise 3: Matching Offsets and Dimensions to Parameters](#) (page 669).

Exercise 3: Matching Offsets and Dimensions to Parameters

In this exercise, you will match the work plane offsets and diameter dimensions to the parameters. The next step, though, is to create a few more structure parameters.

For more information, see the AutoCAD Civil 3D Help topic *Understanding Part Builder*.

This exercise continues from [Exercise 2: Defining the Manhole Geometry](#) (page 659).

1 Expand Model Parameters and Size Parameters.

Note that there are entries listed for the work plane offsets, structure parameters and body diameter dimensions.

- 2 Right-click Size Parameters and then click Add. The Edit Part Sizes dialog box is displayed, along with the New Parameter dialog box.
- 3 Select Structure Riser Height 1 and press OK. A new parameter of SRZ1 is displayed in the Edit Part Sizes dialog box.
- 4 In the Edit Part Sizes dialog box, click New to display the New Parameter dialog box. Add the following additional parameters using the New Parameter dialog box:
 - Structure Riser Height 2
 - Inner Structure Diameter
 - Frame Diameter
 - Frame Height
 - Cone Height
 - Slab Thickness
 - Barrel Height
 - Barrel Pipe Clearance

Each new parameter is displayed in the Edit Part Sizes dialog box.

- 5 The next step is to assign some preliminary values to the structure parameters. These will be refined later by adding lists of possible structure sizes. Right-click Model Parameters ► Edit. The Model Parameters dialog box is displayed.
- 6 Note that the structure parameters have all been assigned an initial value of zero. Change the numbers in the Equation column to match the following constants (all in inches):
 - FTh = 15
 - SBH = 84
 - SBPC = 72
 - SBSD = 168
 - SBSH = 315
 - SCH = 24
 - SFD = 24

- SFH = 18
- SID = 144
- SRS = 300
- SRZ1 = 8
- SRZ2 = 70
- SSTh = 12
- SVPC = 192

These constants can be changed later to variables, lists, ranges, or tables for further part customization. Keep the Model Parameters dialog box open for the next step.

- 7 Next, you'll change each of the work plane offset parameters (WPOf1 through WPOf5) to correspond with a structure parameter. For example, instead of the first offset being approximately 12", it now corresponds with the SFH parameter. So if you later adjust the SFH parameter, the work plane offset (and its plane geometry, profiles and dimensions) will adjust accordingly.

Select WPOf1, and then select Calculator. The Equation Assistant dialog box is displayed.

- 8 Select the Variable button to use the pull down to select which structure parameter should match this work plane offset. Click SFH. Press OK to exit the Equation Assistant dialog box. The SFH parameter is displayed under the Equation column in the Model Parameters dialog box.

- 9 Repeat the previous two steps for each work plane offset parameter using the following values:

- WPOf2 = SRZ1
- WPOf3 = SCH
- WPOf4 = SRZ2
- WPOf5 = SBSH

Remain in the Model Parameters dialog box for the next step. The following parameters are displayed under the equation column in the Model Parameters dialog box:

WPOf1	8.0000	SFH	Workplane Offset 1
-------	--------	-----	--------------------

WPOf2	8.0000	SRZ1	Workplane Offset 2
WPOf3	24.0000	SCH	Workplane Offset 3
WPOf4	120.0000	SRZ2	Workplane Offset 4
WPOf5	172.0000	SBSH	Workplane Offset 5

10 Next you map each body diameter dimension to a corresponding structure diameter parameter. Using the calculator tool in the Model Parameters dialog box, set the equation column for each body diameter parameter making the following matches:

- BdyD1 = SFD
- BdyD2 = SFD
- BdyD3 = SFD
- BdyD4 = 2*SFD
- BdyD5 = 2*SFD
- BdyD6 = SID
- BdyD7 = SID

The following parameters are displayed under the equation column in the Model Parameters dialog box:

Bdy01	24.0000	SFD	Body Diameter 1
Bdy02	24.0000	SFD	Body Diameter 2
Bdy03	24.0000	SFD	Body Diameter 3
Bdy04	48.0000	2*SFD	Body Diameter 4
Bdy05	48.0000	2*SFD	Body Diameter 5
Bdy06	144.0000	SID	Body Diameter 6
Bdy07	144.0000	SID	Body Diameter 7

- 11 Press OK to exit the Model Parameters dialog box. Save the part. The part updates to reflect any dimension changes.
If desired, change your view to isometric, and your visual style to conceptual, to see how the part is progressing.
- 12 Change the Autolayout location to the center of the Rim circular profile. This ensures that the structure is inserted properly into your drawing. Select Layout Data, right-click and then click Select Placement Point. The command line prompts you to Select a Placement Point.
- 13 Use your node OSNAP to select the point at the center of the Rim work plane circular profile. A small, cyan marker is displayed at that location. This marks the structure insertion point.
- 14 Save the part.

To continue this tutorial, go to [Exercise 4: Verifying the New Part](#) (page 673).

Exercise 4: Verifying the New Part

In this exercise, you will verify that the new part reacts as expected in a drawing by opening a drawing, regenerating the structure catalog, and accessing the new part from a Part List.

For more information, see the AutoCAD Civil 3D Help topic *Understanding Part Builder*.

This exercise continues from [Exercise 3: Matching Offsets and Dimensions to Parameters](#) (page 669).

- 1 At this point, it is important to determine how the new part reacts in a drawing situation. Exit the Part Builder utility by clicking the small X in the upper right corner of the Part Browser. (The Part Browser is the left pane portion of the Part Builder application window.) If you are prompted to save the part, click Yes. Part Builder closes.
- 2 Open the tutorial drawing called *Part Builder-1a.dwg*, and enter PartCatalogRegen in the command line. Enter S to indicate you want to regenerate the structure catalog. Press Enter. Click OK, and then press ESC to exit the PARTCATALOGREGEN command. A drawing opens with a sample surface, and the part catalog regenerates.
- 3 Create a new Parts List called "Test Parts List". The Parts List dialog box is displayed.

- 4 On the Structures tab, click Add Part Family. The Add Part Family dialog box is displayed.
- 5 Click your part, and then click OK. An entry is displayed on the Structures tab for the manhole.
- 6 Right-click your part and then click Add Part Size. The Part Size Creator dialog box is displayed. This dialog box lists all of the parameters as constants right now.

NOTE Do a quick visual check on the Part Size Creator dialog box to verify that all values are nonzero. If any of the properties are displayed in the Part Size Creator dialog box as zero, the part will **not** insert into the drawing properly.

- 7 Now add a few pipes to your Test Parts List. Exit the Parts List dialog box. A new Parts List is created.
- 8 Create a pipe network by layout that contains approximately three structures and two pipes.
- 9 Observe how your structures are displayed in plan (2D) views and in 3D view (Object Viewer).

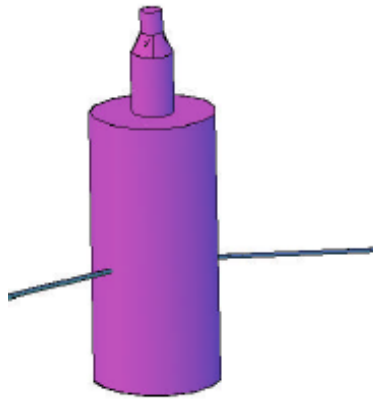

- 10 Make an alignment from network parts, and a corresponding profile view. Note how your structures respond to edits, adjustments, and changes of pipe inverts.

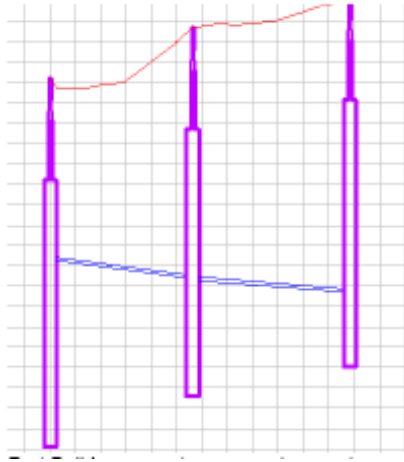

- 11 Click Home tab ► Create Design panel ▾ Part Builder . Select Manhole 206 Type A, and then click Modify Part Sizes. Part Builder opens to your custom part.
- 12 Add some variables to the Cone Height (SCH), Riser 1 Height (SRZ1), and Barrel Height (SBH) to make it easier to edit your structure after it has been inserted into the drawing. Right-click Size Parameters and then click Edit Configuration. The Edit Part Sizes dialog box is displayed.
- 13 Under SCH, SRZ1 and SBH, change the Data Storage from Constant to List. Each parameter now accepts additional values.
- 14 Click Values from the drop-down list at the top of the Edit Part Sizes dialog box. The Edit Part Sizes dialog box switches to Values mode.
- 15 Move your cursor to become active in the SCH column, and then click the Edit button from the Edit Part Sizes dialog box toolbar. The Edit Values dialog box is displayed.
- 16 Click Add to add the following values: 0, 6, 12, 18. Click OK to exit the dialog box. A list of values is now be available for SCH.
- 17 Repeat Steps 16 and 17 for SRZ1 and SBH, adding the following values to each list:
 - SRZ1 = 12, 24, 36, 48, 60
 - SBH = 100, 120, 140, 180

Click OK to exit the Edit Part Sizes dialog box. Lists of values are now available for SRZ1 and SBH.

18 Save your part.

Additional customizations can be made to the geometry of a manhole such as this one using the principles learned in the vault structure tutorial exercise, as well as other part building exercises.

19 Exit the Part Builder utility, click the small X in the upper right corner of the Part Browser. (The Part Browser is the left pane portion of the Part Builder application window.) If you are prompted to save the part, click Yes. Part Builder closes.

You can open *Part Builder-1.dwg* in the [tutorial drawings folder](#) (page 819) to see what this finished part looks like in a drawing.

Tutorial: Creating a Drop Inlet Manhole Structure

This tutorial demonstrates how to use Part Builder to create a drop inlet manhole structure. It will go through the steps to define the new part in the structure catalog, define the manhole geometry, create profiles, and then establish parameters to control the sizing and dimensions of the manhole.

For more information, see the AutoCAD Civil 3D Help topic *Understanding Part Builder*.

Exercise 1: Defining the New Part in the Structure Catalog



In this exercise, you will begin creating a drop inlet manhole structure in Part Builder by creating a new part chapter, and a new part family within the Structure catalog. You will also configure work planes in the Part Builder parametric modeling environment so that you can proceed with modeling the part in the later exercises.

This exercise uses a different process than the process that was used in the previous tutorial.

Because you will work in the Part Builder environment, you do not need to have a drawing open to begin this exercise. However, the AutoCAD Civil 3D [tutorial drawings folder](#) (page 819) includes a drawing that contains the completed part—in this case, a manhole structure with a drop inlet. If desired,

before or after completing this exercise, you can open the *Part Builder-2.dwg* file to see what this finished part looks like.

For more information, see the AutoCAD Civil 3D Help topic *Understanding Part Builder*.

- 1 Click Home tab ► Create Design ► panel  ► Part Builder .
- 2 In the Getting Started – Catalog Screen dialog box, in the Part Catalog list, select Structure.
- 3 Click the US Imperial Structure Catalog folder, and then click New Chapter. Enter Custom for name, and then click OK.
A new Chapter is created for custom structures.
- 4 Select the Custom folder, and then click New Parametric Part.
The New Part dialog box is displayed.
- 5 For Name, enter “NO 233a”. Click in the Description field, and add “Outside Drop Connection” to the default Description, and then click OK.
The Part Builder parametric modeling environment is opened.
- 6 Expand Part Configuration and change the following:
 - Undefined Part Type: change this to Junction Structure
 - Undefined: change this to Manhole (do this by double-clicking and then entering “Manhole” into this field)
 - Undefined Bounded Shape: change this to CylinderThe Part is configured as a cylinder shape with the properties of a junction structure.
- 7 Expand Modeling, right-click Work Planes, and then click Add Work Plane.
The Create Work Plane dialog box is displayed.
- 8 Click Top, enter “Rim” for Name, and then click OK.
A top work plane is created which represents the rim elevation of the structure.
- 9 Expand Work Planes, right-click Rim ► Add Geometry ► Point.
You are prompted to pick a point.
- 10 Click a point near the center of the yellow rectangle, and then press ESC.

A point is created on the Rim work plane near the center. This is a reference point to begin the construction of the part.

- 11** Right-click Work Planes and then click Add Work Plane.
The Create Work Plane dialog box is displayed.
- 12** Click Right, enter “Vertical Axis” for Name, and then click OK.
The Right side Vertical Axis work plane is created.
- 13** Click Save Part Family. Click Yes.
Stay in the Part Builder environment for the next exercise. The part is validated and saved. Depending on the part type, and on the Bounding Shape selected, certain Model Parameters and Size Parameters are automatically added to the part definition.

To continue this tutorial, go to [Exercise 2: Defining the Manhole Geometry](#) (page 678).

Exercise 2: Defining the Manhole Geometry

In this exercise, you will define the geometry of the drop inlet manhole by creating a simple schematic of the structure profile. You will build this portion with dimensions that can be modified from within AutoCAD Civil 3D when the part is in use.

For more information, see the AutoCAD Civil 3D Help topic *Understanding Part Builder*.

This exercise continues from [Exercise 1: Defining the New Part in the Structure Catalog](#) (page 676).

- 1** Expand Modeling ► Work Planes, right-click Vertical Axis ► Set View.
The current view and UCS is set to match the work plane.
- 2** Right-click Vertical Axis, and then click Add Geometry ► Line.
Create a line with 5 segments on the work plane. Begin by snapping to the node of the reference point on the Rim work plane and Use Ortho to make it easier to draw a straight line. Make the segments about 24 units long. A line geometry object is shown in the drawing. This line represents the vertical axis of the manhole. Each segment represents a component of the structure. Starting from the top, the segments represent the frame, the cone, and the last 3 segments represent the barrel. You will use the extra vertices to place the incoming Dip Tee and the Drop 90° Elbow in the next steps.



- 3 Use the Add Geometry ► Line and Add Geometry ► Arc to draw the schematic of the drop assembly. Don't worry about making the parts perfectly meet. You will use constraints to make the geometry match up properly. Make the two horizontal lines that connect to the vertical line about 36 units long. Next you will establish some constraints to keep the components of the profile in the correct location relative to one another.

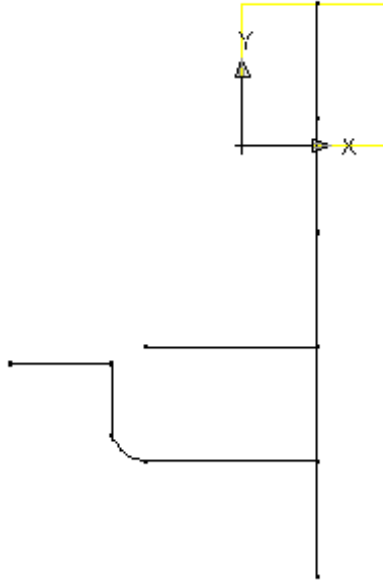

- 4 Right-click Vertical Axis ► Add Constraints ► Parallel. Select the bottom line segment of the manhole centerline, and then click the segment directly above it. The bottom two segments are now constrained such that they are parallel to each other.
- 5 Repeat the process, working your way up the centerline, constraining adjacent line segments to Parallel. All segments representing the centerline of the structure are constrained to be parallel to one another.
- 6 Right-click Vertical Axis ► Add Constraints ► Perpendicular. Select the bottom segment of the structure centerline and the lower horizontal line.
- 7 Repeat for the upper horizontal line. The lower and upper horizontal components of the drop pipe are constrained to be perpendicular to the structure centerline.
- 8 Right-click Vertical Axis ► Add Constraints ► Parallel. Select the bottom line segment of the manhole centerline and then click the vertical segment of the drop pipe. The vertical drop pipe is constrained to be parallel to the structure centerline.
- 9 Right-click Vertical Axis ► Add Constraints ► Coincident. Click the point at the top of the vertical drop pipe, and then the left end of the

upper horizontal line. This positions the rectangle so that its center is located at the fixed point.

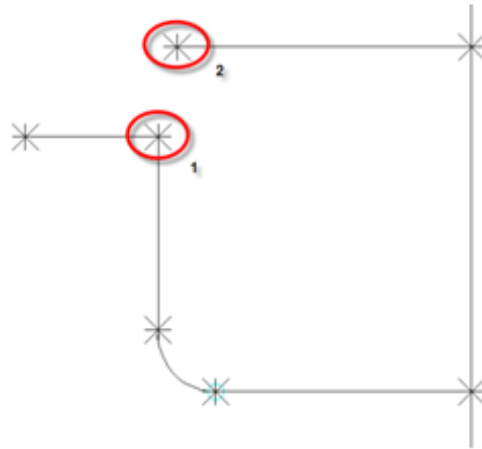

- 10 Right-click Vertical Axis ► Add Constraints ► Parallel. Select the right upper horizontal segment, and then the left upper horizontal segment. The two upper segments are constrained to parallel.

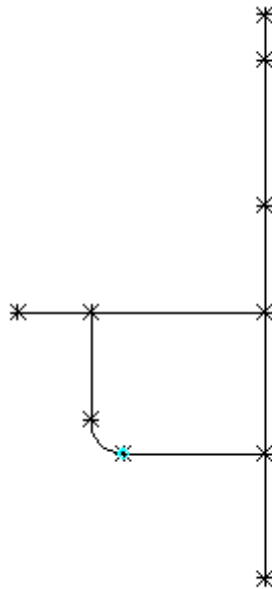

- 11 Right-click Vertical Axis ► Add Constraints ► Tangent. Select the lower horizontal line, and then the arc. Repeat for the arc and the vertical segment of the drop pipe. The drop pipe bend arc is constrained to be tangent with the horizontal and vertical segments of the pipe.

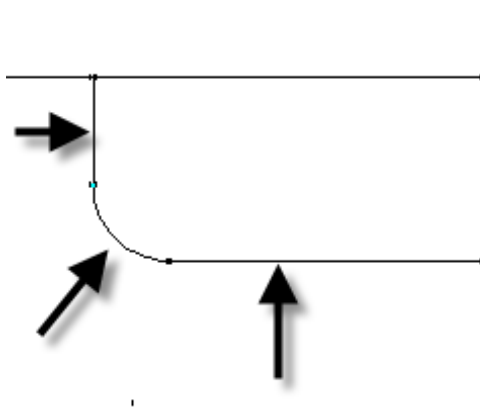

- 12 Right-click Vertical Axis ► Add Dimension ► Distance. Click the bottom and then top points at the ends of the top segment of the centerline. Click a point to set the location of the dimension. A dimension named LenA1 is created for the line segment representing the frame height.

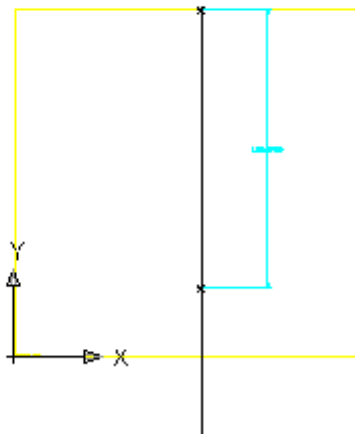

- 13 Repeat these steps for each segment of the centerline, starting at the top and ending at the bottom segment. Dimensions named LenA2 through LenA5 are created for the centerline of the structure.

NOTE For this exercise, make sure you dimension the segments in the order shown in the following illustration.

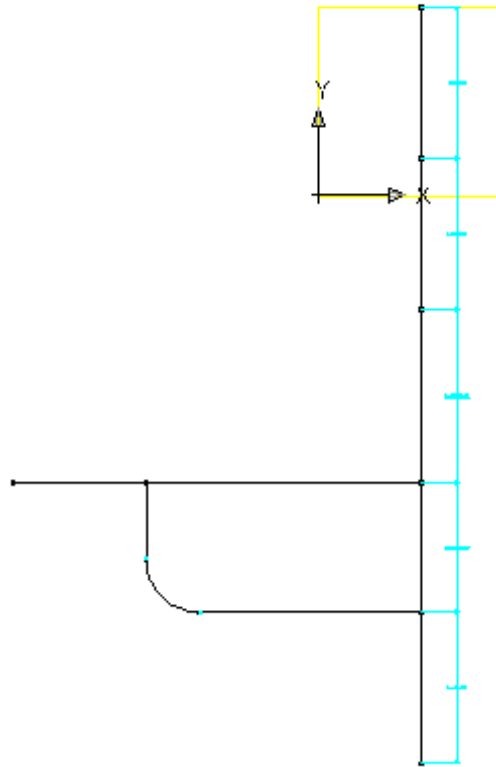

- 14 Add a Distance dimension to the lower horizontal line by picking the points at each end. This represents the distance from the structure centerline to the start of the elbow. This is used to ensure that the drop stays on the outside of the structure. LenA6 is created.

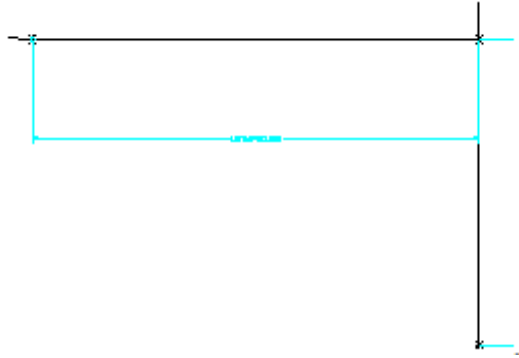

- 15 Right-click Vertical Axis ► Add Dimension ► Diameter. Select the arc that represents the elbow. Click a point to set the location of the dimension. BdyD1 is added to the arc.

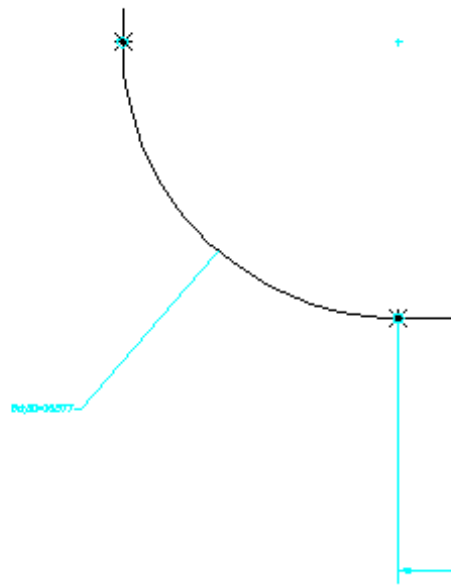

- 16 Add one final length dimension to the left upper horizontal line segment. LenA7 is added.

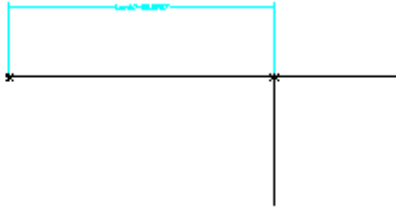

- 17** Click Save Part Family. The part is saved.
 Next you will add Profiles that represent the diameters of the frame, top of cone, barrel, and drop pipe.
 First, you'll create the profile for the frame diameter.
- 18** Right-click Vertical Axis ► Add Profile ► Circular. Click an open area near the top right of the vertical axis to define the center and then click again about 12 units away to define the diameter. A circle profile is drawn.

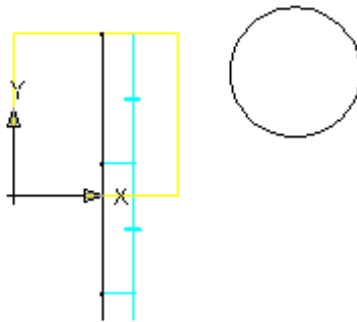

- 19** Right-click Vertical Axis ► Add Dimension ► Diameter. Click the circle drawn in the previous step. Click a point to set the location of the dimension. BdyD2 is created for the frame diameter.

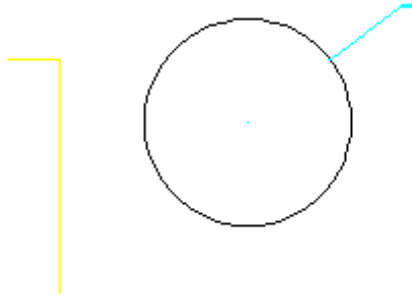

- 20 Expand Vertical Axis. Right-click Circular Profile ► Rename. Enter “Frame Cylinder Diameter”. This will make it easier to work with this shape later.
- 21 Next, repeat the previous two steps to create and dimension the top of cone profile with a radius of about 18 units, and the barrel profile with a radius of about 24 units. The top of cone profile is drawn and dimensioned with BdyD3. The barrel diameter profile is drawn and dimensioned with BdyD4.

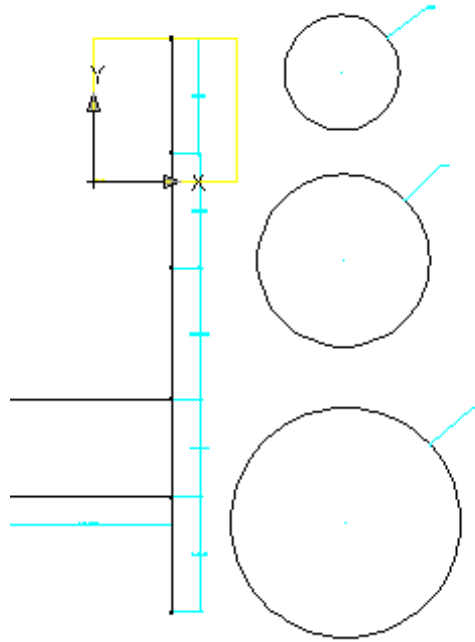

22 Next, create and dimension the drop pipe profile. Right-click Vertical Axis ► Add Profile ► Circular. Click an open area to the left of the upper end of the vertical axis to define the center and then click again about 6 units away to define the diameter.

23 Add a diameter dimension to the pipe profile. The pipe profile is created and dimensioned with BdyD5.

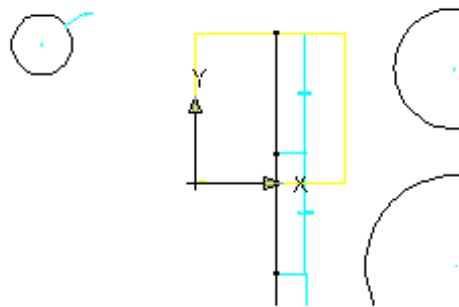

24 Rename the three Circular Profiles to Cone Top Diameter, Barrel Cylinder Diameter, and Drop Pipe Diameter. Renaming the profiles will make them easier to work with later.

25 Click Save Part Family.

The next exercise continues working on this part.

To continue this tutorial, go to [Exercise 3: Creating Profiles and Establishing Parameters](#) (page 688).

Exercise 3: Creating Profiles and Establishing Parameters

In this exercise, you will extrude the part profiles to create the 3D model. You will then establish the model parameters to control the sizing and dimensions of the manhole.

For more information, see the AutoCAD Civil 3D Help topic *Understanding Part Builder*.

This exercise continues from [Exercise 2: Defining the Manhole Geometry](#) (page 678).

- 1** Right-click Modifiers ► Add Path. When prompted for path, select the top line segment (the segment dimensioned LenA1), then select the Frame Cylinder Diameter profile (the circle dimensioned BdyD2) for the start profile, and select it again for the end profile. The Frame Cylinder Diameter profile is applied along the path (length) of the top line segment.

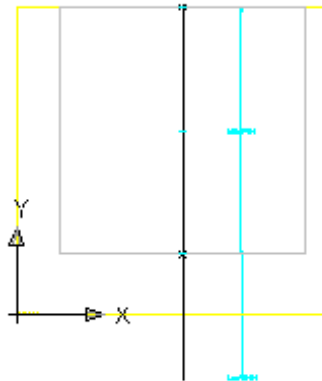

- 2** Change the view to SE Isometric to get a better view of the Path. Change the view back to Right.

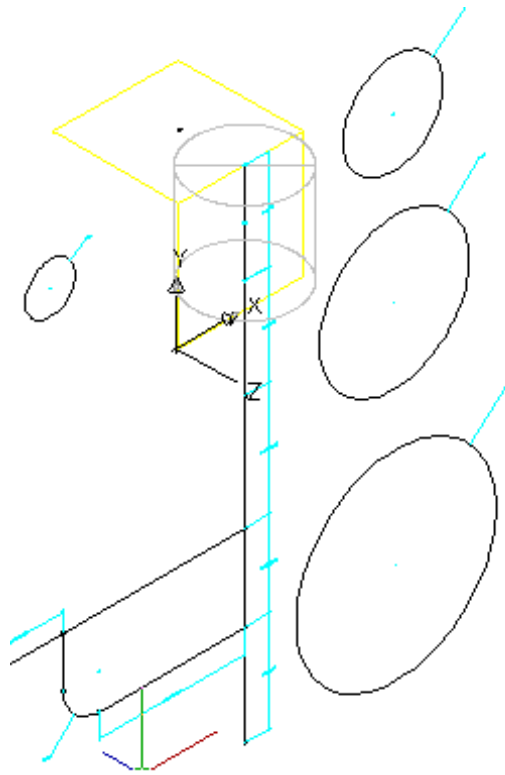

- 3 Repeat the Add Path command for the cone segment. For the start profile, select the Cone Top Diameter profile (dimensioned with BdyD3). For the end profile, select the Barrel Cylinder Diameter profile (dimensioned with BdyD4).

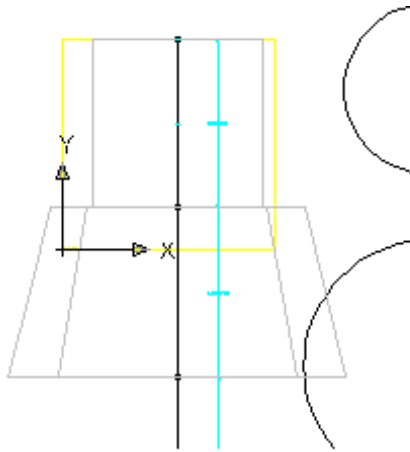

- 4 Repeat the Add Path command for the remaining three line segments. Use the Barrel Cylinder Diameter profile for both the start and end profiles for each of the three segments. Change your view to SE Isometric to see the part in 3D. Change view back to Right.

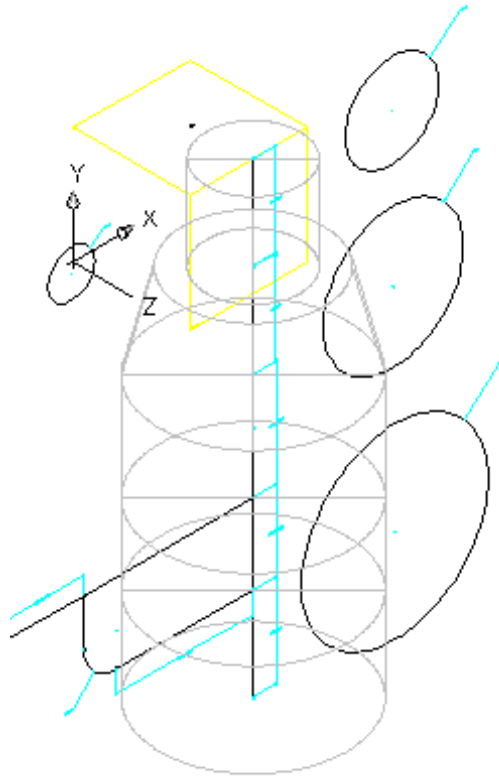

- 5 Next, you'll add paths for the drop pipe assembly. Right-click Modifiers
▶ Add Path. Select the lower horizontal segment for the path and the Drop Pipe Diameter profile for the start and end profiles.

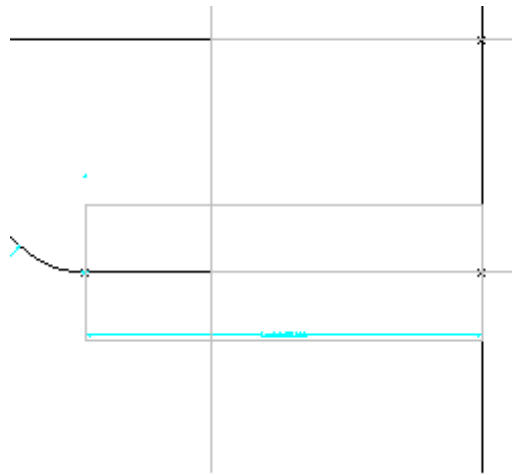

- 6 Add Path for the curved elbow. When the Enter Number of Path Segments dialog box is displayed, verify that “Do not segment path” is checked, and then click OK. Then add the path modifier for the vertical segment of the drop pipe. Use the Drop Pipe Diameter profile.

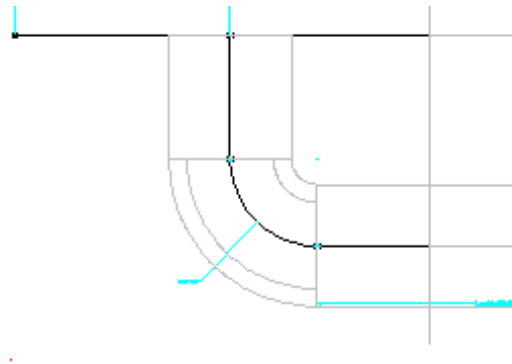

- 7 Finish the drop pipe assembly by adding paths for the upper segments. Start with the right upper segment. Switch to SE isometric view.

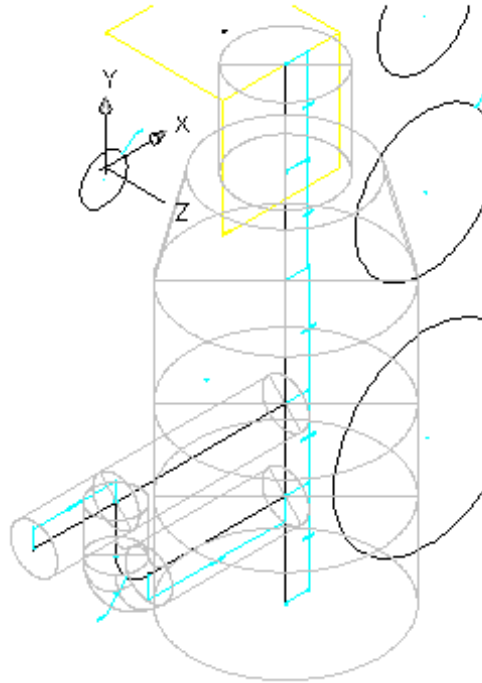

8 Switch back to Right view.

Next, you will merge the structure components with the drop pipe assembly components. Right-click Modifiers ► Boolean Add. When prompted to select objects, select the bottom two barrel segments, and the lower horizontal pipe segment, and then press Enter. The parts are merged.

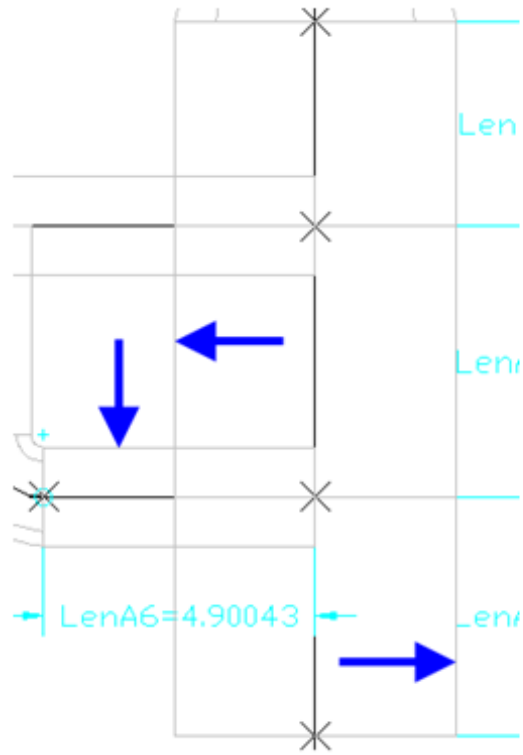
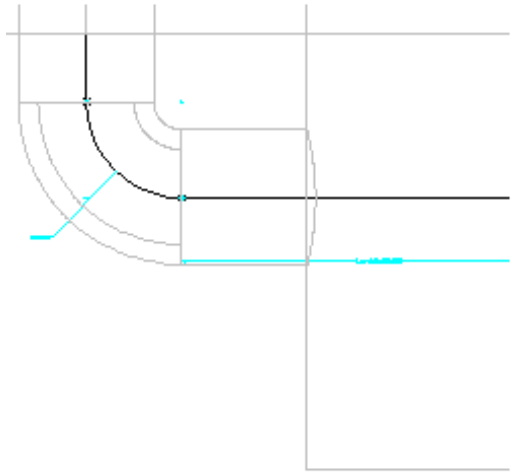

- 9 Right-click Modifiers ► Boolean Add. When prompted to select objects, select the top two barrel segments, and the upper two horizontal pipe segments, and then press Enter.

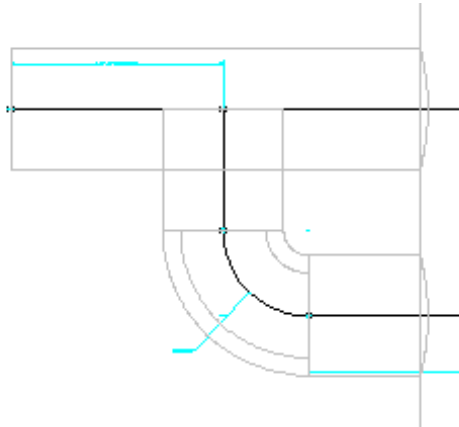

- 10 Right-click Modifiers ► Boolean Add. When prompted to select objects, select the upper horizontal pipe segment, and the vertical pipe segment, and then press Enter.

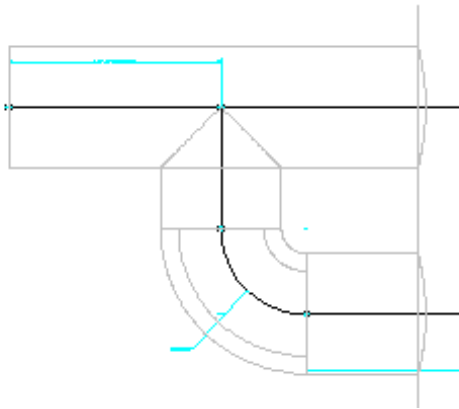

- 11 Switch the view to SE Isometric.

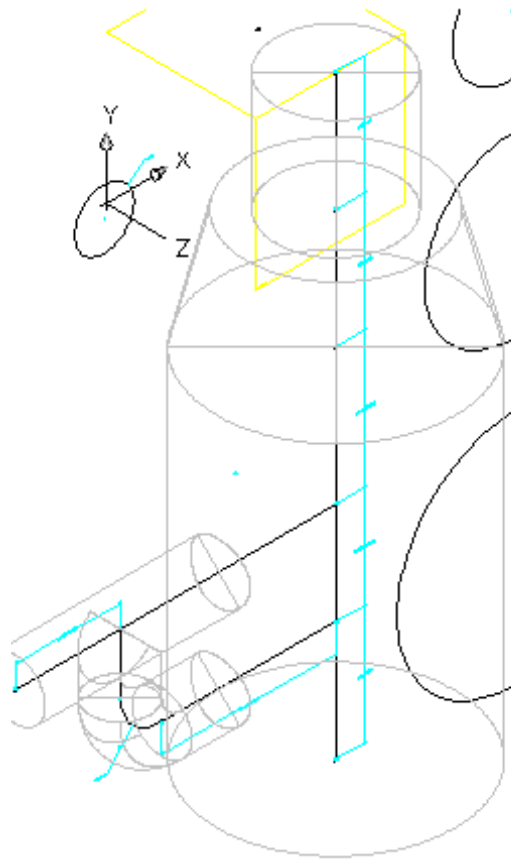

12 Next you will set the placement point for the part.

Add new Top workplane; Add Point reference; Select placement point on Top workplane Expand AutoLayout Data. Right-click Layout Data, and then click Set Placement Point. Use the node object snap to click the top point on the vertical axis. This is the point at which the part is inserted into the drawing (insertion point).

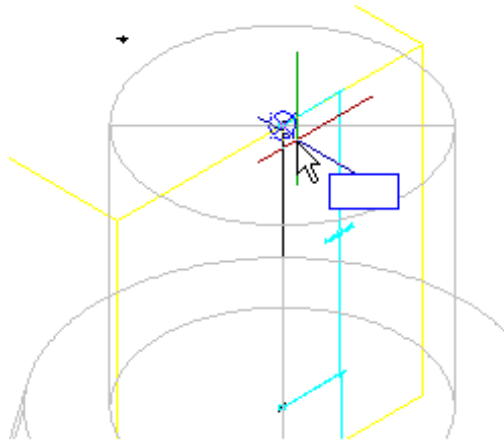

- 13 Save the part. Click Save Part Family.
- 14 Right-click Size Parameters ► Add ► Edit Configuration.
- 15 Click New. Add the following Parameters clicking New for each:
 - Barrel Height
 - Frame Height (SFH)
 - Frame Diameter (SFD)
 - Cone Height (SCH)
 - Inner Structure Diameter (SID)
 - Barrel Pipe Clearance (SBPC)Click OK when all of the parameters have been added.
- 16 Click Save Part Family. Right-click Model Parameters, and then click Edit. Double-click in the Equation column next to each of the following, and set the Equation for each parameters as shown below:
 - FTh to 6
 - WTh to 4
 - SBH to 74
 - FTh to 6
 - SBPC to 3

- SBSD to 48
- SBSH to 108
- SCH to 24
- SFD to 24
- SFH to 4
- SID to 48
- SRS to 102
- SVPC to 36
- WTh to 4

Saving the part causes the Model Parameters to update, including the new Size Parameters.

- 17 Right-click Size Parameters, and then click Edit Configuration. The Edit Part Size dialog box is displayed.
- 18 Locate the SRS column, click Constant, and change it to Range. The SRS parameter is now formatted as a range of values. Click the drop-down arrow button next to Parameter Configuration, and select Values. The view is changed to show the value of each parameter. Click the cell in the SRS column, and then click the Edit button on the Edit Part Sizes dialog box toolbar. The Edit Values dialog box is displayed. Set the Minimum to 36, the Maximum to 12000, the Default to 120, and then click OK.
- 19 Right-click Model Parameters, and then click Edit. Edit the Equations and Descriptions for the BdyD# parameters as shown in the following table:

BdyD1	12	Elbow Bend Diameter
BdyD2	SFD	Frame Cylinder Diameter
BdyD3	$SFD+(2*Wth)$	Cone Top Diameter
BdyD4	$SID+(2*Wth)$	Barrel Cylinder Diameter
BdyD5	12	Incoming Pipe Diameter

20 Make the following additional edits:

SBH	SRS-SFH-SCH
SBPC	3.0
SBSD	SID+(2*Wth)
SBSH	SRS+FTh

21 Edit the Equations and Descriptions for the LenA# parameters as shown in the following table:

LenA1	SFH	Frame Cylinder Height
LenA2	SCH	Cone Cylinder Height
LenA3	SVPC-SFH-SCH+(BdyD5/2)	Top Pipe CL
LenA4	SRS+FTh-SFH-SCH-LenA3-LenA5	Top Pipe CL to Bottom Pipe CL
LenA5	24	Bottom Pipe CL to Struct Bottom
LenA6	(SID/2)+WTh+(BdyD5/2+2)	CL Vert Pipe to Incoming Pipe

Click Close. Change to SE Isometric view and note the changes to the geometry of the structure.

22 Change the 4 circular profiles so they are not visible by right-clicking on each and then clicking Visible.

The circular profiles are no longer visible.

23 Repeat the previous step for all of the Dimensions.

24 Change view to SE Isometric and examine the part. It should look like the following image.

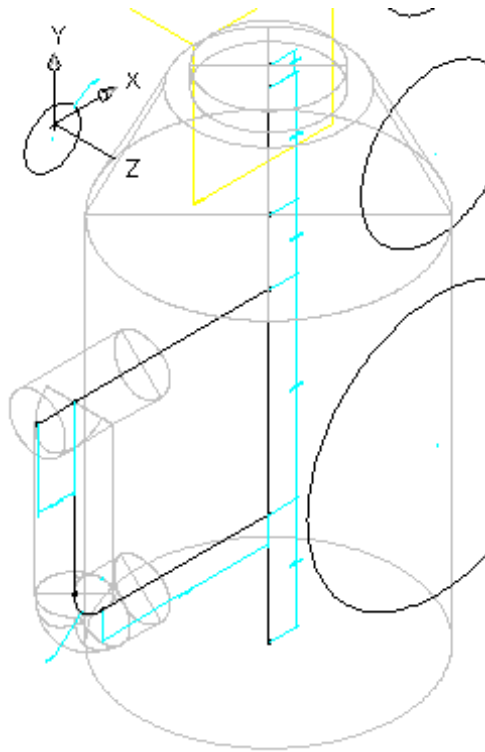

Click Save Part Family. Close out of the Part Builder Environment, and then re-open the Part.

To exit the Part Builder utility, click the small X in the upper right corner of the Part Browser. (The Part Browser is the left pane portion of the Part Builder application window.) If you are prompted to save the part, click Yes. Part Builder closes.

After all the changes that have been made, now is a good time to close out and re-open the part so that all of the data is freshly loaded into the part builder environment.

- 25 Right-click Size Parameters, and then click Edit Configuration.
- 26 Change the Data Storage type to List for the following parameters:
 - WTh
 - FTh
 - SFH

- SFD
 - SCH
 - SID
- 27 Click the drop-down arrow button next to Parameter Configuration, and select Values.
 - 28 Select the 4.000 in the WTh column, click the Edit button from the Edit Part Sizes dialog box toolbar, and add the following values: 4.0, 6.0. Click OK.
 - 29 Repeat the previous step for each of the following parameters:
 - FTh: 6.0, 8.0, 12.0
 - SFH: 4.0, 6.0, 8.0
 - SFD: 24.0, 36.0
 - SCH: 24.0, 36.0
 - SID: 48.0, 60.0, 72.0
 - 30 Click the drop-down arrow button next to Values, and select Calculations.
 - 31 Double click in the cell in the PrtSN to open the Calculation Assistant.
 - 32 Change the Precision to 0.
 - 33 Click in the text box, right after PrtD, and press the space bar.
 - 34 From the Insert Variable list, select FTh and then click Insert. The FTh variable is inserted into the Part size name.
 - 35 Enter “in Floor” after the FTh variable. (Exclude the quotation marks.)
 - 36 Repeat the previous steps, adding variables and text for SCH, SFD, SFH, SID, WTh. The complete string should look something like this:
PrtD FTh in Floor SCH in Cone Hgt SFD in Frame Dia SFH in Frame Hgt
SID in Barrel Dia WTh in Wall.
 - 37 Click Evaluate to see the resultant part name.
Note that the name is long and partially cut off on the right. Click the name and use your keyboard arrow keys to see the rest of the name. This is a required step to ensure that each part has a unique part name when added to the part list.

- 38 Click OK twice to close all dialog boxes.
- 39 Save the Part. Switch Visual Style to Conceptual. The part should look like the following:

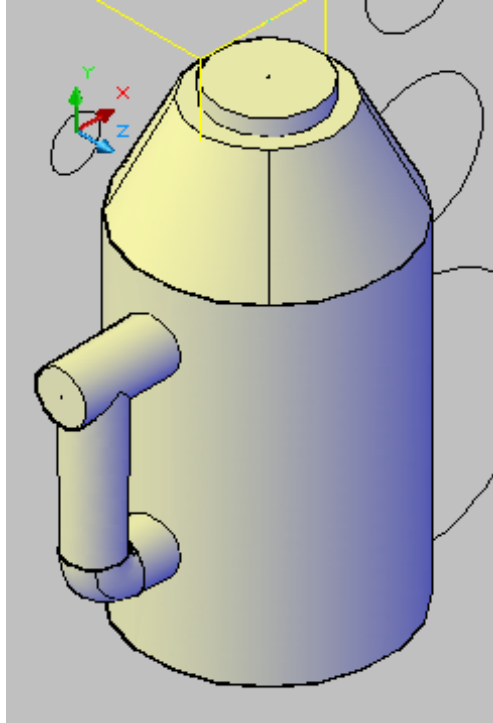

- 40 Right-click Model Parameters, and then click Edit.
- 41 Double click the Equation for SVPC and enter: $SFH+SCH+SBPC$. Change the Visual Style to 2D Wireframe. Right-click Vertical Axis ► Add Geometry ► Point Reference.
- 42 Click the point in the center of the Rim work plane.

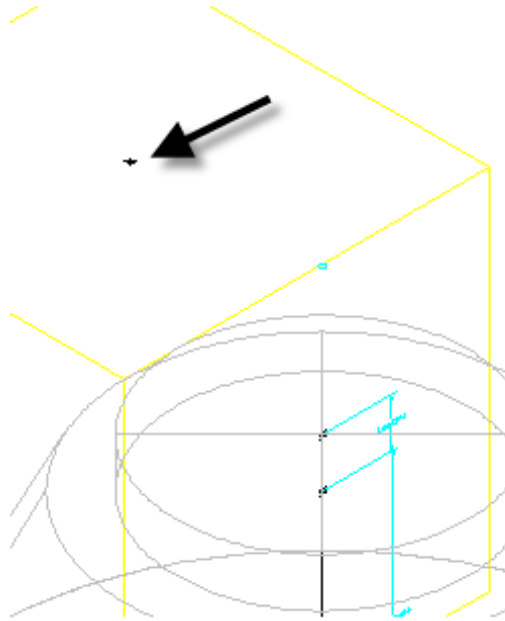

A reference point (green) is created where the two planes meet in line with the vertical axis of the structure.

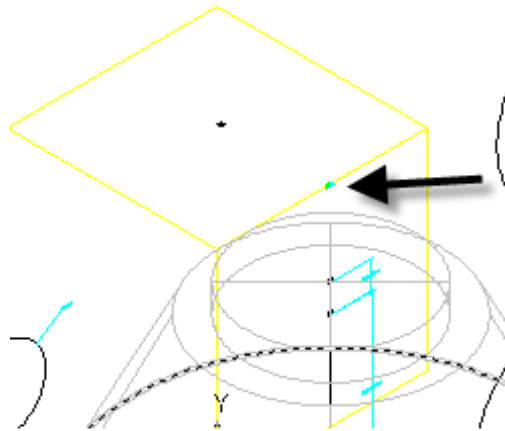

- 43 Right-click Vertical Axis ► Add Constraints ► Coincident. Click the top point of the vertical axis, then click the reference point created in the previous step. The entire structure moves upward so that the rim elevation matches the top work plane.

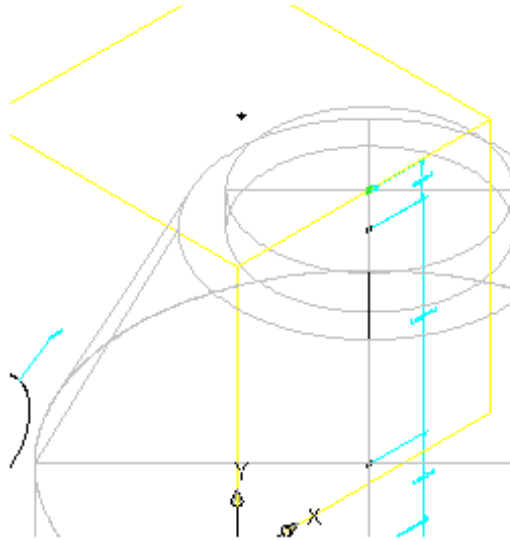

- 44 Click Generate Bitmap.
- 45 Click SE Isometric View.
- 46 Click OK. A bitmap image is generated. This is the image of the part that is displayed when viewing the part in the part catalog. It is not used not when viewing the part in a drawing.

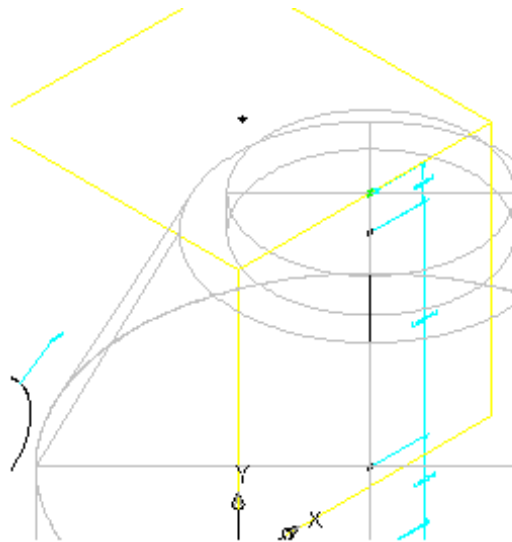

- 47 Click Save Part Family.
- 48 Exit the Part Builder utility by clicking the small X in the upper right corner of the Part Browser. (The Part Browser is the left pane portion of the Part Builder application window.) If you are prompted to save the part, click Yes. Part Builder closes.

You can open *Part Builder-2.dwg* in the [tutorial drawings folder](#) (page 819) to see what this finished part looks like in a drawing.

Tutorial: Creating a Vault Structure

This tutorial demonstrates how to use Part Builder to create a vault structure. It will go through the steps to define the new part in the structure catalog, define the manhole geometry, create profiles, and then establish parameters to control the sizing and dimensions of the vault.

For more information, see the AutoCAD Civil 3D Help topic *Understanding Part Builder*.

Exercise 1: Defining the New Part in the Structure Catalog



In this exercise, you will begin creating a vault structure in Part Builder by creating a new part chapter, and a new part family within the Structure catalog.

You will also configure work planes in the Part Builder parametric modeling environment so that you can proceed with modeling the part in the subsequent exercises.

Because you will work in the Part Builder environment, you do not need to have a drawing open to begin this exercise. However, in Exercise 5, Using the New Part, you will be instructed to open a drawing (*Part Builder-3a.dwg*) and use the part in a pipe network.

The AutoCAD Civil 3D [tutorial drawings folder](#) (page 819) includes a drawing that contains the completed part—in this case, a vault manhole structure. If desired, before or after completing this exercise, you can open the *Part Builder-3b.dwg* file to see what this finished part looks like.

For more information, see the AutoCAD Civil 3D Help topic *Understanding Part Builder*.

- 1 Click Home tab ► Create Design panel  Part Builder . The Getting Started - Catalog Screen dialog box is displayed.
- 2 Click the US Imperial Structures Folder, then click New Chapter. Enter Custom for name and then click OK. A new Chapter is created for custom structures.
- 3 Verify that the Custom Folder is selected, then click New Parametric Part. The New Part dialog box is displayed
- 4 For Name enter "Vault 5106-LA with Top 5106TL3- 332". Click in the box next to Description. The description matches the name by default. Click OK. The Part Builder environment is opened.
- 5 Expand Part Configuration and change the following:
 - Undefined Part Type: change this to Junction Structure
 - Undefined: change this to Rectangular Vault (do this by double-clicking and then entering "Rectangular Vault" into this field)
 - Undefined Bounded Shape: change this to Box

The Part is configured as a box shape with the properties of a junction structure.

- 6 Expand Modeling. Right-click Work Planes, and then click Add Work Plane. The Create Work Plane dialog box is displayed.
- 7 Click Top, and then click OK. The Top work plane is created.
- 8 Expand Work Planes. Right-click Top Plane and then click Rename. Change the name to Rim. This work plane will become the rim elevation of the new structure.
- 9 Click Save Part Family. Click Yes. Stay in the Part Builder environment for the next exercise. The part is validated and saved.

To continue this tutorial, go to [Exercise 2: Defining the Vault Top Section Geometry](#) (page 707).

Exercise 2: Defining the Vault Top Section Geometry

In this exercise, you will build the top portion of the vault. This is a rectangular frame with a rectangular opening. You will build this portion with dimensions that can be modified from within AutoCAD Civil 3D when the part is in use.

For more information, see the AutoCAD Civil 3D Help topic *Understanding Part Builder*.

This exercise continues from [Exercise 1: Defining the New Part in the Structure Catalog](#) (page 706).

- 1 Expand Modeling ► Work Planes, right-click Rim ► Set View. The current view and UCS is set to match the work plane.
- 2 Right-click Rim ► Add Profile ► Rectangular. Click two points to draw a rectangle in the drawing area. A rectangular profile object is shown in the drawing.
- 3 Expand Rim, right-click Rectangular Profile in the Content Builder window and then click Rename. Enter Frame Outer Edge as the name. This name makes it easier to identify the component.
- 4 Repeat these steps to create another rectangular profile within the first one. Name it Frame Opening.

Next you will establish some construction geometry and constraints to keep the opening positioned at the center of the box. Rectangular profiles representing the outer edge of the frame and the opening have been created.

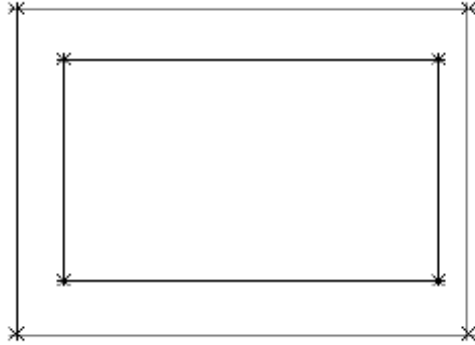

- 5 Right-click Rim ► Add Geometry ► Point. Click a location near the center of the rectangles. Press ESC. This becomes the center point of the structure.

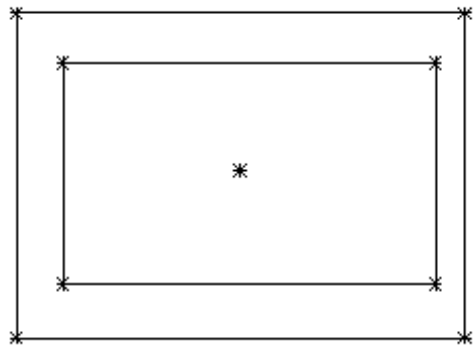

- 6 Expand the Geometry folder. Right-click Point 2D ► Rename. Enter Fixed Center for the name. This name makes it easier to identify the component.
- 7 Right-click Fixed Center ► Fixed. The point is now fixed. Constraints that include this point will not move the point.
- 8 Right-click Rim ► Add Constraints ► Equal Distance. Click the point at the top left corner of the outer rectangle, then the Fixed Center Point. For the second pair, click the point at the bottom right corner of the outer rectangle, and the Fixed Center Point.

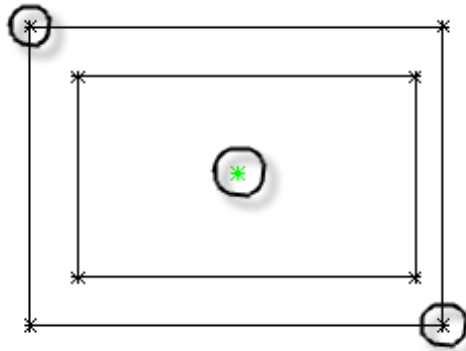

- 9 Repeat this step for the bottom left and upper right corners of the outer rectangle. This constrains the outer rectangle so that it is centered about the Fixed Center.
- 10 Repeat these steps for the four corners of the inner rectangle. Both rectangles are now centered about the fixed point.

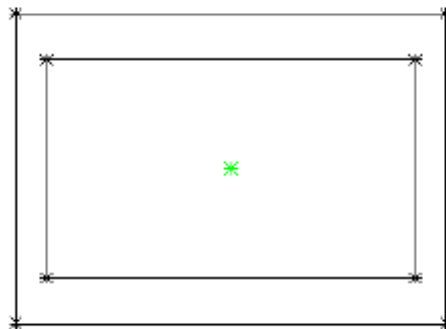

- 11 Right-click Rim ► Add Constraints ► Parallel. Click any line on the outer rectangle, then the line that is parallel to it on the inner rectangle. This constraint prevents the inner rectangle from rotating within the outer rectangle.

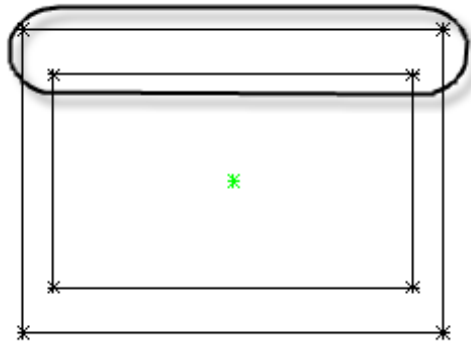

- 12** Right-click Rim ► Add Dimension ► Distance. Click two points at either end of the top side of the outer rectangle. Click a point to set the location of the dimension. A dimension named LenA1 is created for the long side of the outer edge of the frame.

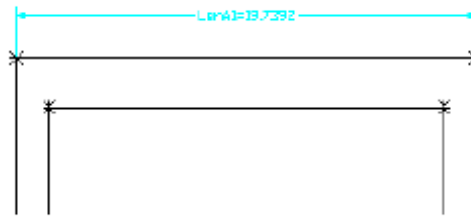

- 13** Repeat these steps for the right side of the outer rectangle. A dimension named LenA2 is created for the short side of the outer edge of the frame.

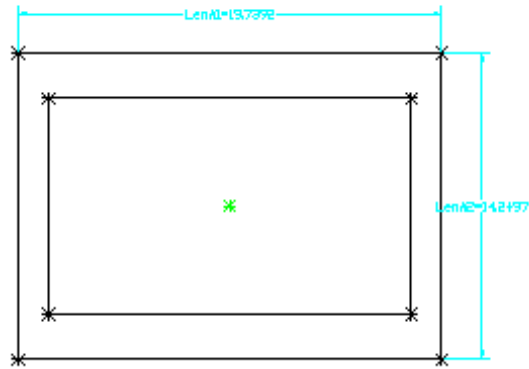

- 14 Repeat these steps for top and right sides of the opening, in that order. Reposition the dimensions as needed so that they are easy to read. LenA3 and LenA4 are created for the long side and short side of the opening, respectively.
- 15 Click View tab ► Views panel ► SW Isometric. This 3D view is better suited for the next steps.

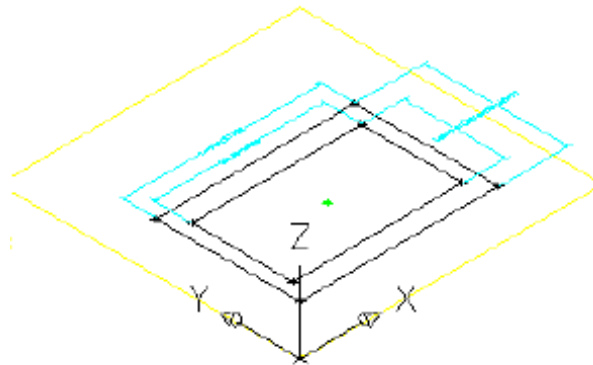

- 16 Right-click Modifiers ► Add Extrusion. Click the outer rectangle. The Extrusion Modifier dialog box is displayed.
- 17 Verify that Type is set to Blind. Enter 8 for Distance and check the box next to Flip. Click OK. An extrusion modifier is created for the outer rectangle.

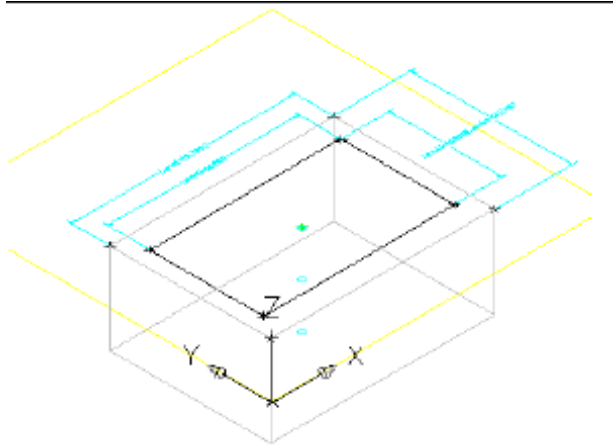

- 18** Repeat these steps to create an Extrusion modifier for the inner rectangle using a distance of 9. An extrusion modifier is created for the inner rectangle.

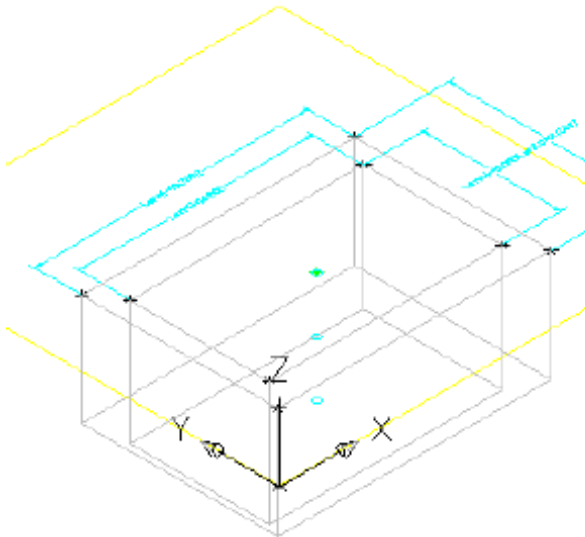

- 19** Right-click Model Dimensions ► Add Distance. Click one of the vertical edges of the outer box extrusion. Click a point to set the location of the dimension. LenB1 is created for the height of the frame section.

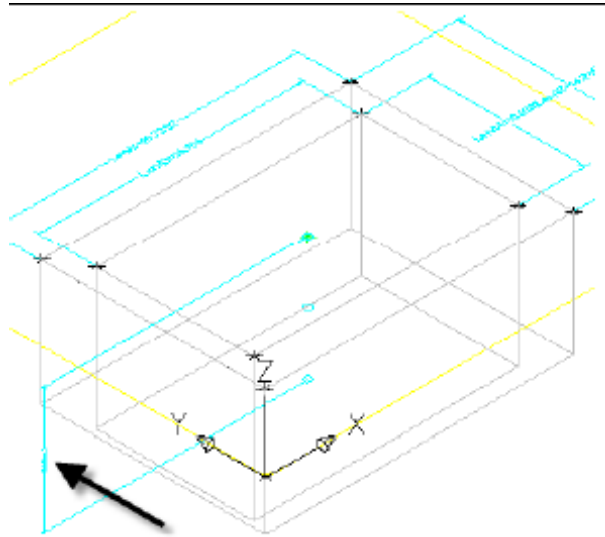

20 Repeat this step for the inner box extrusion. LenB2 is created for the height of the opening extrusion.

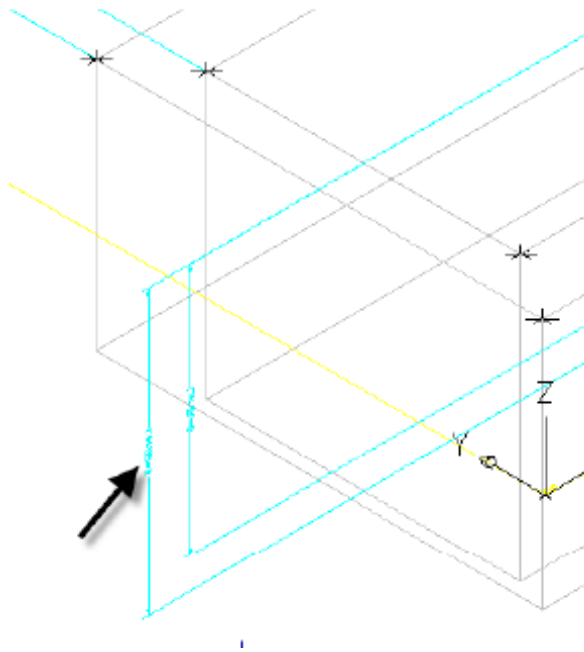

- 21 Expand Model Parameters, right-click Model Parameters, and then click Edit. The Model Parameters dialog box is displayed.
- 22 Click LenB2, then click Calculator. Click Variable, then select LenB1. Enter +1 after LenB1 and then click OK, then Close.
This ensures that the extrusion for the opening is always deeper than the thickness of the frame. You could also have double clicked the cell in the Equation column and entered in your own formula.
- 23 Right-click Modifiers ► Add Boolean Subtract. Click the outer box, then the inner box, and then press Enter. The inner box is subtracted from the outer box creating a third modifier which is the result of this action.

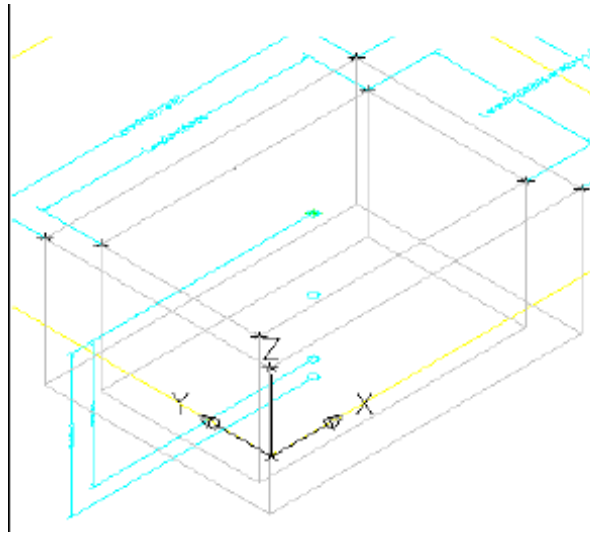

- 24 Expand Modifiers. Notice the three modifiers that have been created. The Extrusion modifiers have been set to invisible by default as a result of the Subtract command. Rename the modifier named Subtract to Frame.
- 25 Right-click Size Parameters and then click Edit Configuration. The Edit Part Sizes dialog box is displayed.
- 26 Scroll to the right until you see the SBSL (Structure Length) column. Click Constant in the SBSL column, and change it to list. Do the same for the SBSW (Structure Width) Column. These parameters can now be specified by a list of values, rather than by a single constant.
- 27 Click the drop-down arrow button next to Parameter Configuration, and select Values. Click the cell under SBSL, and then click the Edit button

from the Edit Part Sizes dialog box toolbar. The Edit Values dialog box is displayed.

- 28 Change the current value to 48. Then use the Add button to create values of 60, 72, 84, 96, 108, and 120. This makes it so that the Structure Length parameter can be adjusted in 12-inch increments.
- 29 Repeat this step for the SBSW column, creating values of 36, 48, 60, and 72.
- 30 Set the value of SBSL to 120 and the value of SBSW to 60. Click the Update Model button in the Edit Part Sizes dialog box toolbar. This updates the values under Model Parameters to match the Part Parameters.
- 31 Click OK. Right-click Model Parameters and then click Edit. Click LenA1, and then click Calculator.
- 32 Click Variable, and then click SBSL. Click OK, and then Close.
- 33 Repeat these steps for LenA2, equating it to SBSW. The model is updated to reflect the changes to the dimensions.

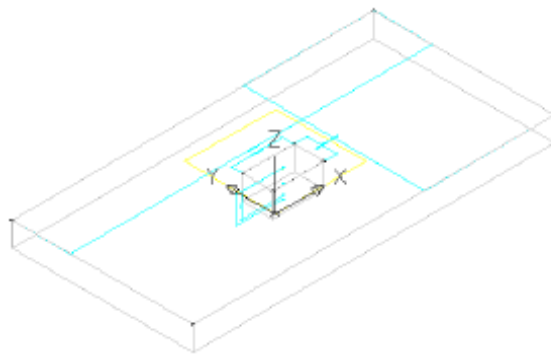

- 34 Right-click Size Parameters and then click Edit Configuration. Click New. The New Parameter dialog box is displayed.
- 35 Click Frame Length, and then click OK. Click New, then click Frame Width, OK. Two new parameters have been added: frame length (SFL) and frame width (SFW).
- 36 Scroll to the right until you see the SFL and SFW columns. Change Constant to List for each of these columns. Then change the view to Values.

- 37** Using the same procedure that was used for SBSL and SBSW, add values of 36, 48, 60, 72, 84, 96, and 108 for SFL. Add values of 24, 36, 48, and 60 for SFW.

These values are now controlled by lists that can ultimately be manipulated from within AutoCAD Civil 3D when the part is in use.

- 38** Click OK to close the Edit Part Sizes dialog box. Click Save Part Family. This saves the part as well as updates the Model Parameters to include the newly added Size Parameters.
- 39** Right-click Size Parameters and then click Edit Values. Set the following values:

■ SFL: 108

■ SFW: 48

Click the Update Model button in the Edit Part Sizes dialog box toolbar, and then click OK. This updates the Model Parameter values so that they match the Part Parameter values where applicable.

- 40** Expand Model Parameters, edit LenA3 and LenA4 to equate to SFL and SFW respectively. The model updates to reflect the changes to the dimensions.

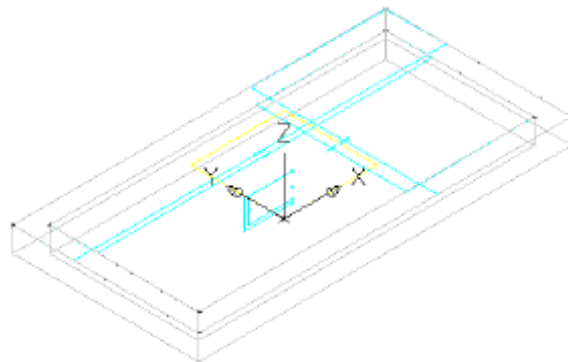

- 41** Click Save Part Family. Remain in the Part Builder environment for the next exercise.

To continue this tutorial, go to [Exercise 3: Defining the Vault Box Geometry](#) (page 717).

Exercise 3: Defining the Vault Box Geometry

In this exercise, you will build the box portion of the vault. You will use projection geometry and constraints to link the box to the frame so that a single set of dimensions can control both.

For more information, see the AutoCAD Civil 3D Help topic *Understanding Part Builder*.

This exercise continues from [Exercise 2: Defining the Vault Top Section Geometry](#) (page 707).

- 1 Continue from the previous exercise in the Part Builder environment. Click View tab ► Views panel ► SW Isometric. Next you will create a reference work plane at the bottom of the frame. This view makes it easier to perform the next few steps.

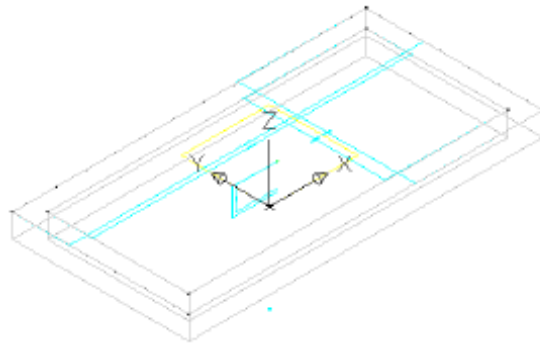

- 2 In the Content Builder window, right-click Work Planes, and then click Add Work Plane. The Create Work Plane dialog box is displayed.
- 3 Click Reference then enter Top of Box for Name. Click OK. You are prompted for a modifier.
- 4 When prompted for modifier, select the 3D frame object.

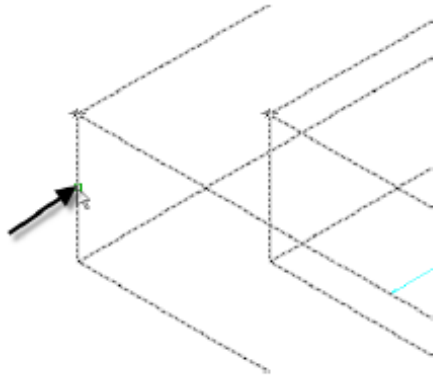

A new yellow rectangle is displayed representing the reference plane at the bottom of the frame (also top of box). This reference plane is attached to the modifier and moves if the frame thickness is adjusted.

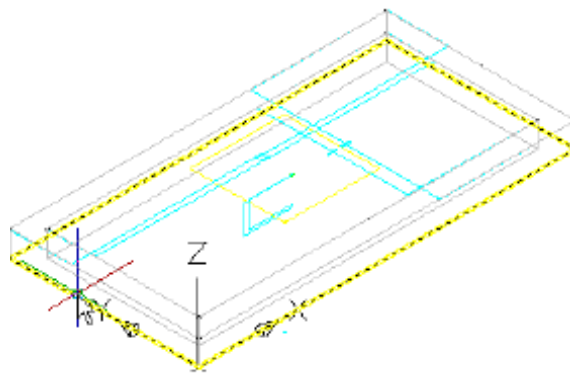

When prompted for the work plane, select the yellow rectangle at the top of the frame object (this represents the top plane).

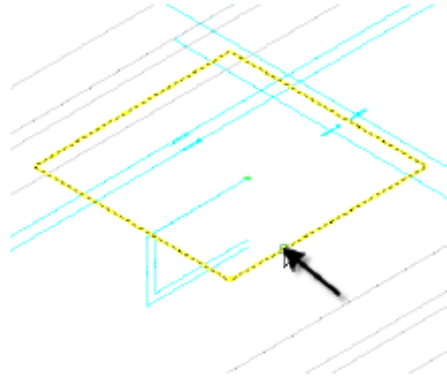

When prompted for the reference work plane, click along the lower edge of the frame object.

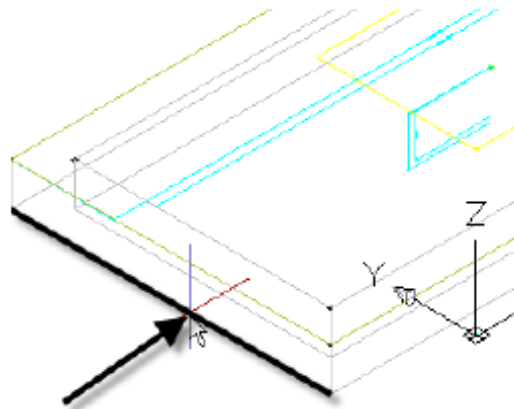

- 5 Right-click Top of Box and then click Set View. Next, click View tab ► Views panel ► SW Isometric. This sets the working plane to Top of Box and then returns the drawing to its original view.
- 6 Right-click Top of Box ► Add Geometry ► Projected Geometry. You are prompted for a modifier.
- 7 Click the 3D frame object. When prompted for the geometry to project, click one of the lower edges. The line highlights in red when the cursor

is in the correct position. Repeat this process for the three remaining lower edges.

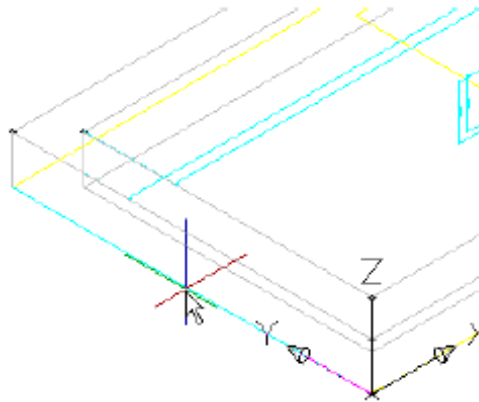

This creates geometry that is linked to the lower edge of the frame extrusion. This is a key relationship in building the box section below the frame so that it is aligned with the frame. The projected geometry is displayed in green.

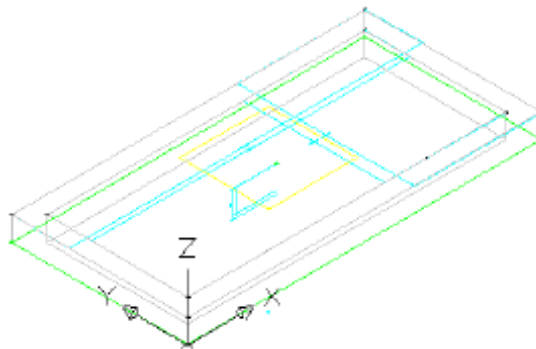

- 8 Set the visibility of all geometry and profiles in the Rim work plane to off. Right-click Top of Box and then click Set View. Objects in the Rim work plane are turned off so that you do not snap to them or use them inadvertently.
- 9 Right-click Top of Box ► Add Profile ► Rectangular. You are prompted for rectangle points.

- 10** Click two points to create a rectangle that is outside of the current geometry. In Content Builder, change the name Rectangular Profile to Outer Wall. A rectangular profile is drawn.

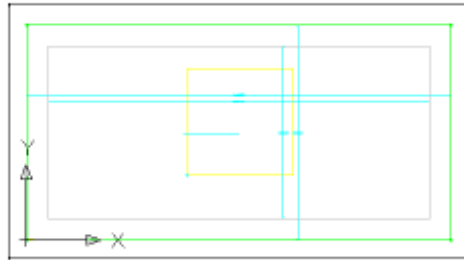

- 11** Draw a second rectangular profile within the first. Change its name to Inner Wall. There are now two rectangular profiles.

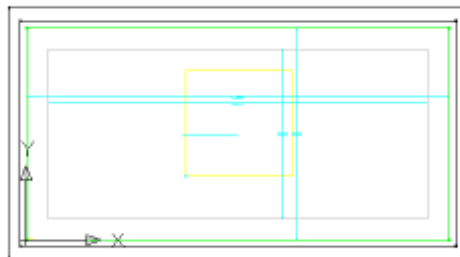

- 12** Right-click Top of Box ➤ Add Constraints ➤ Equal Distance. Click the left side of the outer rectangle, then the left side of the inner rectangle. Then click the top side of the outer rectangle and the top side of the inner rectangle. The distance between the outer wall and inner wall on the left side is set to always match the distance between the outer wall and inner wall on the top side.

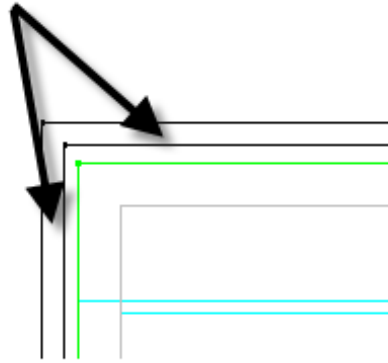

- 13 Repeat this procedure, first clicking the top pair of lines then clicking the right pair. Continue around the rectangle in a clockwise direction, finishing up by setting the right side equal to the bottom side.

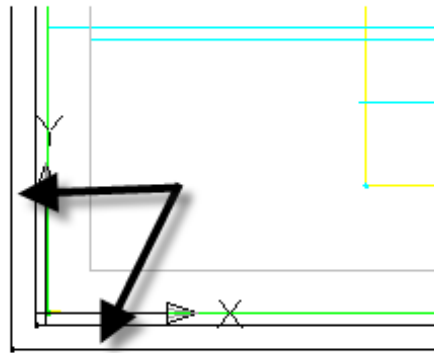

All sides are now equal. With these constraints in place, you can change the thickness of one side and the changes affect all sides.

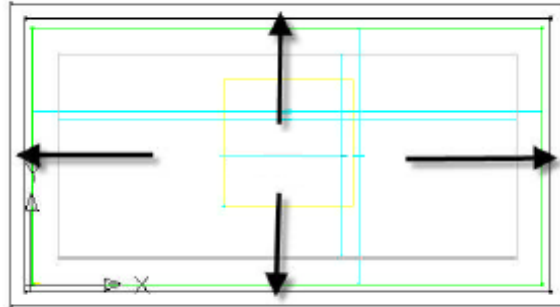

- 14 Right-click Top of Box ► Add Dimension ► Perpendicular Distance. Click a line on the inner rectangle then the corresponding parallel line on the outer rectangle. Click either of the lines once again to set a perpendicular reference object. Pick a point between the two lines for the dimension position and enter 4 for the dimension value. A new dimension named LenA5 is created. This single dimension sets the wall thickness of the box. Because of the equal distance constraints established in the step above, this dimension controls all four sides.

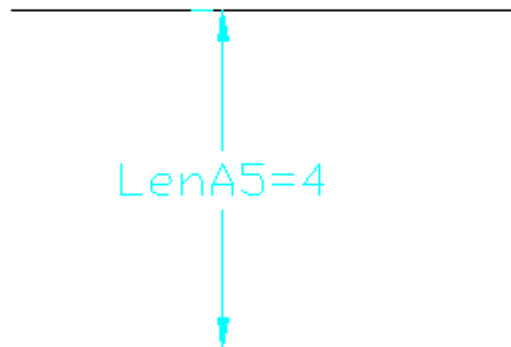

- 15 Right-click Top of Box ► Add Constraint ► Coincident. Click the black point at the top left corner of the outer box, then click the green projected point at the top left corner of the frame.

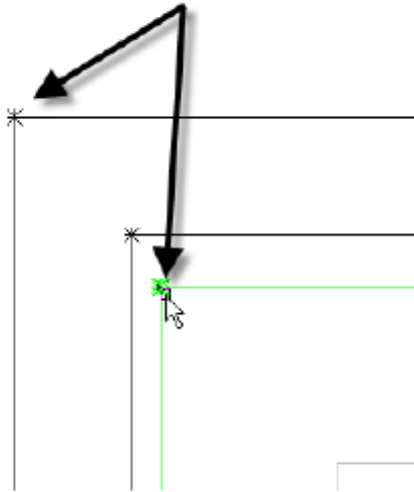

The black point is moved to be coincident with the green point. Because of constraints, the top and left sides of both rectangles are moved and the 4" distance between the inner and outer walls is maintained.

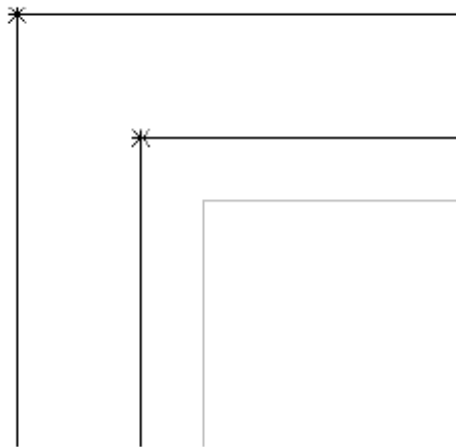

- 16 Repeat this procedure for all four corners. You may need to use Shift+Space to select the green point. The Top of Box geometry is linked to the green projected geometry, which is linked to the extrusion modifier projected

from the Rim work plane. With these relationships, the geometry of the entire vault can be controlled with a few parameters.

- 17 Right-click Model Parameter and then click Edit. Change the Equation for LenA5 to Wth. Change the value for Wth to 4. Wall thickness (Wth) is one of the size parameters that is built in to this part type.
- 18 Click View tab ► Views panel ► SW Isometric. Right-click Modifiers and then click Add Extrusion. You are prompted to select a profile.
- 19 Click the outer rectangle. Enter 48 for Distance and check the box next to Flip. Click OK.

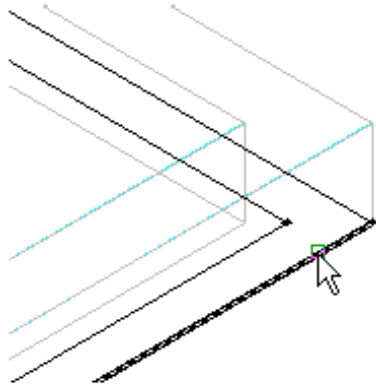

An extrusion is created that extends downward 48 inches.

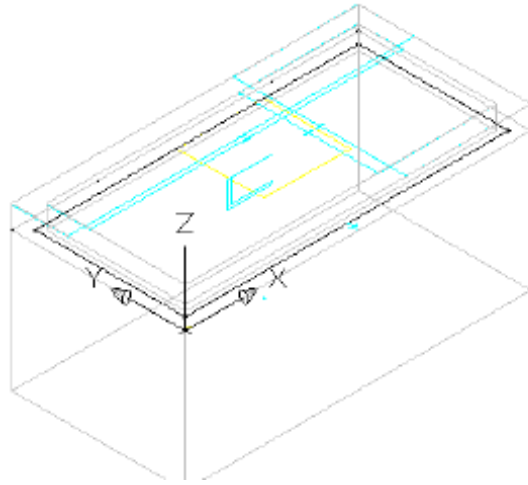

- 20** Change the name of the new extrusion modifier to Box Outside. Repeat these steps for the inner rectangle using a distance of 44 and a name of Box Inside.

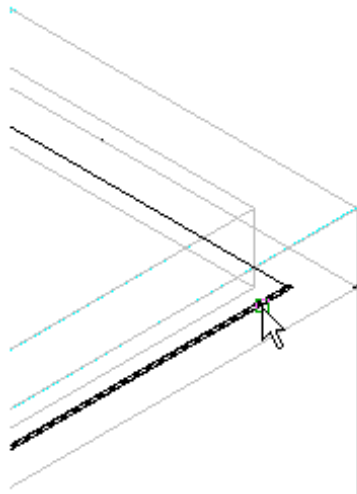

The inner extrusion stops 4 inches shy of the outer extrusion, creating a 4-inch thick floor.

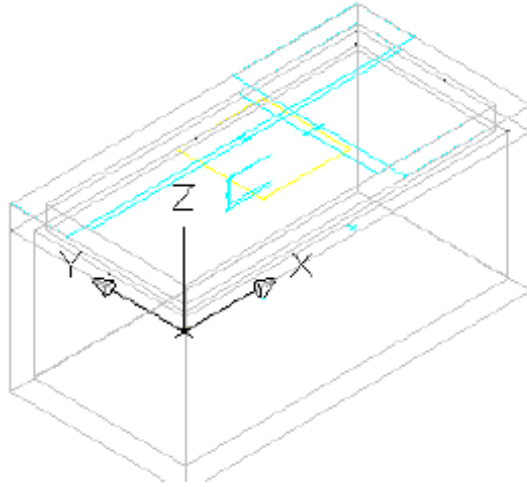

- 21 Right-click Modifiers and then click Add Boolean Subtract. Click the outer extrusion, then the inner extrusion. Press Enter. Name the new modifier Box.
- 22 Right-click Size Parameters and then click Edit Values. Change to the following values:
 - SBSL = 84
 - SBSW = 48
 - SFL = 72
 - SFW = 36

Click the Update Model button in the Edit Part Sizes dialog box toolbar, and then click OK. Note the change to the model. The model updates according to the size parameter changes.

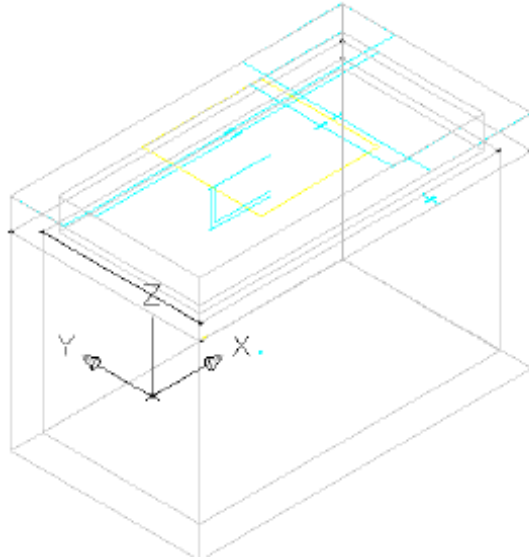

- 23 Click Save Part Family. Stay in the Part Builder environment for the next exercise.

To continue this tutorial, go to [Exercise 4: Finalizing the Part](#) (page 728).

Exercise 4: Finalizing the Part

In this exercise, you will add the final model and size parameters that will allow the part geometry to be modified in AutoCAD Civil 3D.

For more information, see the AutoCAD Civil 3D Help topic *Understanding Part Builder*.

This exercise continues from [Exercise 3: Defining the Vault Box Geometry](#) (page 717)

- 1 Continue from the previous exercise in the Part Builder environment. Click the View tab ► Views panel ► SW Isometric. Next you will link the Size Parameters that will be available in AutoCAD Civil 3D with the actual dimensions of the Top Section. This view makes it easier to perform the next few steps.

- 2 Right-click Size Parameters ► Edit Configuration. Click the New button at the top of the Edit Part Sizes dialog box. The New Parameter dialog box is displayed.
- 3 Click Frame Height, and then click OK. The Frame Height (SFH) parameter is added.
- 4 Scroll to the right until you see the SFH column. Click Constant in the SFH column and change it to List. Click the drop-down arrow button next to Parameter Configuration, and select Values. The values for each parameter are shown.
- 5 Click the value cell in the SFH column, and then click the Edit button. Add the values 8,12, and 16 to the list and then click OK. Set the value of SFH to 8. This parameter will now be available as three sizes in AutoCAD Civil 3D.
- 6 Click OK. Click Save Part Family. This updates the Model Parameters to include the Size Parameters.
- 7 Right-click Size Parameters and then click Edit Values. Set the following values:
 - SBSL: 120
 - SBSW: 60
 - SFL: 108
 - SFW: 48
 - SBSH: 48Click the Update Model button in the Edit Part Sizes dialog box toolbar. Click OK. This updates the model parameter values to match the size parameters.
- 8 Right-click Model Parameters and then click Edit. Set the value of LenB1 to SFH. Click Close. LenB1 is the dimension that represents the depth of the outer frame extrusion.

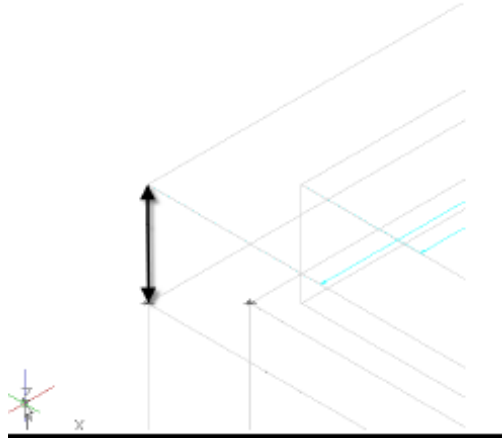

- 9 Expand Modifiers. Right-click Box and turn off the visibility. Turn on the visibility of Box Outside and Box Inside. This displays the appropriate modifiers for dimensioning.
- 10 Right-click Model Dimensions and then click Add Distance. Click the outer box extrusion in the drawing, then click a location for the dimension.

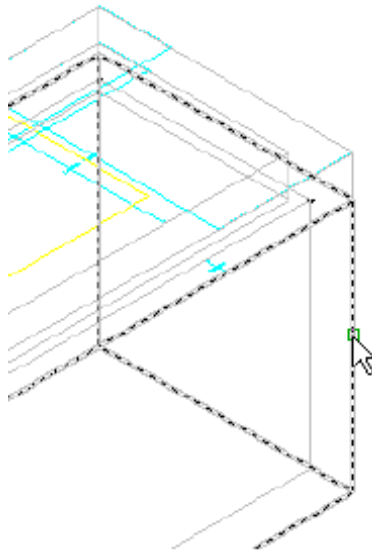

Dimension LenB3 is created.

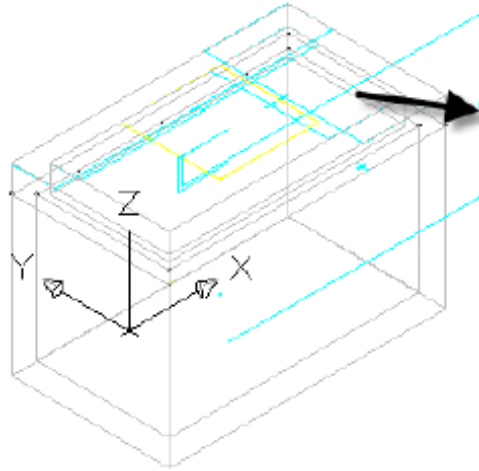

11 Repeat this step for the inner box extrusion.

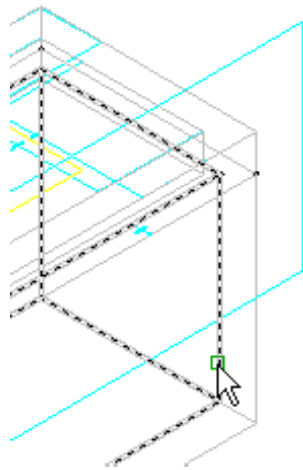

Dimension Len B4 is created.

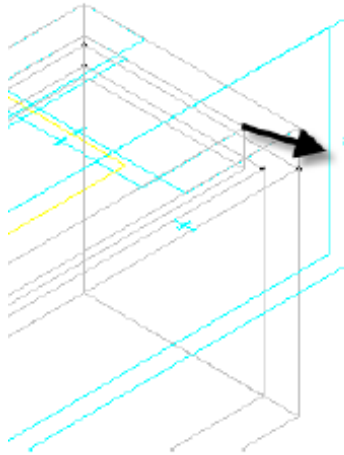

- 12 Right-click Model Parameters, click Edit, and set the equation for LenB3 to $\text{LenB4} + \text{Fth}$ (floor thickness). While the Model Parameters dialog box is displayed, set the value for Fth to 4. Len B3 is the length of the Box Outer extrusion which is set to the Box Inner extrusion length plus the thickness of the floor.
- 13 Equate dimension LenB4 to $\text{SRS} - \text{SFH}$ (rim to sump height - frame height). Change the value of SRS to 48.
- 14 Equate SBSH to $\text{LenB1} + \text{LenB3}$. Click Close. SBSH is the Structure Height parameter.

NOTE This parameter will be visible in AutoCAD Civil 3D, but will not be able to be edited by the user. It is important that this parameter does not evaluate to zero. If it does, the part will not display in AutoCAD Civil 3D.

- 15 Make the following changes to Size Parameters.
 - Fth
 - Change to List
 - Set List to 4,8,12
 - Set the value to 4
 - Wth
 - Change to List

- Set list to 4,8,12
- Set the value to 4
- Add SIL (Inner Structure Length)
 - Change to List
 - Set List to 12 inch increments from 48 to 120
 - Set value to 120
- Add SIW (Inner Structure Width)
 - Change to List
 - Set List to 12 inch increments from 36 to 60
 - Set value to 60
- SRS
 - Change to Range
 - Set Minimum Value to 36
 - Set Maximum Value to 120
 - Set Default Value to 72

Fth = Floor thickness and Wth = Wall thickness. These parameters will be available in three sizes, and will be editable structure properties in AutoCAD Civil 3D.

SIL=Inner Structure Length and SIW=Inner Structure Width. These parameters will be available in a number of sizes at 12-inch increments. These are the key structure properties that control the length and width of the part in AutoCAD Civil 3D.

RS=Rim to Sump height. This is a key structure property that will allow the depth of the structure to be controlled in AutoCAD Civil 3D.

Click Save Part Family when you are finished so that the part is saved, and the Model Parameters are updated to include the new Size Parameters.

- 16** Right-click Size Parameters and then click Edit Values. Change the following:
- SBSL=120
 - SBSW=60

- $SFL=108$

- $SFW=48$

Click the Update Model button in the Edit Part Sizes dialog box toolbar, and then click OK.

17 Right-click Model Parameters and then click Edit. Make the following changes in the Equation column for each of the following. Make the changes in the order shown.

- LenA1: $SIL + (2 \cdot Wth)$ - LenA1 is the model dimension for the outer length of the box. It has been set to the Inside Structure Length (SIL) plus the thickness of each wall ($2 \times Wth$).

- LenA2: $SIW + (2 \cdot Wth)$ - LenA2 is the model dimension for the outer width of the box. It has been set to the Inside Structure Width (SIW) plus the thickness of each wall ($2 \times Wth$).

- SBSL: LenA1 - SBSL and SBSW are important structure properties that have been set to the actual model dimensions.

- SBSW: LenA2

- SVPC: $SFH + 6$ - The vertical pipe clearance (SVPC) has been set to the frame height (SFH) plus six inches.

18 Expand Work Planes \blacktriangleright Rim \blacktriangleright Geometry. Right-click Fixed Center \blacktriangleright Visible. The rim center point is displayed in the drawing.

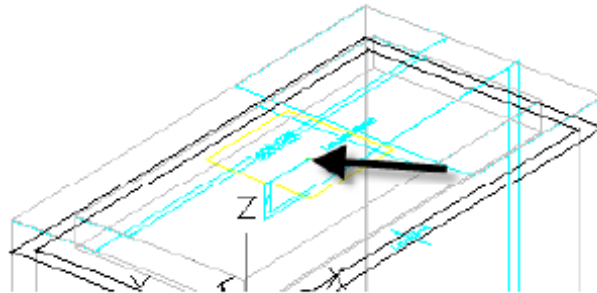

19 Expand Autolayout Data. Right-click Layout Data and then click Set Placement Point. Use the NODE object snap to select the Fixed Center point. The placement point is much like an insertion point for an AutoCAD block.

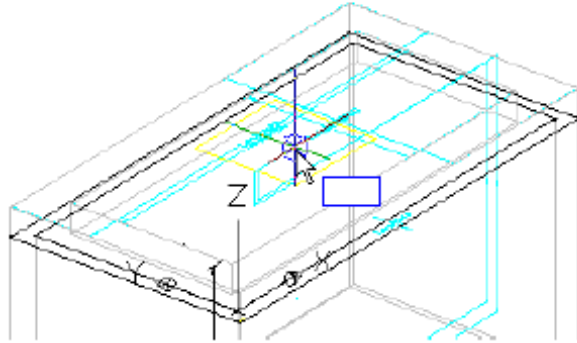

- 20 Expand Modifiers. Turn on the visibility of Frame and Box. Turn off all other modifiers.
- 21 Click Generate Bitmap.
- 22 Click SW Isometric View. Click OK. A bitmap image has been generated for the part catalog.

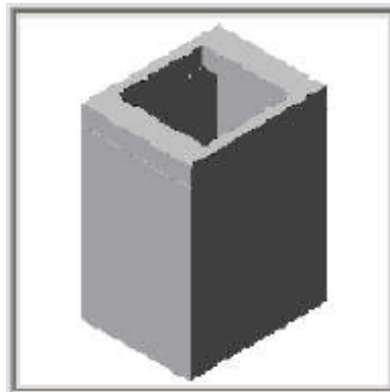

- 23 Click Save Part Family. Exit the Part Builder Environment.



To continue this tutorial, go to [Exercise 5: Using the New Part](#) (page 735).

Exercise 5: Using the New Part

In this exercise, you will insert the new vault part into a AutoCAD Civil 3D pipe network, and investigate how it behaves as a pipe network structure.

For more information, see the AutoCAD Civil 3D Help topic *Understanding Part Builder*.

This exercise continues from [Exercise 4: Finalizing the Part](#) (page 728).

- 1 Make sure that you have closed the Part Builder environment from the previous exercise.
- 2 In the AutoCAD Civil 3D window, click Quick Access toolbar  Open. Navigate to the [tutorial drawings folder](#) (page 819). Open the drawing *Part Builder-3a.dwg*. This drawing contains a simple sanitary sewer pipe network.
- 3 In the Toolspace Settings tab, expand Pipe Networks  Parts Lists, and then right-click Sanitary Sewer and then click Edit.
- 4 Click the Structures tab. Right-click Sanitary Sewer and then click Add Part Family.
- 5 Check the box next to Vault 5106-LA with Top 5106-TL3-332. Click OK. The part family is added to the parts list.
- 6 Right-click Vault 5106-LA with Top 5106-TL3332, and then click Add Part Size. Note the new part size that has been included.
- 7 Click OK to add a single part size with the default values. Expand Vault 5106-LA with Top 5106-TL3-332. Note the new part size that has been included.
- 8 Click OK. Click the sanitary sewer manhole in any of the drawing views. Right-click and then click Swap Part.



- Expand Vault 5106-LA with Top 5106-TL3-332, and select the part beneath it. The part now is displayed as the vault in 3D view, but still is displayed as a manhole in plan view.

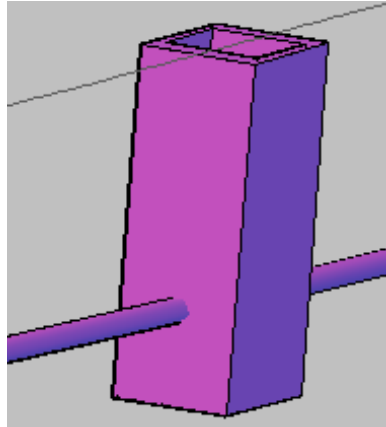

- Click the structure in any of the views. Right-click and then click Structure Properties.
- Click the Information tab. Click the black triangle next to the edit button, and select Create New.
- Click the Information tab. Enter Model for Name.
- Click the Profile tab. Click Display as solid.
- Click the Display tab. Set the visibility for Model 3D Solid to On.
- Click OK twice. Note the change to the appearance of the structure in plan view. The vault structure now is displayed with its actual dimensions.

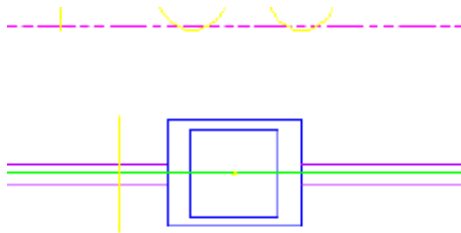

- Click the vault structure. Right-click and select Structure Properties. Click the Part Properties tab.

17 Change the following:

- Frame Length = 108
- Frame Width = 48
- Inner Structure Length = 120
- Inner Structure Width = 60

18 Click OK. Note the change to the structure in the drawing. The structure has been updated with the new dimension properties.

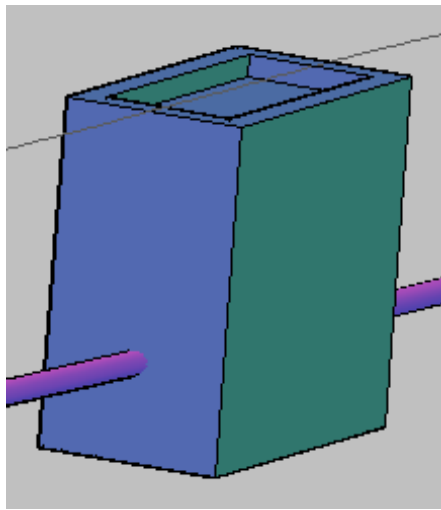

19 Save and close the drawing.

Labels and Tables Tutorials

19

These tutorials will get you started creating and editing labels, label styles, and tables.

In AutoCAD Civil 3D 2011, you can annotate objects that exist in externally referenced drawings. This keeps annotations separate from the design data. This greatly reduces the file size of the annotation drawing, and allows greater flexibility in managing design data.

Object labels in AutoCAD Civil 3D include types that are placed automatically and others that you can place manually at points of interest. Sometimes, automatic labels overlap other objects and must be moved. Also, you may want to make some of them look different from others.

Most objects in AutoCAD Civil 3D have two types of labels. The first type is automatically created when the object is created, as defined by the object properties. The second type is a range of object labels that are manually applied as needed. For both types of labels, you can edit the label style and make changes to all labels that use that style. You can also modify individual labels by moving them manually in the drawing. When labels are moved, they assume their dragged state, which can use a different display format. Some labels can be converted to small tags that occupy less space in the drawing, and then the data for each tagged object can be displayed in a table.

Labels are distinct objects that are independent of the parent object that they annotate. Labels are dynamically linked to their parent object and automatically update when the parent object changes. However, labels reside on a separate layer and are not selected when you select the parent object.

NOTE Point, parcel area, corridor, and surface watershed labels are not object type labels. They are sub-entities of a parent object and their properties are managed in the Label Properties dialog box.

You can move most labels by simply selecting and dragging them. When you move a label, a line and a direction arrow is automatically created, which points back to the precise point annotated by the label. Also, you can flip labels along a linear object, such as a parcel segment, to the other side of the line.

The easiest way to change the format of a label is by changing its style. If a suitable style is not available, you can copy an existing style that is similar to what you want, make the required changes, and save it as a new style. You can also change the attributes of the existing

style. This action requires some forethought, because your changes affect all objects in the drawing that use the style.

Label visibility can be controlled in several ways. First, label visibility is dependent on the parent object. When the layer of the parent object is either turned off or frozen, its labels are also turned off or frozen. The label style can also control its visibility. The visibility of the individual label components, or the entire label object, can be turned on or off in the style. An individual label can also be selected and turned on or off using the Properties palette.

For more information, see the AutoCAD Civil 3D Help topic *Understanding Labels*.

Tutorial: Preparing to Annotate a Drawing

This tutorial demonstrates how to perform some optional tasks that can make annotating your drawing easier.

First, you will create external references (Xrefs) to drawings that contain the objects that you will annotate in later Labels and Tables tutorials. Second, you will learn how to use the AutoCAD Civil 3D ribbon to locate all of the annotation commands.

For more information, see the AutoCAD Civil 3D Help topic *Understanding Labels* and the AutoCAD Help topic *Attach Drawing References (Xrefs)*.

Exercise 1: Attaching Drawings as Xrefs for Annotation

In this exercise, you will attach several drawings to one drawing. By attaching drawings, you can annotate multiple large objects in a single compact drawing.

Detailed labeling is usually one of the last steps in the design process. In AutoCAD Civil 3D 2011, you do not have to annotate objects in the drawings in which they reside. You can create a single drawing with external references (Xrefs) to the object drawings. This process enables you to keep your annotation drawing size to a minimum, while maintaining the benefit of dynamic label updates.

For more information, see the AutoCAD Help topic *Attach Drawing References (Xrefs)*.

Attach drawings as Xrefs for annotation

1 Using Windows Explorer, navigate to the [tutorial drawings folder](#) (page 819). Select all of the drawings that have names beginning with *Labels-*. Click Edit menu ► Copy.

2 Navigate to the [My Civil Tutorial Data folder](#) (page 819). Click Home tab ► Clipboard panel ► Paste drop-down ► Paste.

In a later exercise, you will modify some of the externally referenced drawings. To make the modifications, the drawings must be in a location to which you have write access.

3 Open *Labels-1a.dwg*, which you saved in the [My Civil Tutorial Data folder](#) (page 819) in step 2.

4 In Toolspace, on the Prospector tab, expand the *Labels-1a* drawing.

Although a surface with an outside boundary is displayed in the drawing window, notice that the Surfaces collection is empty. The Surfaces collection is empty because the composite surface is an external reference, or Xref. The surface data, which is quite large, exists in a separate drawing.

TIP In large projects that have multiple surfaces, each surface object should reside in its own drawing. For example, the existing ground surface should exist in one drawing, with other drawings containing data references to it. For example, the proposed ground surface should exist in its own drawing, with a data reference to the existing ground surface.

5 On the command line, enter XREF.

In the External References dialog box, notice the difference in size between the current drawing (*Labels-1a*) and the externally referenced drawing that contains the surface (*Labels-Surface*). While the surface object appears in the current drawing, the size of the current drawing is a fraction of the surface drawing. Using Xrefs, you can use data from another drawing without actually inserting the data.

6 In the External References palette, click the arrow next to . Click Attach DWG.

NOTE Notice that you can also attach a drawing from Vault.

7 In the Select Reference File dialog box, navigate to the [My Civil Tutorial Data folder](#) (page 819). Select the drawings *Labels_Alignments.dwg* and *Labels_Parcels.dwg*. Click Open.

- 8 In the External Reference dialog box, make sure that the following settings are selected:

■ Reference Type: Attachment

This setting specifies that the Xrefs remain with the current host drawing (*Labels-1a.dwg*) if the current drawing is attached as an Xref to another drawing. If Overlay is selected, Xrefs that exist in the drawing are ignored if the drawing is attached to another drawing as an Xref.

■ Path Type: Relative Path

This setting specifies that if you move the current and referenced drawings to another location, the references are less likely to be lost.

TIP Before creating an Xref, make sure that the referenced drawings are saved in the same directory as the current drawing.

IMPORTANT Attached Xrefs must have the following settings. If the insertion point, scale, or rotation is different from the current drawing, the AutoCAD Civil 3D labels will not work.

■ Insertion Point, Specify On-Screen: Cleared

■ Scale, Specify On-Screen: Cleared

■ Scale, Uniform Scale: Selected

■ Rotation: Specify On-Screen: Cleared

- 9 Click OK.

The alignments and parcels appear in the drawing window, and the drawings in which they reside are listed in the External References palette. Close the External References palette.

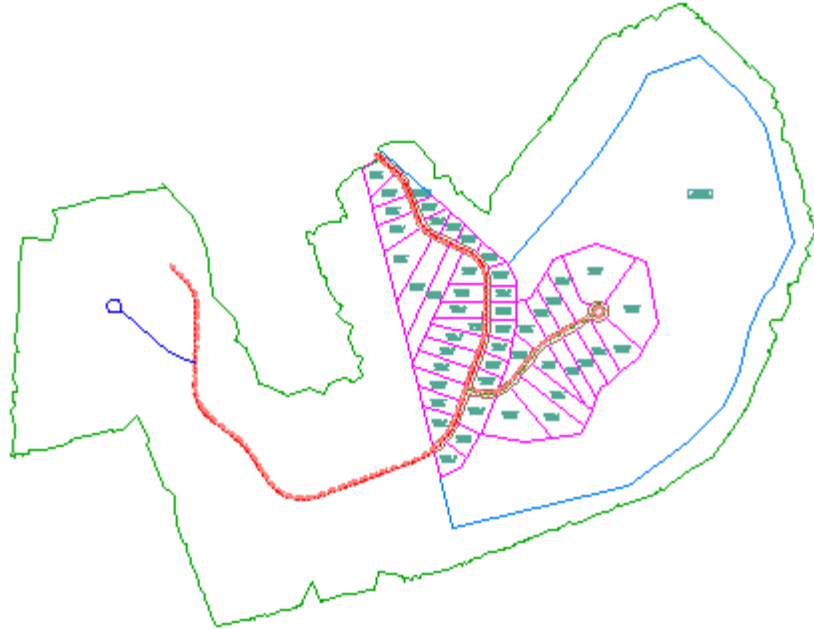

Drawing with multiple externally referenced drawings

To continue this tutorial, go to [Exercise 2: Exploring the Annotation Tools on the Ribbon](#) (page 743).

Exercise 2: Exploring the Annotation Tools on the Ribbon

In this exercise, you will learn how to locate annotation tools on the ribbon tabs.

For more information, see the AutoCAD Civil 3D Help topic *Understanding Labels*.

This exercise continues from [Exercise 1: Attaching Drawings as Xrefs for Annotation](#) (page 740).

Examine the Annotate tab

NOTE This exercise uses *Labels-1a.dwg* with the modifications you made in the previous exercise.

- 1 Click the Annotate tab.
This tab contains both AutoCAD Civil 3D and standard AutoCAD annotation tools.
- 2 Click Labels and Tables panel ► Add Labels drop-down.
Notice that the menu consists of label and table commands for the AutoCAD Civil 3D features. You can access the label or table commands for each feature directly from this menu.
- 3 Press Esc.
- 4 Click Add Labels.
In the Add Labels dialog box, you can select the feature, label type, and label style. This dialog box enables you to easily switch these settings as needed while annotating your drawing. You will use this dialog box throughout the labels tutorials.
- 5 Click Close.

Examine the object tabs

- 1 Click Modify tab ► Ground Data panel ► Surface.
- 2 Click Surface tab ► Labels and Tables panel ► Add Labels drop-down.
Notice that the menu consists of label and table commands for surfaces only. Each object tab contains an object-specific list of label and table commands.

To continue to the next tutorial, go to [Tutorial: Adding and Editing Labels](#) (page 744).

Tutorial: Adding and Editing Labels

This tutorial demonstrates how to add labels to AutoCAD Civil 3D objects, and then edit the labels to suit your requirements.

Labels are defined by the following properties. You will learn how to work with many of these properties in later tutorial exercises.

- **Location.** Label location in a drawing depends on the object using the label.
For example, a parcel area label is usually placed at the center of the parcel, and surface contour labels are usually placed on the contour line.
- **Appearance and Visibility.** Whether a label is visible, and how it appears in a drawing, can be specified in the label style or by managing the AutoCAD properties. You can define different display settings, such as color, lineweight, and linetype, for each label component.
- **Mode.** Many label styles have two modes: label and tag. Tags identify labeled objects within a table.
- **Behavior.** Labels behave according to their association with objects. For example, if you move an object in a drawing, the label moves with it. Also, behavior can also determine how a label is positioned or oriented in a drawing.
- **Anchor.** A label is placed in relation to an object or another label style component.
- **Plan-Readable Text.** Labels can be placed at any angle, but you can select a plan-readability setting to maintain upright legibility.

For more information, see the AutoCAD Civil 3D Help topic *Inserting and Managing Labels in Drawings*.

Exercise 1: Adding Labels in Groups

In this exercise, you will use label sets to apply several types of labels to an alignment.

You can automatically add labels as you create objects, such as points, alignments, or parcels. Labeling an object automatically is an efficient way to annotate common elements, such as alignment stations or parcel areas, as they are created.

In this exercise, you will specify a label set to apply as you create an alignment from a polyline. Both the newly created alignment and its labels will reside in the current drawing. Next, you will learn how to modify the properties of the label set after the alignment has been created. Finally, you will learn how to apply a label set to an alignment that exists in an externally referenced drawing.

For more information, see the AutoCAD Civil 3D Help topic *Adding Labels to Drawings*.

Create a label set for a new alignment

NOTE This exercise uses *Labels-1a.dwg* with the modifications you made in the previous exercise, or you can open *Labels-2a.dwg* from the [tutorial drawings folder](#) (page 819).

- 1 Click Home tab ► Create Design panel ► Alignment drop-down ► Create Alignment From Objects . On the command line, enter X to select the Xref option.
- 2 Click the blue polyline on the west side of the site.

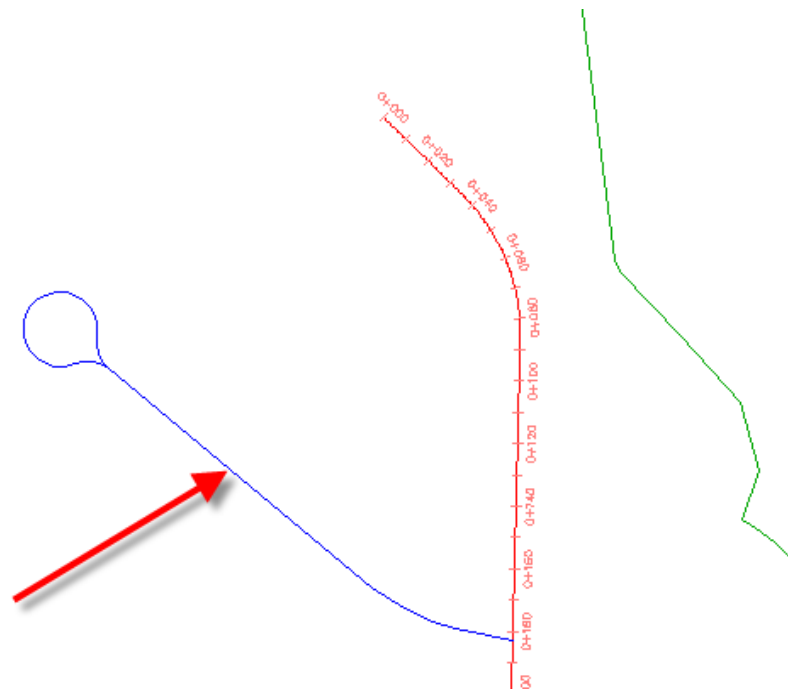



Polyline in the externally referenced drawing

- 3 Press Enter twice.

- 4 In the Create Alignment - From Polyline dialog box, for Name, enter West Street. For Alignment Style, ensure that Proposed is selected. Examine the contents of the Alignment Label Set list.

When you create an object, its Create dialog box typically has style selector lists for both the object and the labels. The style selector lists identify the object styles and label styles that are available in the current drawing for that object type. When you create an alignment, profile, or section, you select a *label set*, which applies a preset style to each of the various labels types that are in the set. You will examine an example of a label set in the following steps. Notice that there is a *_No Labels* selection. This selection is an empty label set that does not display any labels along the alignment.

TIP If you do not want to annotate objects that do not use label sets, you can create a label style that has the visibility of all of its components turned off.

- 5 From the Alignment Label Set list, select Major Minor And Geometry Points. Click the arrow next to . Select  Copy Current Selection. The Alignment Label Set dialog box displays information about how the Major Minor and Geometry Points label set is configured. You will use this label set as a basis to create a new label set.

The Information tab displays the label set name, description, and the date when it was created or modified.

The Labels tab specifies the label types that are defined in the label set, as well as the label styles that are used by each type. In this example, you use the label set to apply label styles to the geometry points and major and minor stations of an alignment.

NOTE Label sets for profiles and sections are constructed in the same manner, using a similar dialog box.

- 6 In the Alignment Label Set dialog box, on the Information tab, for Name, enter Major-Minor Stations And Start-End Points.
- 7 On the Labels tab, in the Geometry Points row, in the Style column, click .
- 8 In the Pick Label Style dialog box, select Alignment Start. Click OK.

9 In the Alignment Label Set dialog box, in the Geometry Points row, in the Geometry Points To Label column, click .

10 In the Geometry Points dialog box, click  to clear all check boxes. Select the Alignment Beginning check box. Click OK.

You can use geometry point label types to label a selection of geometry points using a combination of styles that you specify. In steps 8 and 9, you applied a geometry point label style to the alignment starting station. In the following steps, you will create another instance of the Geometry Points label type that applies a different style to the alignment ending station.

TIP To remove a label type from the label set, select the type and click .

11 In the Alignment Label Set dialog box, on the Labels tab, specify the following parameters:

- Type: Geometry Points
- Geometry Point Label Style: Alignment End



12 Click Add.

13 In the Geometry Points dialog box, click  to clear all check boxes. Select the Alignment End check box. Click OK.

14 In the Alignment Label Set dialog box, click OK.

15 In the Create Alignment - From Polyline dialog box, under Conversion Options, clear the Add Curves Between Tangents check box. Click OK.

16 Zoom in to the area surrounding the new alignment and examine the labels that were automatically placed along the alignment.

NOTE If the EP: 0+243.63 label is adjacent to the intersecting alignment, click Alignment tab ► Modify panel  Reverse Direction . Click the alignment. Click OK to acknowledge the warning about alignment properties that are affected by the command.

When the alignment is created, it is green. The green color is controlled by the alignment style that you specified in step 3. Notice that the new

red labels are a brighter than the labels that were brought in with the externally referenced objects. The color tones are different so that you can easily identify where the labels reside: bright labels are in the current drawing, and light labels are in the externally referenced drawings.

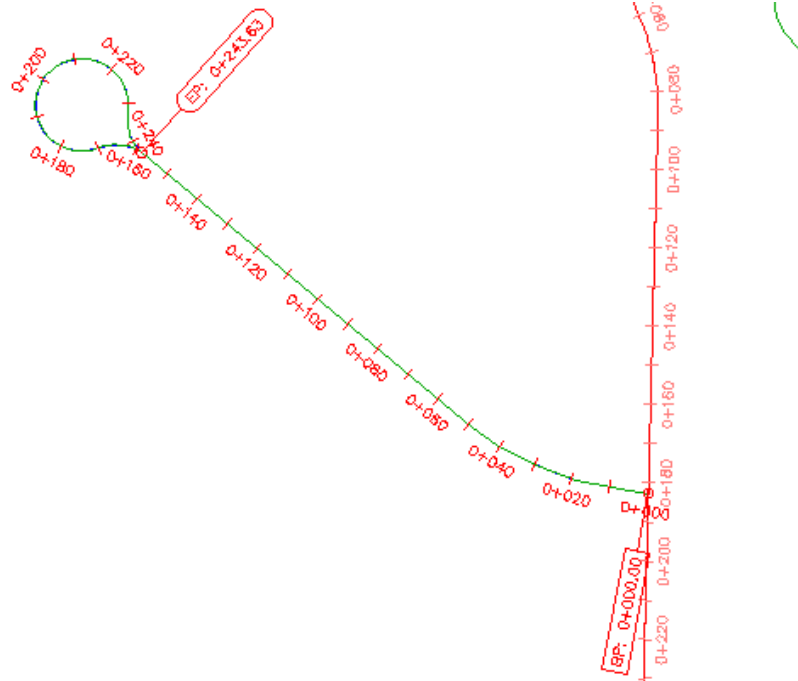

Label set applied to a newly created alignment

Modify the label set of an existing alignment

NOTE Changes that you make to the alignment label set after the alignment has been created will not be applied to the original label set. To edit the original label set, in Toolspace, on the Settings tab, expand Alignment ► Label Styles ► Label Sets. Right-click the appropriate label set. Click Edit.

- 1 In the drawing, select the West Street alignment. Right-click. Click Edit Alignment Labels.
- 2 In the Alignment Labels dialog box, specify the following parameters:
 - Type: Geometry Points

- Geometry Points Label Style: Perpendicular With Tick And Line
- 3 Click Add.
 - 4 In the Geometry Points dialog box, click  to clear all check boxes. Select the following check boxes:
 - Tangent-Tangent Intersect
 - Tangent-Curve Intersect
 - Curve-Tangent Intersect
 - 5 Click OK to close the Geometry Points and Alignment Label Set dialog boxes.
 - 6 Press Esc to deselect the alignment.

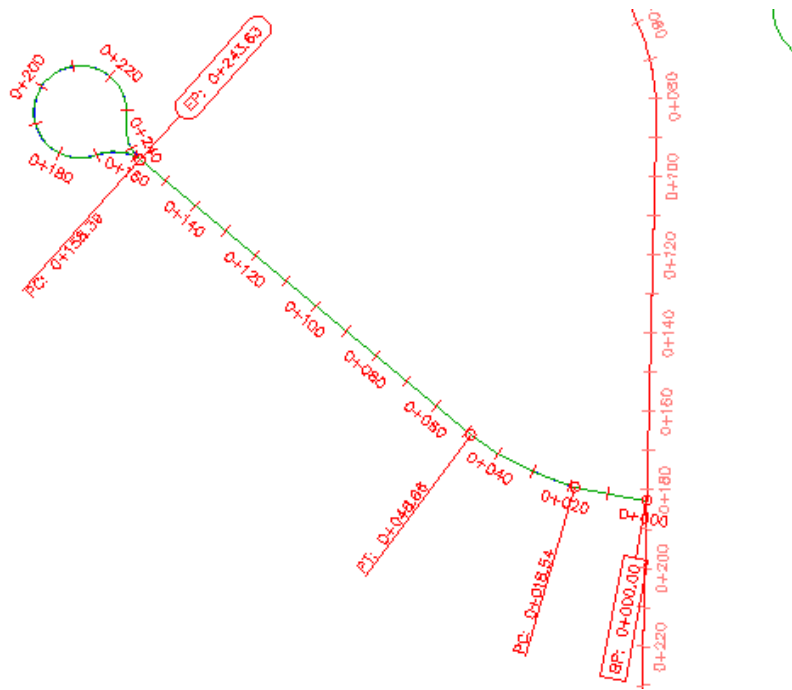

Alignment with modified label set

NOTE In the previous image, the EP: 0+243.63 and PC: 0+158.39 labels are shown on opposite sides of the alignment for clarity. You will learn to flip labels to the opposite side of an alignment in a later exercise.

Add labels to an alignment in a referenced drawing

- 1 Click Annotate tab ► Labels & Tables panel ► Add Labels menu ► Alignment ► Add/Edit Station Labels . Click the Main Street alignment, which is the long alignment in the middle of the site. Because this alignment exists in an externally referenced drawing, the table in the Alignment Labels dialog box is empty. Only labels that are created in the current drawing can be modified in the current drawing. Labels that were created in an externally referenced drawing must be modified in the source drawing.

- 2 In the Alignment Labels dialog box, specify the following parameters:
 - Type: Geometry Points
 - Geometry Point Label Style: Perpendicular With Tick And Line

- 3 Click Add.

NOTE The Import Label Set button applies a label set that exists in the current drawing.

- 4 In the Geometry Points dialog box, click OK.
- 5 In the Alignment Labels dialog box, specify the following parameters:
 - Type: Design Speeds
 - Design Speed Label Style: Station Over Speed

- 6 Click Add.

- 7 Click OK.

On the Main Street alignment, labels are displayed at each station at which a new design speed is applied, and at each geometry point. These label objects reside in the current drawing and annotate the alignment in the externally referenced drawing.

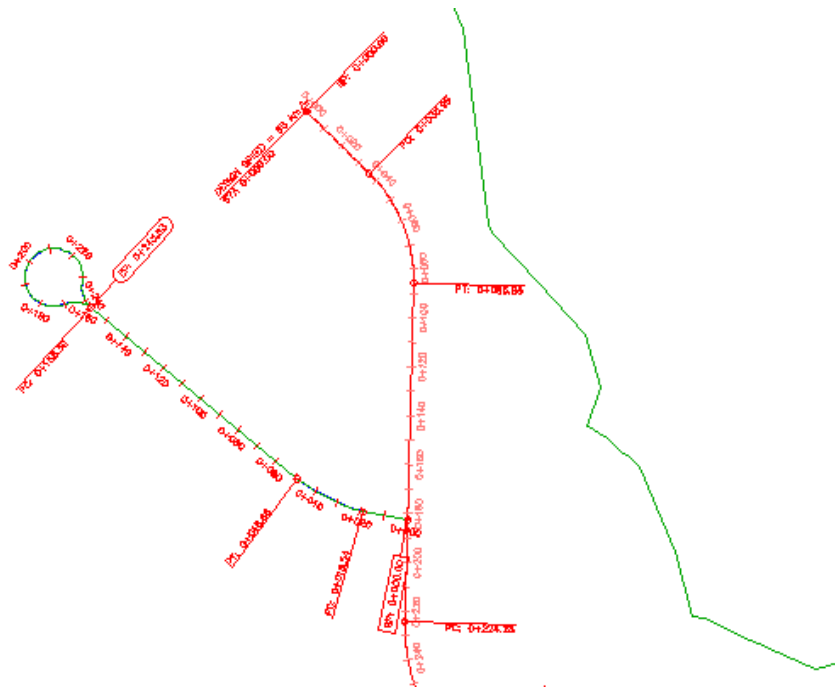

Labels added to an alignment in an externally referenced drawing

To continue this tutorial, go to [Exercise 2: Manually Labeling an Object](#) (page 752).

Exercise 2: Manually Labeling an Object

In this exercise, you will add labels to specific areas on an alignment after it has been created and automatically labeled.

For more information, see the AutoCAD Civil 3D Help topic *Adding Labels to Drawings*.

This exercise continues from [Exercise 1: Adding Labels in Groups](#) (page 745).

Label multiple alignment segments

NOTE This exercise uses *Labels-2a.dwg* with the modifications you made in the previous exercise.

- 1 Click Annotate tab ► Labels & Tables panel ► Add Labels menu ► Alignment ► Add Alignment Labels .
- 2 In the Add Labels dialog box, specify the following parameters:
 - Feature: Alignment
 - Label Type: Multiple Segment
- 3 In the three label style fields, accept the default styles.
You can choose specific styles for each of the Line, Curve, and Spiral label styles. This alignment does not contain any spirals, so the Spiral Label Style setting is ignored.
- 4 Click Add.
- 5 On the left-hand side of the site, click the West Street alignment, which you created in [Exercise 1: Adding Labels in Groups](#) (page 745).
The Multiple Segment label command places a label at the middle of each line and curve. This method can be convenient, but sometimes a few of the labels overlap other features of the drawing. In [Exercise 3: Selecting and Moving Labels](#) (page 755), you will move some of these labels.

Label single alignment segments

- 1 In the Add Labels dialog box, specify the following parameters:
 - Feature: Alignment
 - Label Type: Single Segment
 - Line Label Style: Line Label Style ► Alignment Name

NOTE Notice that you can use either a General Line Label Style or Alignment Line Label Style. General Line and Curve label styles can be applied to lines and curves that are part of an Alignment or Parcel object.

- 2 Click Add.

You are now ready to choose a specific location for a label on the alignment. Unlike multiple segment labels, single segment labels are placed exactly where you click.

- 3 On the West Street alignment, click near station 0+120 to place a line segment label. Be sure to click the line segment, and not the station label. Because you clicked a line segment, the label style specified in the Line Label Style list in the Add Labels dialog box was used. If you had clicked a curve, the label style specified in the Curve Label Style list would have been used.
- 4 On the Main Street alignment, which is the long alignment in the middle of the site, click a location between stations 0+140 and 0+160.
- 5 On the East Street alignment, which is the alignment with the cul-de-sac on the right-hand side of the site, click a location between stations 0+200 and 0+220.
- 6 In the Add Labels dialog box, in the Line Label Style list, select Line Label Style ► Bearing Over Distance. Click Add.
- 7 On the Main Street alignment, click a location between stations 0+100 and 0+120. A new label displaying bearing and distance information is created.

Examine label settings for other objects

- 1 In the Add Labels dialog box, in the Feature list, select Parcel.
This selection changes the label type and style selections that are available. The Add Labels dialog box works in the same manner for all of the feature types shown in the Feature list. When you annotate objects in AutoCAD Civil 3D, you can switch the type of object you are labeling, as well as the label type and style of the various elements, as needed.
Pay attention to the command line as you annotate objects. Some label types, such as span, slope, grade, and depth, annotate a range of data between two points. For example, if you want to label a grade or depth between two points, you must specify those points in the drawing.
- 2 In the Add Labels dialog box, click Close.

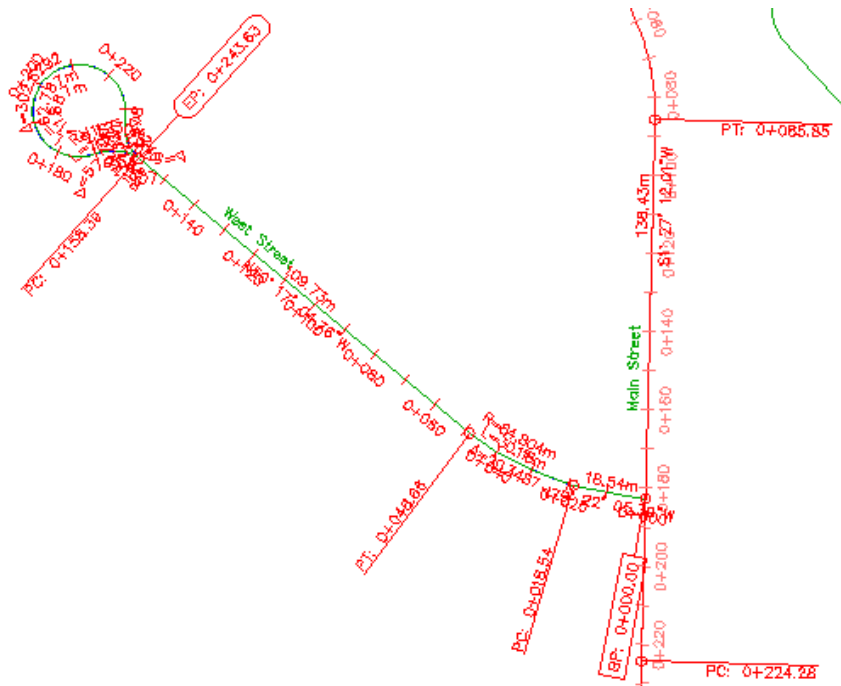

Alignment with manually inserted segment labels

To continue this tutorial, go to [Exercise 3: Selecting and Moving Labels](#) (page 755).

Exercise 3: Selecting and Moving Labels

In this exercise, you will select labels and change their location in the drawing.

Your drawing currently contains many labels, some of which overlap one another. You will move them in the following steps.

Some label types, such as alignment station and geometry point labels, are part of a label type group that shares properties. When you click one label in the group, the entire group is selected. Properties for the group are controlled using the AutoCAD Properties palette, which is available when you select the group, right-click, and click Label Properties. You can select the group and then change the properties of all labels in the group simultaneously. Alternatively, you can use Ctrl+click to select and change label properties individually.

Other label types, such as segment labels, are not part of a group. Each of these labels is treated as an individual object.

Labels are distinct objects that are independent of the parent object that they annotate. Labels are dynamically linked to their parent object and automatically update when the parent object changes. However, labels reside on a separate layer and are not selected when you select the parent object.

If a label resides in an externally referenced drawing, the label cannot be edited in the current drawing.

NOTE Point, parcel area, corridor, and surface watershed labels are not object type labels. They are sub-entities of a parent object and their properties are managed in the Label Properties dialog box.

For more information, see the AutoCAD Civil 3D Help topic *Moving Labels in a Drawing*.

This exercise continues from [Exercise 2: Manually Labeling an Object](#) (page 752).

Select labels in a drawing

NOTE This exercise uses *Labels-2a.dwg* with the modifications you made in the previous exercise, or you can open *Labels-2b.dwg* from the [tutorial drawings folder](#) (page 819).

- 1 Make sure that you are zoomed in to the area around the West Street label on the alignment on the left-hand side of the site.
- 2 Select the alignment.
Notice that the alignment is highlighted, and grips appear along the alignment. The alignment labels, however, are not highlighted.
In previous versions of AutoCAD Civil 3D, labels were sub-entities of their parent object. Now, most AutoCAD Civil 3D labels are independent objects that reside on their own layer. Although they are independent objects, labels are dynamically linked to their parent object and automatically update to reflect changes in the parent object.
- 3 Press Esc to deselect the alignment.
- 4 On the road alignment, click one of the station labels.
Notice that all other station labels along the alignment are now highlighted.
- 5 Press Esc to deselect the station labels.

6 Click one of the curve labels.

Notice that while that curve label is selected, the other curve labels are not.

There are two distinct label object types:

- *Label type groups*—When you select a label that is part of a label type group, such as an alignment station label, the entire group is selected. If you select a label type group and use the right-click menu to update the label properties, the properties of every label in the group update. To select a single label within a label type group, use Ctrl+click.
- *Single label objects*—When you select a single label object, such as an alignment curve label, only that label object is selected. You can change the properties, including the label style, of single label objects without affecting the other labels of the parent object.

7 Press Esc to deselect the curve label.

Move labels in the drawing

- 1 Click the label showing bearing over distance near station 0+100. Grips appear on the label.
- 2 Click the  label location grip. The grip turns red. Drag the label down and to the left to move it to a clear location. Click to place the label. Press Esc to deselect the label.

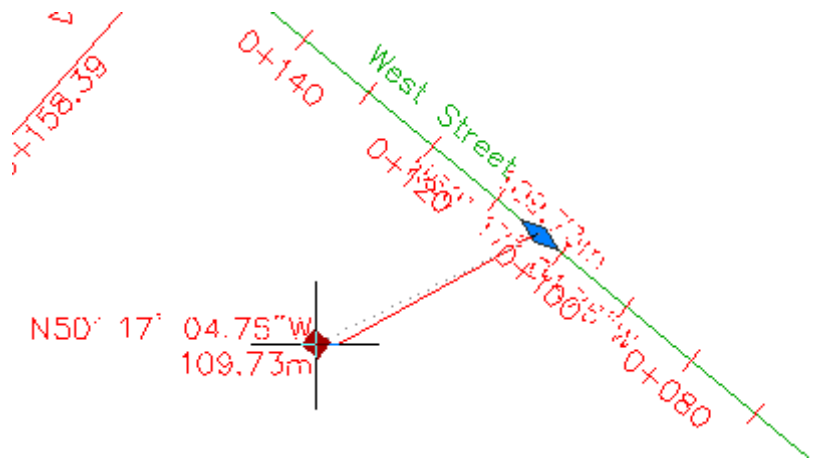

Label dragged with the label location grip

A leader line is created from the label to the alignment.

- 3 Click the West Street label. Grips appear on the label.
- 4 Click the  label anchor grip. The grip turns red. Drag the label to the right. Click near station 0+100 to place the label closer to the center of the line segment. Press Esc to deselect the label.

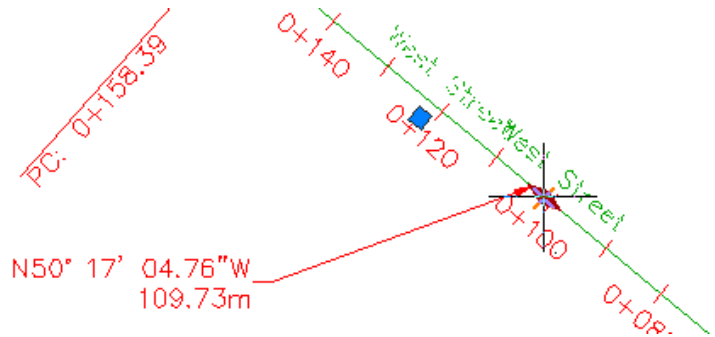

Label moved with label anchor grip

- 5 Pan and zoom to the cul-de-sac of the West Street alignment.
- 6 Use the  grips to drag each curve label away from the alignment.
- 7 Click the EP: 0+243.63 label. A grip appears on the label.
- 8 Click the grip. The grip turns red. Drag the label up and to the right to move it to a clear location.

A leader line is created from the label to the alignment.

Notice that the label displays without a border. The border is hidden because the *dragged state* of the label style specified a different format for when the label is dragged to a new location. You will learn about label style settings in the [Working with Label Styles tutorials](#) (page 776).

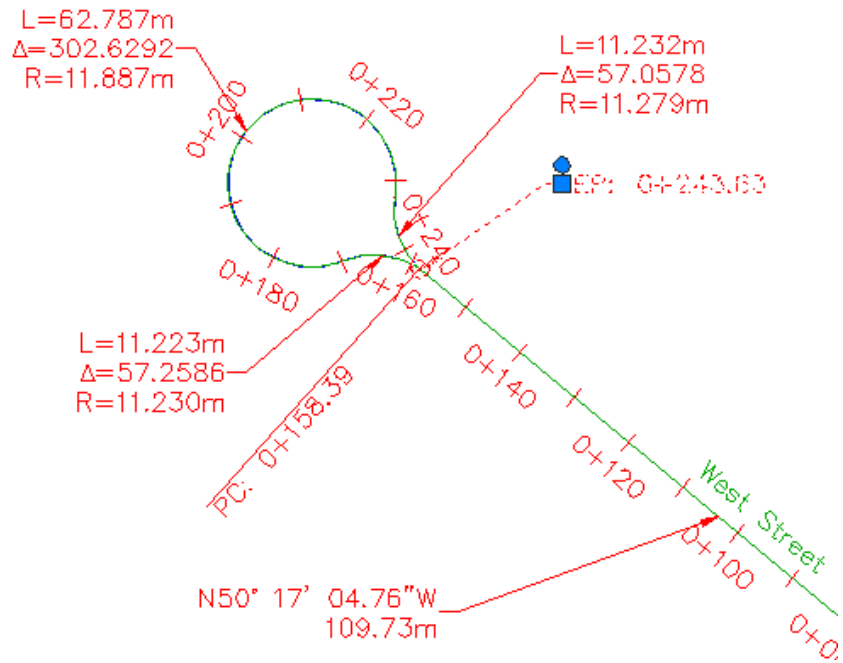

Alignment end point label displayed in dragged state

NOTE You can reset a selected label by clicking the  circle grip.

- 9 Press Esc to deselect the EP: 0+243.63 label.
- 10 Ctrl+click station label 0+000. Press Delete.
- 11 Repeat these operations, moving and dragging labels to other locations where required. If you want to undo any flipping or dragging operations, select the labels in question. Right-click and click Reset Label.

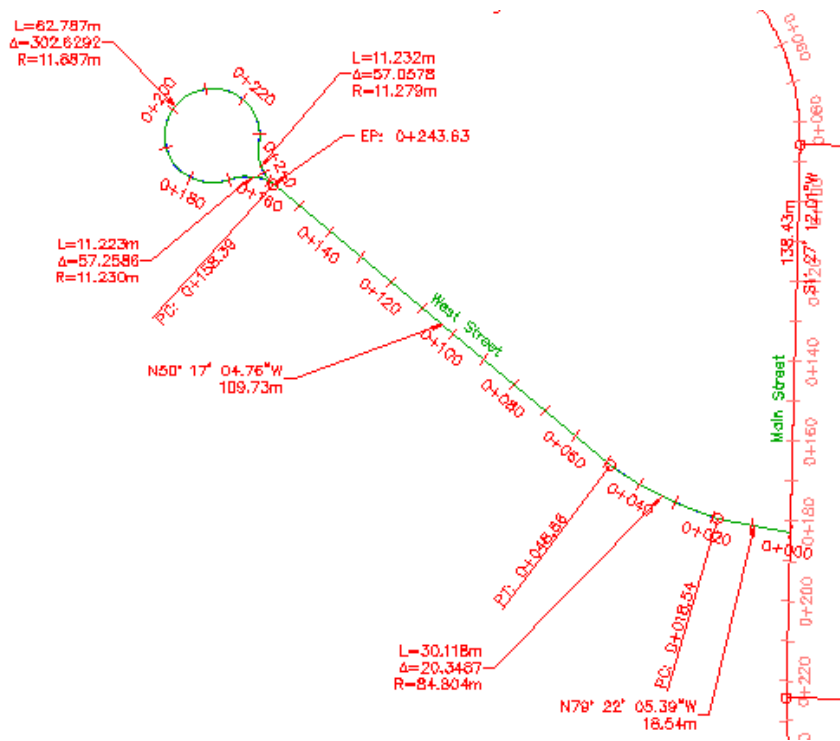

Alignment with labels moved to improve readability

Select labels in an Xref

- 1 Click one of the station labels on the Main Street alignment.
Notice that both the Main Street and East Street alignments and their station labels are selected. The labels were selected because the labels were created in the externally referenced drawing in which the alignments reside. When an object has been created through an Xref, you can edit its labels only in the source drawing.
- 2 Press Esc to deselect the Xref.

To continue this tutorial, go to [Exercise 4: Working with Label Properties](#) (page 761).

Exercise 4: Working with Label Properties

In this exercise, you will use standard AutoCAD tools to control properties for both individual labels and group labels.

You can change the properties of:

- an individual label object
- a label object group
- an individual label object

In this exercise, you will change all of these properties.

For more information, see the AutoCAD Civil 3D Help topic *Modifying Labels in a Drawing*.

This exercise continues from [Exercise 3: Selecting and Moving Labels](#) (page 755).

Examine label properties

NOTE This exercise uses *Labels-2b.dwg* with the modifications you made in the previous exercise.

- 1 On the command line, enter LIST.
- 2 On the West Street alignment, click a station label and a bearing over distance label. Press Enter.
The AutoCAD Text Window appears, displaying the object type, label type, and layer of the selected label objects.
For example, in AECC_ALIGNMENT_STATION_LABEL_GROUP
 - ALIGNMENT is the object type
 - STATION_LABEL indicates that it is a station label object
 - GROUP indicates that the label object is part of a label groupAECC_ALIGNMENT_TANGENT_LABEL is not followed by GROUP because it is an individual object label.
- 3 Close the AutoCAD Text Window.
Next, you will change the label style of an individual label object.

Change the style of a single label

- 1 Click the curve label near station 0+040. Right-click. Click Properties.
- 2 In the Properties palette, change the Curve Label Style to Curve Label Style ► Design Data.
- 3 Press Esc to deselect the label.

Change the style of a group of labels

- 1 Click station label 0+040.
All station labels are highlighted, indicating that they are part of a label group.
- 2 Right-click. Click Properties.

NOTE Selecting Edit Alignment Labels from the shortcut menu opens the Alignment Labels dialog box, where you can change the alignment label set.

- 3 In the Properties palette, under Labeling, change the Major Station Label Style to Perpendicular With Tick.
- 4 Press Esc.

Flip a label to the opposite side of the alignment

- 1 Ctrl+click geometry point label PC: 0+018.54.
- 2 In the Properties palette, examine the properties that are available. Under General, change the Flipped property to True. Close the Properties palette.
- 3 Press Esc to deselect the labels.

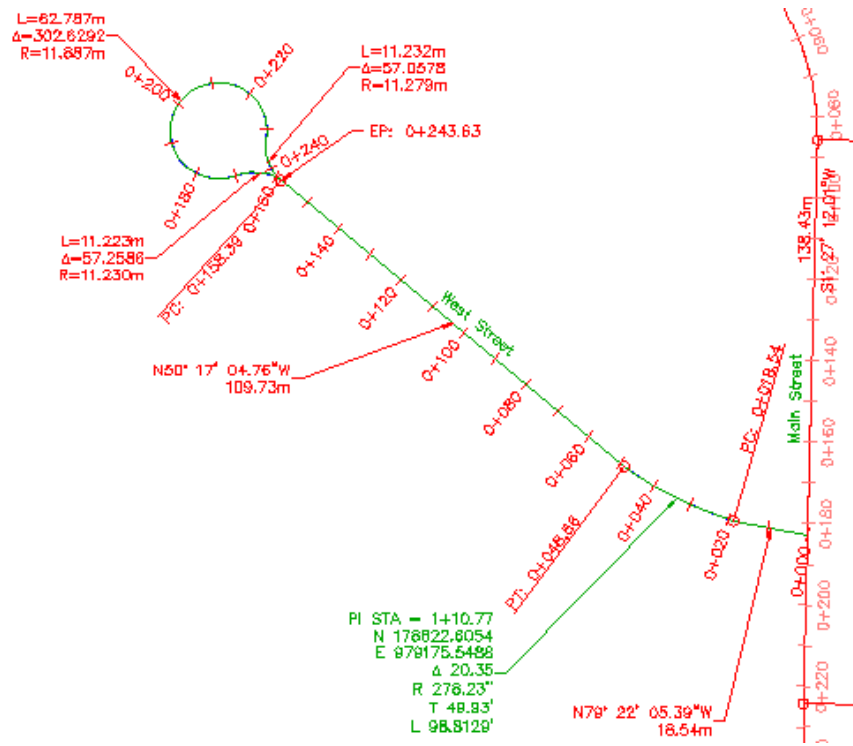

Alignment labels with modified properties

To continue to the next tutorial, go to [Changing the Content of a Label](#) (page 763).

Tutorial: Changing the Content of a Label

This tutorial demonstrates how to change label text content for an individual label and for a group of labels.

You will change the content of geometry point labels, which are part of a group of labels. You will override the text content of an individual label in a geometry point group. Then, you will change the geometry point abbreviation in the drawing settings, which will change the text content of all geometry point labels in the drawing.

For more information, see the AutoCAD Civil 3D Help topic *Adding Content to Labels*.

Exercise 1: Overriding Label Text

In this exercise, you will override the text in a single label. Label text overrides are useful for adding text to an individual label to mark a point of interest without modifying all labels that share a style.



For more information, see the AutoCAD Civil 3D Help topic *Overriding Label Text*.

Override the text of a label

NOTE This exercise uses *Labels-2b.dwg* with the modifications you made in the previous exercise, or you can open *Labels-3a.dwg* from the [tutorial drawings folder](#) (page 819).

- 1 Zoom and pan to the area between stations 0+000 and 0+100 of the Main Street alignment.
- 2 Ctrl+click the geometry point label PC: 0+035.99. Right-click. Click Edit Label Text.

NOTE Using Ctrl+click selects only one label in a group. For this exercise, you will override the text of only the PC: 0+035.99 label, and not the other geometry point labels.

- 3 In the Text Component Editor - Label Text dialog box, place your cursor at the end of the equation in the preview pane. Press Enter.
- 4 Enter N: in the preview pane.
- 5 In the Properties list, select Northing. Click  to move the Northing formula, then place your cursor at the end of the equation and press Enter.
- 6 Enter E: in the preview pane.
- 7 In the Properties list, select Easting. Click  to move the Easting formula. The formula in the preview pane should look like this:

```
<[Geometry Point Text(CP)]>: <[Station Value(Um|FS|P2|RN|AP|Sn|TP|B3|EN|WO|OF)]>  
N: <[Northing(Um|P4|RN|AP|Sn|OF)]>  
E: <[Easting(Um|P4|RN|AP|Sn|OF)]>
```

- 8 Click OK.

Notice that the label updates to show the Northing and Easting values at the point of curvature. The other labels at the points of curvature and tangency have maintained their original style settings. To apply this change to the entire group of geometry point labels, you would modify the style that is used by the entire group.

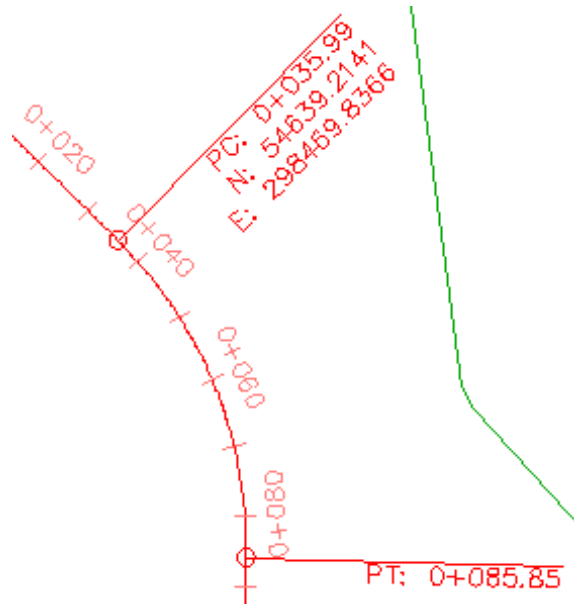

Geometry point label PC: 0+035.99 with overridden text

- 9 To return the label to its original style settings, Ctrl+click the label. Right-click. Click Clear Label Text Override.

To continue this tutorial, go to [Exercise 2: Changing Label Content in the Drawing Settings](#) (page 765).

Exercise 2: Changing Label Content in the Drawing Settings

In this exercise, you will change the default abbreviations that appear in geometry point labels.

For more information, see the AutoCAD Civil 3D Help topic *Understanding Settings*.

This exercise continues from [Exercise 1: Overriding Label Text](#) (page 764).

Change label content in the drawing settings

NOTE This exercise uses *Labels-3a.dwg* with the modifications you made in the previous exercise.

- 1 Zoom and pan to the area between stations 0+000 and 0+080 of the West Street alignment.
- 2 In Toolspace, on the Settings tab, right-click the drawing name. Click Edit Drawing Settings.
- 3 In the Drawing Settings dialog box, click the Abbreviations tab.

NOTE In the Drawing Settings dialog box, you can use the Object Layers tab to change the default layer on which AutoCAD Civil 3D objects and their labels are created.

The Alignment Geometry Point Text category lists the abbreviations currently in use for each type of geometry point.

- 4 In the Value column, change the geometry point abbreviation values to the following:
 - Alignment End: End
 - Tangent-Curve Intersect: Tan-Cur
 - Curve-Tangent Intersect: Cur-Tan
- 5 Click OK.

The geometry point labels update to reflect the change in the drawing settings.

NOTE If the abbreviations in the geometry point labels have not updated to reflect the changes you made, enter REGEN on the command line.

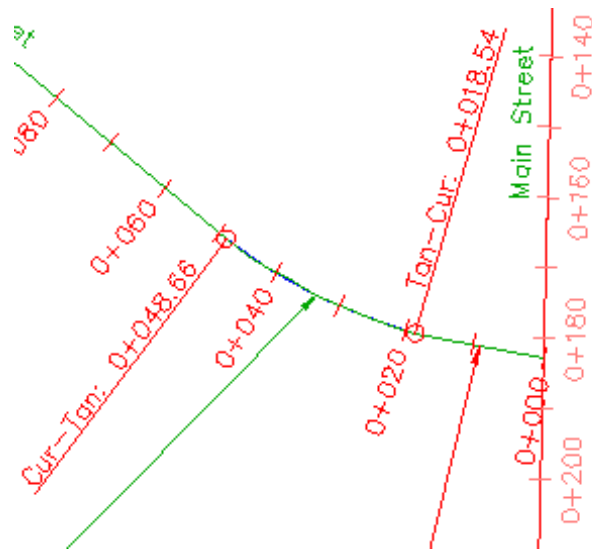

Geometry point labels with abbreviations modified in drawing settings

6 Close the drawing.

To continue to the next tutorial, go to [Working with Tables and Tags](#) (page 767).

Tutorial: Working with Tables and Tags

This tutorial demonstrates how to place object data into tables.

Each row in a table contains information about a single object component, such as a line or a curve. You can create tables for point, parcel, alignment, surface, pipe, and structure objects. However, only alignment and parcel tables can be created through Xref.

Some object label styles have two modes: label and tag. *Label* mode is the default label appearance when you annotate an object. *Tag* mode replaces the detailed label information with a short alphanumeric code so you can move the information into a table. Labels switch to tag mode automatically when a table is inserted into the drawing, using the style-based selection method.

The label styles for the following objects support tag mode:

- general lines and curves
- alignment lines, curves, and spirals
- parcel area, lines, and curves

For more information, see the AutoCAD Civil 3D Help topics *Setting Up Label Styles to be Used as Tags* and *Understanding Tables*.

Exercise 1: Creating a Parcel Area Table

In this exercise, you will create a table to display information about parcel objects.

You use a similar workflow to create tables for most AutoCAD Civil 3D objects. In this exercise, you will learn about the table tools in AutoCAD Civil 3D, and the dynamic nature of externally referenced drawings. You will add a parcel area table to an externally referenced drawing, and then examine the results in the host drawing.

To create a table for an object, the object must be labeled. Most tables require that you specify the table data by selecting a label style. In this exercise, you will select parcel area labels to create a parcel area table. However, the parcel and area labels exist in an externally referenced drawing. Parcel area tables cannot be created through xref, so you cannot create the table in the current drawing.

For more information, see the AutoCAD Civil 3D Help topic *Adding Tables to a Drawing*.

Apply a simpler parcel area label style

NOTE Before you begin this exercise, you must have the provided *Labels-* drawings saved in the [My Civil Tutorial Data folder](#) (page 819). See the [Attaching Drawings as Xrefs for Annotation exercise](#) (page 740) for more information.

- 1 Open *Labels-4a.dwg*, which is located in the [My Civil Tutorial Data folder](#) (page 819).
- 2 Open *Labels-Parcels.dwg*, which is located in the [My Civil Tutorial Data folder](#) (page 819).

- 3 In *Labels-Parcels.dwg*, zoom in so that you can see all of the parcels adjoining East Street, which is the cul-de-sac alignment on the right-hand side of the drawing.
You will apply a simpler area label style to parcels 37 through 41, and then create a table that will display detailed parcel data.
- 4 In Toolspace, on the Prospector tab, expand Sites ► Site. Click the Parcels collection.
- 5 In the item view at the bottom of Toolspace, use Shift+click to select parcels number 37 through 41. Right-click the Area Label Style column heading. Click Edit.
- 6 In the Select Label Style dialog box, select Parcel Number. Click OK.
The parcel area label consists of the parcel number only. In the following steps, you will create a table that displays detailed information about each of these parcels.

Create a parcel area table

- 1 Click Annotate tab ► Labels & Tables panel ► Add Tables menu ► Parcel ► Add Area.
- 2 In the Table Creation dialog box, in the Select By Label Or Style area, in the Parcel Number row, select the Apply check box.
You can select multiple styles from which to create the parcel table. All the parcels that use the selected styles will be shown in the table.
- 3 Click OK.
When you move the cursor into the drawing area, the upper left corner of the table is attached to the cursor.
- 4 Move the cursor to the right of the parcels and click.
The table is inserted into the drawing.
- 5 On the Quick Access toolbar, click  Save.
- 6 Close the Labels-Parcels drawing.

Examine the results in the current drawing

- 1 In drawing *Labels-4a*, on the command line, enter XREF.
- 2 In the External References palette, right-click Labels-Parcels. Click Reload.

The current drawing is rebuilt using the updated data from the *Labels-Parcels* drawing. Notice that the parcel area table you created in the externally referenced drawing is shown, and the parcels at the end of the East Street alignment use the Parcel Number area label style.

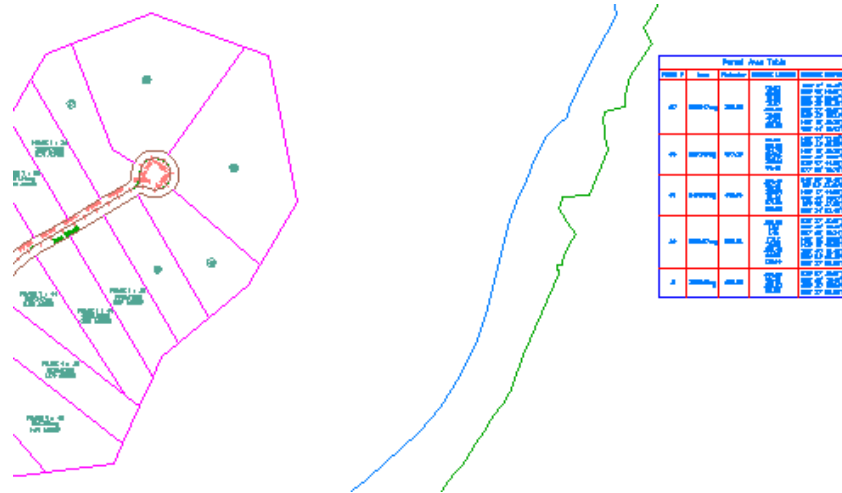

Parcel area table added to an externally referenced drawing

To continue this tutorial, go to [Exercise 2: Converting Labels to Tags](#) (page 770).

Exercise 2: Converting Labels to Tags

In this exercise, you will create some parcel segment labels, and then convert the labels to tags and move the data into a table.

In [Exercise 1: Creating a Parcel Area Table](#) (page 768), you created a table in the externally referenced *Labels-Parcels* drawing. In this exercise, you will create parcel segment labels directly in the current drawing. You will then convert the segment labels to tags and create a table to display the detailed label information.

For more information, see the AutoCAD Civil 3D Help topic *Setting Up Label Styles to be Used as Tags*.

This exercise continues from [Exercise 1: Creating a Parcel Area Table](#) (page 768).

Label the parcel segments

NOTE This exercise uses *Labels-4a.dwg* with the modifications you made in the previous exercise.

- 1 Click Annotate tab ► Labels & Tables panel ► Add Labels menu ► Parcel ► Add Parcel Labels .
- 2 In the Add Labels dialog box, specify the following parameters:
 - Label Type: Multiple Segment
 - Line Label Style: Parcel Line Label Style ► Bearing Over Distance
 - Curve Label Style: Parcel Curve Label Style ► Delta Over Length And Radius
- 3 Click Table Tag Numbering.
- 4 In the Table Tag Numbering dialog box, examine the settings that are available.

The settings specify the starting number and increment for line, curve, and spiral tags. Notice that there are separate starting number and increment properties for both Table Tag Creation and Table Tag Renumbering. For this exercise, accept the default value of 1 for all properties. When you convert the labels to table tags, they will all use a starting number and an increment of 1. You will use the Table Tag Renumbering properties later.
- 5 In the Table Tag Numbering dialog box, click Cancel.
- 6 In the Add Labels dialog box, click Add.
- 7 Click the parcel area labels in the following order: 39, 40, 41, 37, 38. Press Enter to accept the default Clockwise label direction.

As you click, labels are placed on each parcel segment. If you wish, zoom in to inspect the labels before you convert them to tags.

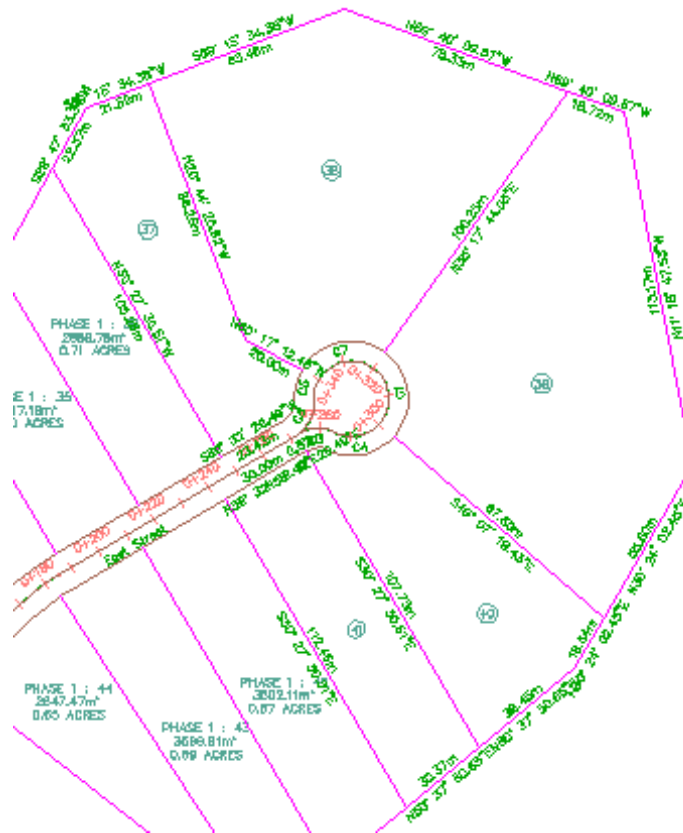

Parcel segment labels

- 8 When you finish labeling parcels, right-click to end the command.
The Add Labels dialog box remains open, in case you want to label more parcels or other objects. You can close it, as you will not use it again in this exercise.

Place the segment labels in a table

- 1 Click Annotate tab ► Labels & Tables panel ► Add Tables menu ► Parcel ► Add Segment.
This option creates a table that shows both the line and curve segments of the labeled parcels.

- 2 In the Table Creation dialog box, in the Select By Label Or Style area, select the Apply check box for the two label styles you placed on the parcel segments:
 - Parcel Curve: Delta Over Length And Radius
 - Parcel Line: Bearing Over Distance
- 3 Click OK.
When you move the cursor into the drawing, the upper left corner of the table is attached to the cursor.
- 4 Move the cursor outside the surface extents and click.
The table is inserted into the drawing. Notice that the line and curve labels around the parcels have been converted to tags.

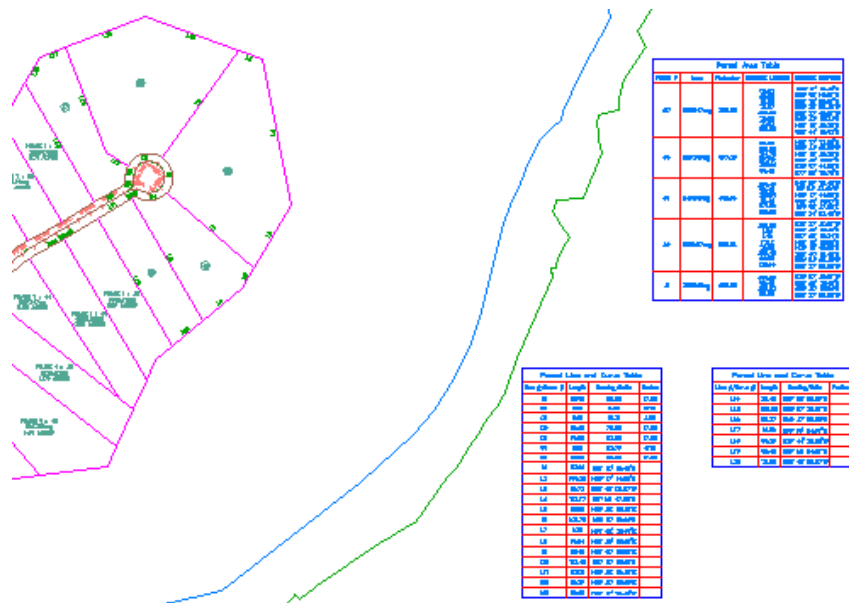

Parcel segment labels converted to tags, with a parcel segment table added to drawing

To continue this tutorial, go to [Exercise 3: Renumbering Table Tags](#) (page 774).

Exercise 3: Renumbering Table Tags

In this exercise, you will renumber the table tags you created in the previous exercise.

You will renumber the curve table tags around the cul-de-sac on the East Street alignment so that they follow a clockwise pattern. You will use the Table Tag Numbering dialog box that you examined in the previous exercise to specify the starting number and increment with which to renumber the table tags.

For more information, see the AutoCAD Civil 3D Help topic *Renumbering Label Tags*.

This exercise continues from [Exercise 2: Converting Labels to Tags](#) (page 770).

Examine the table tag numbering settings

NOTE This exercise uses *Labels-4a.dwg* with the modifications you made in the previous exercise, or you can open *Labels-4b.dwg* from the [tutorial drawings folder](#) (page 819).

- 1 In Toolspace, on the Settings tab, right-click the drawing name. Click Table Tag Numbering.
- 2 In the Table Tag Numbering dialog box, notice that the Table Tag Creation Starting Number values are not 1 as they were [Exercise 2: Converting Labels to Tags](#) (page 770).

The Starting Number values are the next available numerals based on the line, curve, and spiral tags that exist in the drawing and the specified increment value. If you add more table tags in the drawing, these values prevent the duplication of tag numbers.

NOTE The Table Tag Numbering dialog box specifies the tag numbering settings for all objects. The settings that you specify in the following steps will apply to table tags for all objects.

- 3 Under Table Tag Renumbering, accept the default values.
For this exercise, you will restart the curve numbering at 1 and use an increment of 1.
- 4 Click OK.

Renumber the table tags

- 1 In the drawing, zoom in to the area around the cul-de-sac at the end of the East Street alignment.
- 2 Click a label tag to select it. Click Labels tab ► Modify panel ► Renumber Tags.
- 3 Click tag C6.
You are notified that tag number 1 already exists. If you press Enter, the next available curve tag will be applied to this tag. For this exercise, a duplicate tag is acceptable, because you will continue the renumbering to resolve duplicates.
- 4 On the command line, enter C to create a duplicate curve table tag.
The curve table tag now appears as C1.
- 5 Press Esc.
- 6 Repeat steps 3 through 5 on the remaining curve table tags, so that the curve table tags are labeled C1 through C7 clockwise around the cul-de-sac.

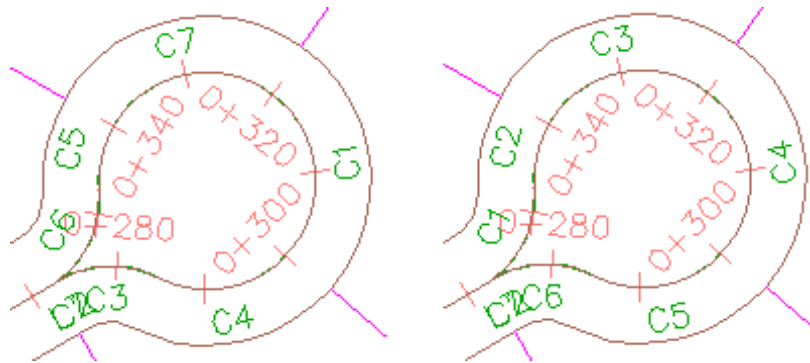

Table tags: original (left) and renumbered (right)

- 7 Pan to the parcel line and curve table you created in [Exercise 2: Converting Labels to Tags](#) (page 770).
Notice that the table has automatically updated to reflect the new curve numbering.
Further exploration: Add segment labels to the rest of the parcels along the East Street alignment, and then convert the labels to table tags.

Renumber the table tags along the right-of-way so that they follow a clockwise pattern.

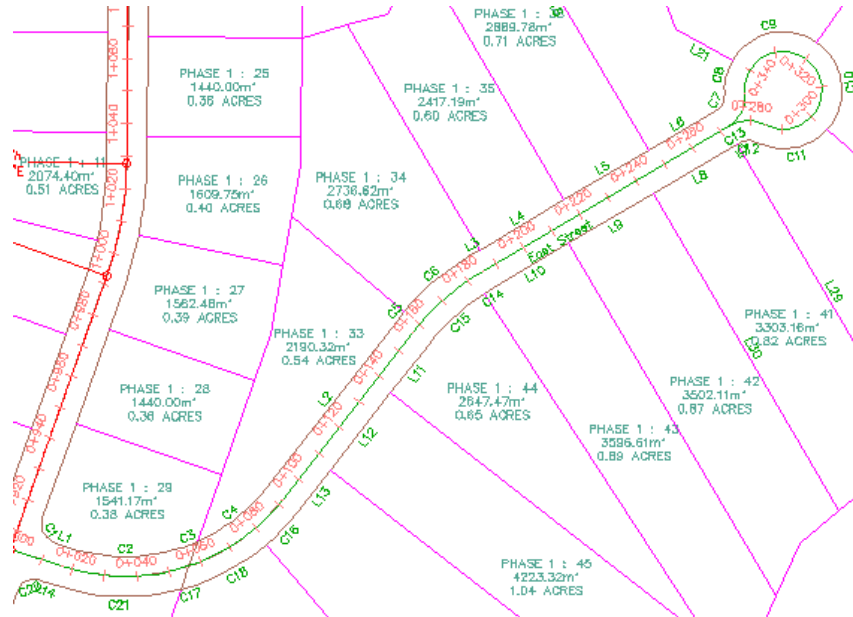

Table tags renumbered along right-of-way

To continue to the next tutorial, go to [Working with Label Styles](#) (page 776).

Tutorial: Working with Label Styles

This tutorial demonstrates how to define the behavior, appearance, and content of labels using label styles.

Like other AutoCAD Civil 3D objects, every label in a drawing has a style associated with it. If you edit a label style, changes are immediately reflected in all labels in the drawing that use that style.

For more information, see the AutoCAD Civil 3D Help topic *Creating and Editing Label Styles*.

Exercise 1: Creating a Label Style

In this exercise, you will create a label style.

In most cases, the easiest way to create a style is to find an existing style that is similar to the format that you want, create a copy, and then modify the copy.

In the following steps, you will create a design speed label style. You will learn various ways to create and edit label styles using the AutoCAD Civil 3D Toolspace.

For more information, see the AutoCAD Civil 3D Help topic *Creating New Label Styles*.

To create a label style



NOTE This exercise uses *Labels-4b.dwg* with the modifications you made in the previous exercise, or you can open *Labels-5a.dwg* from the [tutorial drawings folder](#) (page 819).



- 1 Zoom in to station 0+000 of the Main Street alignment.
Examine the design speed label. You will use this label style as a basis to create a new label style that will display the design speed without the station label. The design speed labels will be placed at locations where the stations are already labeled.

NOTE Design speed information, including the station at which the design speed has been applied, is available in the Alignment Properties dialog box on the Design Speeds tab.

- 2 Select the design speed label. Right-click. Select Edit Alignment Labels.
- 3 In the Alignment Labels dialog box, in the Design Speeds row, in the Style column, click .

NOTE You use the Alignment Labels dialog box to create and edit label sets or to import an existing label set.

- 4 In the Pick Label Style dialog box, click the arrow next to . Click  Create New.

NOTE The  Create Copy selection uses the format of the current style as a basis for the new style. You will learn about the  Create Child Of Current Selection option in [Exercise 2: Using a Child Label Style](#) (page 780).

- 5 In the Label Style Composer dialog box, on the Information tab, specify the following parameters:
 - Name: Design Speeds - Inline
 - Description: Small design speed label perpendicular to the alignment
- 6 Click the General tab.

On the General tab, you can specify the settings for the overall label style, including the visibility, layer, and plan readability. For this exercise, accept the default settings on this tab. You can turn on or off the visibility of the individual label components on either the Summary or Layout tab.
- 7 Click the Layout tab.

On the Layout tab, you specify the content of the label style. A label can be made up of one or more components, each of which can have separate properties.
- 8 Examine the contents of the Component Name list.

Each component is shown in the Preview pane on the right side of the dialog box. You can use the buttons to the right of the Component Name list to create, copy, or delete label style components. These components were copied when you created the style from the existing Station Over Speed style.
- 9 In the Component Name list, select Station. In the General collection, change the Visibility to False.

Notice that your change is shown immediately in the Preview pane. This pane is useful when you are designing a label style. If you do not like what you see in the preview, you can change it before saving the style.

NOTE To delete the Station component, select it from the Component Name list, and then click  .

- 10 In the Component Name list, select Design Speed. Specify the following parameters:

General

 - Anchor Component: Line
 - Anchor Point: End

Text

- Attachment: Bottom Right
- X Offset: 0.0 mm
- Y Offset: 1.0 mm

- 11 In the Text collection, for the Contents property, click the Value column.

Click .

You can use the Text Component Editor dialog box to define the content and format of a label style text component. The Properties list displays the available properties that can be displayed in a label component. When you select a component from the list, the applicable values are displayed in the table below.

- 12 In the Text Component Editor dialog box, in the preview pane, select the DESIGN text. Press Delete.
- 13 Click the <[Design Speed(P3|RN|Sn|OF|AP)]> property block.
After you have selected the property block in the Preview pane, you can modify the specific values that will be applied to the property.
- 14 In the Properties list, select Design Speed. Change the Precision value to 0.1. Click  to apply the new Precision value to the block in the Preview pane.
Notice that in the block of code, P0 has changed to P1.
- 15 In the Preview pane, select the SPEED text.
- 16 Click the Format tab.
You can change the style, justification, font, and color of each text component.
- 17 With the text in the Preview pane selected, change the Font to Times New Roman. Click OK.
In the Label Style Composer, notice that the SPEED font is different from the design speed value. The design speed value font did not change because it was not selected when you changed the font.
- 18 Click OK to close the Label Style Composer, Pick Label Style, and Alignment Labels dialog boxes. Pan along the Main Street alignment to view the format of the new label style.

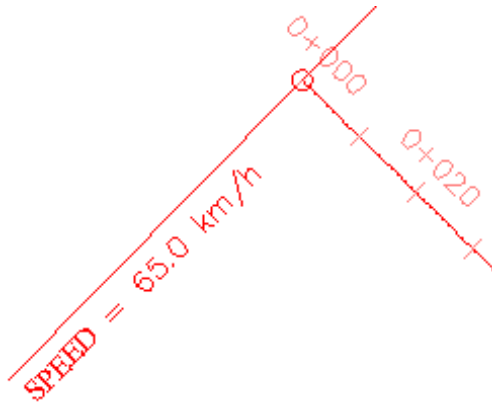

Label style created from an existing style

To continue this tutorial, go to [Exercise 2: Using a Child Label Style](#) (page 780).

Exercise 2: Using a Child Label Style

In this exercise, you will create a child label style that derives its default settings from an existing label style, or parent.

In the following steps, you will create a child of an existing alignment label style, and modify some of the child label style properties. You will examine the results, and then override some of the child style properties with those of the parent label style.

For more information, see the AutoCAD Civil 3D Help topic *Modifying Labels in a Drawing*.

This exercise continues from [Exercise 1: Creating a Label Style](#) (page 776).



Create a child label style

NOTE This exercise uses *Labels-5a.dwg* with the modifications you made in the previous exercise.

- 1 Pan to station 0+080 on the West Street alignment.
- 2 Ctrl+click the station label 0+080. Right-click. Click Label Properties.
- 3 In the Properties palette, on the Design tab, click the value for Major Station Label Style. Select Create/Edit from the list.

- 4 In the Label Style dialog box, change the style to Perpendicular With Line.

NOTE Make sure that you select Perpendicular With Line, and not Perpendicular With Tick.

- 5 Click the arrow next to . Click  Create Child Of Current Selection.
- 6 In the Label Style Composer, on the Information tab, change the style name from Perpendicular With Line [Child] to Station Emphasis.
- 7 On the Layout tab, under Component Name, select Station.
- 8 Under Text specify the following parameters:
 - Text Height: 5.00mm
 - Attachment: Middle Left

- 9 Click OK twice.

The station is now displayed in large text that is attached to the end of the line. The size and position of the text are properties of the new style, Station Emphasis. The contents of the text, and the color and length of the line are properties of the parent style, Perpendicular With Line.

- 10 Press Esc to deselect the label.

- 11 In the drawing, Ctrl+click the label 0+100. Change its style to Perpendicular With Line, using the Properties palette.

Notice that in the style collection displayed in the Properties palette, the new style is indented under its parent. You can also see this placement in Toolspace, on the Settings tab, under Alignment ► Label Styles ► Station ► Major Station ► Perpendicular With Line.

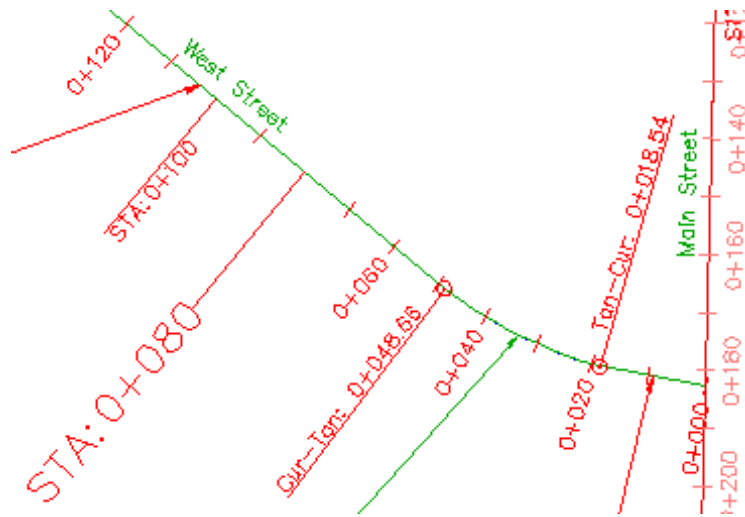

Parent (STA: 0+100) and child (STA: 0+080) label styles

Notice that in the drawing, the STA:0+080 and STA:0+100 label text are different sizes, and the text and line are aligned differently. A child style shares its basic properties with the parent style from which it was created. If a property value changes in the parent style, then the change is also applied to the child style. If a property value changes in the child style, the parent style is not affected.

By creating a child style, you have created the station display you need, without affecting other parts of the drawing. If you had instead changed the properties of the parent style, it would have automatically changed the appearance of any other major stations using that style.

Next, you will set the parent style to override the text setting in the child style.

Override the child label style

- 1 In Toolspace, on the Settings tab, expand the Alignment ► Label Styles ► Station ► Major Station collections.
- 2 Right-click Perpendicular With Line. Click Edit.
- 3 In the Label Style Composer dialog box, click the Summary tab.
- 4 Expand the Component 1 property.

5 In the Text : Text Height row, click  in the Child Override column.

In the Child Override column,  is displayed, indicating that the previously independent property of the child has been overridden by the parent.

6 Click OK.

Notice that the labels now use the same text size. The STA: 0+080 label text is now the same size as the STA: 0+000 label because the text height of the parent style has overridden that of the child style. The alignment of the line is still different because the text attachment point of the child style was not overridden.

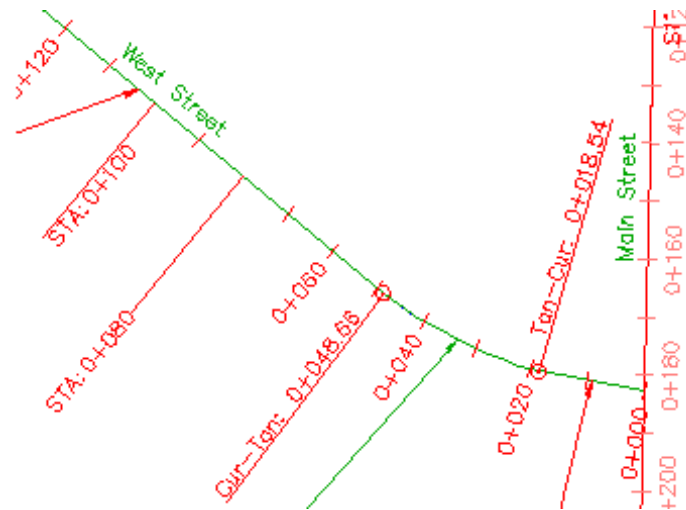

Parent (STA: 0+100) and child (STA: 0+080) label styles, with child text size overridden by parent

To continue this tutorial, go to [Exercise 3: Controlling Label Appearance Using Layers](#) (page 783).

Exercise 3: Controlling Label Appearance Using Layers

In this exercise, you will use layers to change the color and visibility of labels.

The components that make up a label object get their color, line weight, and line type property settings from either the label style or the layer to which

the label style refers. When a label style refers to a specific layer, any label style components that are set to either ByLayer or ByBlock inherit the properties of that specific layer. However, if the label style refers to layer 0, then any label style components that are set to either ByLayer or ByBlock inherit their properties from the layer on which the label resides.

A label is an independent AutoCAD Civil 3D object that can be on a separate layer from its parent object. However, the visibility of a label is linked to the layer of the parent object. Turning off or freezing the layer of an object also hides the labels of that object, even if they reside on a different layer.

For more information, see the AutoCAD Civil 3D Help topics *Managing General Properties for Label Styles* and *Managing Layout Properties for Label Styles*.

This exercise continues from [Exercise 2: Using a Child Label Style](#) (page 780).

Examine how parent object layer state affects label visibility

NOTE This exercise uses *Labels-5a.dwg* with the modifications you made in the previous exercise, or you can open *Labels-5b.dwg* from the [tutorial drawings folder](#) (page 819).

- 1 On the West Street alignment, zoom and pan to the area between stations 0+100 and 0+120.
- 2 Click station label 0+120 to select all major station labels. Right-click. Click Properties.
On the Properties palette, notice that the alignment station labels are on layer C-ROAD-TEXT. If you look at the properties for the alignment itself, you will see that it is on the C-ROAD layer.
- 3 Click Home tab ► Layers panel ► Layer list. Next to the C-ROAD layer, click  to turn off the C-ROAD layer.
- 4 On the command line, enter REGEN.
The alignment and its labels are hidden. This happened because, while labels are independent objects on a separate layer, their visibility is linked to the layer of the parent object, C-ROAD. Turning off the layer of an object also hides the labels of that object, even if they reside on a different layer.

NOTE The blue line that remains in place of the alignment is the polyline in the externally referenced drawing, from which you created the alignment in the [Adding Labels In Groups](#) (page 745) exercise.

- 5 Click Home tab ► Layers panel ► Layer list. Next to the C-ROAD layer, click  to turn on the C-ROAD layer and the station labels.
- 6 On the command line, enter REGEN.

Create a label style that is not affected by the parent object layer

- 1 Select label 0+120 to select all major station labels. On the Properties palette, under Labeling, click the field next to Major Station Label Style. Click Create/Edit.

- 2 In the Major Station Label Style dialog box, click  Edit Current Selection.

In the Label Style Composer dialog box, on the General tab, in the Label category, notice that the Layer is 0. If a label style is set to layer 0, any of its color, line type, and line weight properties that are set to ByLayer or ByBlock will inherit the corresponding properties of the layer on which the label resides.

- 3 Click the Layout tab.

In the Text category, notice that the Color property for the Station component is ByLayer. This means that the major station label text inherits the color of the layer to which the style refers. Because the label style refers to layer 0, the major station label text inherits the color of the label object layer, which is C-ROAD_TEXT.

- 4 In the Color row, click the Value cell. Click  and change the Station component color to blue.

Notice that the text color updates in the Preview pane.

NOTE For greater control of color, lineweight, and linetype, keep all style components set to either ByBlock or ByLayer, and the label style layer set to 0. Then, you can use the layers to modify these properties. This tutorial uses a specific color setting to demonstrate how layer settings affect styles.

- 5 In the Component Name list, select Tick.
In the Tick category, notice that the Color property for the Tick component is ByLayer.
- 6 Click OK to apply the change in color to the Major Station component and exit the Label Style Composer and Major Station Label Style dialog boxes.

- 7 Press Esc to deselect the labels.
- 8 On the command line, enter REGEN.
Notice that while the ticks still inherit the red color from the C-ROAD-TEXT layer, the text is blue.

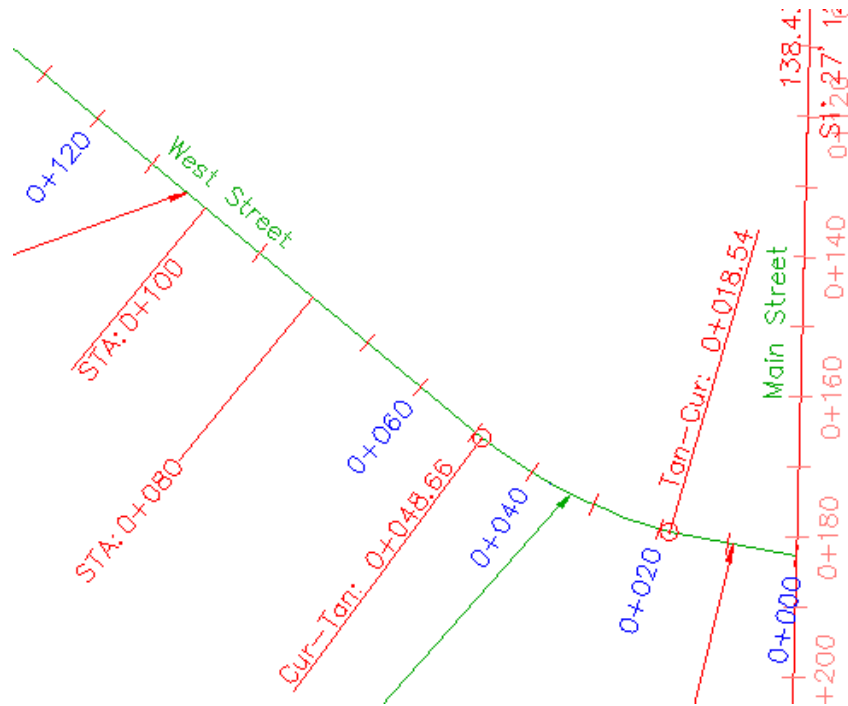

Label style that uses color that differs from referenced layer

Add another label

- 1 Click Annotate tab ► Labels & Tables panel ► Add Labels menu ► Alignment ► Single Segment .
- 2 When prompted to select a segment to label, click the alignment between stations 0+060 and 0+080. When a label appears on the alignment, press Enter to end the command.

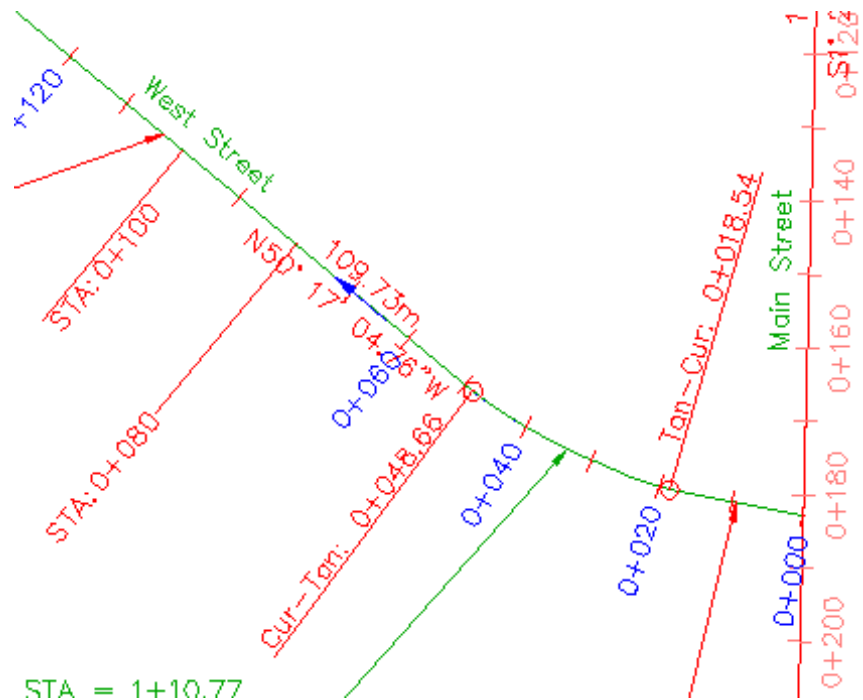

Segment label added to alignment

- 3 Select the new label. On the Properties palette, notice that the label is on C-ROAD-TEXT.

When labels are created, they are placed on the layer specified for the label object in the Drawing Settings dialog box on the Object Layers tab. The drawing settings for this drawing specify that alignment labels are created on the C-ROAD-TEXT layer. For more information, see the AutoCAD Civil 3D Help topic *Specifying Object Layer Settings*.

- 4 On the Properties palette, click the field next to Line Label Style. Click Create/Edit.

- 5 In the Line Label Style dialog box, click  Edit Current Selection.

In the Label Style Composer dialog box, on the General tab, in the Label category, notice that the layer style is C-ROAD-BRNG. This means that if any of the color, line type, and line weight properties are set to ByLayer or ByBlock, they inherit the corresponding properties of the C-ROAD-BRNG layer, no matter what layer the label object is on.

- 6 Click the Layout tab.

Use the Component Name list to examine the properties of the various label components. Notice that the Color of all the components is ByLayer, except for the Direction Arrow component.

The label components that have their Color property set to ByLayer are red because the color property of the C-ROAD-BRNG layer is red. The direction arrow is blue because its Color property is blue.

- 7 Click Cancel to exit the Label Style Composer and Line Label Style dialog boxes.

Examine the affects of layer visibility on the labels

- 1 Click Home tab ► Layers panel ► Layer list. Next to the C-ROAD-TEXT layer, click  to turn off the C-ROAD-TEXT layer.

The major station labels and ticks are hidden, but the tangent label you added is not. The station labels were hidden because they are on the C-ROAD-TEXT layer and their style refers to the C-ROAD-TEXT layer, which you turned off. The tangent label is still visible because, while you turned off the layer it is on, its style components refer to the C-ROAD-BRNG layer, which is still visible.

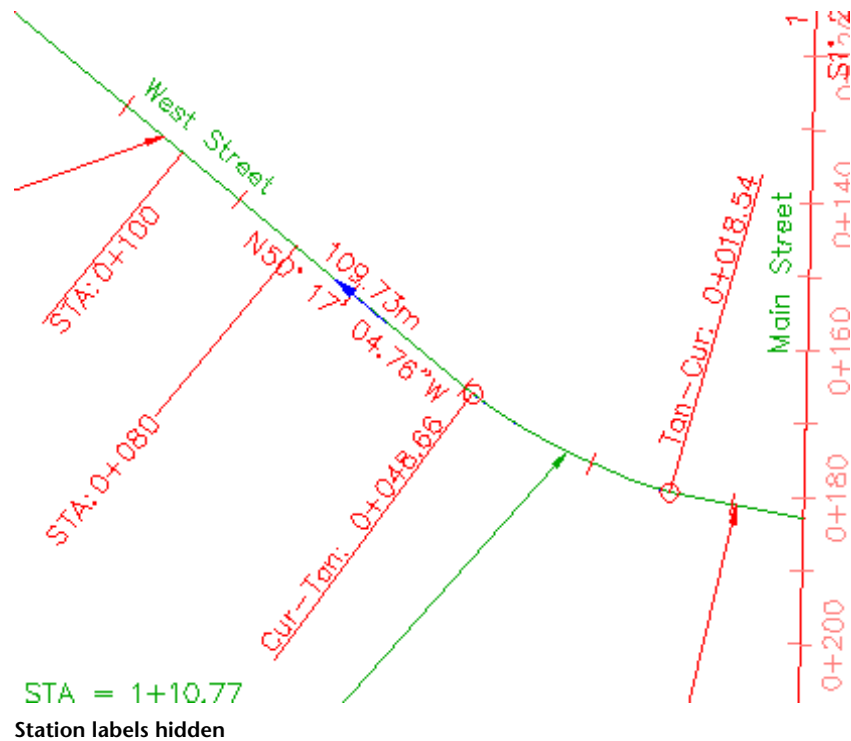

Notice that the STA:0+080 and STA:0+100 labels you changed in [Exercise 2: Using a Child Label Style](#) (page 780) are also still visible. This is because the rest of the major station labels use the Perpendicular With Tick style, which refers to layer 0. Labels STA=0+060 and STA=0+080 use the Perpendicular With Line and Station Emphasis styles, which refer to the C-ROAD-LABL layer.

- 2 Click Home tab ► Layers panel ► Layer list. Next to the C-ROAD-TEXT layer, click  to turn on the C-ROAD-TEXT layer and the station labels.

To continue this tutorial, go to [Exercise 4: Changing the Dragged State of a Label](#) (page 789).

Exercise 4: Changing the Dragged State of a Label

In this exercise, you will modify a label style so that a label will display differently when it is dragged from its original location.

Every label style has two default formats: one for when the label is initially created in its normal layout location, and another that is applied when you drag the label away from its normal layout location. The controls for editing the dragged state of a label style are similar to those used for the layout state.

For more information, see the AutoCAD Civil 3D Help topic *Managing Dragged Properties for Label Styles*.

This exercise continues from [Exercise 3: Controlling Label Appearance Using Layers](#) (page 783).

Drag a label from its original location

NOTE This exercise uses *Labels-5b.dwg* with the modifications you made in the previous exercise.

- 1** Zoom in so that you can see the 0+040 station label on the West Street alignment. Click the label to select it and all the other major station labels.
- 2** Click the grip and drag it away from the alignment.
The label is now in its dragged state. The text and leader line are red because the dragged state of the label style is set to ByLayer. Keep this label in view so you can see the effects of format changes as you make them.

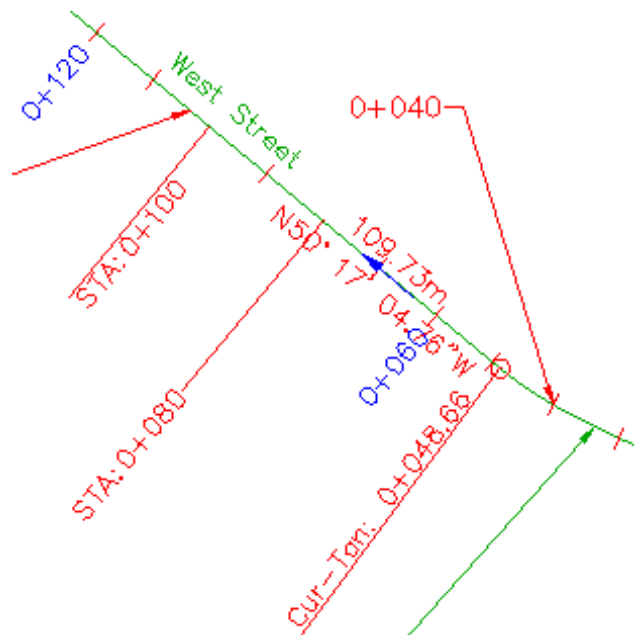

Major station label 0+040 in dragged state

Change the dragged state of the label

- 1 In Toolspace, on the Settings tab, expand Alignment ► Label Styles ► Station ► Major Station. Right-click Perpendicular With Tick. Click Edit.
 - 2 In the Label Style Composer dialog box, click the Draggged State tab.
In both the Leader and Draggged State Components categories, notice that the Color, Linetype, and Lineweight properties are all either ByLayer or ByBlock. These settings indicate that when a label is in dragged state, it inherits these properties from either the layer on which the label resides or the block that contains it.
-
- TIP** Because the Preview pane does not show the dragged state of the label, position the Label Style Composer so that you can see a dragged-state label in the drawing. Each time you change a label property, you can click Apply to see the effects.
-
- 3 In the Draggged State Components area, change the Display value to As Composed. Click Apply.

The label returns to the original layout property settings, and all other style controls in this area are disabled. This type of dragged-state format is easy to apply, but is not suitable for all label types. In particular, note that the leader line does not adapt well to all possible dragged locations.

- 4 Change the Display value back to Stacked Text. Click Apply.
If your label has multiple lines of text, the Stacked Text setting keeps them all stacked horizontally in a compact block. You can see this in action by dragging one of the curve labels from its layout location.
- 5 Change each of the following property values. Click Apply after each change to see their effects.
 - Leader Type: Spline Leader
 - Border Visibility: True
 - Border Type: Rounded Rectangular
 - Border and Leader Gap: 2.0mm
 - Leader Attachment: Top Of Top Line
- 6 After you have applied all the changes that you want to see in the dragged state, click OK.

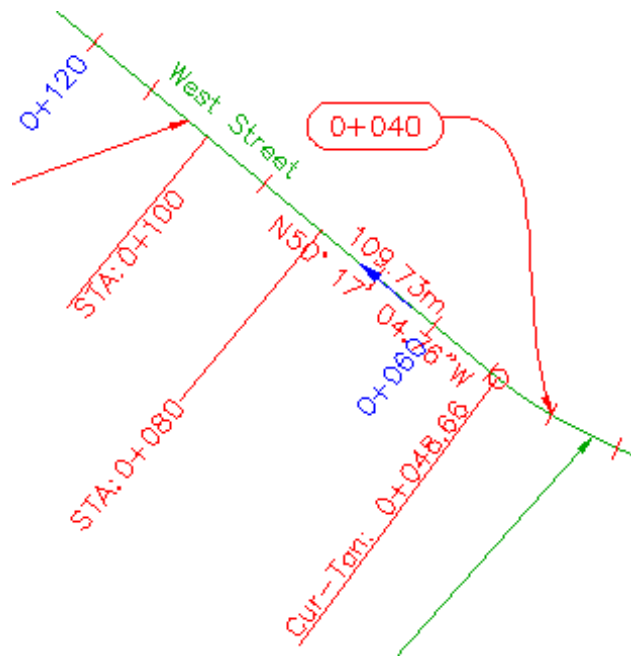

Modified dragged state: major station label 0+040

NOTE To return a dragged label to its original layout format, click the  grip.

To continue this tutorial, go to [Exercise 5: Changing a Label Style](#) (page 793).

Exercise 5: Changing a Label Style

In this exercise, you will learn several ways to change label styles.

Depending on the type of label type you must change, and how many labels of that label type you must change, you can change label styles at the following levels:

- Single label objects, including alignment curve and tangent labels.
- Groups of label objects, including alignment station and geometry point labels.

- Individual label objects that are part of a group, such as a single alignment station label.
- Individually labeled objects in the Prospector list view, including parcels, points, and pipe network objects.
See [Exercise 1: Creating a Parcel Area Table](#) (page 768) for information about changing parcel area label styles using the Prospector list view.

For more information, see the AutoCAD Civil 3D Help topic *Modifying Labels in a Drawing*.

This exercise continues from [Exercise 4: Changing the Dragged State of a Label](#) (page 789).

Change the label style of a single label object

NOTE This exercise uses *Labels-5b.dwg* with the modifications you made in the previous exercise, or you can open *Labels-5c.dwg* from the [tutorial drawings folder](#) (page 819).

- 1 Pan and zoom to the area at the end of the West Street cul-de-sac.
- 2 Click the red curve label between stations 0+200 and 0+220 on West Street.
Grips appear on the curve label, but no other labels are selected. This label is a single label object that is not part of a group of labels.
- 3 Right-click the label. Click Properties.
- 4 On the Properties palette, in the Curve Label Style list, notice that you can select a General Curve Label Style. General styles can be applied to line and curve labels that annotate alignment, profile, or parcel segments. Select General Curve Label Style ► Radius Only.
The individual curve label style changes, but the remaining curve labels on the cul-de-sac are not affected.
- 5 Press Esc to deselect the label.

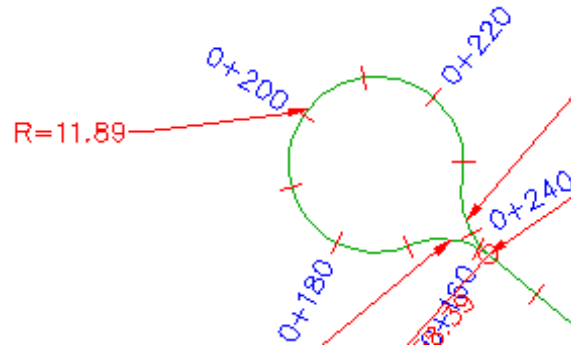

Curve label style changed

Change the label style of a group of label objects

- 1 Click the 0+220 station label.
Grips appear on all the station labels, indicating that station label 0+220 is part of the station label group.
- 2 Right-click the label. Click Properties.
- 3 On the Properties palette, in the Major Station Label Style list, select Parallel With Tick.
The label style changes for all major station labels on West Street.
- 4 Press Esc to deselect the major station labels.

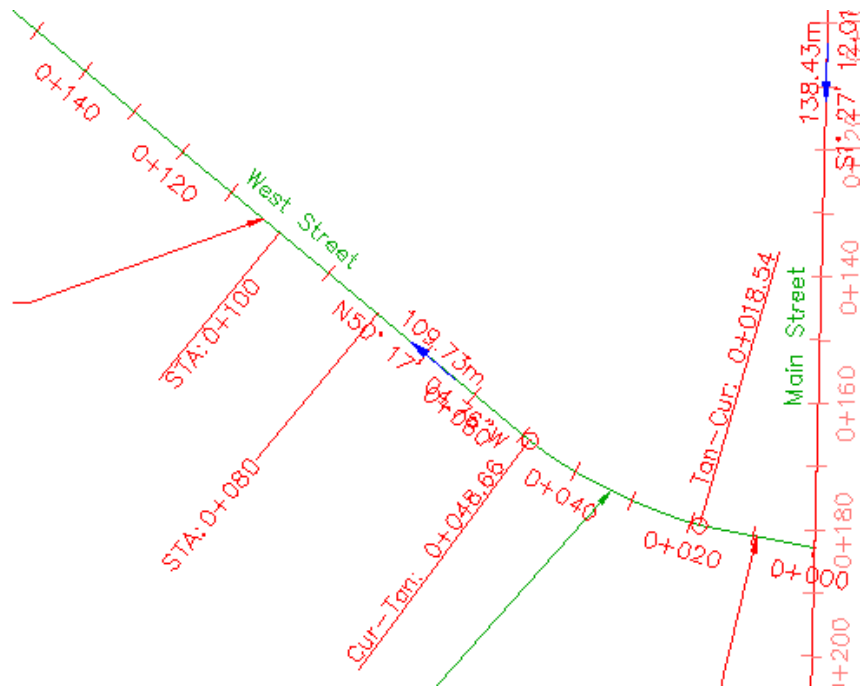

Major station label type group style changed

Change the label style of an individual label object that is part of a group

- 1 Ctrl+click the 0+060 station label.
A grip appears only on label 0+060. The other major station labels are not selected.
- 2 Right-click the label. Click Properties.
- 3 On the Properties palette, in the Major Station Label Style list, select Perpendicular With Line.
The label style changes for only station label 0+060. The rest of the major station labels on West Street retain their current style.
- 4 Press Esc to deselect the label.

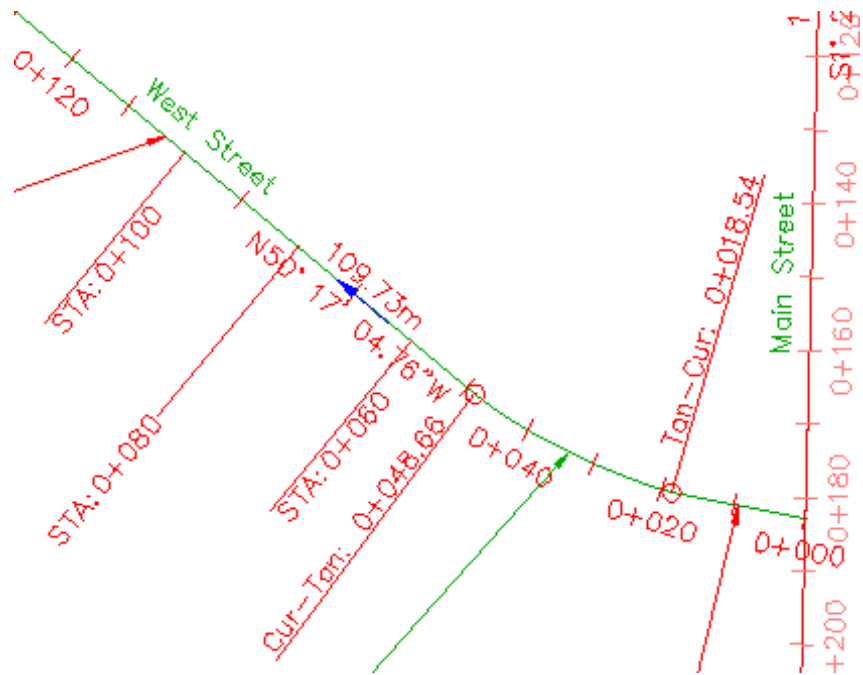

Major station label type style changed: STA: 0+060 only

To continue this tutorial, go to [Exercise 6: Creating a Label Style that Refers to Another Object](#) (page 797).

Exercise 6: Creating a Label Style that Refers to Another Object

In this exercise, you will use the reference text component to create a single label style that annotates two objects of different types.

The Reference Text label component is used to annotate multiple types of objects with a single label. You can insert references to surfaces, profiles, parcels, and alignments. Each reference text component can refer to only one AutoCAD Civil 3D object. If you need a label style to refer to several objects, create a separate reference text component for each referenced object.



In this exercise, you will create a label style that displays the alignment station and surface elevation at each horizontal geometry point.



For more information, see the AutoCAD Civil 3D Help topic *Referenced Text*.

This exercise continues from [Exercise 5: Changing a Label Style](#) (page 793).

Create a label style that refers to another object

NOTE This exercise uses *Labels-5c.dwg* with the modifications you made in the previous exercise.

- 1 In Toolspace, on the Settings tab, expand the Alignment ► Label Styles ► Station ► Geometry Point collection. Right-click Perpendicular With Tick And Line. Click Copy.
- 2 In the Label Style Composer dialog box, on the Information tab, for Name, enter Surface Elevation at Alignment Station.
- 3 Click the Layout tab.
You can use this tab to create and edit label style components. You will modify the existing line and geometry point components, and then create two new label components for the new label style. The first component will display the surface elevation, and the second component will display the alignment station.
- 4 Under Component Name, select Line. Specify the following parameters:
 - Start Point Anchor Component: Tick
 - Start Point Anchor Point: Middle Center
 - Length: 15.00mm
- 5 Under Component Name, select Geometry Point & Station. Specify the following parameters:
 - Anchor Component: Line
 - Anchor Point: End
 - Attachment: Middle Left
 - X Offset: 2.00mm
- 6 Click the arrow next to . Click  Reference Text.
A reference text label component refers to other object types in the drawing, instead of to the object type you are labeling. In this case, the reference text component will refer to a surface object.

- 7 In the Select Type dialog box, select Surface. Click OK.
- 8 In the Label Style Composer dialog box, specify the following parameters:
 - Name: Elevation
 - Anchor Component: Geometry Point & Station
 - Anchor Point: Bottom Left
 - Attachment: Top Left
- 9 Under Text, in the Contents row, click the Value cell. Click .
- 10 In the Text Component Editor dialog box, in the preview pane, replace Label Text with EL:. Under Properties, select Surface Elevation. Click  to move the Surface Elevation property to the preview pane. The property block in the preview pane should look like this:
EL: <[Surface Elevation(Um|P3|RN|API|Sn|OF)]>
- 11 Click OK.
- 12 In the Label Style Composer dialog box, click the General tab. Set the Flip Anchors With Text property to True. Using this setting ensures that when the labels are flipped to maintain plan readability, they will display as mirror images of the original labels.
- 13 In the Label Style Composer dialog box, click OK.

To apply the label style that refers to another object

- 1 In the drawing, pan to the intersection of the Main Street and East Street alignments.
- 2 Click Annotate tab ► Labels & Tables panel ► Add Labels menu ► Alignment ► Add/Edit Station Labels . Click one of the station labels on the East Street alignment.
- 3 In the Alignment Labels dialog box, specify the following parameters:
 - Type: Geometry Points
 - Geometry Point Label Style: Surface Elevation At Alignment Station
- 4 Click Add.

- 5 In the Geometry Points dialog box, click  to clear all check boxes. Select the Alignment Beginning check box. Click OK.
- 6 In the Alignment Labels dialog box, click OK.
- 7 Drag the label to a clear location, if necessary.
Notice that the label is added to the alignment, but the elevation value is displayed as ???. These characters are displayed because you have not associated a surface with the Elevation component.

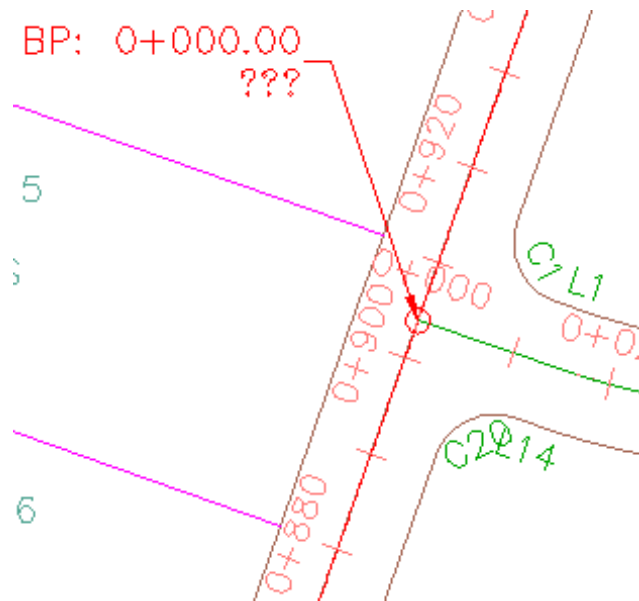

Label style that refers to an alignment and surface, with no surface associated with the label

- 8 Ctrl+click the Surface Elevation At Alignment Station label. Right-click. Click Label Properties.
- 9 In the Properties palette, under Reference Text Objects, click the cell to the right of Surface Elevation At Alignment Station. Click .
- 10 In the drawing, click the green surface border. Press Esc to deselect the label.
Examine the label. The surface elevation at the intersection of the alignments is now displayed.

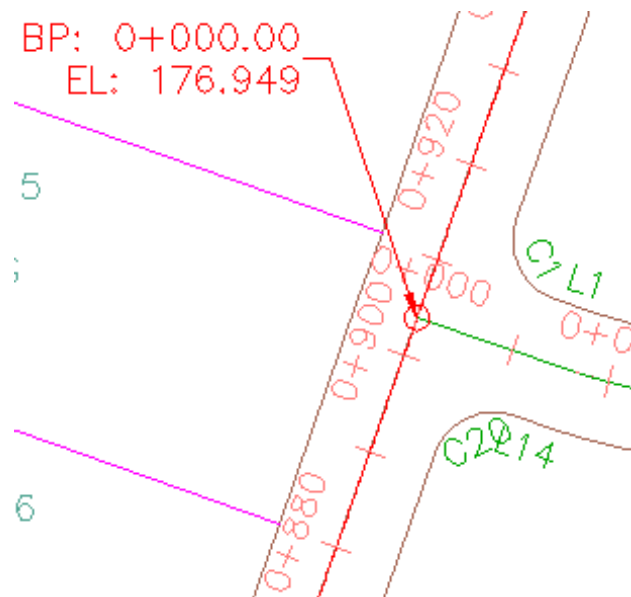

Label style that refers to an alignment and surface

To continue to the next tutorial, go to [Using Expressions in Labels](#) (page 801).

Tutorial: Using Expressions in Labels

This tutorial demonstrates how to use expressions, which are mathematical formulas that modify a property within a label style.

You use text, lines, and block data components to present static data in a label style. Expressions modify the data in the standard label style components. For example, in the Layout tab of the Label Style Composer dialog box, you can insert an expression in place of a static value when determining the text height of a label. This expression could increase the text height of a spot elevation label to coincide with the elevation height.

In this tutorial, you will update an existing label style to add an expression that displays magnetic compass directions of the alignment at each geometry point.

For more information, see the AutoCAD Civil 3D Help topic *Expressions*.

Exercise 1: Creating an Expression

In this exercise, you will create an expression that calculates the magnetic compass direction of an alignment at each geometry point.

Expressions make use of the same properties that you can add to label styles, such as Point Elevation, Northing, and Easting. By using expressions, you can set up separate mathematical formulas, using the existing properties. For example, you could subtract a value from a point elevation, and display that number along side the actual elevation in a point label.

For more information, see the AutoCAD Civil 3D Help topic *Setting Up Expressions*.

Create an expression

NOTE This exercise uses *Labels-5c.dwg* with the modifications you made in the previous exercise, or you can open *Labels-6a.dwg* from the [tutorial drawings folder](#) (page 819).

- 1 Zoom and pan to the area between stations 0+000 and 0+100 of the Main Street alignment.
- 2 Click the PC: 0+035.99 label to select all geometry point labels. Right-click. Click Properties.
- 3 On the Properties palette, in the Geometry Point Label Style list, select Additional Details.
This label style displays geometry points, design speed, and true compass direction at the geometry point. In the next few steps, you will create an expression to calculate the magnetic direction. You will add this expression to the geometry point label in [Exercise 2: Inserting an Expression Into a Label Style](#) (page 803).
- 4 In Toolspace, on the Settings tab, expand Alignment ► Label Styles ► Station ► Geometry Point. Right-click the Expressions node. Click New.
- 5 In the New Expression dialog box, specify the following parameters:
 - Name: Magnetic Direction
 - Description: Converts true to magnetic for declination -15.5 degrees.
- 6 Click  Insert Property. Click Instantaneous Direction.
This property will be used as the basis for computing the magnetic direction.

- 7 In the New Expression dialog box, in the Expression field, use the keypad to enter $-(15.5*(2*\pi/360))$.

NOTE Use the  button to enter pi.

The completed equation looks like this:

{Instantaneous Direction} $-(15.5*(2*\pi/360))$

The expression includes a conversion from degrees to radians because AutoCAD Civil 3D uses radians for all internal angle calculations. The value used for declination of magnetic North (-15.5 degrees) is just an example. To be accurate, this must match the current value, subject to geographical location and gradual changes over time.

- 8 In the Format Result As list, select Direction.
- 9 Click OK.

In Toolspace, on the Settings tab,  appears next to the Expressions node, and the new expression appears in the list view.

To continue this tutorial, go to [Exercise 2: Inserting an Expression Into a Label Style](#) (page 803).

Exercise 2: Inserting an Expression Into a Label Style

In this exercise, you will insert an expression into an existing label style.

After you set up expressions, they are available in the Properties list in the Text Component Editor so that you can add them to label styles. In effect, expressions become new properties that you can use to compose a label style.



Expressions are unique to a particular label style type. Only those properties that are relevant to the label style type are available in the Expressions dialog box.

For more information, see the AutoCAD Civil 3D Help topic *Inserting Expressions into Label Styles as Properties*.

This exercise continues from [Exercise 1: Creating an Expression](#) (page 802).

Insert an expression into a label style

NOTE This exercise uses *Labels-6a.dwg* with the modifications you made in the previous exercise.

- 1 In Toolspace, on the Settings tab, expand Alignment ► Label Styles ► Station ► Geometry Point. Right-click Additional Details. Click Edit.
- 2 In the Label Style Composer dialog box, on the Layout tab, under Text, in the Contents row, click the Value column. Click .
- 3 In the Text Component Editor, in the Preview pane, place the cursor on a new line below the last property (True Instantaneous Direction).
- 4 Enter the following text, including the space after the colon: MAG: .
- 5 On the Properties tab, in the Properties list, select Magnetic Direction, which is the expression you created in [Exercise 1: Creating an Expression](#) (page 802), at the top of the list.
- 6 In the table, ensure that the value for Unit is Degree, and the Format is DD°MM'SS.SS" (unspaced).
- 7 Ensure that the cursor in the right window is located just after the Mag: label text. Click  to add the magnetic compass direction to the label formula.
- 8 Click OK.
The modified labels appear in the Preview pane of the Label Style Composer dialog box.
- 9 In the Label Style Composer dialog box, click OK.
- 10 Press Esc to deselect the labels.
Examine the geometry point labels to see the effect of the expression you added.

Plan Production Tutorials

20

These tutorials will get you started working with the plan production tools, which automate the process of creating construction documents from your designs.

The plan production tools simplify the process for preparing sheets from your design drawings. However, these tutorial exercises do not go into detail about the Sheet Set Manager or plotting or publishing processes. For information about these features, see the AutoCAD Help.

You can use the plan production tools with or without using project management (Autodesk Vault). If you choose to manage your plan production files (sheet set files, sheet files, templates) with Autodesk Vault, you must log in to the appropriate project and have the necessary files checked out for editing. For more information, see the AutoCAD Civil 3D Help topic *Using Vault with Plan Production Tools*.

The following tutorial exercises do not use the Autodesk Vault (project management) features.

NOTE All drawings used in these tutorials are available in the [tutorial drawings folder](#) (page 819). If you want to save your work from these tutorials, save the drawings to the [My Civil Tutorial Data folder](#) (page 819) so that you do not overwrite the original drawings.

For more information, see the AutoCAD Civil 3D Help topic *Plan Production Tools*.

Tutorial: Preparing a Drawing for Plan and Profile Sheet Layout

This tutorial demonstrates how to set up a drawing before you publish plan and profile sheets.

Instead of having to manually create many viewports on layouts to show segments of alignments, you can create view frames that automatically capture predefined areas along an alignment. This automation saves you from making manual changes when your design data changes. After you select an alignment

in your drawing, in just a few seconds you can create sheets that automatically display the desired data.

NOTE To set up a drawing for creating cross section sheets, see the [Creating Section Views tutorial](#) (page 569).

For more information, see the AutoCAD Civil 3D Help topic *Preparing for Plan Production*.

Exercise 1: Configuring Viewports

In this exercise, you will learn how to prepare an existing drawing template for use with the plan production tools.

Before using your own custom templates for plan production, you must set the layout viewport type to either *Plan* or *Profile*.

By default, most of the templates provided with AutoCAD Civil 3D have the Viewport Type property set to Undefined. However, the plan production templates that are included have viewports that are already configured to the appropriate viewport type: plan or profile.

For more information, see the AutoCAD Civil 3D Help topic *Setting Up Drawing Templates for Plan Production*.

Examine viewport properties in an existing template

- 1 Click Quick Access toolbar ►  Open. Navigate to the [local Template\Plan Production folder](#) (page 819). Open *Civil 3D (Imperial) Plan and Profile.dwt*.

NOTE In the Select File dialog box, ensure that Files of Type is set to *Drawing Template (*.dwt)*.

The template contains two viewports.

- 2 Select the top viewport. Right-click. Click Properties.
Examine the settings of the viewport, including the size and position contained in the Geometry category.
- 3 On the Properties palette, scroll down to the Viewport category.
- 4 Double-click the cell next to Viewport Type.
The drop-down list displays the configuration options for the viewport. The current (top) viewport is set to Plan, while the bottom viewport is

set to Profile. These settings specify that when you use this template in the plan production process, the plan view of the alignment will appear in the top viewport, and the corresponding profile will appear in the bottom viewport.

By default, all templates that are not contained in the [local Template\Plan Production folder](#) (page 819) have their Viewport Type set to Undefined. To configure your custom templates for use with the plan production process, you must change the viewport setting as appropriate.

- 5 Close *Civil 3D (Imperial) Plan and Profile.dwt*, but do not save it.

To continue this tutorial, go to [Exercise 2: Creating View Frames](#) (page 807).

Exercise 2: Creating View Frames

In this exercise, you will use the Create View Frames wizard to quickly create view frames along an alignment.

View frames are rectangular areas along an alignment that represent what is displayed in the associated viewports on the layouts (sheets) to be created.

Before you create view frames, you must have the desired alignment already in your drawing. Depending on the type of sheets you want to produce (plan only, profile only, or plan and profile), you may also need to have a profile already created. If you are creating plan only sheets, then you do not need to have a profile in the drawing.

For more information, see the AutoCAD Civil 3D Help topic *Creating View Frames*.



This exercise continues from [Exercise 1: Configuring Viewports](#) (page 806).

Create view frames

- 1 Open *Plan Production-View Frames-Create.dwg*, which is located in the [tutorial drawings folder](#) (page 819).

NOTE In the Select File dialog box, ensure that Files of Type is set to *Drawing (*.dwg)*.

- 2 Click Output tab ► Plan Production panel ► Create View Frames  .

- 3 In the Create View Frames wizard, on the Alignment page, specify the following parameters:
 - Alignment: Maple Road
 - Station Range: Automatic
This setting selects the entire Maple Road alignment.
- 4 Click Next.
- 5 On the Sheets page, under Sheet Settings, select Plan And Profile.
This setting creates sheets that display both plan and profile views for each view frame.
- 6 Under Template For Plan And Profile Sheet, click .
- 7 In the Select Layout As Sheet Template dialog box, click .
- 8 In the Select Layout As Sheet Template dialog box, browse to the [local Template\Plan Production folder](#) (page 819). Select *Civil 3D (Imperial) Plan and Profile.dwt*. Click Open.
- 9 In the Select Layout As Sheet Template dialog box, under Select A Layout To Create New Sheets, select ANSI D Plan And Profile 40 Scale.
- 10 Click OK.
- 11 In the View Frame Placement section, select Along Alignment.
This setting aligns the view frames along the alignment, as shown in the graphic in the wizard.
- 12 Select the Set The First View Frame Before The Start Of The Alignment By option, and enter 50.000' in the value field.
This option sets the distance that the first view frame is placed before the start of the alignment. Entering a distance here provides the specified amount of space before the alignment starting station. This distance ensures that the alignment start location does not coincide with the start of the view frame. If this check box is not selected, then the first view frame is placed at the start of the alignment.
- 13 Click Next to open the View Frame Group page.
View frame groups are created automatically. This page lets you specify the object creation criteria for the view frame group object. Examine the settings that are available, but accept the default settings for this exercise.
- 14 Click Next to open the Match Lines page.

Match lines are straight lines that are drawn across an alignment in plan view to indicate where the corresponding sheet for that alignment begins and ends. Match lines typically include labels that can identify the previous and next sheet (view frame) along the alignment. Examine the settings that are available, but accept the default settings for this exercise.

15 Click Next.

16 On the Profile Views page, specify the following parameters:

- Profile View Style: Major Grids
- Band Set: Stations Only

17 Click Create View Frames.

The view frames are displayed along the alignment in the drawing window. The match lines are displayed as annotated lines between the view frames.

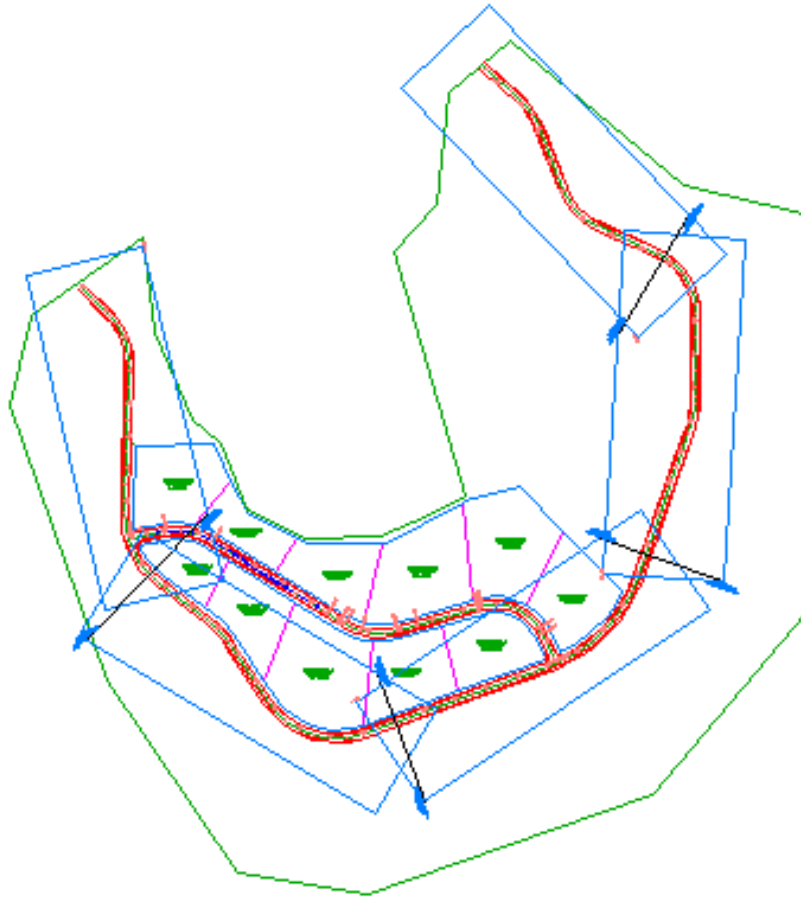

- 18** In Toolspace, on the Prospector tab, expand View Frame Groups, then expand the VFG - Maple Road collection.
Expand the View Frames and Match Lines collections. Notice that they contain the same components you created during the view frame group creation process.
- 19** In Toolspace, on the Prospector tab, right-click one of the view frames. Notice that you may zoom or pan to the view frame in the drawing. Notice that you may also create a sheet for the individual view frame. In the [Creating Plan and Profile Sheets](#) (page 811), you will create sheets for all the view frames.

To continue to the next tutorial, go to [Generating Sheets for Plotting](#) (page 811).

Tutorial: Generating Sheets for Plotting

This tutorial demonstrates how to generate plot-ready sheets that display either plan and profile or cross sections.

For more information, see the AutoCAD Civil 3D Help topics *Plan/Profile Sheet Production* and *Section Sheet Production*.

Exercise 1: Creating Plan and Profile Sheets

In this exercise, you will create plan and profile sheets from the view frames you created in an earlier exercise.

After you have used the Create View Frames wizard to create view frames, then you can create sheets using the Create Sheets wizard.

The sheets that are created represent the layouts (*sheets*) that are used for construction documents (*plans*).



For more information, see the AutoCAD Civil 3D Help topic *Creating Plan/Profile Sheets*.

Specify the sheet creation settings



- 1 Open *Plan Production-Plan Profile Sheets-Create.dwg*, which is located in the [tutorial drawings folder](#) (page 819).

The current drawing must be saved before you create section sheets. To prevent the tutorial drawing from being overwritten, save it to an alternate location.



- 2 Click  ► Save As.
- 3 In the Save Drawing As dialog box, navigate to the [My Civil Tutorial Data folder](#) (page 819). Click Save.
- 4 Click Output tab ► Plan Production panel ► Create Sheets .

NOTE On any page of this wizard, you may click Create Sheets to create the sheets using the default choices on the wizard pages. If there are criteria that have not been supplied, then the Create Sheets button is not available.

- 5 In the Create Sheets wizard, on the View Frame Group And Layouts page, specify the following parameters:
 - View Frame Group: VFG - Maple Road.
Notice that you may select all view frames in the group or a selection of view frames within the currently selected view frame group.
 - Layout Creation: Number Of Layouts Per New Drawing. Accept the default value of 1.
This option creates a drawing for each layout (sheet). If you enter a value greater than one, three for example, three layouts are created in each new drawing. The total number of sheets and drawings would depend on the length of the alignment selected and other criteria, such as the size and scale of the viewports in the referenced template. You can only enter an integer that is between zero and 256.
 - Choose The North Arrow Block To Align In Layouts: North.
This option orients a North arrow block that is defined in the template. This list is populated with all blocks that are present in the current drawing. Notice that there is a (none) selection available, if you do not wish to include a North arrow block.
- 6 Click Next.
- 7 On the Sheet Set page, under Sheet Set, select New Sheet Set.
This option specifies that a new sheet set be created to organize the new sheets. A sheet set allows you to manage and publish a series of sheets as a unit. In the following steps, you will specify a location for the individual sheets and the sheet set data (*DST*) file. For best results, store the sheet set data file and its associated sheet files in the same location. For more information about working with sheets and sheet sets, see the AutoCAD Help.
- 8 Click  next to Sheet Set File (.DST) Storage Location.
- 9 In the Browse For Sheet Set Folder dialog box, navigate to the [My Civil Tutorial Data folder](#) (page 819). Click Open.
- 10 Click  next to Sheet Files Storage Location.

11 In the Browse For Folder dialog box, navigate to the [My Civil Tutorial Data folder](#) (page 819). Click Open.

12 Click Next.

NOTE If the view frames do not include any profile views, then the Profile Views page in the Create Sheets wizard is skipped. The Data References page is displayed next.

13 On the Profile Views page, under Other Profile View Options, select Choose Settings.

NOTE You specified the Profile View Settings during [Exercise 2: Creating View Frames](#) (page 807).

14 Click Profile View Wizard.

15 In the Create Multiple Profile Views wizard, use the links along the left side or the Back and Next buttons to examine the available settings. Many of the settings are not available because they are already defined by the currently selected view frame group.

For more information, see the [Creating Multiple Profile Views](#) (page 324) tutorial exercise.

16 Click Finish.

17 In the Create Sheets wizard, under Align Views, select Align Profile And Plan View At Start.

This option aligns the alignment starting station in plan view with the profile starting station in profile view. The profile view shifts to the right to accommodate the exact alignment starting station.

18 Click Next.

19 On the Data References page, you can select or omit the objects for which you want references included in your sheets. Notice that the Maple Road alignment and profile are selected by default.

20 Select the check box next to Pipe Networks.

Create sheets

1 Click Create Sheets to close the wizard and create the sheets. When you are prompted to save the current drawing, click OK.

- 2 When prompted, pan to a clear area in the drawing, then click a location for the profile view origin.
After your sheets are created, the Sheet Set Manager is displayed, showing the newly created sheets. For more information on the Sheet Set Manager, see the Sheet Set Manager Help topics in the AutoCAD Help.
- 3 If the Sheet Set Manager does not open, enter SHEETSET on the command line.
- 4 On the Sheet Set Manager, select Open from the drop-down list.
- 5 On the Open Sheet Set dialog box, navigate to the [My Civil Tutorial Data folder](#) (page 819) and select *VFG - Maple Road.dst*. Click Open.
On the Sheet Set Manager, notice that the *VFG - Maple Road - (1).dst* is open, displaying the five sheets that were created.
- 6 Select one of the sheets in the list. Right-click and select Open.
The sheet opens as a new drawing.

NOTE You can publish your sheet(s) directly from the Sheet Set Manager or share them by using the eTransmit feature.

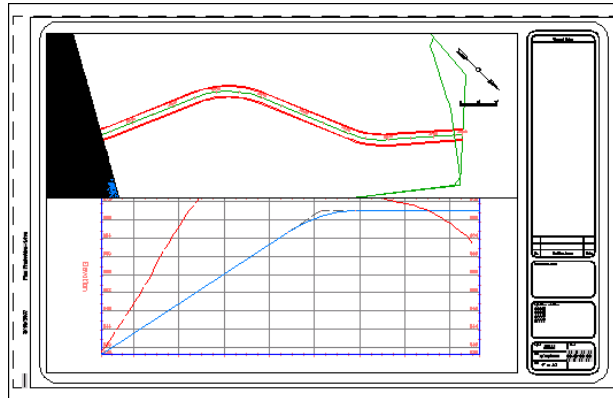

To continue this tutorial, go to [Exercise 2: Creating Section Sheets](#) (page 814).

Exercise 2: Creating Section Sheets

In this exercise, you will create sheets from section views.

NOTE To create section views, see the [Creating Section Views tutorial](#) (page 569).

For more information, see the AutoCAD Civil 3D Help topic *Section Sheet Production*.

This exercise continues from [Exercise 1: Creating Plan and Profile Sheets](#) (page 811).

Open and save the drawing

- 1 Open *Plan Production-Section Sheets-Create.dwg*, which is located in the [tutorial drawings folder](#) (page 819).

The current drawing must be saved before you create section sheets. To prevent the tutorial drawing from being overwritten, save it to an alternate location.



- 2 Click  ► Save As.

- 3 In the Save Drawing As dialog box, navigate to the [My Civil Tutorial Data folder](#) (page 819). Click Save.

Create section sheets

- 1 Click Output tab ► Plan Production panel ► Create Section Sheets .

- 2 In the Create Section Sheets dialog box, specify the following basic parameters:

- Select Alignment: Centerline (1)
- Sample Line Group Name: SLG-1
- Select Section View Group: Section View Group - 1

- 3 Under Layout Settings, click .

You can use the Name Template dialog box to specify a default name for each of the layouts. In this exercise, you will accept the default layout name template.

- 4 Click Cancel.
- 5 In the Create Section Sheets dialog box, under Sheet Set, make sure that New Sheet Set is selected.

- 6 Under Sheet Set File (.DST) Storage Location, click .

- 7 In the Browse for Sheet Set Folder dialog box, navigate to the [My Civil Tutorial Data folder](#) (page 819). Click Open.
- 8 Click Create Sheets.
- 9 When you are notified that the drawing will be saved, click OK.
When the drawing is saved, the following tasks are completed:
 - Layouts are created.
 - A sheet set database is created.
 - The Sheet Set Manager window opens.

Examine the section sheets

When the sheets are generated, they are displayed in the Sheet Set Manager window.

- 1 In the Sheet Set Manager window, under Section View Group - 1, double-click the first entry.
- 2 Select the rectangular section view border. Right-click. Click Properties.

NOTE In the following image, the section view border is red.

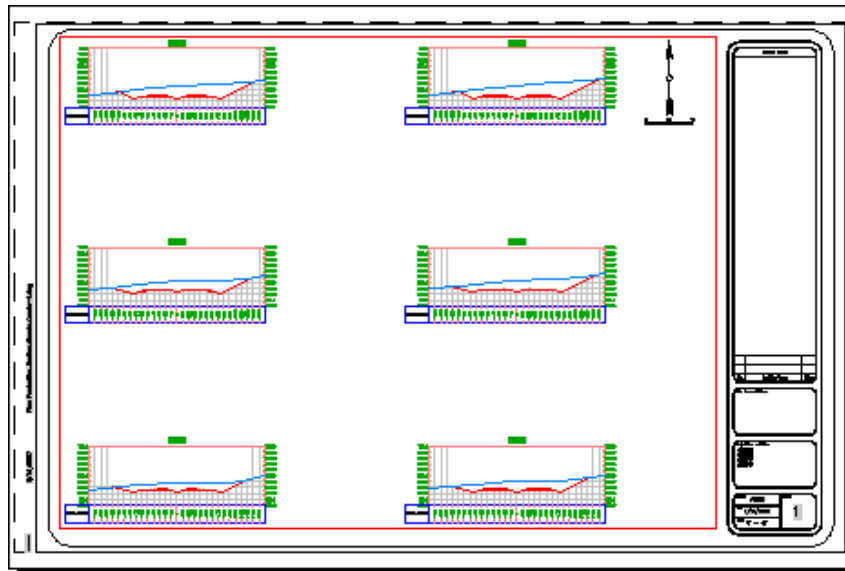

In the Properties window, under Misc, notice the Standard Scale property. This value should match the drawing scale of the source drawing.

- 3 Close the Properties window.
- 4 On the AutoCAD status bar, right-click  Click Display Layout and Model Tabs.
At the bottom of the drawing, Model, Layout, and Sheet tabs are displayed.
- 5 Click the Model tab.

Modify a section view

- 1 Zoom in to the first section view, which is in the lower left-hand corner of the leftmost section sheet.
- 2 On the left-hand side of the section view, select the offset and elevation label.
- 3 Click the  grip. Drag the grip up and to the right. Click the place the label.
- 4 Repeat Steps 2 and 3 to move the offset and elevation label on the right-hand side of the section view.
- 5 At the bottom of the drawing, click the Section Sheet - (1) tab.
- 6 Zoom in to the first section view, which is in the lower left-hand corner of the layout.
The label changes have been applied to the section view. The model is dynamically linked to the section view sheets.

Tutorial Folder Locations

Assemblies folder Windows XP: *C:\Documents and Settings\All Users\Application Data\Autodesk\C3D 2011\enu\Assemblies*

Windows Vista: *C:\ProgramData\Autodesk\C3D 2011\enu\Assemblies*

Windows 7: *C:\ProgramData\Autodesk\C3D 2011\enu\Assemblies*

Autodesk Documents folder Windows XP: *C:\Documents and Settings\[user name]\My Documents\Autodesk*

Windows Vista: *C:\Users\[user name]\Documents\Autodesk*

Windows 7: *C:\Users\[user name]\Documents\Autodesk*

Civil 3D Project Templates folder *C:\Civil 3D Project Templates*

Civil 3D Projects folder *C:\Civil 3D Projects*

Data folder Windows XP: *C:\Documents and Settings\All Users\Application Data\Autodesk\C3D 2011\enu\Data*

Windows Vista: *C:\ProgramData\Autodesk\C3D 2011\enu\Data*

Windows 7: *C:\ProgramData\Autodesk\C3D2011\enu\Data*

Local Template folder Windows XP: *C:\Documents and Settings\[user name]\Local Settings\Application Data\Autodesk\C3D 2011\enu\Template*

Windows Vista: *C:\Users\[user name]\AppData\Local\Autodesk\C3D 2011\enu\Template*

Windows 7: *C:\Users\[user name]\AppData\Local\Autodesk\C3D 2011\enu\Template*

My Civil Tutorial Data folder If this folder does not already exist, create it at the following location to save the tutorial drawings as you work on them:

Windows XP: *C:\Documents and Settings\[user name]\My Documents\Autodesk*

Windows Vista: *C:\Users\[user name]\Documents\Autodesk*

Windows 7: *C:\Users\[user name]\My Documents\Autodesk*

tutorial drawings folder *<AutoCAD Civil 3D installation location>\Help\Civil Tutorials\Drawings*

tutorial folder *<AutoCAD Civil 3D installation location>\Help\Civil Tutorials*

Index

A

- alignments
 - creating 213
 - creating with layout tools 214
 - criteria-based design, correcting violations 253
 - criteria-based design, creating with 248
 - curves and spirals, adding 217
 - design checks, working with 256
 - design criteria file, working with 259
 - editing 223, 225
 - floating curves, adding 219
 - grip editing 225
 - mask, applying to an alignment region 227
 - offset alignments
 - editing 236
 - working with 232
 - offset alignments, creating 233
 - parameters, editing 223
 - parcels, working with 359
 - selecting subentities 223
 - site interaction 359
 - tutorials 213
 - widenings
 - adding 239, 243
- assemblies
 - copying to a tool catalog 451
 - divided highway, creating 472
 - managing 430
 - name template, modifying 427
 - saving and sharing 448
 - saving to a tool palette 449
 - simple, creating 422
 - tutorials 421
 - with conditional subassemblies 433
- assembly
 - with transition lane, creating 464

- astronomic direction calculator, using for azimuth calculations 167
- AutoCAD Civil 3D, overview 5
- Autodesk Vault. *See* Vault

B

- blocks
 - multi-view, moving to surface 111
- borrow pits, adding 598
 - See also* dump sites
- boundaries
 - adding to surface 93
 - corridor, creating 486
 - data clip 74
 - outer, adding to a surface 71
- breaklines
 - adding 65

C

- catchment areas, calculating 101
- catchment regions
 - creating 101
- commands
 - finding 6
- comparison surfaces, creating 106
- corridor
 - basic, creating 460
 - divided highway, creating 476
 - with transition lane, creating 467
- corridor section viewer
 - using 477
- corridor surface
 - boundaries, creating 486
 - creating 483
 - rendering 490
- corridors
 - boundaries, creating 486
 - earthwork volumes, calculating 589
 - tutorials 459

- viewing and rendering 483
- viewing sections 477
- with a transition lane, creating 463
- criteria-based design
 - correcting violations 253
 - criteria violations, correcting 301
 - design checks, working with 256
 - design criteria file, modifying 259
 - designing an alignment using 248
 - designing profiles using 297
 - drawing profiles using 299
- cross sections
 - displaying on alignments 569
- curves
 - adding floating curves 219
 - adding free curves 217
- cut and fill volumes, adjusting 402

D

- data bands
 - adding to profile view 331
 - adding to section views 587
 - displaying and managing 330
 - editing in profile view 331
 - labels, moving 336
 - styles, editing 339
- data shortcut projects, importing into
 - Vault 212
- data shortcuts
 - creating 187
 - project folder, setting up 184
 - referencing 189
 - using 183
- description keys
 - creating 25–26
- design checks
 - working with 256
- design criteria file
 - modifying 259
- display order, parcels 382
- drawings
 - externally referenced, displaying 31
 - externally referenced, removing 35
- dump sites, adding 598
 - See also* borrow pits

- DYN. *See* dynamic input
- dynamic input 17

E

- elevation
 - editing in a grading 400
- exporting
 - parcel data 385
 - Vault projects 211
- expressions
 - as label style components 803
 - creating 802
 - inserting in a label 803
 - labels, using in 801
- external references
 - to drawings 31

F

- feature lines
 - creating 392
 - crossing, working with 415
 - elevations, assigning 395
 - elevations, editing 415
 - offsetting, in grading 405
 - rounding corners in 405
 - smoothing 412
 - using as breaklines, in grading 414
- figures
 - editing 146
- floating curves
 - adding to alignments 219
- free curves, adding to alignments 217

G

- Google Earth
 - image, importing 121
 - publishing design data to 117
- grading
 - building footprints, simplifying 405
 - complex footprints, working
 - with 404
 - corners, inside 412

- creating 392, 397, 408
- criteria, creating 388
- criteria, editing 403
- editing 400, 412
- elevation, editing 400
- filling a void area 410
- point of vertical intersection (PVI) 395, 415
- settings, reviewing 388
- standards, setting up 387
- styles, creating 391
- surfaces 414
- tutorials 387
- volume balancing 402

H

- hatching
 - corridors 490
- horizontal alignments, tutorials 213

I

- intersection
 - all crowns maintained, creating 497
 - three-way, creating 497
- intersections
 - corridor, creating in 533
 - creating 496
 - editing 516
 - horizontal geometry, editing 516
 - offset alignments and profiles, creating from existing 508
 - primary road crown maintained, creating 503
 - recreating corridors 533
 - tutorials 495
 - vertical geometry, editing 525
 - with turn lanes, creating 503

L

- labels
 - adding and editing 744
 - adding to drawings 752

- appearance, controlling using layers 783
- changing appearance 776
- content, changing 763
- creating child styles 780
- data band, staggering in 336
- dragged state, managing 789
- expressions 801
- externally referenced drawings and 740
- label text, overriding 764
- layers 783
- levels of settings, defining 765
- moving in drawings 755
- pipe networks 646
- preparation 740
- properties 761
- referencing other objects 797
- section view 586
- selecting 755
- sets, using 745
- styles 776, 793
- styles, creating 776
- tags 770
- tags, numbering 774
- tutorials 739
- xref 740
- xref drawing, creating in 745

- layers
 - label objects 783
- layout profiles
 - creating 288
 - editing 292
- least squares analysis
 - reducing survey information with 152
- linework code sets
 - creating 135

M

- mapcheck analysis. *See* mapcheck reports
- mapcheck reports
 - data, working with 179
 - entering data manually 176
 - parcel 173

- mapcheck reports, used in parcel
 - export 385
- mass haul diagrams
 - balancing volumes in 598
 - creating 596
 - creating and editing 594
- mass haul lines
 - styles 601
- match lines
 - creating with view frames 807
- material calculation
 - tutorials 589
- model views, viewing civil objects in 21
- multi-view blocks
 - moving to surface 111
- multiple profile views
 - creating 324
 - in plan production 324

N

- named views, using 17

O

- object snap, using 16
- objects
 - deselecting 16
 - extracting from surface 100
 - selecting 16
 - viewing 17
- offset profiles, designing 294
- OSNAP. *See* object snap
- outer boundaries, adding 71

P

- pan and zoom controls 15
- Panorama window
 - using 12
- parcels
 - alignments, and 359
 - area table, creating 768
 - AutoCAD objects, creating parcels from 341

- creating 341
 - from AutoCAD objects 342
- data, exporting 385
- display order 382
- displaying and analyzing 381
- editing 361
- free-form segment, subdividing a
 - parcel with 345
- geometry, editing 375
- size, editing 362, 368
- slide line, subdividing a parcel
 - with 348, 362
- swing line, subdividing a parcel
 - with 355, 368
- tutorials 341

Part Builder

- creating cylindrical manhole structure
 - in 657
- creating drop inlet manhole structure
 - in 676
- creating vault structure in 705
- tutorial 657
- verifying new part 673

parts list

- adding parts to 639

pay item quantities

- AutoCAD objects, assigning pay item
 - codes to 606
- calculating and reporting 603
- corridors, assigning pay item codes
 - to 616
- formulas, creating for pay items 622
- pay item categorization file,
 - loading 604
- pay item list, creating 625
- pay item list, loading and
 - navigating 604
- pipe network parts, assigning pay item
 - codes to 612
- reports, generating 619

pipe networks

- branch, adding 642
- creating 629–630
- cylindrical manhole structure,
 - creating 657

- drop inlet manhole structure,
 - creating 676
 - labels, adding to pipe network
 - parts 646
 - layout, creating by 635
 - parts list, adding parts to 639
 - parts, adding to a pipe network 637
 - parts, viewing in section view 652
 - pipe and structure tables,
 - creating 653
 - profile view, editing in 649
 - profile view, viewing in 645
 - properties 639
 - surface, alignment, and rules,
 - changing 640
 - tutorials 629
 - vault structure, creating 705
 - viewing and editing 645
- pipe tables 653
- plan production
 - sheets, creating 811
 - tools, using 805
 - tutorials 805
 - view frames, creating 807
 - viewports, configuring 806
- point data
 - adding to surfaces 64
 - creating 25
- point groups
 - creating 27
 - display order, changing 33
 - displaying 30
 - editing 30
 - style, changing 32
 - user-defined properties, assigning
 - to 41
- points
 - description keys and point
 - groups 25
 - description keys, creating 26
 - editing 35
 - importing 29
 - tutorials 25
 - user-defined properties 37
- profile views
 - creating and displaying 280
- data bands 331
- displaying 280
- displaying and managing 304
- hatch patterns between profiles,
 - adding 310
- managing 304
- multiple line 326
- multiple, creating 324
- pipe network, drawing 645
- pipe network, editing 649
- projected objects, adding 314
- splitting 321
- stacked, creating 326
- styles, editing 305
- profiles
 - characteristics, reviewing 285
 - copying 294
 - creating 275
 - criteria-based design 299
 - criteria-based design in 297, 301
 - criteria, specifying 298
 - design 287
 - finished grade 287
 - hatch patterns between, adding 310
 - layout 287–288, 292
 - locked PVIs, editing 525
 - multiple line 326
 - offsetting vertically 294
 - stacked 326
 - style, changing 282
 - surface 279–280
 - tutorials 275
- project management
 - data shortcuts, using 183
 - tutorials 183
- project objects
 - checking in 205
 - checking out 204
 - modifying 204
 - reference to, creating 202
 - tutorials 200
 - updating 206
- project point data 207
- project points
 - checking in 210
 - checking out 209

- modifying 209
- projected objects
 - profile views, adding to 314
 - section views, adding to 577
- projects
 - adding drawings to 201
 - adding points to 207
 - creating 199
 - exporting 211
 - groups, creating 197
 - importing 212
 - logging in to 195
 - object data 200
 - setting up 195
 - specifying path 195
 - user accounts, creating 197

Q

- quantity takeoff
 - criteria settings, reviewing 590
 - volumes, calculating 593

R

- rendering
 - corridors 483
 - surfaces 114
- ribbon
 - finding Civil commands 6
- right-click menus. *See* shortcut menus
- roundabouts
 - tutorials 495
 - working with 538

S

- sample lines
 - creating 570
- sample tutorial drawings
 - saving 3
- section views
 - creating 572
 - data band, adding 587
 - data, adding 577

- grade labels, adding 586
- pipe network parts, viewing in 652
- projected objects, adding 577
- sections
 - corridor, editing 480
 - corridor, viewing 477
 - displaying on alignments 569
 - tutorials 569
- settings
 - survey 132
- Sheet Set Manager
 - plan production, using with 811
- sheets
 - plan production, creating for 811
- shortcut menus, using 15
- smoothing
 - surfaces 95
- split profiles 321
- structure tables 653
- styles
 - changing 19
 - grading, creating 391
 - labels 776
 - parts, overriding in pipe network 650
 - profile 282
 - watersheds 97
- surface profiles, creating and displaying 280
- surfaces
 - analyzing 96
 - comparison, creating 106
 - creating and adding data to 59
 - data, editing 86
 - data, publishing to Google Earth 117
 - draping images on 116, 124
 - imported data, limiting 74
 - labeling 84
 - large, working with 73
 - moving multi-view blocks to 111
 - objects, extracting from 100
 - outer boundaries, adding 71
 - point data, adding 64
 - profile 279
 - profile characteristics 285

- rendering 114
 - simplifying 79
 - smoothing 95
 - style and display, changing 81
 - styles, editing 82
 - styles, switching 83
 - TIN 63
 - tutorials 59
 - visualizing 111
 - volume information, generating 105
 - volume, calculating 110
 - survey
 - astronomic direction calculator 167
 - database, setting up 130
 - equipment database 130
 - figure prefix database 130
 - importing data 136
 - information, reducing using least squares analysis 152
 - output 171
 - reprocessing data 139
 - settings, adjusting 132
 - setup 129
 - styles 134
 - traverse analysis 150
 - tutorials 129
 - viewing data 144
 - survey command window
 - creating survey data with 164
 - survey data
 - adding manually 155
 - analyzing 147
 - creating 156, 160, 164
 - querying 148
 - viewing 144
 - survey databases
 - translating 154
 - survey figures
 - editing 146
- T**
- tables
 - creating 768
 - pipe and structure 653
 - tutorials 739
 - working with 767
 - tags
 - labels used as 770
 - renumbering 774
 - working with 767
 - TIN edges, swapping 88
 - TIN lines
 - deleting from surface 91
 - TIN surfaces
 - creating 63
 - volume, creating 109
 - tool catalogs
 - copying assemblies to 451
 - installing 454
 - publishing 453
 - tool palettes
 - adding assemblies to 449
 - Toolspace window
 - overview 10
 - traverse analysis
 - using to reduce survey data 150
 - traverse editor
 - creating survey data with 160
 - tutorials
 - alignments 213
 - assemblies 421
 - corridors 459
 - grading 387
 - intersections 495
 - labels and tables 739
 - material calculation 589
 - overview 1
 - parcels 341
 - Part Builder 657
 - pipe networks 629
 - plan production 805
 - points 25
 - profiles 275
 - project management 183
 - roundabouts 495
 - sample drawings 1
 - saving sample drawings 3
 - sections 569
 - surfaces 59
 - survey 129

U

- user interface
 - overview 5
- user-defined properties
 - adding to points 37
 - assigning to point groups 41
 - creating 37
 - importing points with 42
 - labels for 39
 - point file formats for 42
 - querying 44

V

- Vault
 - setting up 195
- Vault projects, exporting 211
- view frames
 - creating 807
- viewports
 - plan production, configuring for 806
 - setting up 17

- visual styles
 - applying 21
- visualization
 - corridors 483, 490
 - surface 111
- volume calculation, creating 110
- volumes
 - mass haul, balancing in 598

W

- water drop analysis
 - configuring 101
 - creating 96
- watersheds
 - analysis, creating 96
 - generating an analysis 98
 - legend, adding 99
 - style 97

X

- xrefs
 - labeling Civil drawings 740