

Serviços de Localização e Geoinformação

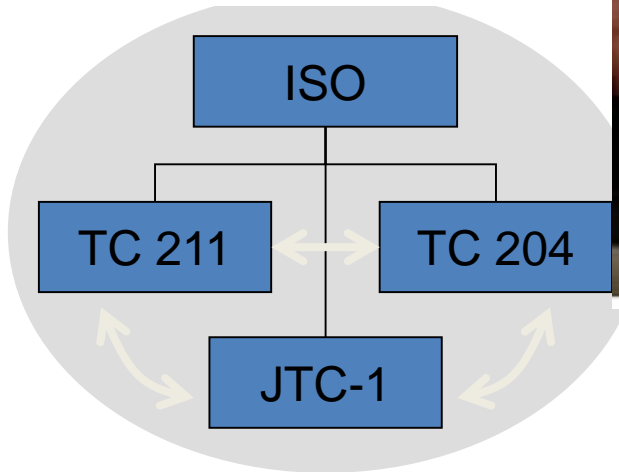
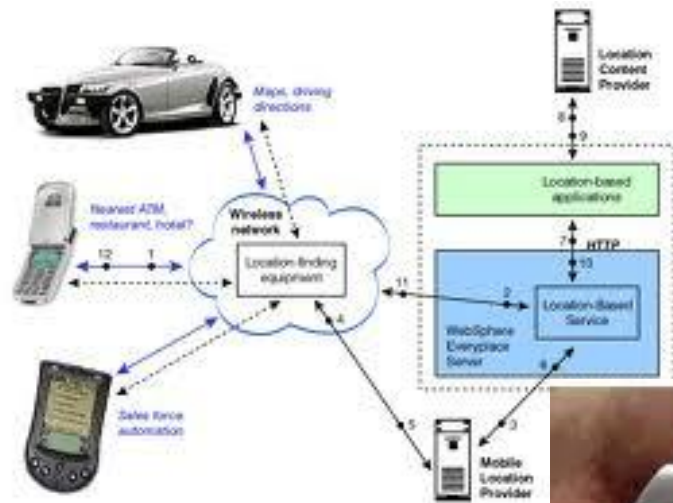

Modelação de Informação Geográfica

- ❑ Modelos de dados geográficos
- ❑ Níveis de abstracção de dados geográficos
- ❑ Modelo de dados OMT-G (UML)
 - Diagrama de classes
 - Diagrama de transformação
 - Diagrama de apresentação
- ❑ Restrições de integridade espaciais
- ❑ Mapeamento para esquemas de implementação

Reference: Borges_OMTG.pdf

Aspetos Normativos da Informação Geográfica

“Standards”

- Características das Normas
- A ISO
- ISO/TC211
- Modelo de Referencia
- Road-Map das ISO19100
- Elementos UML para IG
- Terminologia
- Serviços de Posicionamento
- A diretiva Inspire
- Definition of Annex Themes and Scope
- Coordinate Reference Systems (CRS)

ISO Standards for Geographic Information. Wolfgang Kresse and Kian Fadaie. Springer, 2004.

A Sociedade da Informação

- A Sociedade da Informação
- A Cidade Digital
- A Nova Mobilidade
- Convergência Tecnológica
- A Internet e a Web
- As novas tecnologias da Informação e comunicação
 - Redes wireless
- Web Semântica
- Novas Tecnologias Informação e Comunicação
- Telecomunicações Móveis sem fios
- Outras redes móveis sem fios (WLAN, Bluetooth)
- Internet GIS e Wireless GIS

Location-Based Services and Geo-Information Engineering. Allan Brimicombe and Chao Li. Wiley-Blackwell, 2009

Sistemas de Posicionamento

- Serviços Baseados na Localização
- Mandatos E911 e E112
- Arquitectura LBS
- Áreas de aplicação
- Tamanho e Granularidade
- Localização do Utilizador
- GNSS
- Indoor positioning
- Tecnologias de posicionamento baseadas em redes de telecomunicações
- Técnicas de posicionamento de reduzido alcance
- Sistemas Híbridos

O contexto nos SLG

- O Contexto nos LBS
- A Pesquisa Espacial
- Dados Geométricos
- Dados Topológicos
- Dados Atributos
- Temporalidade dos Dados
- Comunicação nos LBS
- Mapas nos LBS
- Aspectos Normativos
- Classificação funcional dos LBS
- O negócio dos LBS

Avaliação:

Exame Escrito	50 %
Apresentação e discussão do trabalho prático:	50%

Trabalho prático. O aluno deverá entregar o relatório com o trabalho prático em papel (1 exemplar) e os ficheiros com o trabalho realizado. A data limite para entrega do trabalho prático é dia 8 **dezembro de 2025**. A apresentação oral e discussão do trabalho prático será no dia 9 **de dezembro 2025 às 9 horas**.

Projecto 1. Navegação no campus da FCUL

Pretende-se disponibilizar a informação geográfica e alfanumérica do Campus da FCUL com informação relativa às suas infraestruturas e oferta pedagógica. O site deverá ser intuitivo e dirigido para os novos alunos da Universidade (nacionais ou Erasmus). Pretende-se que a informação relativa ao DEGGE seja exhaustiva (salas, docentes, laboratórios, ..)

Tarefas: Compilação de informação geográfica e alfanumérica do campus da Universidade de Lisboa. Estruturação da Informação – Catálogo de Entidades Geográficas (segundo ISO 19110) e diagrama de classes UML. Constituição de um sistema de informação geográfica do Campus da FCUL. Disponibilização da Informação Geográfica na Web. Configuração de dispositivos móveis para acesso à informação do campus.

Projecto 2. DashBoard ou StoryBoard

Criar um DashBoard ou StoryBoard do campus das FCUL

Calendarização das aulas Teóricas

(Class scheduling)

#	Conteúdo	Data
Aula 1	Modelação da base de dados (exercícios)	16 set.
Aula 2	Modelação da base de dados em OMTG	23 set.
Aula 3	Criação e preenchimento da base de dados em ArcGis	30 set.
Aula 4	Criação e preenchimento da base de dados em ArcGis	7 Out.
Aula 5	Criar relações entre entidades	14 Out.
Aula 6	Redes	21 Out.
Aula 7	Redes	28 Out.
Aula 8	Criar um WebSIG (WebApp)	4 Nov.
Aula 9	Criar um WebSIG (WebApp)	11 Nov.
Aula 10	Criar um WebSIG (WebApp)	18 Nov.
Aula 11	ArcGis Field Maps Verificação do funcionamento da aplicação	25 Nov.
Aula 12	DashBoard / StoryBoard	2 Dez.
Aula 13	DashBoard / StoryBoard	9 Dez.
Aula 14	Apresentação dos projectos DashBoard/Storyboard	16 Dez

Calendarização das aulas Práticas

(Class scheduling, practical)

#	Conteúdo	Data
Aula 1	Modelação da base de dados (exercícios)	16 set.
Aula 2	Modelação da base de dados em OMTG	23 set.
Aula 3	Criação e preenchimento da base de dados em ArcGis	30 set.
Aula 4	Criação e preenchimento da base de dados em ArcGis	7 Out.
Aula 5	Criar relações entre entidades	14 Out.
Aula 6	Redes	21 Out.
Aula 7	Redes	28 Out.
Aula 8	Criar um WebSIG (WebApp)	4 Nov.
Aula 9	Criar um WebSIG (WebApp)	11 Nov.
Aula 10	Criar um WebSIG (WebApp)	18 Nov.
Aula 11	ArcGis Field Maps Verificação do funcionamento da aplicação	25 Nov.
Aula 12	DashBoard / StoryBoard	2 Dez.
Aula 13	DashBoard / StoryBoard	9 Dez.
Aula 14	Apresentação do projecto	16 Dez

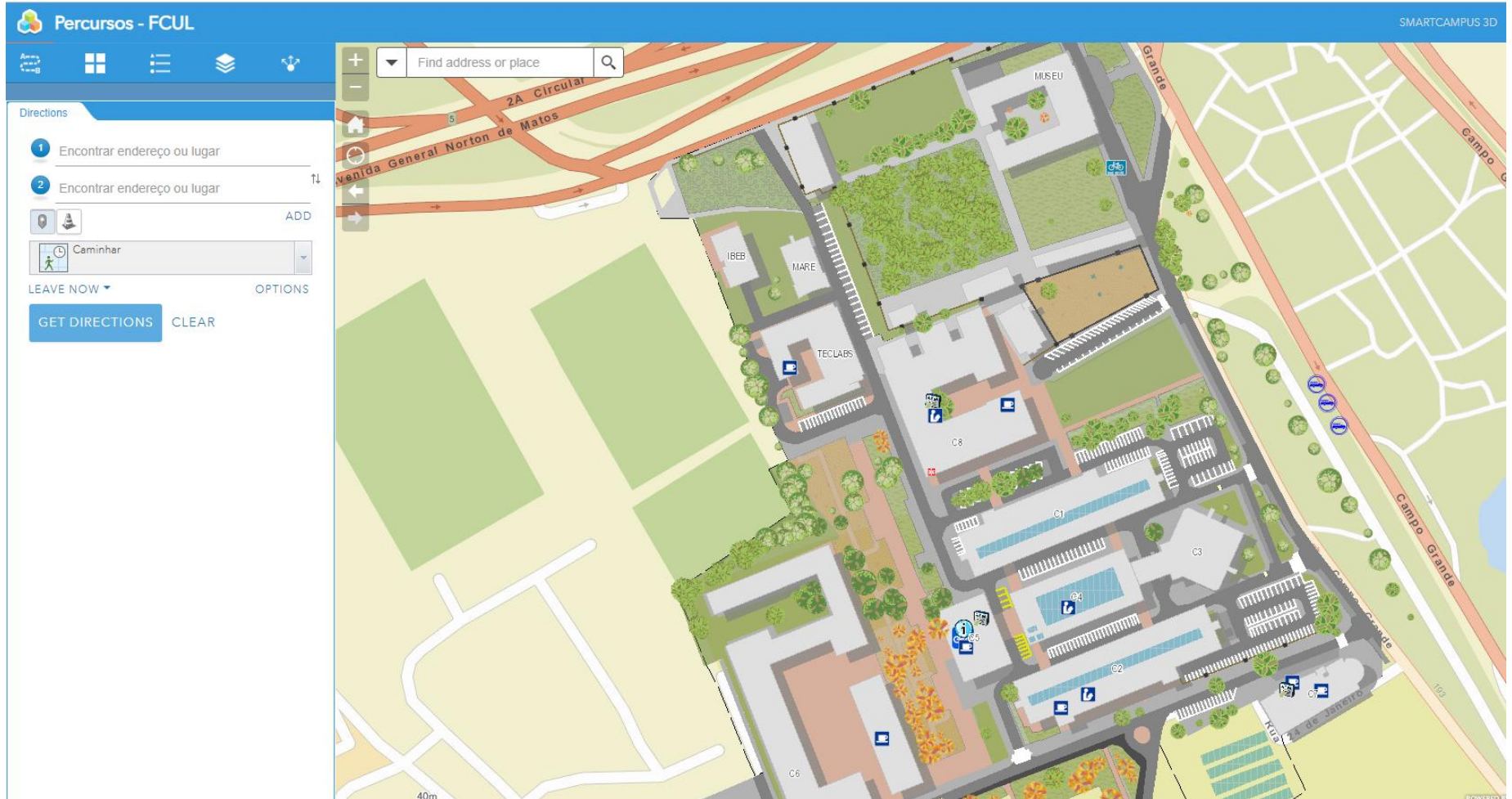



<http://www.arcgis.com/apps/webappviewer/index.html?id=11fd2c9f53a04a08bc95f2e823615036>

<http://fculdegge.maps.arcgis.com/apps/webappviewer/index.html?id=ddf6c56898cf48f4938117dc46edb8ba>

Rafael

<http://ulisboa.maps.arcgis.com/apps/webappviewer/index.html?id=0af9743c28004b76b0885d98d8e62ad2>

Tiago

<http://ulisboa.maps.arcgis.com/apps/webappviewer/index.html?id=3063c0af8a704c3989c915c900cf513f>

An Introduction to Story Maps

- 1 2 3 4 5 6 7 8 9 10 11 12 13 14 15 16 17 18 19 20 21 22 23 24 25 26

Stanford University Campus Tour

Explore Stanford University on a self-guided tour

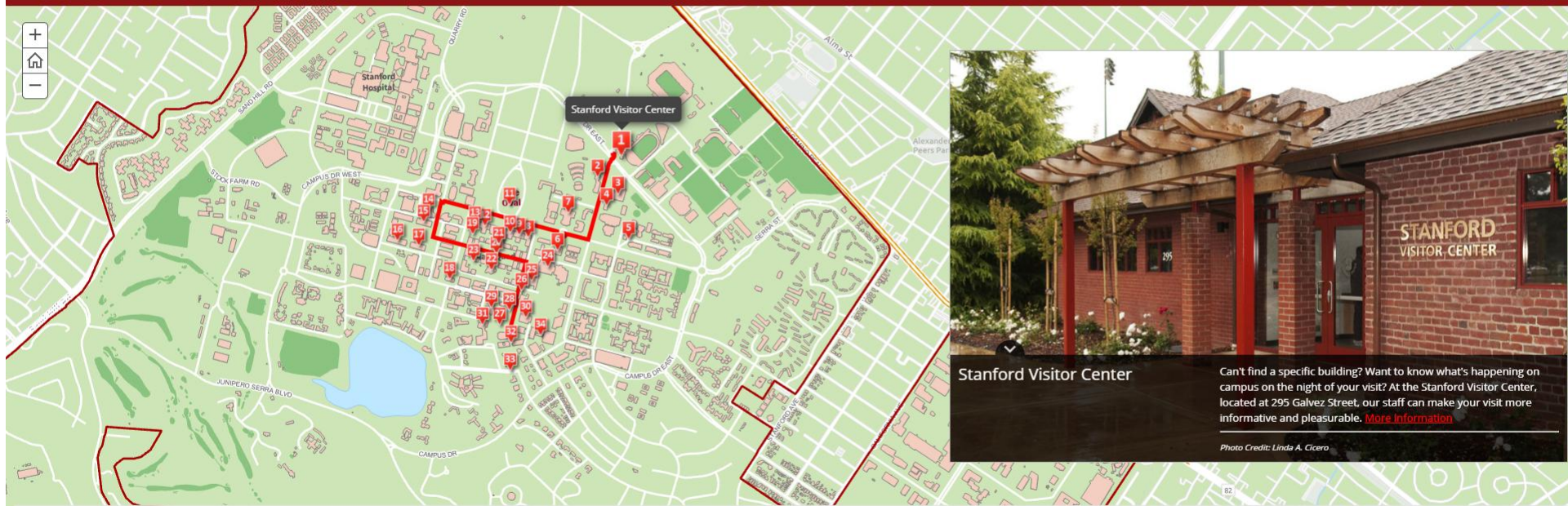

Stanford Visitor Center
Can't find a specific building? Want to know what's happening on campus on the night of your visit? At the Stanford Visitor Center, located at 295 Galvez Street, our staff can make your visit more informative and pleasurable. [More information](#)

Photo Credit: Linda A. Cicero

- 1 Stanford Visitor Center
- 2 Frances C. Arrillaga Alumni Center
- 3 Arrillaga Center for Sports & Recreation
- 4 Montagu Hall
- 5 Knight Management Center
- 6 Hoover Tower
- 7 Memorial Hall and Memorial Auditorium
- 8 Lane History Corner
- 9 Wallenberg Hall
- 10 McClatchy Hall
- 11 The Oval and Palm Drive
- 12 Jordan Hall

Indoor Positioning and navigation



Indoor Positioning and navigation

- Pessoas
- Máquinas
- Robots

ArcGIS Indoors allows you to create a 2D or 3D digital indoor map of your building, visualizing all rooms and amenities. The system gives all stakeholders of a company a common operating picture by providing enhanced insights into resource management and work processes.

Employees are empowered to interact with their workplace environment more actively and connect with each other face to face more easily. By increasing the transparency of workplace operations and encouraging engagement from all parties, workflow efficiencies and productivity can be increased.



Application domains of LBS

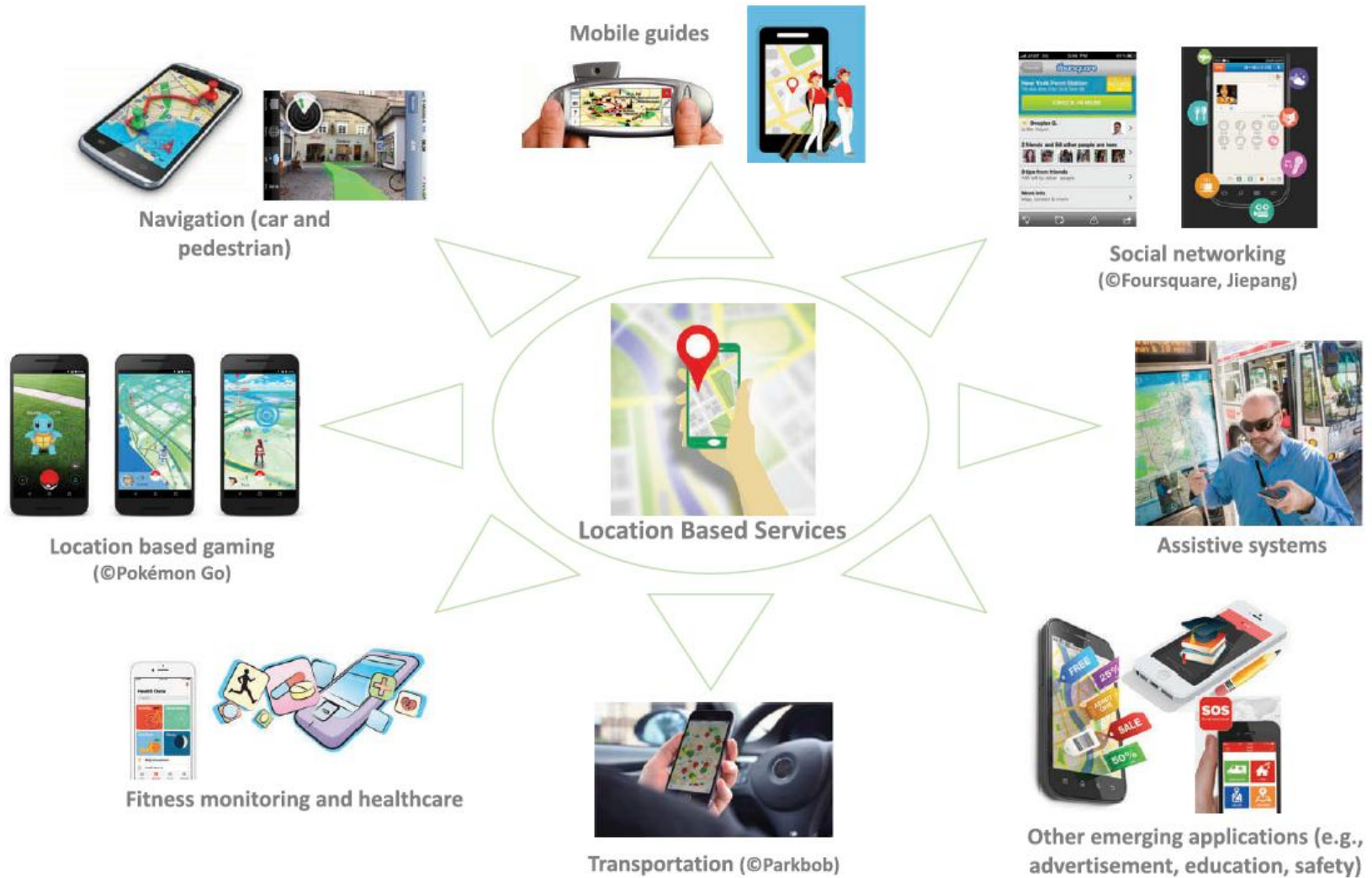

Serviços baseados na Localização

Starting in the late 1990s, LBS apps resulted from the convergence of three different technologies: mobile internet access, global positioning, and advanced graphic interfaces.

The LBS technology market is segmented into several different application uses:

- Navigation
- Search and advertising
- Infotainment
- Tracking
- Games and augmented reality

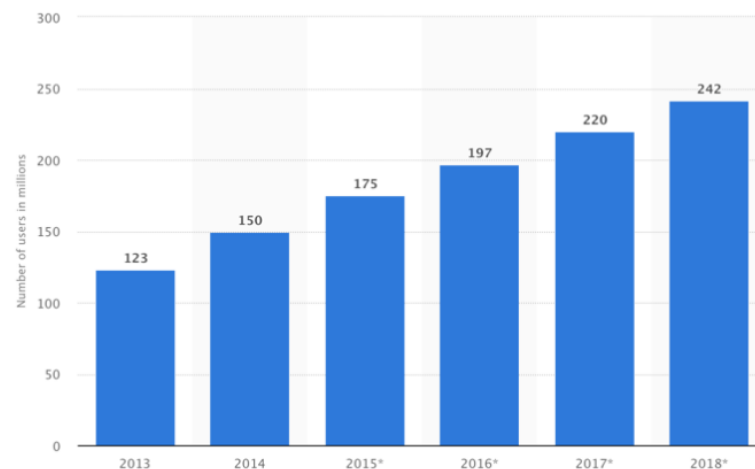

Research from Kantar TNS shows that [navigation is the most popular type of LBS app](#) (46%), followed by finding restaurants (26%), finding friends nearby (22%), checking public transportation (19%), and receiving special deals or offers from retailers (13%).

7 Great Location-Based Services Apps (That Aren't Google Maps)

•1. Foursquare

Foursquare was an LBS app innovator, popularizing the idea of checking into locations through a mobile device (a use that has been replicated by numerous other apps, such as Facebook and Yelp).

•4. Curbside

On Curbside, the process is as follows: the user places an order online, the retailer or restaurant fills the order, the customer gets an alert that the order is ready, the retailer/restaurant gets an alert when the customer arrives, and an employee carries the order out to the customer.

•3. Pokémon Go

•5. Target

•6. Gas Buddy

•2. Dark Sky

Here's a weather app that many will find really useful. Users can select from a number of alert types – precise minute-by-minute updates for rain or snow in their locations, severe weather forecasts with timelines, etc

•7. Uber

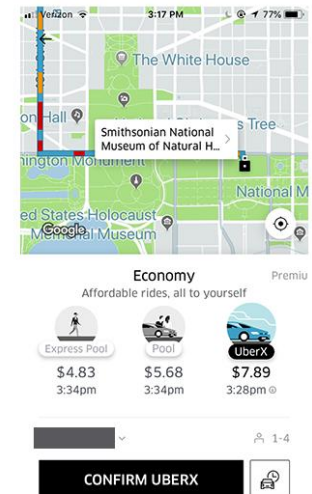



Where matters.

Put the most trusted, independent location data and technology platform to work for your business.



For Marketers

Turn your marketing into real-world visits.



For Developers

Give your software a better sense of place.



For Explorers

Discover the best things to eat, see and do.

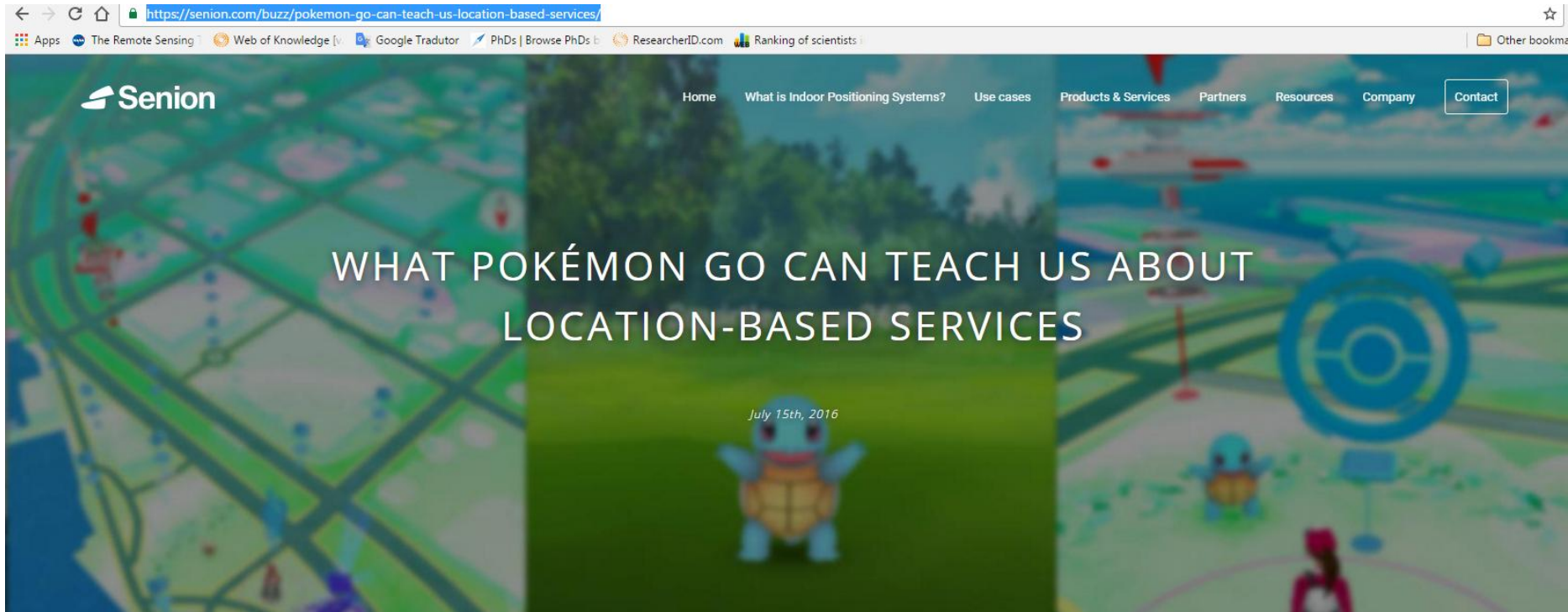

At this stage, I assume few have missed the latest Pokémon craze that has taken the world by storm recently. Originally released on July 6 in the US, Australian and New Zealand markets, the game has quickly become a force to be reckoned with. So what is it and what has it got to do with location?

Europe has launched an initiative to save lives through in-vehicle communication and positioning technology.

FIAMMETTA DIANI, ALBERTO FERNÁNDEZ-WYTENBACH, AND MARCO LISI

Share via:  Slashdot  Technorati  Twitter
 Facebook

On April 28, 2015, the European Parliament voted in favor of an eCall regulation, which requires all new models of passenger cars and light vans that will be certified for the European market to be equipped with the automated emergency-call technology beginning in April 2018. The measure applies to all such vehicles regardless of selling price. In the future, a similar service may be implemented for trucks as well.

eCall was developed to address the problem that drivers involved in accidents often have inaccurate awareness of their location, especially on interurban roads or abroad. In the most crucial cases, victims may not be able to call because they have been injured or trapped, and no witnesses or passers-by may be around to assist them.

The eCall system, which provides the exact location of an accident and requires no subscription, will bring emergency services to crash victims as quickly as possible. In the event of a serious accident, eCall automatically dials 112, Europe's single emergency number.

In addition to the vehicle's exact location — which in many, if not most cases, will draw on

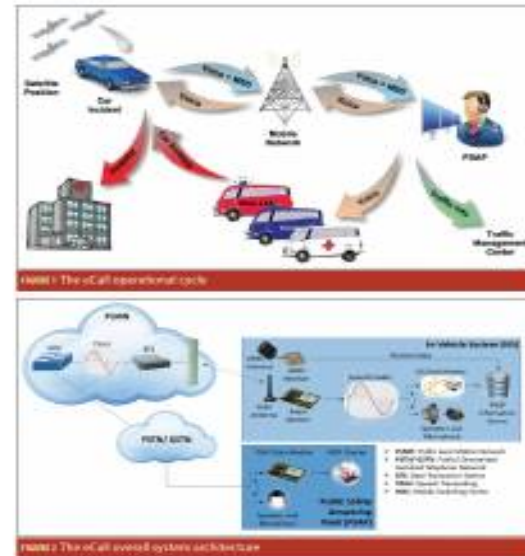

Figures 1 & 2 (Click image to enlarge.)

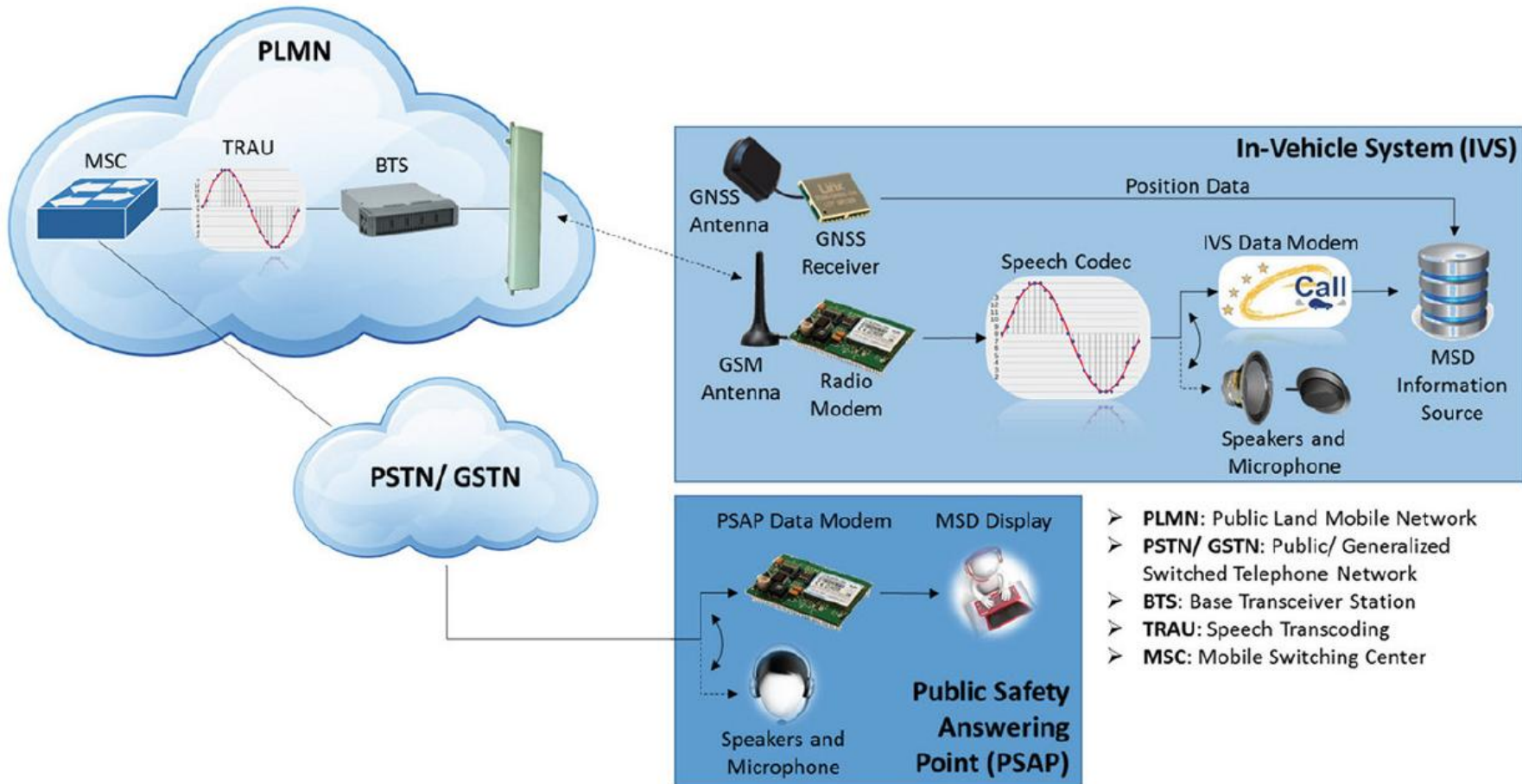
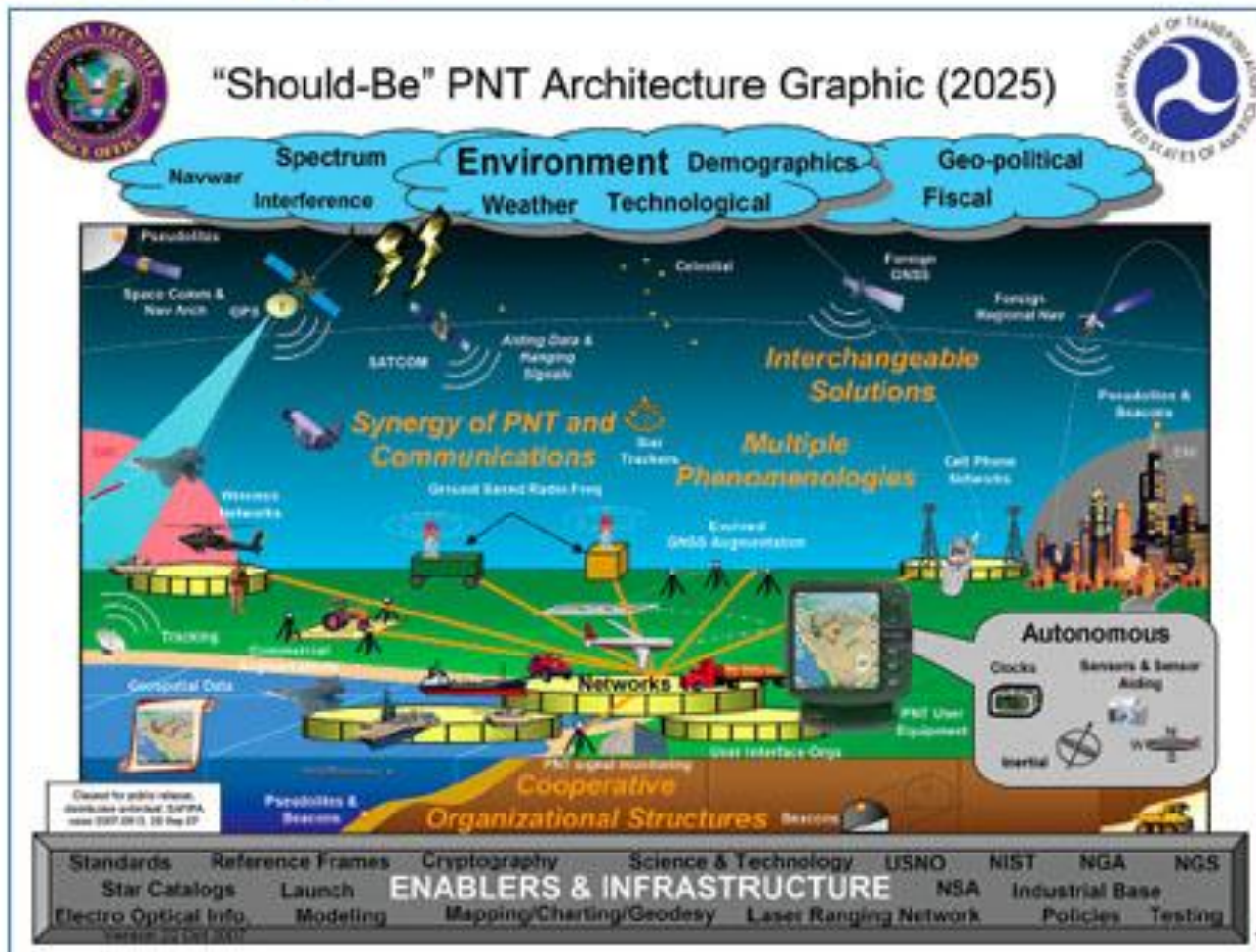

FIGURE 2 The eCall overall system architecture



TLS NovAtel's Thought Leadership Series



Convergência Tecnológica

