

Leica Geosystems Leica Geo Office Online Help



Version 8.4

English

- when it has to be **right**

Leica
Geosystems

Table Of Contents

About LEICA Geo Office (LGO)	1
View Licences	3
Licence Models	5
Check for Version Updates	6
Maintenance	7
LEICA Geo Office Help	9
How to display and use the HTML Help viewer	10
How to use the navigation pane	11
How to use browse sequences	12
How to find a Help topic	13
How to navigate topics	14
How to use full-text search	15
Advanced searching techniques	16
How to print Help text	17
What's this Help	18
Technical Support	19
Tip of the Day	20
GPS Tour I: Real Time	21
GPS Tour I: Real Time	21
GPS Tour I - Lesson 1: Importing Real Time data	22
GPS Tour I - Lesson 2: View and Edit the Real Time data	24
GPS Tour I - Lesson 3: Exporting coordinates to a Custom ASCII file	29
GPS Tour II: Post-Processing	31
GPS Tour II: Post-Processing	31
GPS Tour II - Lesson 1: Importing Raw Data	32
GPS Tour II - Lesson 2: Processing Baselines	34
GPS Tour II - Lesson 3: Importing an ASCII File	36
GPS Tour II - Lesson 4: Calculating Transformation Parameters	37
GPS Tour II - Lesson 5: Exporting coordinates to a user-defined ASCII file	38
GPS Tour III: GIS/ CAD Export	40
GPS Tour III: GIS/ CAD Export	40
GPS Tour III - Lesson 1: Creating a Lookup Table	41
GPS Tour III - Lesson 2: Exporting the DXF file	44
TPS Tour I: Referencing a background image	47
TPS Tour I: Referencing a background image	47
TPS Tour I - Lesson 1: Registering the background image and identifying the common points	48
TPS Tour I - Lesson 2: Matching common points and referencing the image	52
TPS Tour II: Manually updating setups	55

Table Of Contents

TPS Tour II: Manually updating setups.....	55
TPS Tour II - Lesson 1: Importing and inspecting the TPS data of JOB_1.....	56
TPS Tour II - Lesson 2: Importing and inspecting the TPS data of JOB_2.....	61
TPS Tour II - Lesson 3: Manually update a "Set Orientation" setup	65
TPS Tour II - Lesson 4: Importing the TPS data of JOB_3.....	68
TPS Tour II - Lesson 5: Manually update a "Resection" setup	72
TPS Tour III: Automatically updating setups	76
TPS Tour III: Automatically updating setups.....	76
TPS Tour III - Lesson 1: Importing the TPS data of JOB_4.....	78
TPS Tour III - Lesson 2: Automatically update "Set Orientation" setups	81
TPS Tour III - Lesson 3: Exchanging coordinate systems	87
TPS Tour III - Lesson 4: Correcting target heights	90
TPS Tour IV: Shifting, Rotating and Scaling Traverse data	93
TPS Tour IV: Shifting, Rotating and Scaling Traverse data.....	93
TPS Tour IV - Lesson 1: Importing Traverse data	94
TPS Tour IV - Lesson 2: Importing control points from ASCII	97
TPS Tour IV - Lesson 3: Shifting, Rotating and Scaling Traverse Data.....	98
TPS Tour V: Processing a Traverse.....	104
TPS Tour V: Processing a Traverse	104
TPS Tour V - Lesson 1: Importing the data and creating the Traverse.....	105
TPS Tour V - Lesson 2: Processing the Traverse	108
TPS Tour VI: Post-Processing SmartStation Setups	112
TPS Tour VI: Post-Processing SmartStation Setups	112
TPS Tour VI - Lesson 1: Importing and post-processing the SmartStation data	113
TPS Tour VI - Lesson 2: Updating the Setups.....	116
Level Tour: Level-Processing.....	119
Level Tour: Level-Processing	119
Level Tour - Lesson 1: Importing Raw Data	120
Level Tour - Lesson 2: Processing Level Data	121
Level Tour - Lesson 3: Exporting an ASCII File.....	123
Explorer View.....	125
How to use the Explorer-View	125
Tree-View	126
Report-View.....	127
Property-View.....	130
Drag and Drop (Copy & Paste).....	131
Property-Sheets	132
Property Sheets/Pages.....	132
Main and Context Menus	133
Main Menu.....	133
Context-Menu	134

Edit Context-Menu.....	135
List Bar.....	136
List Bar.....	136
List Bar: Management.....	137
List Bar: Tools.....	138
List Bar: Open Documents.....	139
Toolbars.....	140
Toolbars.....	140
Display a Toolbar.....	141
Create a new Toolbar.....	142
Delete a Toolbar.....	143
Customize a Toolbar.....	144
Window Commands.....	145
Window Commands.....	145
Close Window.....	146
Arrange Windows.....	147
Printing.....	148
Print.....	148
Print Preview.....	149
Print Setup.....	150
Project Management.....	151
Project Management.....	151
Notes about Projects.....	152
Create a New Project.....	153
Open a Project.....	154
Delete a Project.....	155
Copy a Project.....	156
Move a Project.....	157
Register a project.....	158
Unregister a project.....	159
Project Properties.....	160
Project Properties.....	160
Project Properties: General.....	161
Project Properties: Coordinates.....	162
Project Properties: Dictionary.....	163
Project Properties: Background Image.....	164
Project Properties: Codelist Template.....	165
Project Properties: CAD Files.....	166
Coordinate System Management.....	167
Coordinate System Management.....	167
Coordinate Systems.....	168

Table Of Contents

Coordinate Systems.....	168
Add a New Coordinate System.....	169
Import Coordinate Systems	170
Delete a Coordinate System	171
Coordinate System Properties	172
Coordinate System Properties	172
Coordinate System Properties: General.....	173
Transformation	175
Transformation.....	175
Classical 2D.....	176
Classical 3D.....	177
One Step.....	178
Two Step.....	180
Stepwise	182
Interpolation	184
Which approach to use	185
Add a New Transformation	186
Delete a Transformation	187
Transformation Properties	188
Transformation Properties.....	188
Transformation Properties: General	189
Transformation Properties: Pre-transformation	190
Ellipsoids	191
Ellipsoids.....	191
Add a New Ellipsoid	192
Delete an Ellipsoid	193
Ellipsoid Properties	194
Ellipsoid Properties.....	194
Ellipsoid Properties: General.....	195
Projections.....	196
Projections	196
Add a New Projection	198
Delete a Projection.....	199
Projection Properties.....	200
Mercator.....	201
Transverse Mercator (TM)	202
Oblique Mercator	203
Universal Transverse Mercator (UTM).....	204
Cassini - Soldner.....	205
Lambert - one Standard Parallel	206
Lambert - two Standard Parallels.....	207

Polar Stereographic	208
Double Stereographic	209
Rectified Skewed Orthomorphic	210
User defined projections	211
File Format of INPUT.USR and OUTPUT.USR	212
Example of a User-written Program	214
State Plane Zones	218
State Plane Zones	218
State Plane Zone Properties	219
How to switch between Projections and State Plane Zones	220
Geoid Models	221
Geoid Models	221
Add a New Geoid Model	222
Delete a Geoid Model	223
Geoid Model Properties	224
Geoid Model Properties	224
Geoid Model Properties: General	225
Geoid Model Properties: Extents	226
How to write your own Geoid Model	227
Compute Geoid Separations	229
Create Geoid Model field file	230
CSCS Models	231
CSCS Models	231
Add a new CSCS Model	233
Delete a CSCS Model	234
CSCS Model Properties	235
CSCS Model Properties	235
CSCS Model Properties: General	236
CSCS Model Properties: Extents	237
Create CSCS Model field file	238
Antenna Management	239
Antenna Management	239
Add a New Antenna	240
Delete an Antenna	241
Import Antenna file	242
Antenna Properties	243
Antenna Properties	243
Antenna Properties: General	244
Antenna Properties: Additional corrections	245
Reference Antenna for phase centre offsets	246
Antenna Height Reading	247

Table Of Contents

Codelist Management	248
Codelist Management.....	248
Codelist	250
Codelist Structure	250
Codelist View	251
Codelist Type.....	252
Codelist Type	252
Codelist Type DNA.....	254
Codelist Type GPS 500.....	255
Codelist Type GPS 900.....	256
Codelist Type SmartWorx	257
Codelist Type TPS 1100	258
Codelist Type TPS 300/ 400/ 800, TS02/06/09	259
Codelist Type TPS 700	260
Create a new Codelist.....	262
Delete a Codelist.....	263
Print a Codelist	264
Register a Codelist.....	266
Unregister a Codelist	267
Codelist Properties.....	268
Example - Codelist.....	269
Code Group.....	270
Code Group	270
Add a New Code Group.....	271
Delete a Code Group.....	272
Code Group Properties	273
Display Code Group.....	274
Example - Code Group	275
Code.....	276
Code	276
Add a new Code	277
Delete a Code.....	278
Code Properties	279
Example - Code	280
Attribute	281
Attribute	281
Add a new Attribute.....	283
Delete an Attribute	284
Attribute Properties	285
Example - Attribute	286
Value Types - Examples (Coding)	287

Satellite Availability	288
Satellite Availability.....	288
Management	289
Satellite Availability: Management	289
Site Properties	291
Import Almanacs.....	292
Create a new Obstruction	293
Import Obstructions.....	294
Export Obstructions	295
Obstruction file format.....	296
Obstruction Properties	297
Availability	298
Satellite Availability: Availability	298
Satellite Availability Report	300
Precise Ephemeris Management	303
Precise Ephemeris Management	303
Precise Ephemeris Import	304
Script Management.....	305
Script Management	305
Script Properties.....	307
Using the Howto Scripts	308
LGO Scripting Help.....	310
LGO Scripting Help Overview	310
The LGO Scripting Object Model	312
Report Template Management	315
Report Template Management.....	315
Report Templates.....	316
Create a new Report Template	318
Delete a Report Template	319
Report Template Properties	320
Report Template Properties	320
Report Template Properties: General	321
Report Template Properties: Contents.....	322
Report Template Properties: Coordinate Types.....	323
Report Template Properties: Format.....	324
Report Template Properties: Header	325
Report Template Properties: Advanced	326
Image Referencing.....	327
Image Referencing	327
Register a background image.....	328
Reference a background image	329

Table Of Contents

- Image Properties 331
- Projects 333
- Google Earth 334
- View / Edit 336
 - View/Edit 336
 - Panning 338
 - Rename Tool 339
- CAD Entities 341
 - Viewing CAD files and managing CAD file layers 341
 - Import CAD file entities 342
 - CAD Entity Properties 344
- Points and Observations 346
 - Point (Coordinate) Classes and Subclasses 346
 - Point Classes and Subclasses (Level) 348
 - New Point (graphical views) 349
 - Delete Points/ Triplets (graphical views) 350
 - Point Properties 351
 - Point Properties (graphical views) 351
 - Point Properties: Setup 352
 - Edit Interval (View/ Edit) 353
 - Re-assign Intervals 354
 - Link or unlink Images 355
 - Observation Properties 357
 - Delete Observations 358
 - Re-assign TPS observations 359
 - Observations View 360
- Graphical Settings 362
 - Graphical Settings (View/ Edit) 362
 - Graphical Settings: View 363
 - Graphical Settings: Accuracy 365
 - Graphical Settings: Color 366
- Re-assign TPS Setups 367
- Re-assign Reference Triplets 368
- Re-assign Measured Triplets 369
- Assign/ Remove points to/from a surface 370
- Show Direction & Distance 371
- Show GPS Loop Misclosure 372
 - Show GPS Loop Misclosure 372
 - Show GPS Loop Misclosure: General 373
 - Show GPS Loop Misclosure: Settings 374
 - Show GPS Loop Misclosure: Report 375

Compute Average Combined Factor.....	376
Shift/ Rotate/ Scale	377
Exchange Coordinate System (Smart Station)	379
Update Reference Triplets	381
Shift Reference Triplet	382
Scroll to a selected Point	383
Select a series of Points / Observations	384
Lines and Areas	385
Lines and Areas	385
Lines/ Areas View	386
New Line/ Area	388
Delete: Lines and Areas.....	389
Line/ Area Properties: General	390
Line/ Area Properties: Thematical Data	392
Point, Line/Area, Setup Properties: Images	393
Add Points to Line/ Border	394
Remove Points from Line/ Border	395
Create arc from previous to next point	396
Convert arc to straights.....	397
Create spline.....	398
Convert spline to straights	399
Link or unlink Images.....	400
Graphical Settings: View.....	402
GPS Processing.....	404
GPS Processing	404
Report View (GPS-processing)	405
Graphical View (GPS-processing).....	406
Zooming (GPS-processing).....	407
Re-assign Intervals.....	408
Delete an interval	409
Export to RINEX.....	410
Select an observation interval for computation.....	411
Select an observation window	412
Select a Satellite Window	414
Processing (GPS).....	416
Processing Modes (GPS).....	417
Results View (GPS).....	418
GPS-processing Parameters.....	419
GPS-Processing Parameters.....	419
GPS-processing Parameters: General.....	420
GPS-processing Parameters: Strategy	422

Table Of Contents

GPS-processing Parameters: Extended Output	426
Auto. Processing Parameters	427
Modify GPS-processing Parameters	429
Properties	430
Display Interval Properties (Track).....	430
Interval Properties (Point): Annotation	431
Interval Properties (Point): Antenna	432
Interval Properties (Track): Annotation	433
Interval Properties (Track): Antenna	434
Point Properties (GPS-proc)	435
Graphical Settings	436
Graphical Settings (GPS-processing)	436
Graphical Settings: General (GPS-proc).....	437
Graphical Settings: Styles and Colors (GPS-proc)	438
TPS Processing	439
TPS-Processing	439
Calculate geometrical PPM	442
Calculate atmospherical PPM	443
Exchange Coordinate System (Smart Station)	444
Setups	446
Create a Setup Application	446
Delete a Setup Application.....	448
Edit a Setup Application.....	449
Allow automatic update.....	450
Update Setups	451
Setup Report.....	452
TPS Processing Guide.....	456
Setup Properties	457
Setup Properties.....	457
Setup Properties: General.....	458
Setup Properties: Observations (Resection, Multiple Backsights, Height Transfer)	460
Setup Properties: Observations (Set Orientation, Known Backsight)	462
Point, Line/Area, Setup Properties: Images	463
Traverses	464
New Traverse	464
Delete a Traverse	465
Traverse Report.....	466
Traversing techniques.....	470
Traverse-processing Parameters.....	474
Traverse-processing Parameters	474
Traverse-processing Parameters: Traversing	475

Traverse-processing Parameters: Angle Balance	476
Traverse-processing Parameters: Height Balance	477
Modify Traverse Processing Parameters	478
Traverse Properties	479
Traverse Properties	479
Traverse Properties: General	480
Traverse Properties: Check Points	482
Traverse Properties: Stations	483
Traverse View	484
TPS-Processing: Traverse View	484
Zooming (Traverse-processing)	486
Sets of Angles	487
Create a Sets of Angles Application	487
Delete a Sets of Angles Application	489
Sets of Angles Report	490
Sets of Angles Tolerances	493
Sets of Angles Properties	494
Sets of Angles Properties	494
Sets of Angles Properties: General	495
Sets of Angles Properties: Targets	496
Graphical Settings	497
Graphical Settings (TPS-processing)	497
Graphical Settings: View	498
Graphical Settings: Color	499
Level Processing	500
Level-Processing	500
Level-Processing: Jobs Report View	502
Level-Processing: Lines Report View	503
Join Level Lines	505
Processing Level lines	506
Booking Sheet	507
Level-Processing: Booking sheet	507
Level observation techniques	511
Point Classes and Subclasses (Level)	515
Changing Point Classes in the Booking Sheet	516
Create/ Delete Control (Level)	517
Reset Heights	518
Activate/ De-activate Points and Observations in the Booking Sheet	519
Modify Point Heights in the Booking Sheet	522
Modify Point Ids in the Booking Sheet	523
Edit Level Standard Deviations	524

Table Of Contents

Level Line View	525
Level Processing: Level Line view	525
Zooming (Level-Processing)	526
Vertical Exaggeration	527
Graphical Settings	528
Graphical Settings (Level-Processing)	528
Graphical Settings: View	529
Graphical Settings: Color	530
Level-processing Parameters	531
Level-processing Parameters	531
Level-processing Parameters: Level Line	532
Level-processing Parameters: Observations	533
Level-processing Parameters: Point Heights	534
Level-processing Parameters: Staff Corrections	535
Modify Level-processing Parameters	536
Adjustment	537
Adjustment	537
Panning	539
Zoom In	540
Zoom Out	541
Zoom 100%	542
Points and Observations	543
New: Point, Setup, Observation (Adjustment)	543
New Point (graphical views)	544
New Setup	545
New Observation	546
Point Properties	547
Point Properties (graphical views)	547
Point Properties: Setup	548
Observation Properties	549
Observation Properties	549
Observation Properties: GPS	550
Observation Properties: RTK Info	551
Observation Properties: TPS	552
Observation Properties: Azimuth	554
Observation Properties: Level	555
Observations View	556
Activate / De-activate Points, Setups and Observations (graphical views)	558
Delete: Point, Setup, Observation	559
Delete Points/ Triplets (graphical views)	560
Delete Setups	561

Delete Observations	562
Pre-analysis	563
Compute Network	564
Compute Loops	565
Graphical Settings.....	567
Graphical Settings (Adjustment).....	567
Graphical Settings: View	568
Graphical Settings: Accuracy	570
Graphical Settings: Grid	571
Graphical Settings: Color	572
Graphical Settings: Font.....	573
Using the Design capabilities	574
Note on adjusting GPS and Terrestrial measurements.....	575
Configuration	576
Configuration Adjustment.....	576
General Adjustment Parameters.....	577
General Adjustment Parameters	577
General Parameters: Control	578
General Parameters: Standard Deviation.....	580
General Parameters: Centring / Height	581
General Parameters: Known Station.....	582
General Parameters: Test Criteria.....	583
General Parameters: Coordinate System.....	584
Terrestrial Adjustment Parameters	586
Terrestrial Adjustment Parameters.....	586
Terrestrial Parameters: Vertical refraction coefficient.....	587
Terrestrial Parameters: Azimuth offset	588
Terrestrial Parameters: Scale factor correction	589
Data Creation Parameters of Adjustment	590
Data Creation Parameters of Adjustment.....	590
Data Creation: Observation.....	591
Data Creation: Setup.....	592
Results	593
Results.....	593
Adjustment Pre-analysis Report	594
Adjustment Network Report	596
Adjustment Loops Report	604
All about Adjustment.....	607
All about Adjustment.....	607
Introduction	608
Relationship between Adjustment, Precision, Reliability and Testing	609

Table Of Contents

Quality Control in Network Planning	610
Least Squares Adjustment.....	612
Least Squares Adjustment	612
Least Squares Adjustment: General remarks.....	613
Mathematical Model	614
Stochastic Model	616
Free and Constrained Adjustments	618
Formulae	619
Precision and Reliability.....	621
Precision and Reliability	621
Precision and Reliability: General remarks.....	622
Precision	623
Reliability	624
Statistical Testing.....	625
Statistical Testing	625
Statistical Testing: General remarks.....	626
F-Test.....	627
W-Test.....	628
T-Test.....	629
Antenna Height-test.....	630
Interpreting Test Results	631
Estimated Errors.....	632
Points.....	633
Points View.....	633
Configure the Points View	634
Add a New Point to the Points View	636
Point Properties.....	637
Point Properties (Points View)	637
Point Properties: All	638
Point Properties: General.....	640
Point Properties: Stochastics	642
Point Properties: Thematical Data	643
Point Properties: Reliability	644
Point Properties: Mean	645
Point, Line/Area, Setup Properties: Images	646
Point Properties: Hidden Points	647
Hidden Point (Position).....	648
Hidden Point (Height).....	650
Point Editor.....	651
Modifying Point Items	652
Modifying Point Codes.....	653

Modifying Point Classes in the Points View	654
Point (Coordinate) Classes and Subclasses	655
Point Classes and Subclasses (Level)	657
Activate / De-activate Points (Points View).....	658
Delete Points/ Triplets (Points View)	659
Shift/ Rotate/ Scale.....	660
Shift/ Rotate/ Scale	660
Shift/ Rotate/ Scale Wizard - Start	662
Shift/ Rotate/ Scale Wizard - Shift.....	663
Shift/ Rotate/ Scale Wizard - Rotation.....	664
Shift/ Rotate/ Scale Wizard - Scale	665
Shift/ Rotate/ Scale: Transformation parameters	666
Shift/ Rotate/ Scale Wizard - Common Points	667
Shift/ Rotate/ Scale Wizard - Transformation parameters.....	668
Shift/ Rotate/ Scale Wizard - Finish Transformation	669
Exchange Coordinate System (Smart Station)	670
Rename Tool.....	672
Move / Copy Points	674
Notes about Drag and Drop (Copy & Paste) Points	675
Modifying Reference Coordinates	676
Surfaces.....	677
Surfaces	677
Assign/ Remove points to/from a surface	680
Activate/ De-activate points	681
Include/ Exclude triangles.....	682
Breaklines.....	683
Boundaries	685
Surfaces: 2D View	688
Surfaces: 3D View	690
Surfaces: Points View.....	692
Graphical Settings	693
Graphical Settings (Surfaces).....	693
Graphical Settings: View	694
Graphical Settings: Color	695
Surface Results	696
Surface Report	697
Create a Difference Surface	700
Exporting Surfaces	701
Antennas.....	702
Antennas View	702
Antenna Management	703

Table Of Contents

Results	704
Results View (GPS).....	704
Results View (Level).....	705
Results Configuration	706
Keep a Processing Run.....	707
Delete a Processing Run.....	708
View Configuration	709
Configure a Report	710
GPS Results	711
GPS-Processing Results: Baseline.....	711
GPS-Processing Results: Points.....	713
Selection Criteria.....	714
Default Selection Criteria	715
GPS-Processing Parameters.....	716
GPS-processing Reports	717
GPS Processing Report: Summary.....	718
GPS Processing Report: Baselines	724
GPS Processing Report: Kinematic	735
GPS Processing Report: SPP.....	746
GPS-Processing Analysis Tool	754
Store the GPS-Processing Results	756
Level Results	757
Level-Processing Results: Points.....	757
Level-processing Parameters	758
Level Processing Report: Summary.....	759
Store the Level-Processing Results	763
Codelists	764
Codelist View.....	764
Codelist Management.....	765
Images	767
Images.....	767
Import Images	770
Link or unlink Images.....	771
Import.....	773
Raw Data	774
Raw Data Import	774
Standard GSI Word Indexes.....	776
How to Import GPS Raw Data	778
How to Import TPS Raw Data	780
How to Import TDS Raw Data	782
TDS raw data format	783

How to Import Level Raw Data	784
Merging Reference Coordinates during Import.....	785
Import Settings (TPS/ Level)	786
Import Settings (TPS/ Level).....	786
Import Settings: Coding	787
Import Settings: Standard Deviations.....	788
Import Settings: Centring/ Height.....	789
GSI Operation Codes.....	790
Assign Settings.....	793
View Data (GPS)	796
View Data (TPS).....	797
View Data (Level)	798
View Data (Points).....	799
Fieldbook Report	800
ASCII Data	805
ASCII Import.....	805
Notes about importing Points	806
SKI ASCII File Import	807
Text File Import	808
User Defined ASCII File Import Wizard	809
User Defined ASCII File Import Wizard.....	809
Delete Text File Import Templates	811
Save Text File Import Templates as a File.....	812
Import Text File Import-Templates from a File	813
SKI ASCII File Format	814
Precise Ephemeris.....	815
Precise Ephemeris Import	815
How to Import Precise Ephemeris	816
Internet Download	817
Precise Ephemeris Management	818
Export.....	819
RINEX.....	820
RINEX File Export	820
ASCII.....	821
ASCII Export.....	821
SKI ASCII File Export	822
SKI ASCII File Format	823
SKI ASCII File Format.....	823
SKI ASCII Point Coordinate Format.....	824
SKI ASCII Baseline Vector format.....	828
SKI ASCII Export Settings	829

Table Of Contents

User-defined ASCII File Export	831
User-defined Export Settings.....	832
ASCII Export Settings: Classes	835
User-defined Export Templates	836
Add User-defined Export Template.....	836
Delete User-defined Export Template.....	837
Save User-defined Export Template to a File	838
Load User-defined Export Template from a File	839
NGS B- and G-file Export	840
NGS B- and G-file Export Settings	842
Custom ASCII File Export.....	844
Custom ASCII Export Settings	845
FBK Files	847
FBK File Export	847
FBK File Export Settings	848
GIS/CAD	849
GIS / CAD file Export.....	849
GIS / CAD Export Settings	850
GIS / CAD Export Settings: AutoCAD, MicroStation.....	852
Lookup Table.....	853
Lookup Table	853
Add a new Lookup-Table	854
Modify a Lookup-Table	855
Modify a Lookup-Table: Code Defaults.....	856
Delete a Lookup-Table.....	857
Load Lookup-Table from a file	858
Save Lookup-Table as a file	859
Shape files	860
Shape File Export	860
Shape File Export Settings	861
LandXML files	863
LandXML File Export	863
LandXML File Export Settings	864
Compute Geoid Separations	865
Compute Hidden Points	866
Create Geoid Model field file.....	867
Create CSCS Model field file	868
Mean Coordinates & Differences Report.....	869
Coordinate Comparison Report	871
Internet Download.....	873
Internet Download	873

Internet Download: General.....	874
Internet Download: Site logfile.....	876
Internet Download: Add/ Edit custom sites.....	877
Importing after Internet Download.....	878
Filters.....	879
Filters.....	879
Filters: General.....	880
Filters: Quality/ Time.....	881
Datum / Map.....	882
Datum/Map.....	882
Notes about Transformation.....	883
Which approach to use.....	884
Selection View.....	885
Selection View.....	885
Match View.....	886
Match View.....	886
Minimum Requirements for Coordinates.....	887
Match common points.....	889
Activate/ De-activate common points.....	890
Delete common points.....	891
Select Point Type of common points.....	892
Configuration of transformation type.....	893
Configuration: General.....	894
Configuration: Outliers.....	896
Configuration: Parameters.....	897
Classical 2D.....	898
Classical 3D.....	899
One Step.....	900
Two Step.....	902
Results View.....	904
Results (Datum/ Map).....	904
Configuration: Outliers.....	905
Store Transformation Parameters.....	906
Change Coordinate Type of Residuals.....	907
Display Absolute Values of Residuals (Datum / Map).....	908
Chart.....	909
Chart.....	909
Print a chart.....	910
Copy a chart to the clipboard.....	911
Save a chart to a file.....	912
Report.....	913

Table Of Contents

Report View (Datum/ Map)	913
COGO Calculations	918
Cogo Calculations	918
Graphical Settings	921
Graphical Settings (Cogo).....	921
Graphical Settings: View.....	922
Graphical Settings: Color	923
Cogo Calculations: Intersections	924
Cogo Calculations: Line Calculations	926
Cogo Calculations: Arc Calculations.....	928
Cogo Calculations: Traverse	931
Cogo Calculations: Inverse.....	932
Cogo Calculations: Area Division	933
COGO Report.....	935
Data Exchange Manager	938
Data Exchange Manager.....	938
Object Properties.....	940
New Folder	941
Rename a file or folder	942
Delete a file or folder	943
Refresh.....	944
View/ Hide objects	945
View the contents of a file.....	946
Locations	947
DXM location: My Computer	947
DXM location: Local Memory (SD-card, CF-card, PC- card, USB stick).....	948
DXM locations: Serial ports/ USB	949
Settings	950
DXM Settings.....	950
DXM Settings: General	951
DXM Settings: COM/USB Settings	953
Upload/ Download	954
Uploading objects to the instrument.....	954
Downloading objects from the instrument	956
Uploading files to the instrument.....	957
Downloading files from the instrument	958
Import/Export Backup	959
Send To	960
Transfer objects.....	962
Transfer Objects of the Office database	962
Transfer Objects of the Instrument.....	963

Transfer objects: Jobs.....	964
Transfer objects: Projects	965
Transfer objects: Coordinate Systems	966
Transfer objects: Antennas	967
Transfer objects: Codelists	968
Transfer objects: Format files	969
Transfer objects: Geoid model field files	970
Transfer objects: CSCS model field files.....	971
Transfer objects: Configuration sets	972
Transfer objects: Road jobs (SmartWorx).....	973
Transfer objects: DTM jobs (SmartWorx).....	974
Software Upload	975
Software Upload.....	975
Internal Memory	976
System Memory	977
Local memory devices.....	978
Software Installation Wizard.....	979
Software Installation Wizard - Select Instrument class and Connection	980
Software Installation Wizard - Select Software Type.....	981
Software Installation - Sensor/ System Firmware.....	983
Software Installation - Current Selection	984
Software Upload: View Applications and System (TPS1000/ 1100, RCS1100)	985
Design to Field	986
Design to Field	986
Importers	988
Importer Management	990
Design to Field: Graphical View	991
Design to Field: Graphical Settings	993
Design to Field: Creating an on-board job	994
Connection Editor.....	996
Design to Field: Connection Editor.....	996
Connection Editor: Selecting layers	998
Navigating through cross-sections.....	999
Connecting vertices	1000
Glossary of Road Terms	1001
Tunnel Profile Editor.....	1004
Design to Field: Tunnel Profile Editor.....	1004
Tunnel Profile Editor: Viewing and creating tunnel profiles.....	1006
Tunnel Profile Editor: Viewing and creating layers.....	1008
Tunnel Profile Editor: Viewing and creating profile rotation tables	1009
Customize	1010

Table Of Contents

- Customize..... 1010
- Reset a Toolbar..... 1011
- Options..... 1012
 - Options..... 1012
 - Options: General 1013
 - Options: Units/ Display 1014
 - Options: Default Parameters 1015
 - Options: Internet..... 1017
 - Options: Linework..... 1018
 - Options: PZ-90 1019
 - Options: CAD Import 1020
- Messagebox Management 1021

About this Software

About LEICA Geo Office (LGO)

With LGO you can **import**, **export** and **manage** GPS, TPS and Level data.

The following management components are available:



Project Management



Coordinate System Management



Antenna Management



Codelist Management



Satellite Availability



Precise Ephemeris Management



Script Management



Report Template Management



Image Referencing

You can view and edit and **process** GPS, TPS and Level data.

You can adjust data, calculate Surfaces and Volumes, view Images imported with SmartWorx jobs and perform COGO calculations.

It offers you tools like:



Datum and Map



Format Manager



Data Exchange Manager



Software Upload



Design to Field

Read about **Version number** and **Build**, the **Release date** and the Maintenance end of your version in the **About...** dialog, where you will additionally get information on the copyright and be able to read legal and licensing notices on LGO.

- Open the dialog via the **Help** main menu.

For detailed information on the software version and your operating system press the corresponding buttons:

[System Info...](#)

Information on your operating system is displayed.

Information of this kind helps clarifying problems you might encounter with running the software on your operating system.

[Version Info...](#)

Detailed information on the DLLs used by LGO is given.

Information of this kind helps clarifying problems with affected or lost DLLs, or wrongly set pathes.

Note:

- Parts of LGO make use of the 7-Zip program which is licensed under the GNU GPL (www.7-zip.org).
- Parts of LGO make use of the FreeImage library which is licensed under the FreeImage Public License (freeimage.sourceforge.net).

View Licences

LGO and FlexOffice are protected software and several options are available individually to be included in your licence:

- GNSS-processing
- TPS-Processing
- Level-processing
- Adjustment
- Datum and Map
- Surfaces and Volumes
- Cogo Calculations
- RINEX Import
- LandXML Import/Export
- GIS / CAD Export

The **View Licences** dialog enables you to display the products and options which are currently activated for your entitlement. You may view node locked licences activated on your PC as well as floating licences activated on a local licence server.

- Open the **Help** main menu and select **View Licences...** to invoke the **View Licences** dialog.

General:

Entitlement Id:

Shows the unique, product-specific licence key that must be entered when installing the software. The Id consists of the licence number, the initial order number of the software and a verification number. The Entitlement Id stays the same even if additionally purchased options are added later or your software maintenance as part of a Customer Care Package (CCP) is updated.

Licensed products and options:

Lists the **products** (the basic *LGO Licence* and the *Maintenance*) and **options** included in your licence. You are informed on the **License Model**, which can be either *node locked* or *floating*, on the **License Type**, which can be *perpetual* or *expiring*, and if expiring on the **Expiration Date**.

Borrowing:

Floating licences, i.e. licences activated on a local licence server and shared across a local network, may be borrowed to be used on a computer disconnected from the LAN. A licence can only be borrowed **when the basic LGO Licence is available and with all features included**. You cannot borrow single features (i.e. options). A **date** until when the licence shall be borrowed has to be specified. By default a period of 14 days is set. After that the licence is automatically returned.

Borrowed licences can also be manually returned by selecting **Return borrowed licences**. The licence including all options will be returned to the Licence server specified under **Settings**.

Licence updates:

If you are working with a **node locked** installation of LGO you may select **Check for Licence updates** to see whether additionally purchased software options or an update for your software maintenance are available to be **activated** for your **Entitlement Id**.

If you are working as a client with a **floating** licence of LGO you may select **Check for Licence updates** to see whether additionally purchased software options or an update for your software maintenance are available but you will have to **activate** the updates **on your local licence server**.

Settings:

Licence Server configuration:

If you have purchased a floating licence which has been activated on your local licence server and installed LGO as a client on your PC then the name of the licence server, which you have had to specify during the client installation and activation already, is shown under **Host**, e.g. *@myserver*.

If the server changes you have to specify the new server here.

Proxy Server configuration:

If you have purchased a network licence and if you access to the licence server via the Internet using a Proxy server then you will see the configuration details here. Again the details for the proxy server have to be specified during the client installation and activation already. If these details change, e.g. with a new server, then you must specify the new configuration here.

You **need not** fill in any information if a licence server in a **Local Area Network** (LAN) is used.

Note:

- If you want to return your licence for **re-hosting** make sure that all borrowed products and options have been returned to the local licence server before.
- For detailed information on the installation and activation of Licences, please, refer to the **Leica Geosystems Software Licensing.pdf** which is available on your installation DVD.

Licence Models

For LGO you have the choice between two different Licence Models matching different user requirements:

- Node locked
- Floating

Node locked licences are tied to a single PC whereas **Floating** licences can be shared between multiple users working on different PCs within the same network.

Node locked licences:

A **Node locked** licence is tied to a single PC and is, therefore, the ideal choice for working remotely or for single dedicated users within a network. It cannot be shared by multiple users within the same network and is usually not transferred from one PC to another ("Rehosting").

To manage node locked licences on a PC open the [View Licences](#) dialog from within LGO.

Floating licences:

Floating licences can be shared across multiple client workstations within the same local network and are, therefore, the ideal choice if the software shall be "floated" over a local network, transferring from one client workstation to the next as required.

Floating licences are managed by a local licence server running in the local network. This local licence server manages the licence pool and controls that the number of simultaneously used licences does not exceed the total number of purchased licences. If no more licences are available, the user is notified and has to wait until another user finishes using a licence.

The local licence server can be installed on either a normal PC or a dedicated server, but it cannot be installed on a "virtual" computer or server system. Usually the licence is not transferred from one local licence server to another ("Rehosting").

If it is required to use the software remotely on a PC or notebook without connection to the network and the local licence server it is possible to "borrow" licences from the local licence server and to "return" them after usage ("Borrowing").

To manage floating licences on the local licence server make use of a separate Licence Management Tool, the **CLM Administrator Server**.

To manage your licences while you are working on a local client open the [View Licences](#) dialog from within LGO.

Note:

- For detailed information on the different Licence models and on how to manage licences on a PC, a server or a client, please, refer to the [Leica Geosystems Software Licensing.pdf](#) which is available on your installation DVD

Check for Version Updates

When you start up LGO a check will be made whether a newer version is available for download. You may also invoke this check manually by selecting **Check for updates...** from the Help main menu.

In the so-called Update notification you are informed on:

- the available update itself (**Update Information**):
the build number of the LGO version that is currently installed on your computer is given together with the build number of the newly available version.
- the required **Maintenance**:
the date is indicated until which your **Maintenance** has to be valid for you to be entitled get free access to the new version. Additionally, the date when your current maintenance expires is given together with a link to the Leica Geosystems Sales and Support Network via which you might order an update for your maintenance.

To download the new version:

- Press the **Download** button and you will be redirected to the Leica myWorld website from which you may download the new version in your language.
- Press **OK** to close the Update notification without downloading the new version.

Maintenance

LEICA offers **Maintenance** for your purchased product. Contact your Leica dealer or representative on how to order Maintenance for LEICA Geo Office or FlexOffice. Maintenance is part of your Customer Care package and of your **Entitlement** to activate and use LGO or FlexOffice. Maintenance is valid for a pre-defined period of time. Valid maintenance will give you free access to new versions released before the **Expiration Date**.

Your maintenance can be updated from within the [View Licences](#) dialog. In this dialog select **Check for License Updates**.

Getting Help

LEICA Geo Office Help

The Online Help for Leica Geo Office (LGO) provides information about using the features of the software as well as step-by-step tutorials to guide you through the programs' basic functionality. The Help System is a very comprehensive reference and includes all the detailed information about the whole software package.

[How to display and use the HTML Help viewer](#)

[How to use the navigation pane](#)

[How to use browse sequences](#)

[How to use full-text search](#)

[How to navigate topics](#)

[How to print Help text](#)

[What's this Help](#)

The help system is designed to open in the HTML Help viewer — Microsoft's help window for viewing compiled HTML Help. If you do not have the HTML Help viewer components installed on your system, you can view it with Microsoft's Internet Explorer browser (use version 4.x or later for complete functionality).

About the online tutorials:

To help you get started with the basics of working with LGO, the online help includes "Getting Started" tutorials. You can open them by selecting GPS or TPS or Level Tutorial from the Table of Contents. These tutorials are designed for viewing in the HTML Help viewer (or Internet Explorer 4.x or later), but may also be printed.

Related Topics:

[Technical Support](#)

How to display and use the HTML Help viewer

To display the online help in the HTML help viewer go to the **Help** main-menu and select **Contents and Index**.

How to use the HTML Help viewer:

The HTML Help viewer is a tri-pane window presenting you with a navigation pane to the left and a pane for displaying help contents and selecting browse sequences on the right. The Contents tab is synchronized with the topic pane, so that users never lose their place.

Left-hand tabs

Depending on how you prefer to work you can open or close the left-hand tabs in the navigation pane. When you hide the navigation pane, the right-hand topic pane is maximized so you can see as much topic content as the size of the HTML Help viewer allows.

- To close the left-hand tabs from view click **Hide**



- To open the left-hand tabs click **Show**

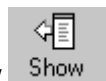

Navigation:

Just like within an Internet browser, the HTML Help viewer offers you **Back** and **Forward** buttons for returning to a previously viewed topic:

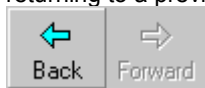

To learn more about how to navigate with the help of the left-hand navigation pane tabs see:

[How to use the navigation pane](#)

Options menu:

The Options button opens a menu with selections for showing/ hiding the navigation pane, going back and forward to previously viewed topics, stopping a topic or Web page from loading and refreshing the information displayed in the topic pane. You may also access Internet options from this menu, print topics or turn search highlighting on or off.

Leica-Geosystems Web site:

Since the HTML Help viewer uses components of the Internet Explorer browser, it can take you directly to Web sites on the Internet.



- Click  to visit the Leica-Geosystems homepage.



How to use the navigation pane

The Online Help includes the following left-hand tabs in the navigation pane:

Contents:

The Contents tab displays a table of contents. Books  and pages  represent the categories of information in the online help system. When you double-click a closed book, it opens  to display its content (sub-books and pages). When you double-click an open book, it closes. When you click pages, you select topics to view in the right-hand pane of the HTML Help viewer.

Index:

The Index tab displays a multi-level list of keywords and keyword phrases. The keywords are associated with their corresponding topics. In contrast to the pre-structured **table of contents**, the keywords are intended to direct you to specific topics according to your way of working. To open a topic in the right-hand pane associated with a keyword, select the keyword and then either click **Display** or **double-click the keyword**. If the keyword is used with more than one topic, a **Topics Found dialog** opens so that you can select a specific topic to view.

Search:

The Search tab enables you to search for words in the help system and locate topics containing those words. Full-text searching looks through every word in the Online Help to find matches. When the search is completed, a list of topics is displayed so you can select a specific topic to view.

Since the Help system contains an [advanced search functionality](#), there are also options to search previous results, find similar words and/ or search only topic titles. Phrases to be searched for may be combined by logical operators.

Favorites:

The Favorites tab enables you to store a list of your favorite or most frequently used help topics. Whenever you open the Online Help system, you can quickly go to the topics you view most often by selecting them from this tab. To add topics as favorites simply click **Add** when an interesting topic is displayed in the right-hand pane. You can update the list at any time by removing topics you no longer want to mark as favorites.

How to use browse sequences

The Online Help system includes a special way of navigating with browse sequences. They are intended to guide you through a pre-defined series of topics.

The HTML Help viewer includes browse sequence buttons for topic navigation.

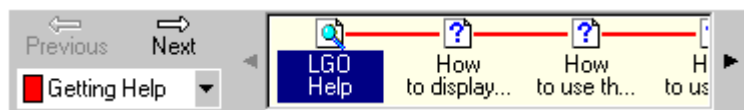

- To go to the next topic, click **Next** .
- To go to the previous topic, click **Previous** .

The HTML Help viewer also includes a drop-down list of browse sequences and a browse sequence bar with small icons that represent the topics used with each browse sequence. You can also use this list or browse sequence bar to navigate topics.

How to find a Help topic

- Click the **Contents** tab to browse through topics by category.
- or click the **Index** tab to see an alphabetically ordered list of index entries: either type the word you're looking for or scroll through the list.
- or click the **Search** tab to search for words and/ or phrases that may be contained in a Help topic. Combine several phrases by logical operators for a more advanced search.

How to navigate topics

Topics in the Online Help include a variety of navigation components including:

Drop-down hotspots:

Some topics include drop-down hotspots. A drop-down hotspot is clickable text that displays more information in a drop-down list. These drop-downs provide a quick way for you to get information about doing tasks without having to do a lot of scrolling. You only need to click the hotspots you want to read. To close the text, click the hotspot again.

- [Drop-down hotspot sample \(click to view drop-down text\)](#)

This is how text is displayed when you click a drop-down hotspot. Click the drop-down hotspot again to close the drop-down text.

Links to popup windows:

With some links, the destination topic opens in a popup window right on top of the topic pane. It appears like having two windows in one, only the focus is on the information in the popup window. When you finish reading the information in the popup window, you can close it from view or navigate to any of its links.

- [Link to popup window sample \(click inside the popup window to close it\)](#)

Browse sequences:

The HTML Help viewer includes special navigation for [using browse sequences](#). They are intended to guide you through a series of topics. The viewer includes a browse sequence bar and browse sequences navigation buttons for browsing topics.

How to use full-text search

1. To find information with **advanced full-text search** click the **Search tab** and type the word or phrase you want to find.
 - To search only topic titles select **Search titles only**.
 - To find words similar to your search term select **Match similar words**.
 - To narrow your search select **Search previous results**.
 - To highlight all instances of search terms that are found in topic files click **Options** and select **Search Highlight On**.
2. Click  to add boolean operators to your search. The AND, OR, NOT, and NEAR operators enable you to precisely define your search by creating a relationship between search terms. If no operator is specified, AND is used.
3. Click **List Topics**, select the topic you want, and then click **Display** or double-click the topic.
4. To sort the topic list, click the **Title**, **Location**, or **Rank** column heading.

Note:

- Searches are not case-sensitive, so you can type your search in uppercase or lowercase characters.
- You may search for any combination of letters (a-z) and numbers (0-9).
- Punctuation marks such as the period, colon, semicolon, comma, and hyphen are ignored during a search.
- Group the elements of your search using double quotes or parentheses to set apart each element. You cannot search for quotation marks.
- **For example:** If you are searching for a file name with an extension, you should group the entire string in double quotes: "filename.ext". Otherwise, the period will break the file name into two separate terms. The default operation between terms is AND, so you will create the logical equivalent to "filename AND ext."

See also:

[Advanced searching techniques](#)

Advanced searching techniques

The following techniques help you to narrow your searches for more precise results.

Wildcard expressions:

You can search for words or phrases using wildcard expressions. Wildcard expressions allow you to search for one or more characters using a question mark or asterisk.

Boolean operators:

The AND, OR, NOT, and NEAR operators enable you to precisely define your search by creating a relationship between search terms. If no operator is specified, AND is used.

Nested expressions:

Nested expressions allow you to create complex searches for information. For example, "projects AND ((GPS OR Level) NEAR import)" finds topics containing the word "projects" along with the words "GPS" and "import" close together, or containing "projects" along with the words "Level" and "import" close together.

The basic rules for searching help topics using nested expressions are as follows:

- You can use parentheses to nest expressions within a query. The expressions in parentheses are evaluated before the rest of the query.
- If a query does not contain a nested expression, it is evaluated from left to right.
- You cannot nest expressions more than five levels deep.

How to print Help text

You can print topics and information right from the HTML Help viewer. The available print options are determined by the version of Internet Explorer installed on your system.

To print a single topic:

1. Click **Print**.
2. Select **Print the selected topic** and click **OK**.

To print all topics in a selected book:

1. Click **Print**.
2. Select **Print the selected heading and all subtopics** and click **OK**.

Tip/ Note:

- If a topic includes drop-down hotspots, click the hotspots to display the information before you print.
- Only from the **Contents** tab you may select to print entire books.
- If you open a topic via the **Index**, the **Search** functionality or as one of your **Favorites**, only single topics may be printed at once. You may decide on Print all linked documents, Print table of links and Print to file.

What's this Help

As you work in the office software and create your own projects, you can obtain information about windows or dialogs by using the context-sensitive help available in the application. You can access this help in several ways, including:

Dialogs: Dialogs display a question mark  in the upper-right corner to indicate that they provide Help. Click the question mark and a topic opens in the HTML Help viewer that explains how to use the fields and controls in the dialog. You can also press **F1** at dialogs to get help.

Windows: From any window, press **F1** to get more information about using it.

Alternatively:

- Select **What's This?** from the **Help** menu or use **Shift-F1**.

Technical Support

Technical information is available through several online services. All registered Leica Geosystems customers have access to this information. You can obtain product support in several ways:

World Wide Web

The Leica Geosystems Web Site www.leica-geosystems.com provides unlimited access to a variety of company services and product information.

Email, Fax

Contact the Leica Geosystems [Dealer/Distributor](#) in the country where you bought your product.

Tip of the Day

On each Start-up of LGO or Flex Office you may be presented with useful tips on special functionality.

The so-called 'Tip of the day' may also be invoked while the software is running:

- Select **Help** from the main menu and then choose **Tip of the day...**

With clicking the 'Next Tip'-button you may have a look at all the tips contained in this functionality.

GPS Tutorial

GPS Tour I: Real Time

GPS Tour I: Real Time

This Quick Tour is a step-by-step tutorial in which you learn to work with real time GPS data. With real time data the processing and applying of a coordinate system has already been done in the field. The tutorial takes you from importing the raw data via checking the field results to exporting the final local Grid coordinates.

The exercise comprises the following scenario:

A number of real time points has been measured with System 1200. The reference station was set up on point 315. A codelist has been used in the field. Point, Line and Area codes have been assigned to the survey elements.

The local coordinate system that has been used in the field is defined by:

- a UTM Zone 32 North projection
- the Bessel ellipsoid
- a Classical 3D transformation

Start this Quick Tour with [GPS Tour I - Lesson 1: Importing Real Time data](#).

GPS Tour I - Lesson 1: Importing Real Time data

In this lesson you will learn how to import GPS raw data and simultaneously create a new project.

- Start up LGO and select **Import Raw data**  either from the **Import** main menu or from the Toolbar or from the Tools **List Bar**.

The **Import Raw Data** dialog opens. In this dialog:

- Select **SmartWorx raw data** under **Files of type**.
- Browse to the directory that contains the Real Time sample data under **Look in**. By default the sample data will be installed in *C:\Documents and Settings\All Users\Documents\Lgo\Sample data\Import\GPS Real Time*
- Select the job *Sample RT 1200* and click the **Import** button.

The **Assign** dialog opens. In this dialog create a new project to import the raw data into:

- In the General tab right-click on Projects in the tree-view and select **New**.

While the **Assign** dialog stays open in the background you'll enter the **New Project** dialog.

In the **New Project** dialog:

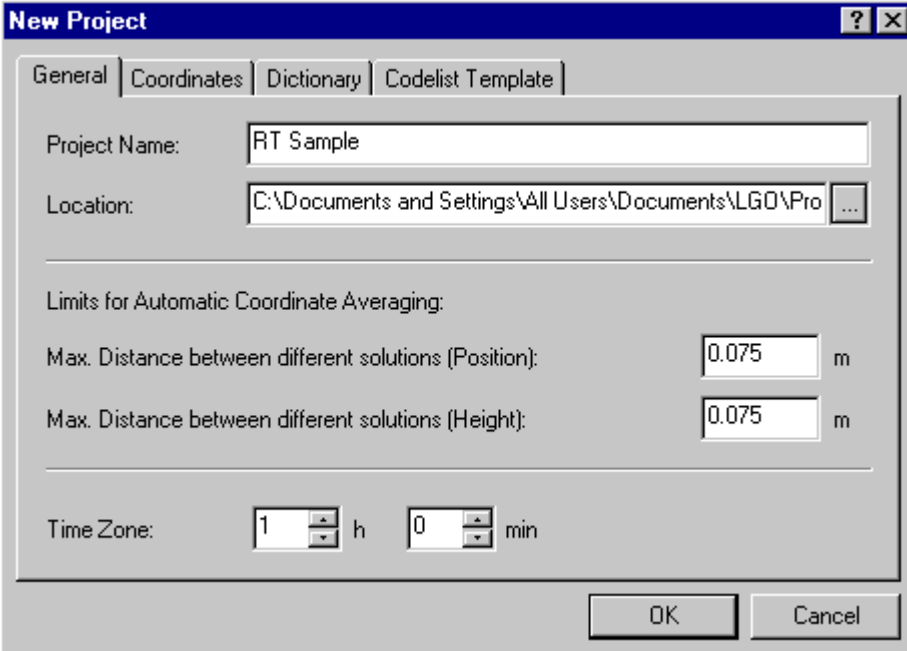

The screenshot shows the 'New Project' dialog box with the following details:

- Project Name:** RT Sample
- Location:** C:\Documents and Settings\All Users\Documents\LGO\Pro...
- Limits for Automatic Coordinate Averaging:**
 - Max. Distance between different solutions (Position): 0.075 m
 - Max. Distance between different solutions (Height): 0.075 m
- Time Zone:** 1 h, 0 min

- Under **Location** browse to where you want the Project to be stored. By default projects are stored in *C:\Documents and Settings\All Users\Documents\LGO\Projects*
- Enter the **Project Name**, e.g. *RT Sample*. A directory of the same name will be added to the path automatically. The project's files will be stored into this directory.
- Click **OK**. The new project will be created and the **New Project** dialog will be closed. You are returned to the **Assign** dialog.

In the **Assign** dialog the new project is selected automatically.

Click the **Settings** tab and select:

- To **Import the coordinate system & components** that have been used in the field to LGO's Coordinate System Management.

- To **automatically attach** the coordinate system to the selected project.

Click the  **Fieldbook** button to create a [Fieldbook Report](#).

Click the **General** tab to return to the General page of the Assign dialog:

- Click **Assign** and then **Close**. The raw data will be assigned to the new project and the **Project window** opens automatically.

Continue with [GPS Tour I - Lesson 2: View and Edit the Real Time data](#).

For more information **see also**:

[How to Import GPS Raw Data](#)

[Create a new Project](#)

GPS Tour I - Lesson 2: View and Edit the Real Time data

In this lesson you will learn how to explore the Real Time data in the **View/ Edit** component of LGO. You can check the quality of your coordinates as well as the thematical code information before you proceed with exporting the data.

- Click the **View/ Edit** tab to open the **View/ Edit** project window.



The view opens in local grid and is zoomed to full extents including the reference station.

- Use the  toolbar button to zoom into the detail points.
- By default the GPS baseline vectors (the red lines) are switched on. To change this setting:
- Right-click in the background and select **Graphical Settings**

In the **View** tab:

- Under **General** select Grid.
- Under **Data** deselect *GPS Observations*.

Now you have a clearer view on how the survey was performed.

The sample Real Time data contains two different point classes (*measured*  as well as *averaged* ; since in the Real Time mode the points are processed in the field already you will not find any of the lower point classes, like e.g. *Navigated*). Point codes as well as Line and Area codes have been assigned to the survey elements.

Let us first have a look at the quality of the *averaged Point 001*:

- Right-click on **Point 001** and select **Properties**.
- Click the **Mean** tab to view the two solutions for Point 001 and their differences to the weighted average.
- Click **OK** or **Cancel** to exit the property sheet.

The mean coordinates of averaged points in the project are summarized and can also be viewed in the **Mean Coordinates & Differences Report**.

- From the **Tools** main menu select **Mean Coordinates & Differences** to open the report.

Now, let us check the thematical code information of two different **Area objects**.

- From the **Select point** combo box select Point 184, center the view to this point via the  **Scroll to selected point** toolbar button and **zoom in** using the "+"-key on the keyboard till you see the [following extents](#):

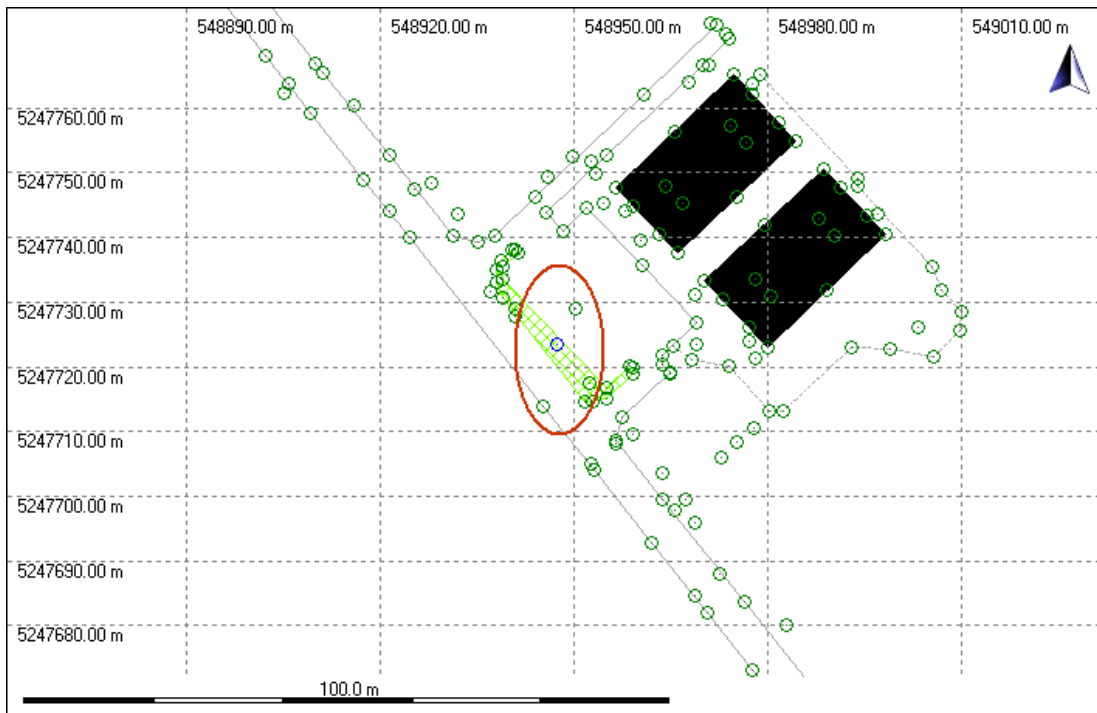

- To view the properties of the circled **Area**, right-click onto one of its borders and select **Properties...** from the context menu.

The [Line/ Area Properties](#) dialog opens.

Line/Area Properties [?] [X]

General | Thematical Data

Area Id:

Code:

Border Style:

Border Color:

Border Width:

Shading Style:

Shading Color:

Length of Perimeter:

Area Enclosed:

OK Cancel Apply

- In the **General** tab view the **Border** and **Shading** styles of the Area, its **Code**, **Length of Perimeter** and the **Area Enclosed**.

To be able to modify the border or shading styles of this area you can either set the **Code** to [none] in the **General** tab: the **Border** and **Shading Style** combo boxes become editable. Or you can modify the definition of the code in the [project specific codelist](#).

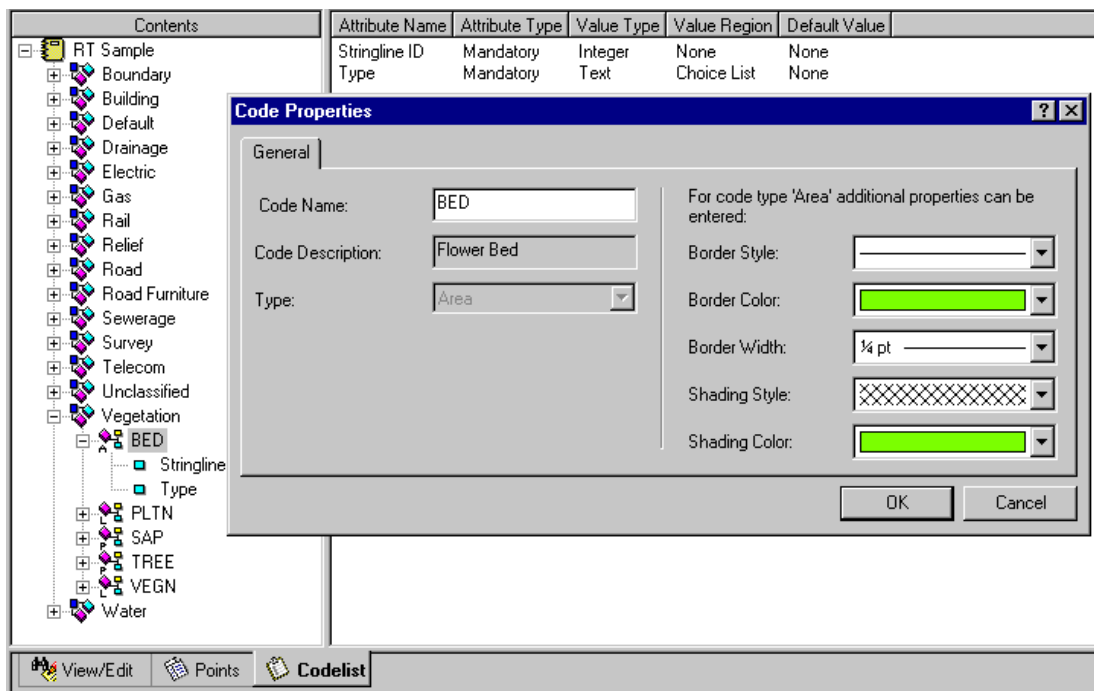

- In the **Thematical Data** tab view the **Code** details as defined in the project specific codelist.
- Leave the dialog with **OK** or **Cancel**.

Now, let us change the appearance of one of the black squares:

- Right-click on the border of one of the black squares and select **Properties...** from the context menu.

In contrast to the flower bed this area has been measured **without** a code in the field. Therefore, you can directly edit the Line/ Area properties.

- In the **General** tab of the **Line/ Area Properties** dialog see that the **Code** for this area is [none]. [Change](#) the **Border Color** and the **Shading Color** and select a different **Shading Style**.

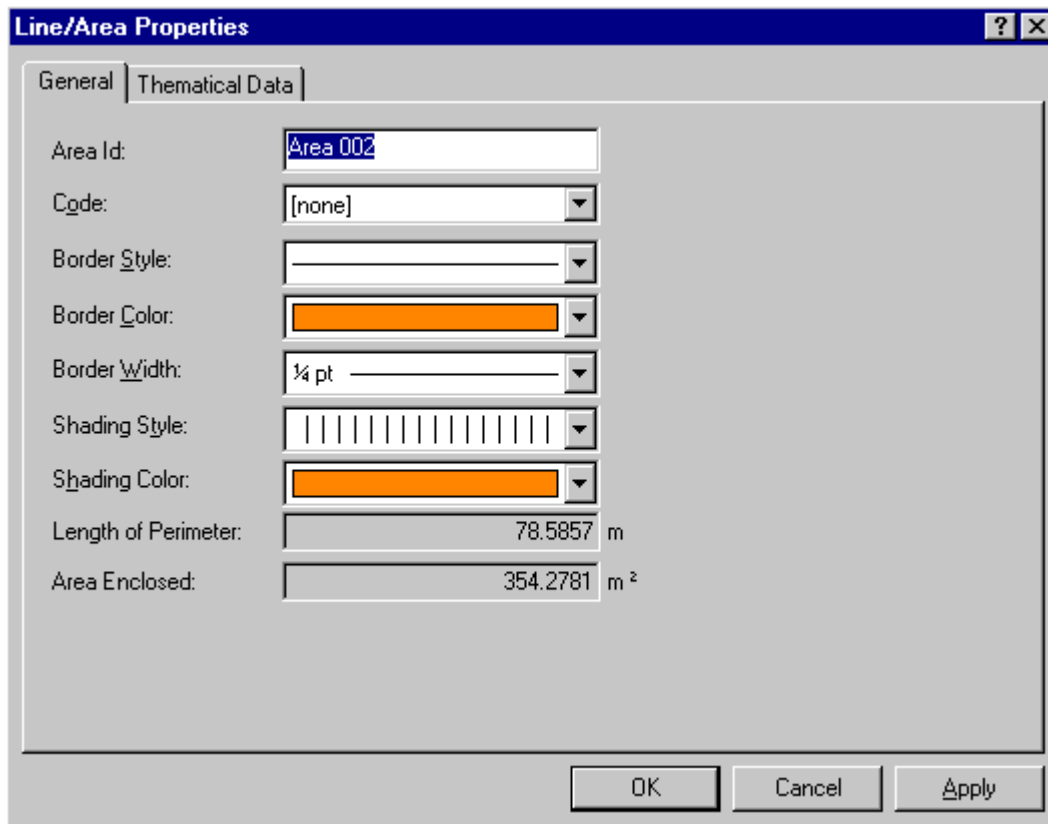

The [result](#) looks like this:

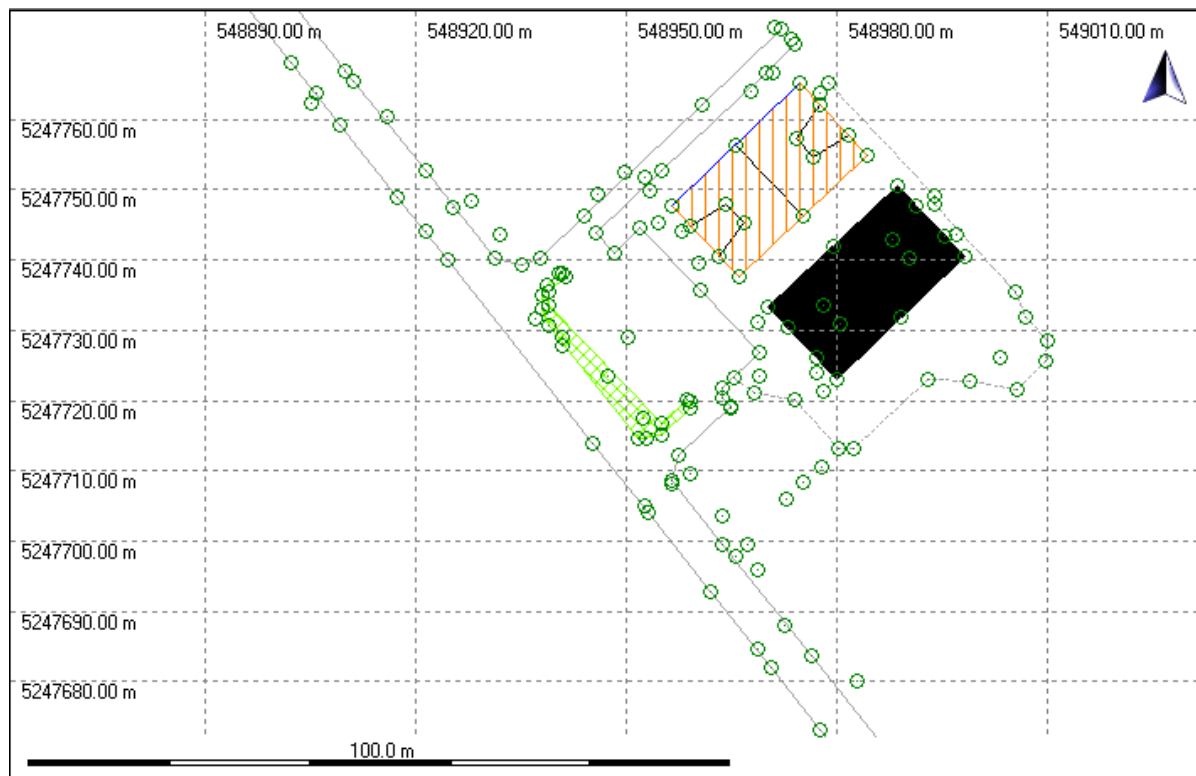

Continue with [GPS Tour I - Lesson 3: Exporting coordinates to a Custom ASCII file.](#)

GPS Tour I - Lesson 3: Exporting coordinates to a Custom ASCII file

In this lesson you will learn how to export coordinates to a customized ASCII file. The **Custom ASCII File** export is using a pre-defined format template file (*.frt) to export the data. Format template files can be created using the *Leica Geosystems Format Manager* program.

To complete this exercise a sample format template file (sample.frt) is installed automatically on your computer with LGO. If you wish to create your own format template file, please, refer to the **Online Tutorial** of the Format Manager Online Help.

- While the project is still open select **Export ASCII Data**  from the **Export** main menu or from the **Toolbar** or from the **Tools List Bar**.

In the **Export ASCII data** dialog:

- Under **Save as type** select **Custom ASCII file (*.cst)**
- Enter a **File name**, e.g. *RT Sample1* without extension.
- Click on the **Settings** button to change the settings and select the format template file.

In the **General** page of the **Custom ASCII Export Settings** dialog:

- Change the **Coordinate Class** to **Main**. The coordinate triplets of the highest class will be exported.
- Use the browser  to select the file **Sample.frt**. By default the file will be installed in *C:\Documents and Settings\All Users\Documents\Lgo\Sample data\Format files*

In the **Coordinate System** page of the **Custom ASCII Export Settings** dialog:

- Make sure the coordinate system **Sample RT 1200** is selected.
- Click **OK** to close the **Settings** property page. Back in the **Export ASCII data** dialog click **Save** to write the ASCII file to the hard disk.

Open the ASCII file in a text editor to watch the [results](#).

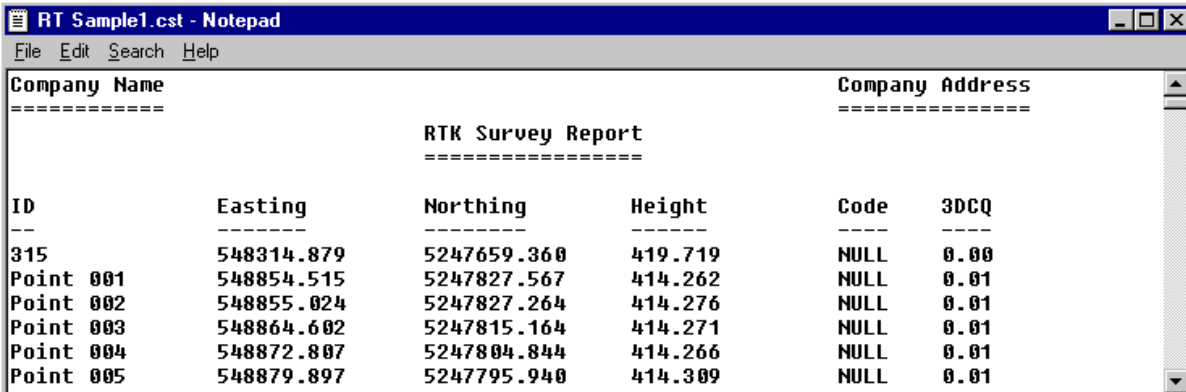

ID	Easting	Northing	Height	Code	3DCQ
315	548314.879	5247659.360	419.719	NULL	0.00
Point 001	548854.515	5247827.567	414.262	NULL	0.01
Point 002	548855.024	5247827.264	414.276	NULL	0.01
Point 003	548864.602	5247815.164	414.271	NULL	0.01
Point 004	548872.807	5247804.844	414.266	NULL	0.01
Point 005	548879.897	5247795.940	414.309	NULL	0.01

Congratulations! You have successfully completed this Quick Tour through LGO.

Note:

- [Quick Tour III](#) explains how to export the project to a DXF format.

To **learn more about** the other pre-defined Export formats **refer to**:

[ASCII Export](#)

[GIS / CAD Export](#)

GPS Tour II: Post-Processing

GPS Tour II: Post-Processing

This Quick Tour is a step-by-step tutorial in which you learn to post-process GPS data. The tutorial takes you from importing the raw data to exporting the final local Grid coordinates.

To complete this exercise the two options **GPS-Processing** and **Datum and Map** have to be included in your [licence](#).

The exercise comprises the following scenario:

A rapid static network has been measured. It consists of the points 309, 311, 315, 401 and 402. The local coordinates of the points 315, 402 and 309 are known. The data shall be processed and the local coordinates of the points 311 and 401 shall be derived.

Start this Quick Tour with [GPS Tour II - Lesson 1: Importing Raw Data](#).

GPS Tour II - Lesson 1: Importing Raw Data

In this lesson you will learn how to import GPS raw data and simultaneously create a new project.

- Start up LGO and select **Import Raw data**  either from the **Import** main menu or from the Toolbar or from the Tools **List Bar**.

The **Import Raw Data** dialog opens. In this dialog:

- Select **SmartWorx raw data** under **Files of type**.
- Browse to the directory that contains the sample data under **Look in**. By default the sample data will be installed in *C:\Documents and Settings\All Users\Documents\LGO\Sample data\Import\GPS Static*.
- Check **Include subfolders**. All System1200 raw data contained in the two sub-directories *Data_1* and *Data_2* will be imported in one run.
- Click the **Import** button.

The **Assign** dialog opens. In this dialog create a new project to import the raw data into:

- In the **General** tab right-click on **Projects** in the tree-view and select **New...** from the context menu.

While the **Assign** dialog stays open in the background you'll enter the **New Project** dialog.

In the **New Project** dialog:

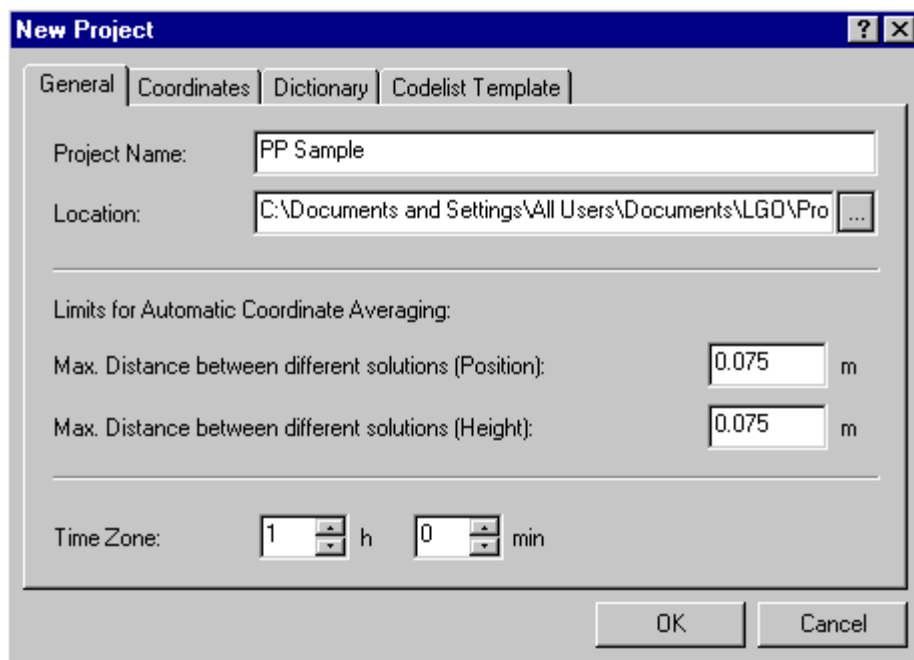

- Under **Location** browse to where you want the Project to be stored. By default projects are stored in *C:\Documents and Settings\All Users\Documents\LGO\Projects*.
- Enter the **Project Name**, e.g. *PP Sample*. A directory of the same name will be added to the path automatically. The project's files will be stored into this directory.
- Click **OK**. The new project will be created and the **New Project** dialog will be closed. You are returned to the **Assign** dialog.

In the **Assign** dialog the new project is selected automatically.

- Click **Assign** and then **Close**. The raw data will be assigned to the new project and the **Project window** opens automatically.

Continue with [GPS Tour II - Lesson 2: Processing Baselines](#).

For more information **see also**:

[How to Import GPS Raw Data](#)

[Create a new Project](#)

GPS Tour II - Lesson 2: Processing Baselines

In this lesson you will learn how to process and store baselines.

In the Project window you may switch between different **Views** to display the project's content.



In **View/ Edit** you see the graphical representation of each point. Directly after import of the Raw data their highest class is *Navigated* .

Now, switch to the **GPS-Processing** view and select the baselines to be processed.

Please, note that LGO offers two processing modes: **Manual** and **Automatic**. In this exercise let us proceed with processing the network manually step by step.

Click the **GPS-Proc**  tab at the bottom of the project window. The GPS-Processing view graphically displays a list of all observation intervals.





- Click on  **Select Mode: Reference** from the toolbar. The cursor indicates Reference.
- Click on the horizontal bar of point 402 to select it as the Reference.
- Click on  **Select Mode: Rover** from the toolbar. The cursor indicates Rover.
- Click on the horizontal bars of the first instant of point 315, 401 and 309 to select these observation intervals as Rover.
- Click on  **Process** from the toolbar.

Illustration:



When the processing run is complete the display automatically switches to the **Results**  view allowing you to examine and store the processed baselines. The rover points of all baselines for which ambiguities have been resolved are automatically selected.

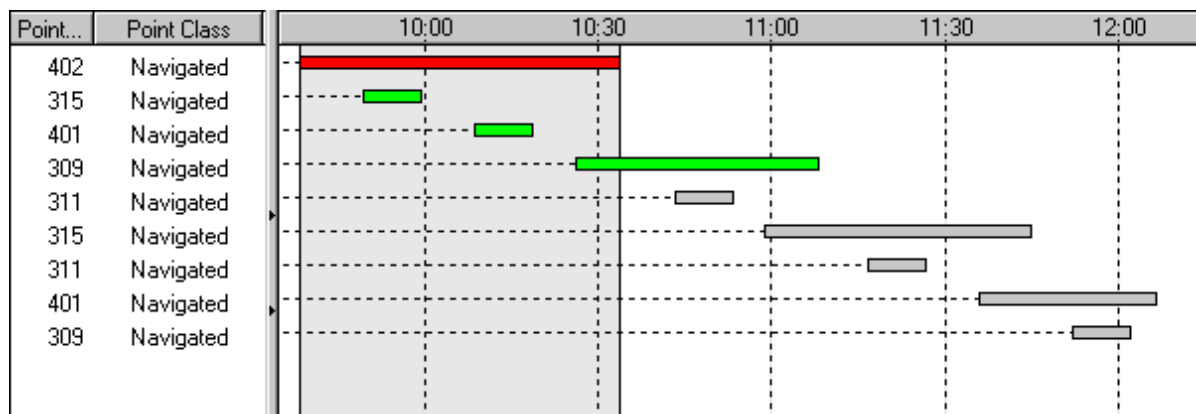

- To store the selected baselines press  **Store** from the toolbar or right-click into the view and select **Store** from the context menu. You can graphically view the stored baselines in the **View/Edit** tab.

To complete the network you have to complete three more processing runs:

- Return to the GPS-Processing view, right-click in the background and select **Deselect All** from the context menu. To select, process and store the remaining baselines proceed like you did in the first run: for the second processing run select 309 as Reference and 311 and 315 as Rover, for the third run select 315 as Reference and 311 and 401 as Rover, for the fourth run select 401 as Reference and 309 as Rover.

To process the network in the **automatic** mode proceed as follows:

- Directly after import select **Processing Mode Automatic** from the **GPS-Proc** main menu. The cursor indicates 'automatic'. Select all baselines and process. For details see: [Processing Modes \(GPS\)](#)

You can now view the entire network by clicking back to the **View/Edit** tab. The Point Classes have now changed to *Reference*  or *Averaged* . For points where more than one measurement exists a weighted average is automatically computed. To inspect how the solutions fit right-click on such a point, select **Properties** and click the **Mean** tab in the [Point Properties](#) dialog.

To check your results, you can also calculate [GPS Loop Misclosures](#).

You have now finished the GPS Processing. Continue with [GPS Tour II - Lesson 3: Importing an ASCII File](#).

For more information **see also**:

[View/Edit](#)

[Point \(Coordinate\) Classes and Subclasses](#)

[GPS Processing View](#)

[Select an observation interval for computation](#)

[Processing GPS data](#)

[Results View](#)

[Store the GPS-Processing Results](#)

GPS Tour II - Lesson 3: Importing an ASCII File

In this lesson you will learn how to import the local control points from a user defined ASCII file into a Project.

- Select **Import ASCII data**  either from the **Import** main menu or from the Toolbar or from the Tools List Bar.

The **Import ASCII Data** dialog opens. In this dialog:

- Select **Text files** under **Files of type**.
- Browse to the directory that contains the sample ASCII data under **Look in**. By default the sample data will be installed in *C:\Documents and Settings\All Users\Documents\LGO\Sample data\Import\GPS Static*
- Select the file *Local.txt*.
- Under **Coordinate System** select **Local** and under **Height Mode** select **Orthometric**.
- Click the **Import** button.

The **Import Wizard** allows you to define the file format. In this exercise the file to be imported is a simple ASCII file with local coordinates of three points separated by spaces.

- In Step 1/4 select **Free** format and **Next** to continue.
- In Step 2/4 select **Space** as the column separator and **Next** to continue.
- In Step 3/4 make sure the **Coordinate Type** is set to *Grid*. Then right-click on the first column and select **Point Id**. In the same way assign **Coordinates Easting**, **Coordinates Northing** and **Orth. Height** to the following columns. Press **Next**.
- In Step 4/4 you can save the import mask as a template for the next time you import an ASCII file. Press **Finish** to proceed to the Assign dialog.

In the **Assign** dialog **create a new project** to import the ASCII data into:

- In the General tab right-click on **Projects** in the tree-view and select **New**.
- Enter the **Project Name** (e.g. *PP Sample Local*) and click OK to confirm.
- Click **Assign** and then **Close**. The project opens automatically and displays the local coordinates for the points 315, 309 and 402.

The local control points are now stored in the project. You can close the project and continue with [GPS Tour II - Lesson 4: Calculating Transformation Parameters](#).

For more information **see also**:

[Text File Import](#)





[User Defined ASCII File Import Wizard](#)

[Create a new Project](#)

GPS Tour II - Lesson 4: Calculating Transformation Parameters

In this lesson you will learn how to use the Datum/Map tool to calculate the transformation parameters. A simple **Onestep** transformation shall be computed to transform the WGS84 coordinates of the Project *PP Sample* to the local coordinates as given in the Project *PP Sample Local*.

- Start up the **Datum/Map** tool  either from the **Tools** main menu or from the Tools **List Bar**.
- In the upper part of the **Selection view** select the Project *PP Sample*.
- In the lower part of the Selection view select the Project *PP Sample local*.
- Click on the Match tab to continue.
- In the **Match view** right-click in the background and select **Configuration**. Under **Transformation type** select **Onestep**. Set the **Height mode** to *Orthometric* and confirm with OK.
- Right-click in the background and select **Auto Match** to automatically match the common points according to identical Point IDs. Three points will automatically be matched for the calculation.
- Click the **Results** tab to view the residuals of the transformation. You may additionally display a **Chart** or a **Report** by clicking on the appropriate tabs.
- To store the transformation parameters right-click in the background of the Results view and select **Store** from the context menu. In the following dialog enter a **name** for the new transformation parameter set. Additionally, check the two boxes in the dialog to automatically create a new coordinate system using the new transformation and to automatically attach this coordinate system to the project *PP Sample*.

In your project *PP Sample* you can now display coordinates in either **WGS84** or **Local** coordinates. Open the project again (or switch to the project window if it is still open), click on the **Points**  tab and switch between WGS84  Geodetic  and Local  Grid  using the Coordinate Format toolbar buttons.

Continue with [GPS Tour II - Lesson 5: Exporting coordinates to a user defined ASCII file](#).

For more information **see also**:

[Datum/Map](#)

[Selection View](#)

[Match View](#)

[Results \(Datum/ Map\)](#)

[Store Transformation Parameters](#)

GPS Tour II - Lesson 5: Exporting coordinates to a user-defined ASCII file

In this lesson you will learn how to export coordinates to a user defined ASCII file.

- While the project is still open select Export ASCII data  either from the **Export** main menu or from the **Toolbar** or from the **Tools List Bar**.

The **Save File As** dialog opens. In this dialog:

- Under **Save as type** select Text file (*.txt).
- Enter a file name.
- Click on the **Settings** button to change the export settings.

The [User-defined Export Settings](#) dialog opens.

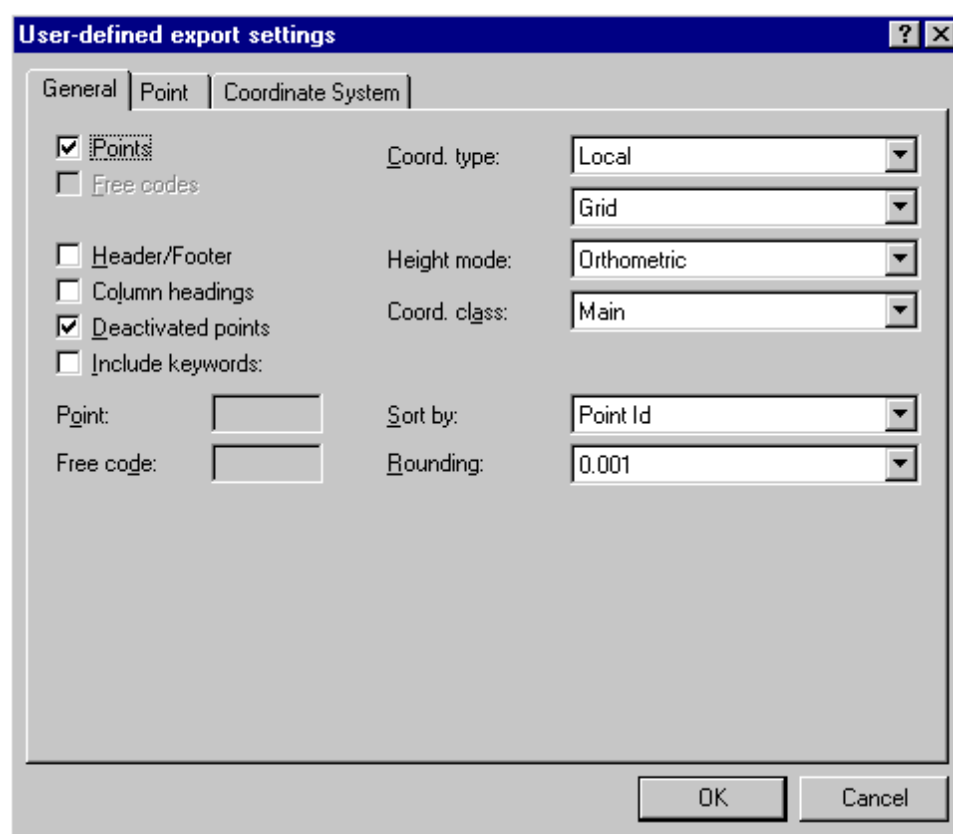

- In the General page change the **Coord Type** to **Local** and **Grid**. Set the **Height mode** to **Orthometric**.
- Change the **Coord Class** to **Main**. The coordinates of the highest point class will be exported.
- Click on the [Point tab](#) to select the items to be exported in the order you want. Double-click on *Point Id*, then *Easting*, then *Northing*, then *Orth. height*.

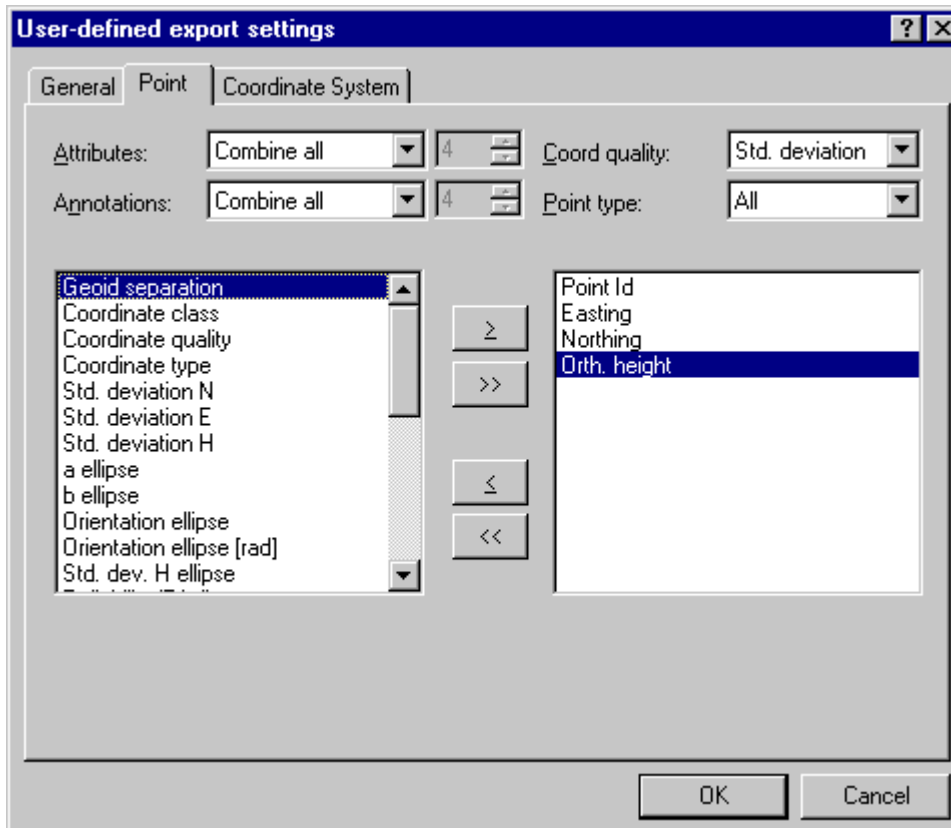

- Click on **OK** to close the Settings property page and finally **Export** to write the file. You can now examine the ASCII file that you just created with a text editor.

Congratulations! You have successfully completed this Quick Tour through LGO.

For more information **see also**:

[User defined ASCII File Export](#)

[User-defined Export Settings](#)

To **learn more about** the other pre-defined Export formats **refer to**:

[ASCII Export](#)

[GIS / CAD Export](#)

GPS Tour III: GIS/ CAD Export

GPS Tour III: GIS/ CAD Export

This Quick Tour is a step-by-step tutorial in which you learn how to export data from LGO to a GIS or CAD System using the DXF format.

To complete this exercise the option **GIS/ CAD Export** has to be included in your [licence](#).

The GIS/CAD Export requires a DXF-header file. A DXF-header file can be created in your CAD package and contains all block and attribute definitions, layer definitions, line styles, drawing extents and other settings needed by your GIS/CAD program in order to convert the DXF file into a drawing file. The DXF header file should be based on your GIS/CAD template file such that it contains all definitions that you work with. For information on how to create a DXF-header file please refer to the documentation of your GIS/CAD software package.

To complete this exercise a DXF-header sample file is already copied to your harddisk with the installation of LGO.



Before you start with this Quick Tour make sure that you have already imported the Real Time sample data into LGO as explained in [GPS Tour I - Real Time](#). Since for GIS/ CAD Export the point coordinates in your project must be convertible to local grid coordinates, a coordinate system must be attached to the project.

Start this Quick Tour with [GPS Tour III - Lesson 1: Creating a Lookup Table](#).

GPS Tour III - Lesson 1: Creating a Lookup Table

In this lesson you will learn how to create a Lookup Table.

In the Lookup table you define how to convert the surveyed data to the corresponding symbols in the CAD package. The thematical codes used in the field have to be matched with the blocks defined in the DXF-header file. A block can contain the graphical symbol and attributes which define the point. Lines and Areas used in the field must also be matched with a line style, color and width as defined in the DXF-header file. Every thematical code, for points, lines and areas, used on the field system can be matched with the required symbol in your GIS/ CAD package.

- Open the Project RT Sample and click the  **Points** tab to display the **Points** View.
- Display the local grid coordinates via the **Coordinate Format** toolbar: 
- Select **Export GIS/CAD data**  either from the **Export** main menu or from the Toolbar or from the Tools **List Bar**.

The **Export GIS/CAD data** dialog opens. In this dialog:

- Under **Save as type** select **AutoCAD Files (*.dxf; *.dwg)**.
- In the **Lookup Table** box right-click and select **New** to create a new Lookup Table. Once a Lookup Table is created it is available for future use.

The **Codelist-Lookup-Table Settings** dialog opens. In this dialog:

- In the **General tab** enter a **Lookup Table Name**, e.g. *Sample DXF*.

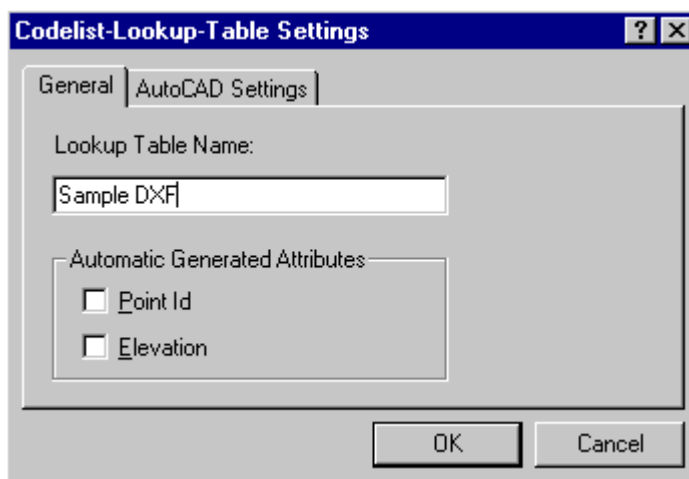

- In the **AutoCAD Settings** page select the **DXF-header file** for use in the GIS/ CAD Export. Use the browser  to select the file **Sample_Header.dxf**. By default the sample template will be installed in *C:\Documents and Settings\All Users\Documents\LGO\Sample data\Export GISCAD*.
- Click **OK** to confirm the settings of the new Lookup Table.

Back in the **Export File** dialog you see that the **Lookup** button is active now.

- To continue click the **Lookup** button.

The **Codelist-Lookup-Table Definition** dialog opens:

- In the left hand pane the codelist used in the field is represented in an expandable tree-view.
- The right hand pane is divided in two parts.

In the upper part the two Coding types to be matched, i.e. **Leica Coding** and **AutoCAD Coding** are positioned right next to each other. The Leica Code to be matched is selected from the left hand tree-view and cannot be edited. The corresponding AutoCAD block, line or area, as defined in the DXF-header file is selected in the right-hand side.

It is possible to match Leica Line and Area codes with AutoCAD line styles, widths and colors.

It is possible to match Leica point codes with AutoCAD blocks. In the lower part of the dialog Leica Code and AutoCAD Block **Attributes** can be matched.

Please, note that if the Leica Coding and the AutoCAD Coding use **identical** names, then Code Groups, Codes and Attributes are **automatically** matched, like it is the case in this example. To learn how to **manually** match Leica Code Groups and Codes to AutoCAD Layers and Blocks look at the working example below. If attributes do not use identical names, they have to be matched manually in the lower part of the dialog, too.

[Working Example \(Points\):](#)

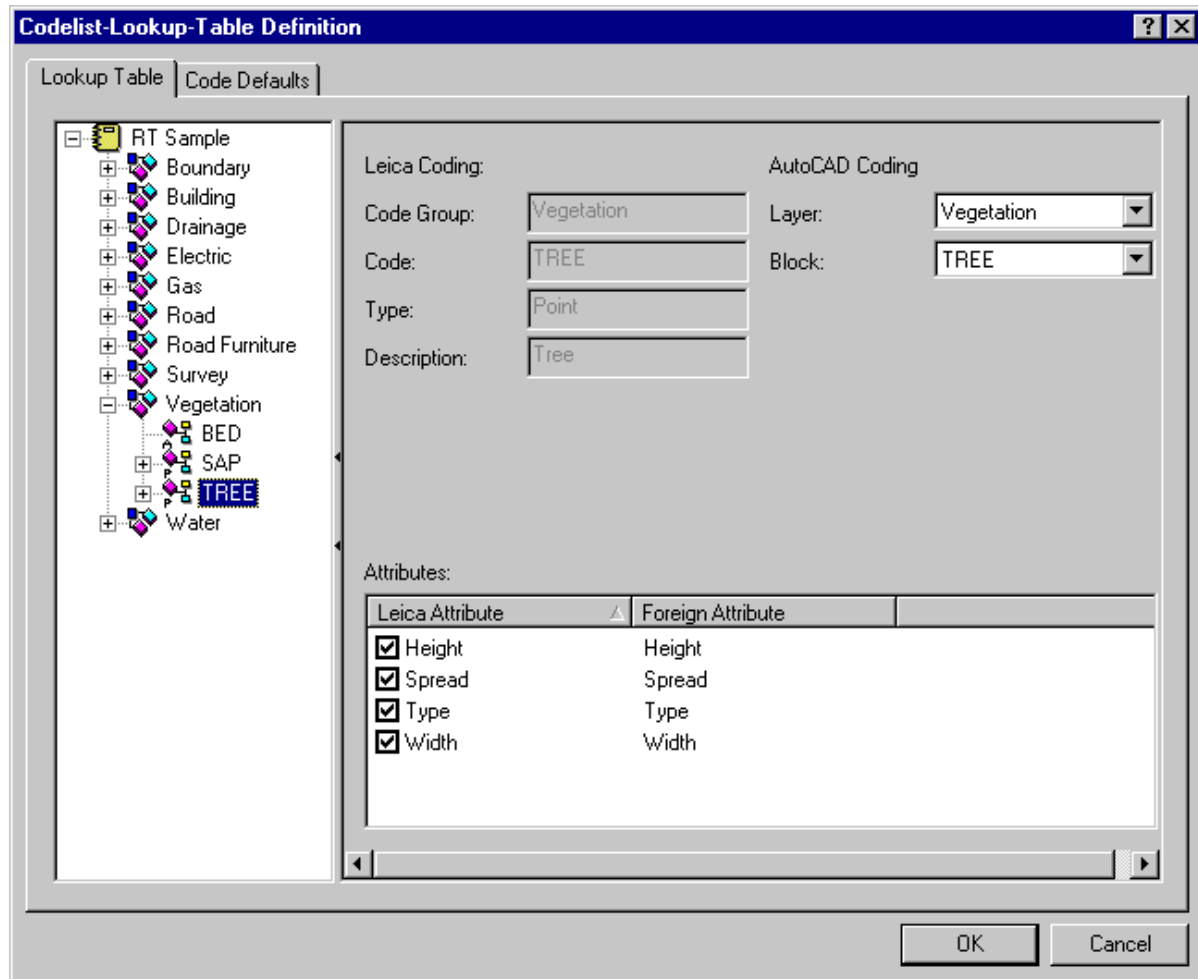

To manually create the Lookup Table for the Point Codes you would have to proceed as follows. Have a look at the **Working Example** first:

- In the tree-view on the left expand all Code Groups.
- In the expanded tree-view select the Code **TREE** from the Code Group **Vegetation**. See that in the **Leica Coding** field on the right the corresponding coding information is displayed for read-only.
- In the **AutoCAD Coding** field match the Leica **Code Group** and **Code** with the AutoCAD **Layer** and **Block**: select **Vegetation** and **TREE** from the combo boxes.

Now, you have managed to successfully match the *Leica Code TREE* with the *AutoCAD Block TREE*.

- In the same way you can continue to match the remaining *Leica Point Codes* with the corresponding AutoCAD blocks.

[Working Example \(Lines\):](#)

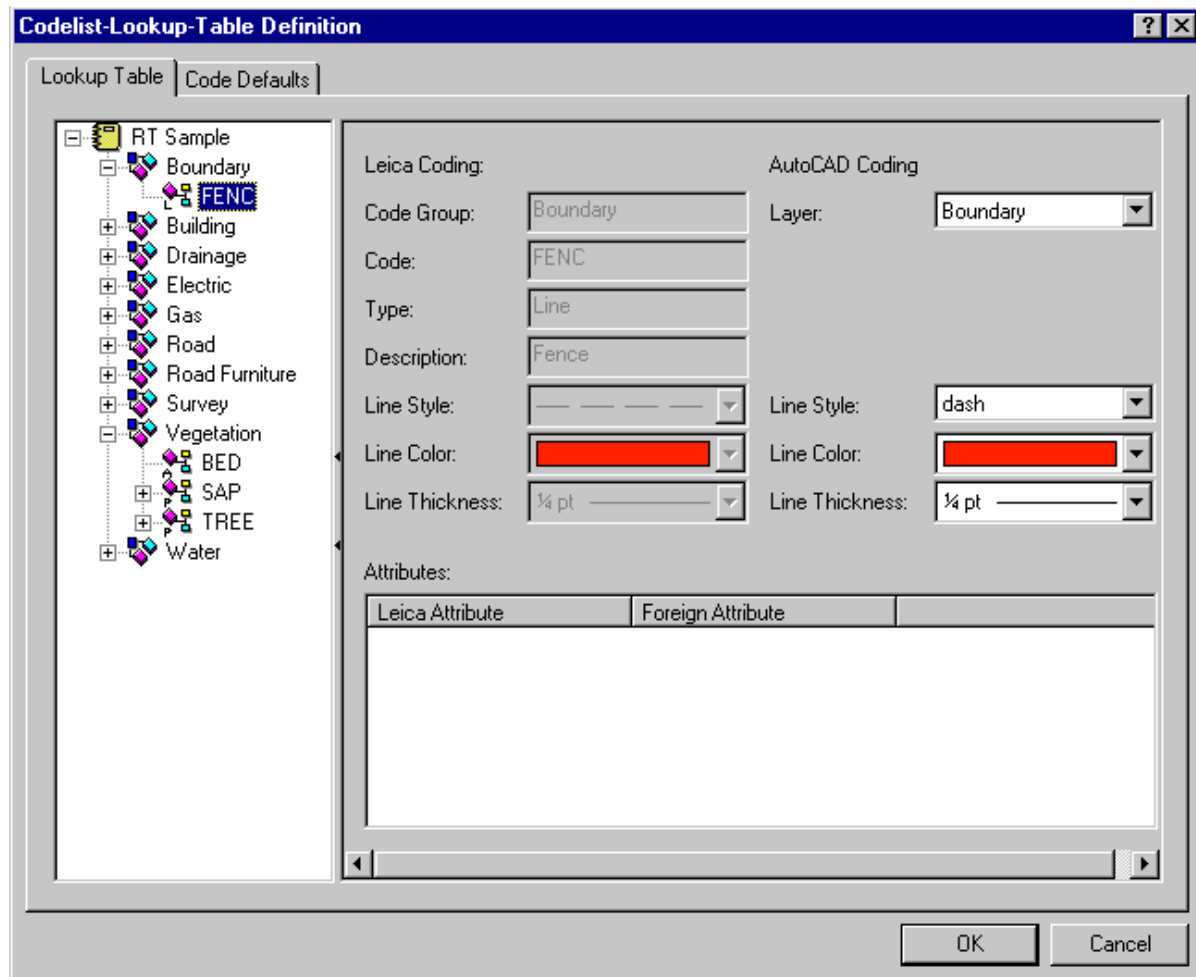

To continue creating the Lookup Table for the Line Codes have a look at the **Working Example** and proceed as follows:

- In the expanded tree-view select the Code **FENC** from the Code Group **Boundary**. See that in the **Leica Coding** field on the right the corresponding coding information is displayed for read-only.
- To match Leica Line and Area codes with the corresponding AutoCAD line and area styles select the AutoCAD line style, width and color.
- Continue to match the remaining *Leica Line and Area Codes* with the corresponding AutoCAD blocks. When **all** Codes are matched click **OK** to confirm.

Now, you have successfully defined the Lookup Table **Sample DXF**. To learn how to finally export the DXF file continue with [GPS Tour III - Lesson 2: Exporting the DXF file](#).

GPS Tour III - Lesson 2: Exporting the DXF file

In this lesson you will learn how to create a GIS/ CAD file in DXF-format based on the Lookup Table that you have defined in the previous lesson.

Back in the [Export File](#) dialog proceed as follows:

- Click the **Settings** button.

The **Export Settings** dialog opens.

In the **General tab** of this dialog:

- Change the **Coord Class** to **Main** to always export the coordinate triplets of the highest class.
- Make sure **Coord Type** is set to **Local** and **Grid** and the **Height mode** is set to **Orthometric**.

In the **Coordinate System** tab:

- Make sure the Coordinate System *Sample RT 1200* is selected.

In the **AutoCAD** tab:

- Make sure that the **Format** is set to **DXF**. DXF is the ASCII format which is supported by most GIS/ CAD packages.
- Leave the **Export Settings** dialog with **OK**.

Back in the **Export file** dialog:

- Under **Save in** browse to the directory where you want the AutoCAD file to be stored.
- Enter a **File name**, e.g. *Sample*. The extension *.DXF will be added automatically.
- Finally, click **Save** to export the file.

A GIS/ CAD file in DXF format will be created.

Congratulations! You have successfully completed this Quick Tour through LGO.

You can now import the file into your GIS/ CAD package. In AutoCAD it should then look [as follows](#):

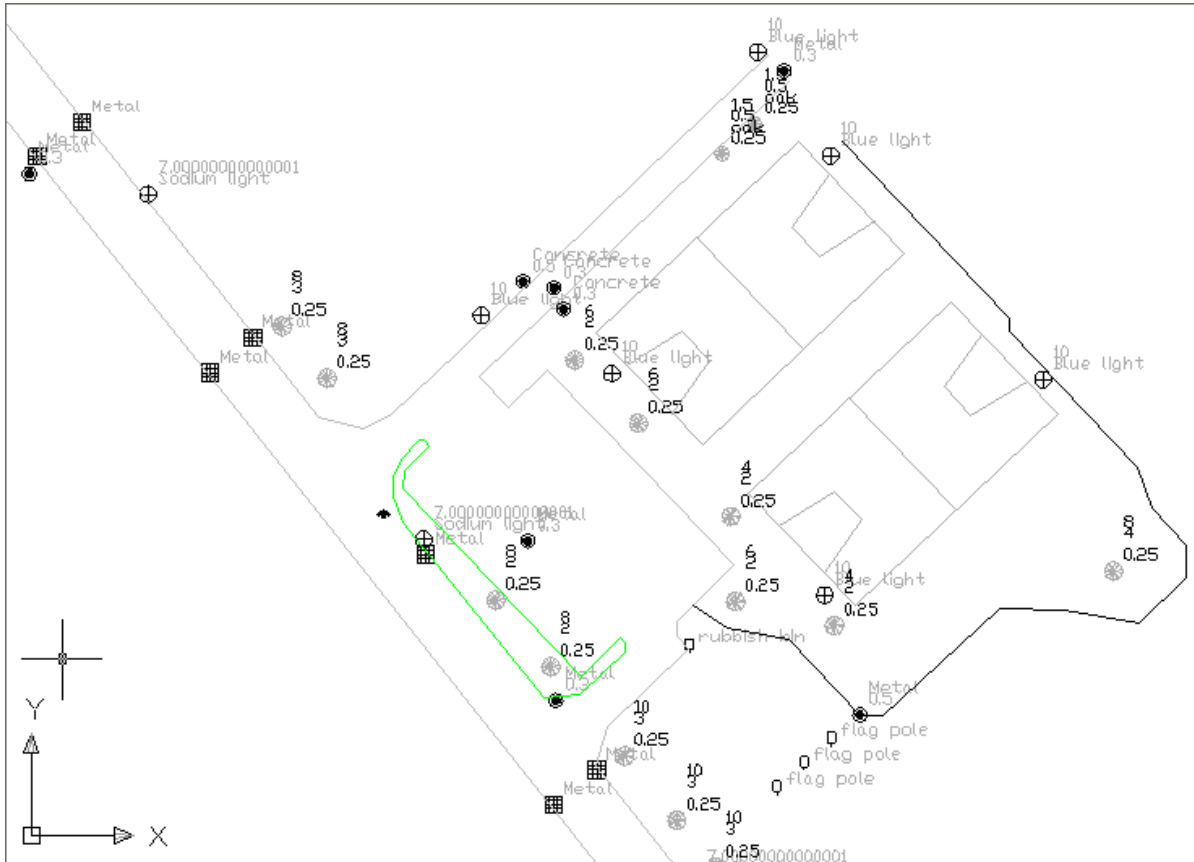

TPS Tutorial

TPS Tour I: Referencing a background image

TPS Tour I: Referencing a background image

This Quick Tour is a step-by-step tutorial in which you learn how to reference a background image within the **Map Referencing** component of LGO.

You will learn how to first register a given image, how to identify and match the common points and how to finally reference the image to the local coordinates.

The referenced image will be used as a background image in the following Quick Tours. You will see how it can be very useful to be able to identify given and newly measured points in a background image. The TPS data you will work on in the following Quick Tours is mostly only preliminary data which still has to be oriented before it fits. You will see that once all data has been updated the measured points fit into the background image perfectly.

Start this Quick Tour with: [TPS Tour I - Lesson 1: Registering the background image and identifying the common points](#).

TPS Tour I - Lesson 1: Registering the background image and identifying the common points

The objectives of this lesson are:

- To register the given sample image **Leica Areal-map**.
- To identify the common points within the image

Now, start with opening the **Map Referencing** component in LGO and registering the sample background image.

- Select  **Image Referencing** either from the **Tools** main menu or from the **Management List Bar**.
- Right-click either into the tree-view or into the report view and select **Register...** from the background menu.

The **Register image** dialog opens. In this dialog:

- Under **Look in** browse to the directory where the sample image is stored. By default the sample image for this lesson will be installed in *C:\Documents and Settings\All Users\Documents\LGO\Sample data\Image*. **.
- Select *Leica Areal-map.jpg* to be registered.
- Click the **Register** button to register the image in the Map Referencing component.

Back in the **Image Referencing** component:

- Click on the image in the tree-view to open it in the right-hand side view.

To be able to easily **identify the common points** see the [following](#) representation of the background image in which the location of the common points is marked with red circles.

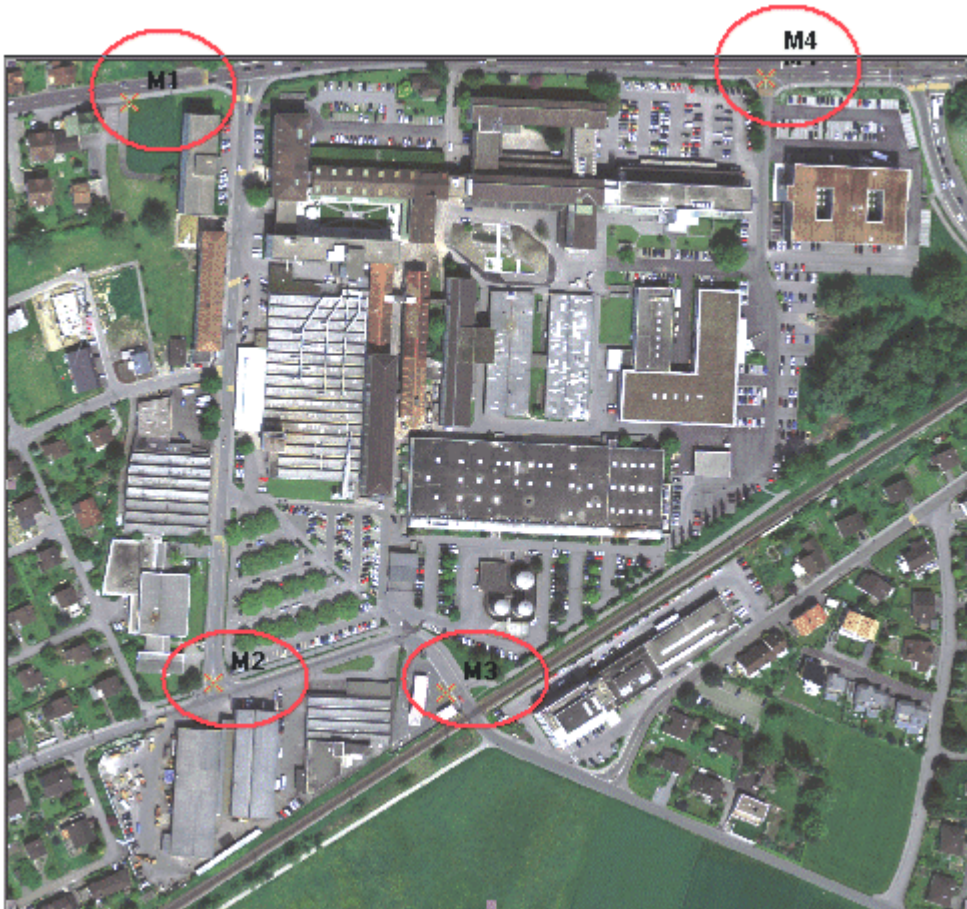

Now, you have to **zoom in** to the area of each of these red circles to better identify the precise location and determine the **image coordinates** of the common points.

- Right-click into the image and select **Zoom In** from the context menu.
- Zoom in to the area of the first common point **M1** until you see roughly the [following](#) extents:



- Locate M1 in the image as shown above: Double-click onto the indicated point to position M1. A little cross  indicates the location of a common point.

See that the point has been added with its **image coordinates** to the report view underneath the image as **Point 1**.

- Zoom back to full extents (**Zoom 100%**) to locate the second common point **M2**.
- Right-click into the image and select **Zoom In** from the context menu.
- Zoom in to the area of the second common point **M2** until you see roughly the [following](#) extents:



- Locate M2 in the image as shown above: Double-click onto the indicated point to position M2.
See that the point has been added with its **image coordinates** to the report view underneath the image as **Point 2**.
- Now zoom in to the area of the third common point **M3** until you see roughly the [following](#) extents:



- Locate M3 in the image as shown above: Double-click onto the indicated point to position M3.
See that the point has been added with its **image coordinates** to the report view underneath the image as **Point 3**.
- Now zoom in to the area of the fourth common point **M4** until you see roughly the [following](#) extents:

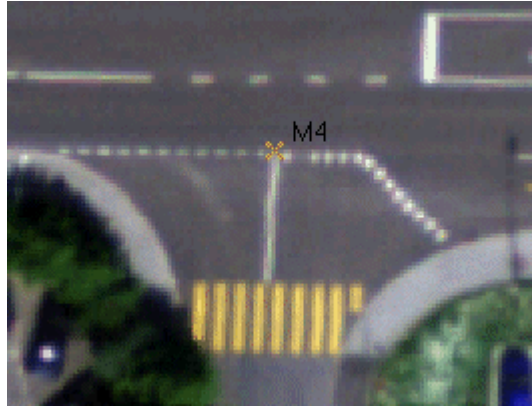

- Locate M4 in the image as shown above: Double-click onto the indicated point to position M4.

See that the point has been added with its **image coordinates** to the report view underneath the image as **Point 4**.

Now, you have identified all common points with their image coordinates in the sample background image *Leica Areal-map*. You have to proceed now with importing the local grid coordinates of the common points into LGO.

Continue with [TPS Tour I - Lesson 2: Matching common points and referencing the image](#).

TPS Tour I - Lesson 2: Matching common points and referencing the image

The objectives of this lesson are:

- To import the local grid coordinates of the common points from a GPS RTK job into an LGO project.
- To "copy & paste" the local grid coordinates of the common points into the **Image Referencing** component.
- To reference the background image.

The local grid coordinates have been measured in a GPS RTK job called **MAP**. The data shall be imported into a separate LGO project called *MAP*.

- Select  **Import Raw data** either from the **Import** main menu or from the Toolbar or from the Tools [List Bar](#).

The [Import Raw Data](#) dialog opens. In this dialog:

- Select **SmartWorx raw data** under **Files of type**.
- Browse to the directory that contains the sample data under **Look in**. By default the sample data for this lesson will be installed in *C:\Documents and Settings\All Users\Documents\LGO\Sample data\Import\TPSMap*. **
- Select the job *MAP* to be imported.
- Click the **Import** button.

The **Assign** dialog opens. In this dialog:

- In the **Settings** tab ensure that the **Import coord system & components** flag is ticked.
- In the **General** tab right-click on **Projects** in the tree-view and select **New...** from the context menu to create a new project to import the job data into.

While the **Assign** dialog stays open in the background you'll enter the **New Project** dialog.

In the [General](#) page of the **New project** dialog:

- Under **Location** browse to where you want the Project to be stored. By default projects are stored in *C:\Documents and Settings\All Users\Documents\LGOP\Projects*.
- Enter the **Project Name**, e.g. *MAP*. A directory of the same name will be added to the path automatically. The project files will be stored into this directory.
- Click **OK**. The new project will be created and the dialog will be closed. You are returned to the **Assign** dialog.



In the **Assign** dialog the new project is selected automatically.

- Click **Assign** and then **Close**. The job data will be assigned to the new project and the **Project window** opens automatically.

The objective is to **copy and paste** the local grid coordinates of each common point into the Image Referencing component. To achieve this switch to the  **Points** view and proceed as follows:

- Switch the coordinate representation from *WGS84* to *Local Grid* via the **Coordinate Format** toolbar



- Multi-select points M1, M2, M3 and M4.
- Click onto the  **Copy** button in the **Standard** Toolbar. The *local grid* coordinate triplets for all four points will be copied to the clipboard.
- Go to the  **Image Referencing** component again and paste  the *local grid* coordinate triplets of M1, M2, M3 and M4 into the report view.

When you have successfully copied the *local grid* coordinates of all four common points into the **Image Referencing** component proceed with matching the *image* coordinates of each point with its *local grid* coordinates.

- **Rename** the image points from **1, 2, 3 and 4** to **M1, M2, M3 and M4**. Now *image* points and *local grid* points have the **same** Points Ids so that you may **Auto match** all common points in one go.
- In the **report view** of the Image Referencing component right-click and select **Auto match points** from the context menu.

Alternatively, select a pair of common points (e.g. point **1** and **M1**) and then select **Match point** from the context menu to match a single pair of points.

The points will be matched and the image may be referenced:

- Right-click again into the report view of the **Image referencing** component and select **Reference image** from the context menu. A little "R" (**R**) in the top right corner indicates that the image is referenced.

Congratulations! - You have successfully referenced a background image within LGO.

The image is referenced now to the local grid (**utm32**) that will also be used in the following Quick Tours and is ready for use with the TPS Sample project that will be used in the following Quick Tours for importing and updating the TPS sample data.

TPS Tour II: Manually updating setups

TPS Tour II: Manually updating setups

This Quick Tour is a step-by-step tutorial in which you learn how to update different setup types.

To complete this exercise the **TPS-Processing** option has to be included in your **licence**.

Three individual TPS survey jobs (two Smart Station setups and one Resection) are to be imported into the same project *TPS Sample*. Some updates need to be made to the data before it finally fits together.

A background image of the area where the measurements have taken place has been attached to the project. This gives you the chance to immediately see how the measurements should be located after the setups have been updated: A street (indicated by Lines) must be "rotated" into place, just as the measured corners of buildings.

In all three jobs a so-called checkpoint (**Check-1**) has been measured. When in the end the measurements of the averaged point fit together, all updates have been performed correctly.

Job JOB_1 - Contains a Smart Station setup with a **Set Orientation** to the **initially unknown** backsight point **BS-01**. This backsight point has been measured in job **JOB_2**. The coordinates of the setup point **ST_01** are known. They have been determined using a nearby GPS 1200 reference station. In the field the coordinate system **utm32** was used to derive local grid coordinates. During **Import** the same coordinate system will be attached to the project in LGO. But the TPS observations made from this setup all have a wrong orientation because of the initially unknown backsight coordinates. The Azimuth was set to 0.0 gon and the backsight point **BS-01** got preliminary local grid coordinates. As a result the street which was measured in the field (**P001...P029**) and the building points (**B-001...B003**) seem to be located in the "wrong" place. After the setup will have been updated the points will be shifted and you will see that the street and building corners fit to the background image.

Job JOB_2 – Setup on Known Point with **Known Backsight** orientation to a point of known coordinates (control point **1000**). Again a Smart Station has been setup on point **ST_02**. The coordinates of **ST_02** have been determined by the GPS reference **System 1200**. Again the coordinate system **utm32** was used to derive local grid coordinates. Since the backsight point is known in this job this setup is complete and correctly oriented. The coordinates of the backsight point **BS-01** from **JOB_1** are determined from this setup and will be used in LGO to update the first setup.

Job JOB_3 – **Resection** setup using two points (**R-01** and **R-02**) measured from **JOB_1**. When the resection was measured in the field the coordinates of **R-01** and **R-02** were still preliminary. This fact has to be accounted for in LGO once the first setup has been updated with the help of the data coming from **JOB_2**.

The data sets will be used in the following way:

1. Importing the job **JOB_1**. The setup and orientation of the job **JOB_1** (and therefore the measured points from **JOB_1**) will be updated by the data from job **JOB_2**.
2. Importing the job **JOB_2** and updating the first setup by the help of the now known backsight point of **JOB_1**.
3. Then job **JOB_3** will be imported. The resection is initially wrong since it used "not yet updated" coordinates from **JOB_1**. We will update this resection within LGO.

Start this Quick Tour with: [TPS Tour II - Lesson 1: Importing the TPS data of JOB_1](#).

TPS Tour II - Lesson 1: Importing and inspecting the TPS data of JOB_1

The objectives of this lesson are:

- To import the first set of TPS data collected in a job called **JOB_1**.
- To create a new project during the import procedure and attach the **background image** *Leica Areal-map* to it.
- To inspect the **View/Edit** view and the **TPS-Proc** view for what has been imported so far: to see the need for updating the first setup.

Now, start with importing the System 1200 TPS survey job **JOB_1** into the project *TPS Sample*.

- Select  **Import Raw data** either from the **Import** main menu or from the Toolbar or from the Tools [List Bar](#).

The [Import Raw Data](#) dialog opens. In this dialog:

- Select **SmartWorx raw data** under **Files of type**.
- Browse to the directory that contains the sample data under **Look in**. By default the sample data for this tutorial will be installed in *C:\Documents and Settings\All Users\Documents\LGO\Sample data\Import\TPS\Job_1*.**
- Select **JOB_1** to be imported.
- Click the **Import** button.

The **Assign** dialog opens. In this dialog:

- In the [Settings](#) tab ensure that the **Import 'use flag' status for averaged points** and the **Import coord system & components** flags are ticked.

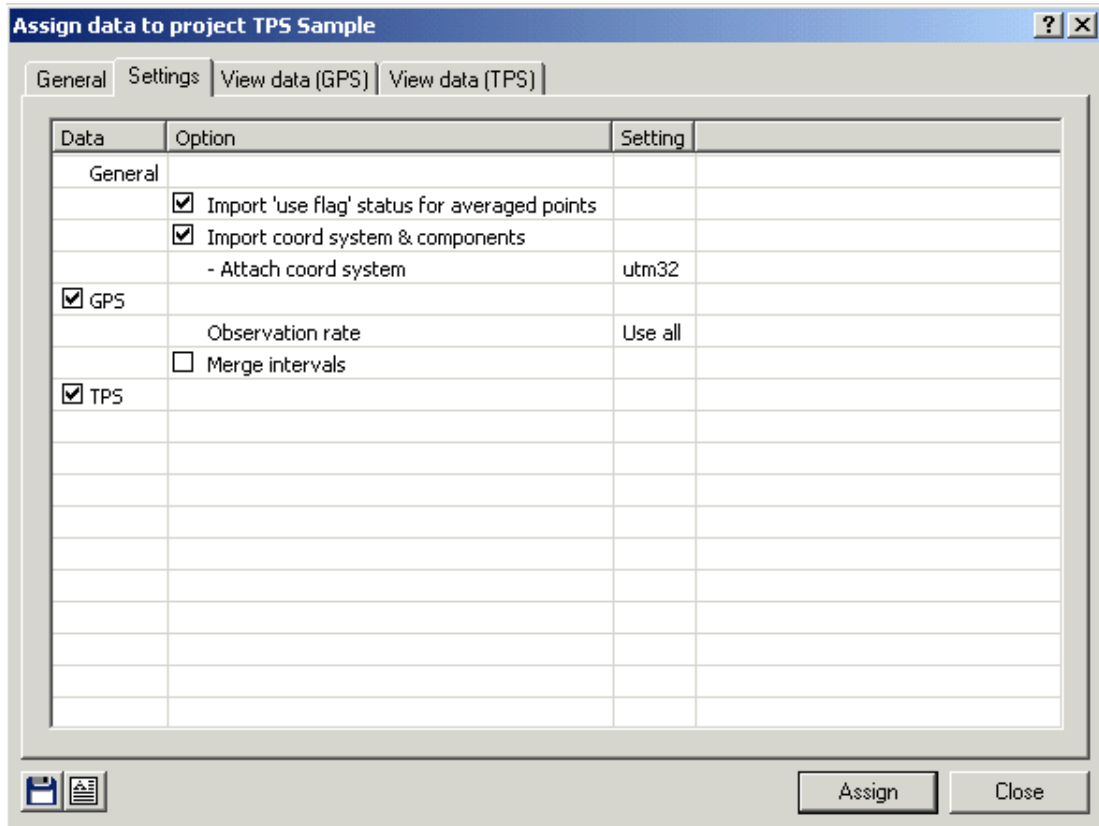

- In the **General** tab right-click on **Projects** in the tree-view and select **New...** from the context menu to create a new project to import the job data into.

While the **Assign** dialog stays open in the background you'll enter the **New Project** dialog.

In the [General](#) page of the **New project** dialog:

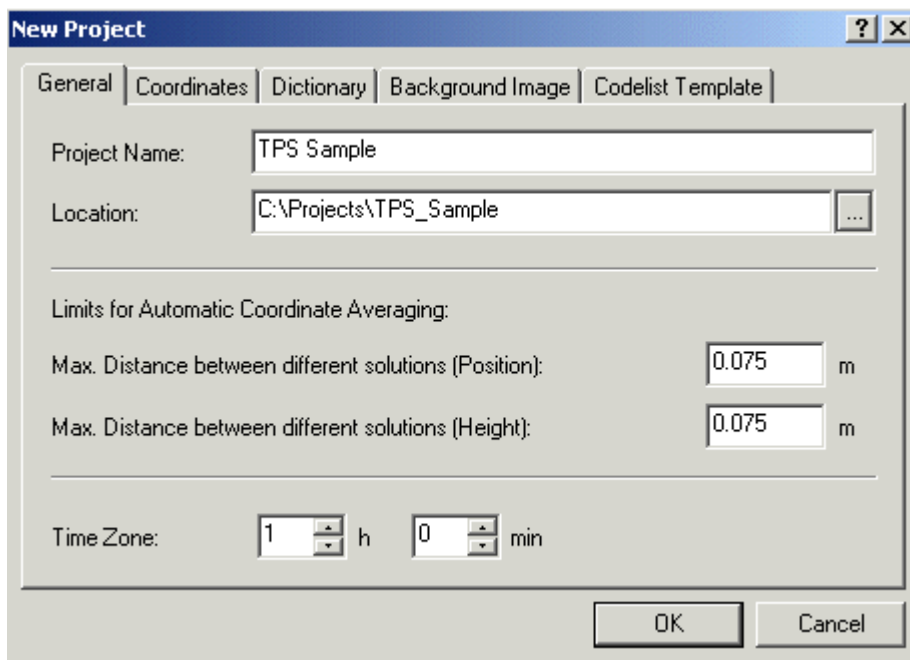

- Under **Location** browse to where you want the Project to be stored. By default projects are stored in *C:\Documents and Settings\All Users\Documents\LGO\Projects*.
- Enter the **Project Name**, e.g. *TPS Sample*. A directory of the same name will be added to the path automatically. The project files will be stored into this directory.
- Go to the [Background Image](#) page and select the image *Leica Areal-map* from the combo box. The image has been referenced in the previous [TPS Tour](#).

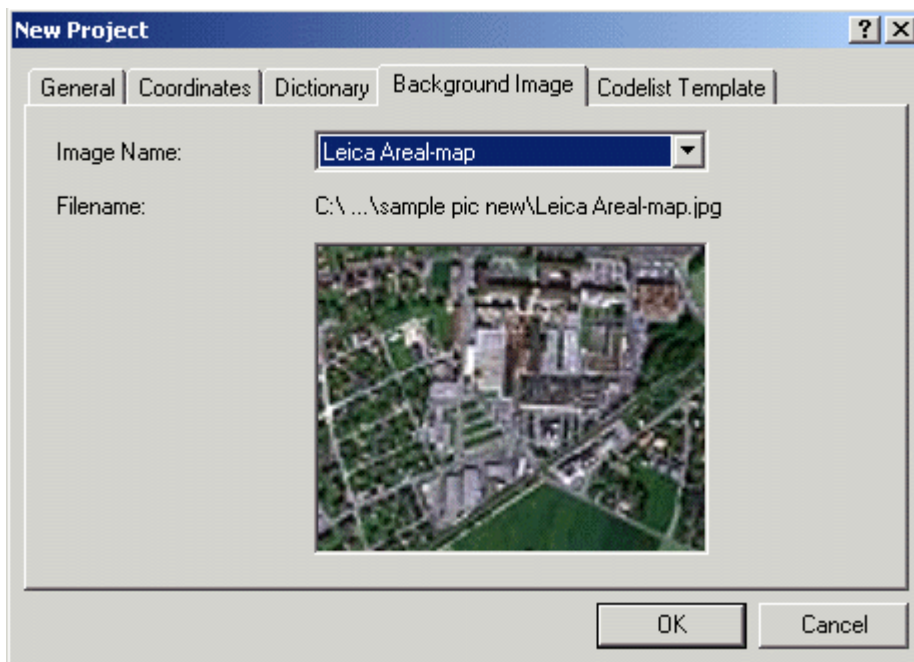

- Click **OK**. The new project will be created and the background image will be attached to it. The **New Project** dialog will be closed. You are returned to the **Assign** dialog.

In the **Assign** dialog the new project is selected automatically.

- Click **Assign** and then **Close**. The job data will be assigned to the new project and the **Project window** opens automatically.

In the  **View/Edit** tab you will see the [following](#) after **Import**:

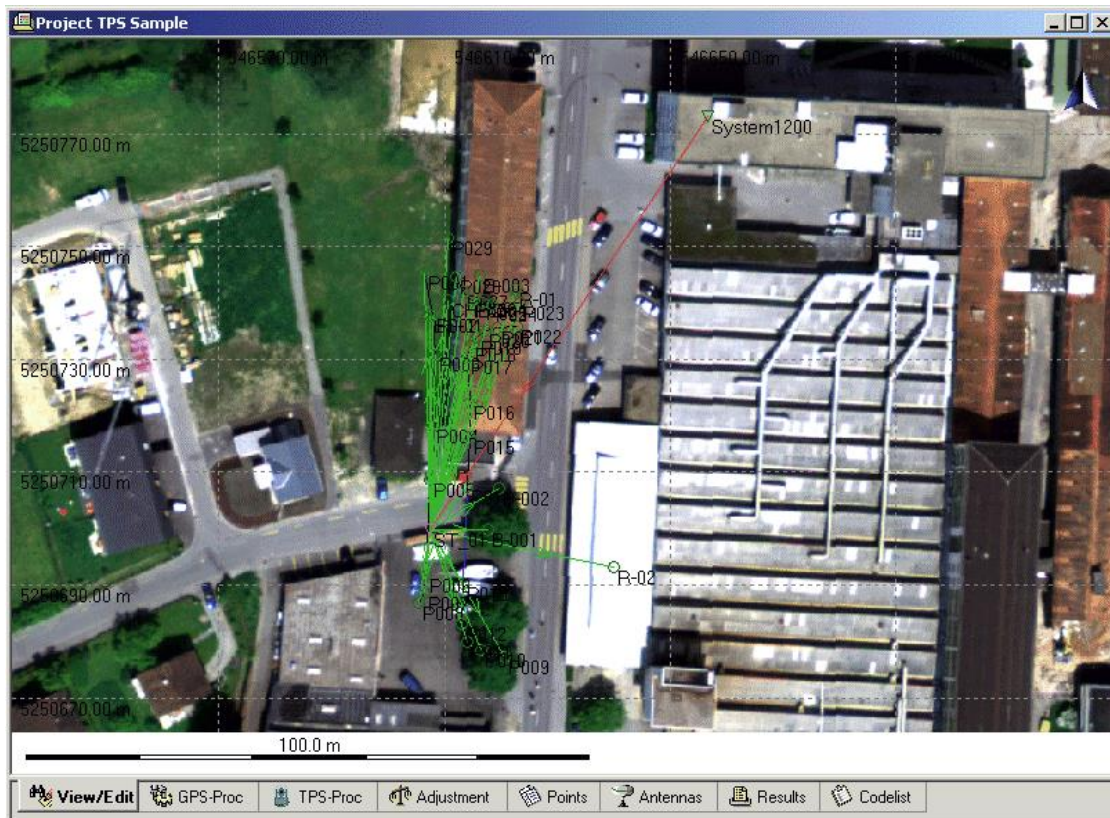

To inspect the TPS data proceed as follows:

1. Blend the image to better distinguish the observations from the background image: Right-click into the image and select **Blend image** from the background menu.
2. Change the Line Properties of the street representation such that the lines become thicker and stick out better from the arrows of the TPS observations: Right-click onto the lines belonging to the street and select **Properties...** from the context menu. In the **Line Properties** dialog change the **Line Width** to 1 1/2 pt.

Now you can clearly see the street that has been measured in the field. It has been measured from the Smart Station setup **ST_01**. The GPS Reference **System1200** was set up on a roof. ST_01 has thus known coordinates.

But, it seems that the street is placed incorrectly. It should be rotated to the left. The reason for this "incorrectness" is that the set of TPS observations measured from ST_01 has only a preliminary orientation.

- Go to the  **TPS-Proc** view and invoke the **Setup Properties** for ST_01.

In the [General](#) page you can see that all TPS observations measured from this setup are measured with the **Set Orientation** method. In this case the known Azimuth has preliminarily been set to 0.0 gon in the field, because the coordinates of the backsight point BS-01 were still unknown. They have been derived in a second job **JOB_2**.

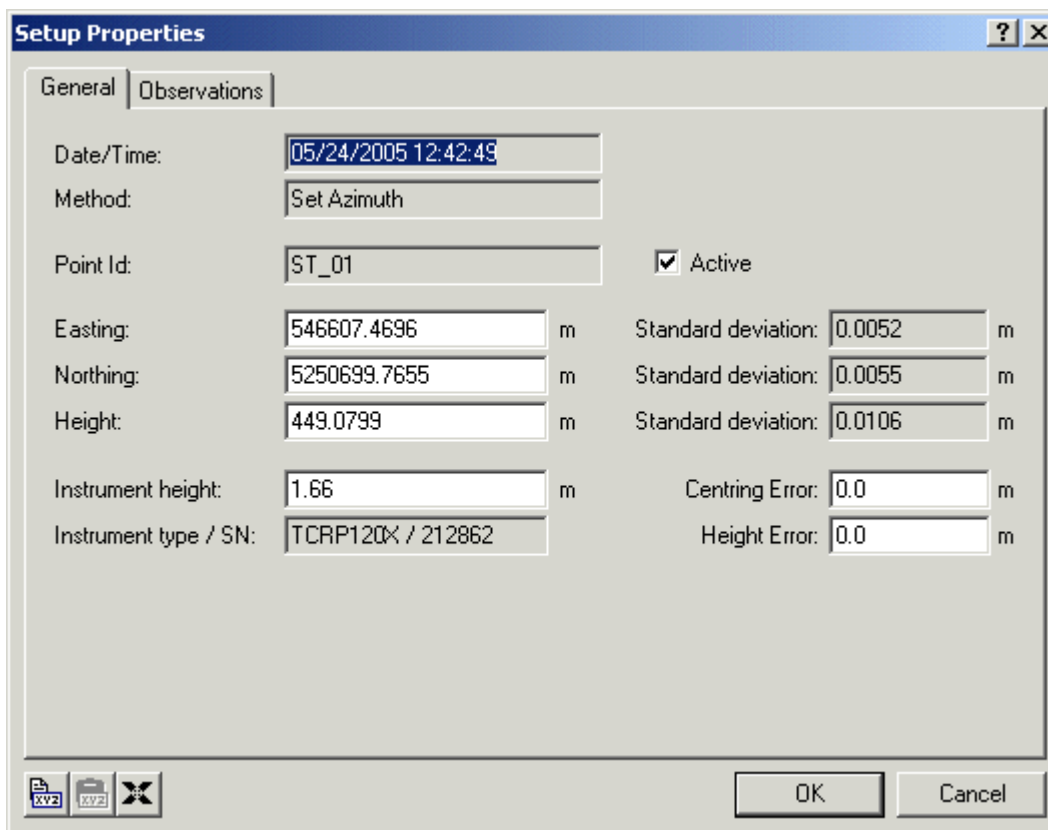

In LGO the Azimuth has to be **recalculated** to receive the correct orientation. For that the correct coordinates of the backsight BS-01 have to be known. They will be imported from JOB_2 in the next lesson.

Once the Azimuth value to BS-01 is recalculated the road and all other points measured from ST_01 will be rotated into the "right" place. Among these other points are three building points B-001...B-003, two points (R-01 and R-02) which will be used for a resection calculation in Lesson 4 and the checkpoint CHECK-1. At the end of this Quick Tour CHECK-1 will have been imported three times. The objective is to receive mean coordinates for CHECK-1 which fit together.

Continue with [TPS Tour II - Lesson 2: Importing the TPS data of JOB_2](#).

TPS Tour II - Lesson 2: Importing and inspecting the TPS data of JOB_2

The objectives of this lesson are:

- To import the second set of TPS data collected in a job called **JOB_2**.
- To make sure that the correct coordinates are used for the backsight point **BS-01**.

Now, continue with importing the System 1200 TPS survey job **JOB_2** into the same project *TPS Sample*.

- Again select  **Import Raw data** either from the **Import** main menu or from the Toolbar or from the Tools **List Bar**.

The **Import Raw Data** dialog opens. In this dialog:

- Select **SmartWorx raw data** under **Files of type**.
- Browse to the directory that contains the sample data under **Look in**. By default the sample data for this tutorial will be installed in *C:\Documents and Settings\All Users\Documents\LGO\Sample data\Import\TPS\Job_2*.**.
- Select **JOB_2** to be imported.
- Click the **Import** button.

The **Assign** dialog opens. In this dialog:

- In the **General** tab make sure that the project *TPS Sample* is selected for import.
- Click **Assign** and then **Close**. The job data will be assigned to the project *TPS Sample* and you are returned to the **Project window** automatically.

During the Import procedure you will get the 'Averaging limit exceeded' message for two points. Back in the [View/Edit](#) tab you can immediately identify these points as the backsight point **BS-01** measured from ST_01 and the checkpoint **CHECK-1**.



See the **Point Properties** for both points.

- First go to the [Point Properties: Mean](#) page for **CHECK-1**. You will see that the Position difference between the measurements from ST_01 and from ST_02 is more than 60m. This is because the measurement from ST_01 still has the "wrong" orientation.

Point Properties [?] [X]

General | Stochastics | Thematical Data | **Mean**

Point Id: CHECK-1

Averaging Limit
Position: 0.0750 m Height: 0.0750 m

Current Mean Coordinates
E: 546567.0493 m N: 5250694.1033 m Ortho. Hgt.: 449.0993 m
CQ: 0.0051 m

Use	State	Reference	Date/Time	Posn. diff	Hgt. diff	Posn. + Hgt. diff	Posn. + Hgt. diff
<input type="checkbox"/>	 Automatic	ST_01	05/24/2005 13:12:35	63.6678	0.0100	63.6678	
<input checked="" type="checkbox"/>	Automatic	ST_02	05/24/2005 14:18:21	0.0000	0.0000	0.0000	

Computed Mean Coordinates
E: 546567.0493 m N: 5250694.1033 m Ortho. Hgt.: 449.0993 m
Error Detection: 1 measurement(s) out of limit CQ: 0.0051 m

OK Cancel Apply

- Now, go to the [Point Properties: Mean](#) page for **BS-01**. Just as with CHECK-1 the measurement from ST_01 still has a preliminary orientation. Thus, it should be de-activated so that the measurement from ST_02 is taken.

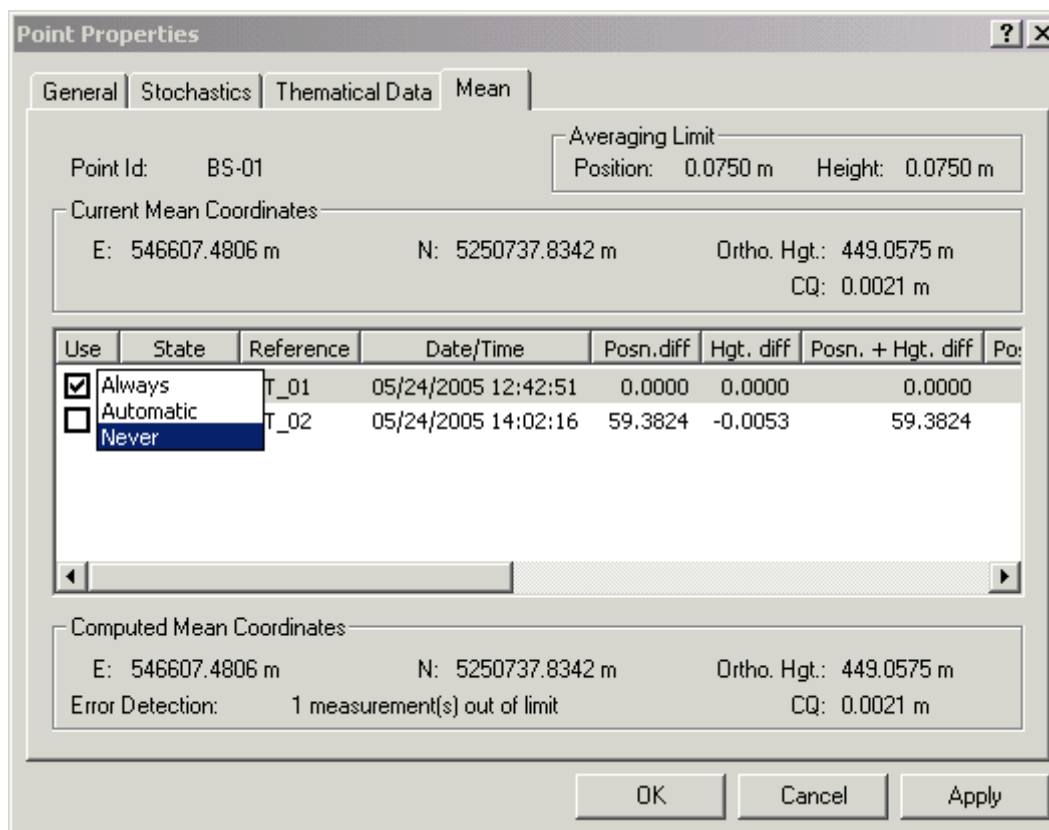

Right-click onto the Averaging Status (**State**) for the measurement form ST_01, select **Modify...** from the context menu and then **Never**. The measurement from ST_01 to BS-01 will not be used any more and you can be sure that for the **Update procedure** that we will go through in the next lesson the "right" coordinates of BS-01 are taken.

Now, continue with [TPS Tour II - Lesson 3: Manually update a Set Orientation setup.](#)

TPS Tour II - Lesson 3: Manually update a "Set Orientation" setup

The objectives of this lesson are:

- To recalculate the orientation for the first setup ST_01.
- To update the "Set Orientation" setup ST_01 and all related measurements.
- To check the average for the checkpoint CHECK-1.

After having successfully imported the first two jobs and after having modified the average for BS-01 you should see the [following](#) in  **View/ Edit**.

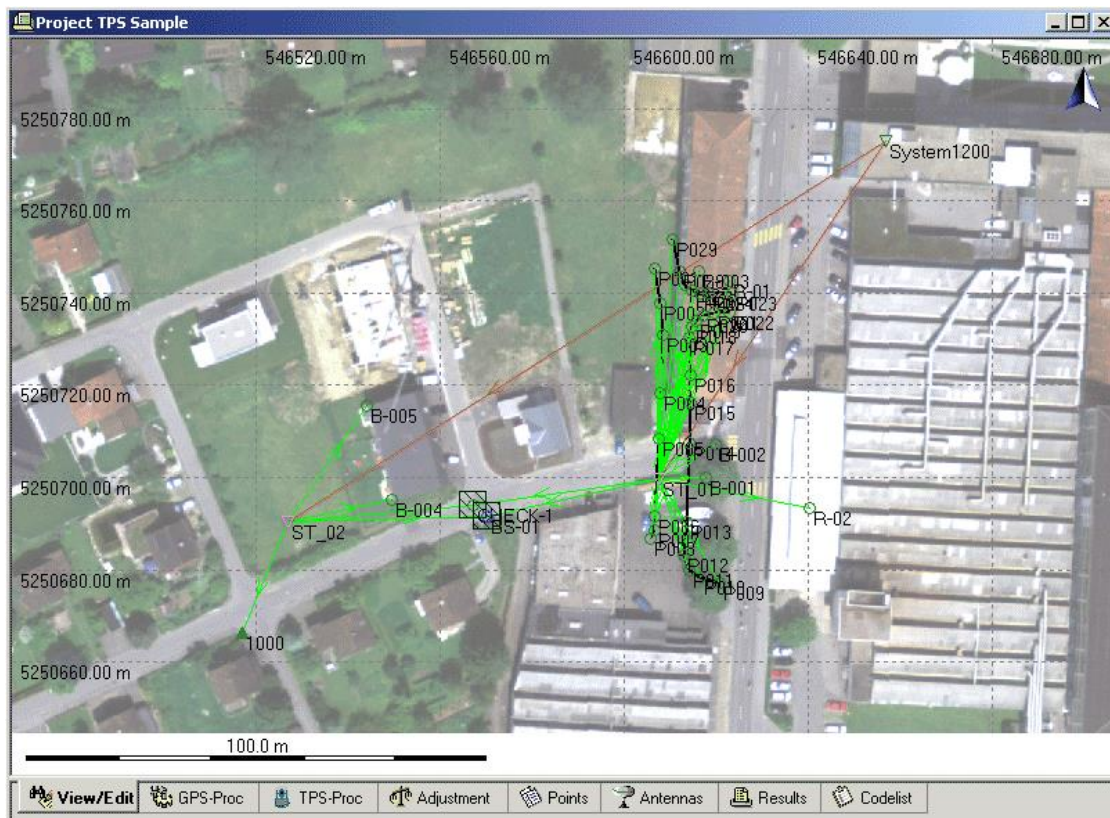

In comparison with the background image you can see that the building corners **B-004** and **B-005** measured from ST_02 are in the correct places already. **BS-01** is in the correct place, too. But all the other observations measured from ST_01 still have to be updated.

The Station coordinates of ST_02 have been derived from the GPS 1200 reference and are therefore **correct**. The backsight point 1000 has come from a **control** job and therefore this setup is **complete and correctly oriented**. The point which was used as the backsight point from the first setup (BS-01) is measured from ST_02. Therefore, the orientation of the first setup can be updated now:

1. In the  **TPS-Proc** tab access the **Setup Properties** dialog for ST_01.
2. Go to the [Observations](#) page and ensure that the **Backsight Point ID** radio button is checked. The point **BS-01** should be chosen as the backsight point.

Note:

In the **Easting/ Northing/ Height** list boxes the **current** local grid coordinates of BS-01 are shown. These coordinates will be used to update the first setup. But what are the current coordinates of the BS-01?

Remember, that before updating the setup the measurement from ST_01 to BS-01 just has a preliminary orientation. The measurement from ST_02 to BS-01 delivered correct coordinates. Thus, the measurement from ST_01 has been de-activated in the previous lesson so that the measurement from ST_02 is taken for the Update procedure.

3. Press **Recalculate** to recalculate the Orientation.
4. Press **OK** to update the setup (ST_01) and all related measured points.

Now, leave the TPS-Proc view and go back to the **View/Edit** view. You'll immediately notice the effects of the update:

- The representation of the street has been rotated according to the newly computed orientation. It now perfectly fits to the street in the background image.
- The averaging limit is no longer exceeded for BS-01 and CHECK-1. See the [Point Properties: Mean](#) page for CHECK-1. Both instances of CHECK-1 are used to calculate the average and the result does not exceed the limit.

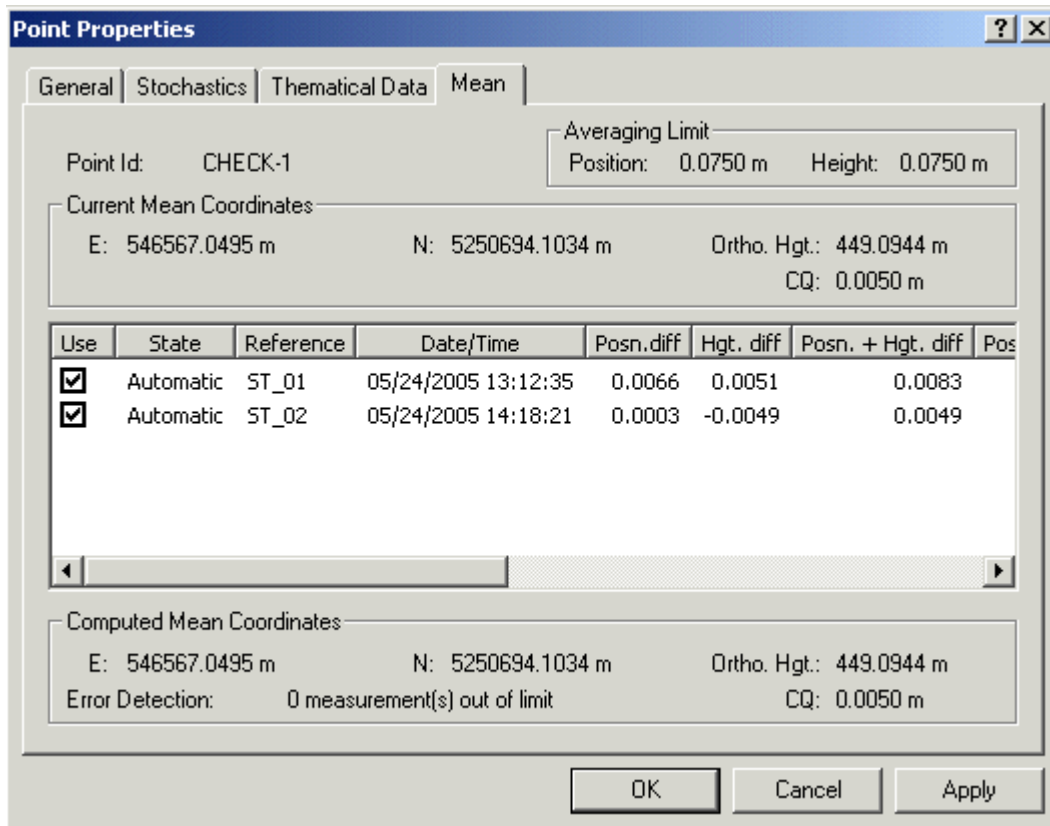

Congratulations! - You have successfully updated the first setup!

Continue with [TPS Tour II - Lesson 4: Importing the TPS data of JOB_3.](#)

TPS Tour II - Lesson 4: Importing the TPS data of JOB_3

The objectives of this lesson are:

- To import the third set of TPS data collected in a job called **JOB_3**.
- To inspect the averages of three points for which the averaging limit is exceeded after import.
- To confirm that the correct coordinates are used for the resection target points **R-01** and **R-02**.

A third job **JOB_3** has been measured in the field which shall now be imported into the same LGO project *TPS Sample*. The job has been measured in the same area and the data should fit to the data coming from the first two jobs in the end.

- Again select  **Import Raw data** either from the **Import** main menu or from the Toolbar or from the Tools **List Bar**.

The **Import Raw Data** dialog opens. In this dialog:

- Select **SmartWorx raw data** under **Files of type**.
- Browse to the directory that contains the sample data under **Look in**. By default the sample data for this tutorial will be installed in *C:\Documents and Settings\All Users\Documents\LGO\Sample data\Import\TPS\Job_3*.**
- Select **JOB_3** to be imported.
- Click the **Import** button.

The **Assign** dialog opens. In this dialog:

- In the **General** tab make sure that the project *TPS Sample* is selected for import.
- Click **Assign** and then **Close**. The job data will be assigned to the project *TPS Sample* and you are returned to the **Project window** automatically.

During the Import procedure you will get the 'Averaging limit exceeded' message for three points. Back in the [View/Edit](#) tab you can immediately identify these points as the resection target points **R-01** and **R-02** measured from **ST_03** and the checkpoint **CHECK-1**.

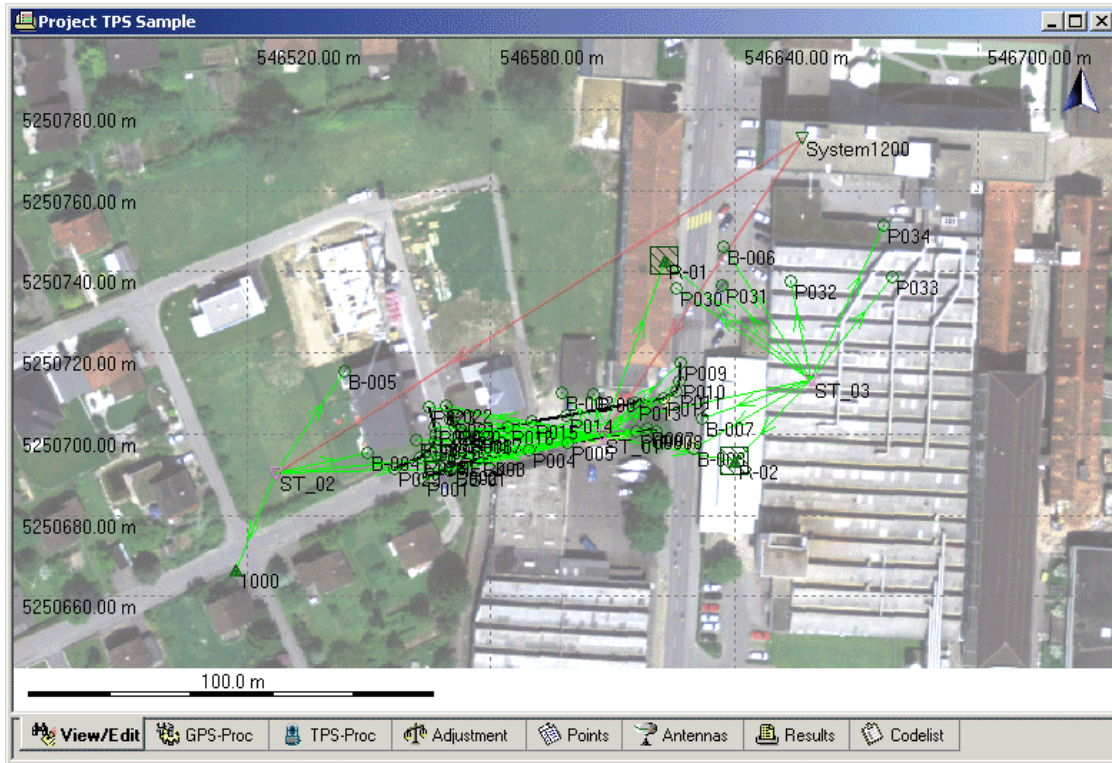

See the **Point Properties** for all three points.

- First go to the [Point Properties: Mean](#) page for **CHECK-1**. After the first setup ST_01 has been updated in LGO the first two measurements (from ST_01 and from ST_02) fit together. But the measurement coming from ST_03 exceeds the averaging limit. Again the Position difference is more than 60m.

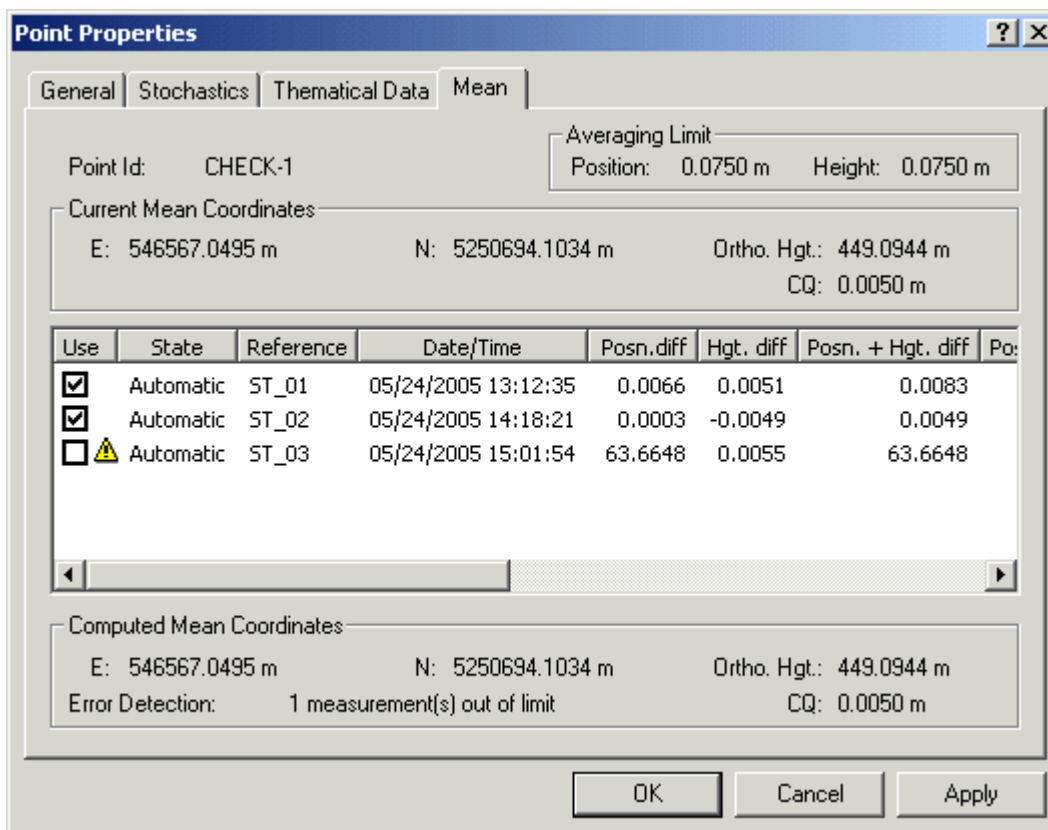

The reason for this is that the resection target points R-01 and R-02 that were used for the setup computation in the field still had the "wrong" coordinates coming from the preliminarily oriented ST_01. As a consequence the resection setup ST_03 is also "wrong" with respect to position and orientation and all points that were measured from ST_03 -among them CHECK-1- also received "wrong" coordinates.

From all three setups CHECK-1 was measured as a **Survey Observation** with the averaging flag (**State**) of *Automatic*. The aim is that after updating ST_03 none of the three measurements of CHECK-1 exceeds the averaging limit any more.

- Now, go to the [Point Properties: Mean](#) pages for **R-01** and **R-02**. R-01 and R-02 served as the two known resection target points in the field. The coordinates of these "known" points came from the setup ST_01 which had not yet been updated in the field. R-01 and R-02 still had "wrong" coordinates at the time when they were used for the resection. Thus the resection setup is also "wrong", i.e. wrongly oriented when it is imported into LGO.

Point Properties [?] [X]

General | Stochastics | Thematical Data | Mean

Point Id: R-01

Averaging Limit
Position: 0.0750 m Height: 0.0750 m

Current Mean Coordinates
E: 546562.3785 m N: 5250705.4035 m Ortho. Hgt.: 448.9736 m
CQ: 0.0051 m

Use	State	Reference	Date/Time	Posn. diff	Hgt. diff	Posn. + Hgt. diff	Posn. + Hgt. diff
<input checked="" type="checkbox"/>	Automatic	ST_01	05/24/2005 13:21:55	0.0000	0.0000	0.0000	0.0000
<input type="checkbox"/>	 Never	ST_03	05/24/2005 14:53:58	70.8833	0.0019	70.8833	70.8833

Computed Mean Coordinates
E: 546562.3785 m N: 5250705.4035 m Ortho. Hgt.: 448.9736 m
Error Detection: 1 measurement(s) out of limit CQ: 0.0051 m

OK Cancel Apply

In the field all measurements fitted together, but after ST-01 has already been updated in LGO (in the previous lesson) the coordinates of R-01 and R-02 coming from **JOB_3** differ significantly from the already updated coordinates. After having successfully updated ST_03, too, the averaging limit will no longer be exceeded for R-01 and R-02 and all points triplets will correctly fit together again.

Now, please note that the coordinates coming from JOB_3 have the averaging flag of *Never*. This is due to the fact that points that have been used in the field as **Resection target points** always receive the averaging flag of *Never*. As a consequence the measurements from ST_03 to R-01 and R-02 will not be used. For both the already "correctly" oriented (updated) measured triplets coming from ST-01 as **Survey Observations** will be used and you can be sure that for the **Update procedure** that we will go through in the next lesson the "right" coordinates of R-01 and R-02 are taken. Survey observations typically get the averaging flag of *Automatic*.

Now, continue with [TPS Tour II - Lesson 5: Manually update a Resection setup](#).

TPS Tour II - Lesson 5: Manually update a "Resection" setup

The objectives of this lesson are:

- To recalculate the coordinates and the orientation for the third setup ST_03.
- To update the "Resection" setup ST_03 and all related measurements.
- To check the average for the checkpoint CHECK-1.

After having successfully imported the job **JOB_3** you should see the [following](#) in  **View/ Edit**.

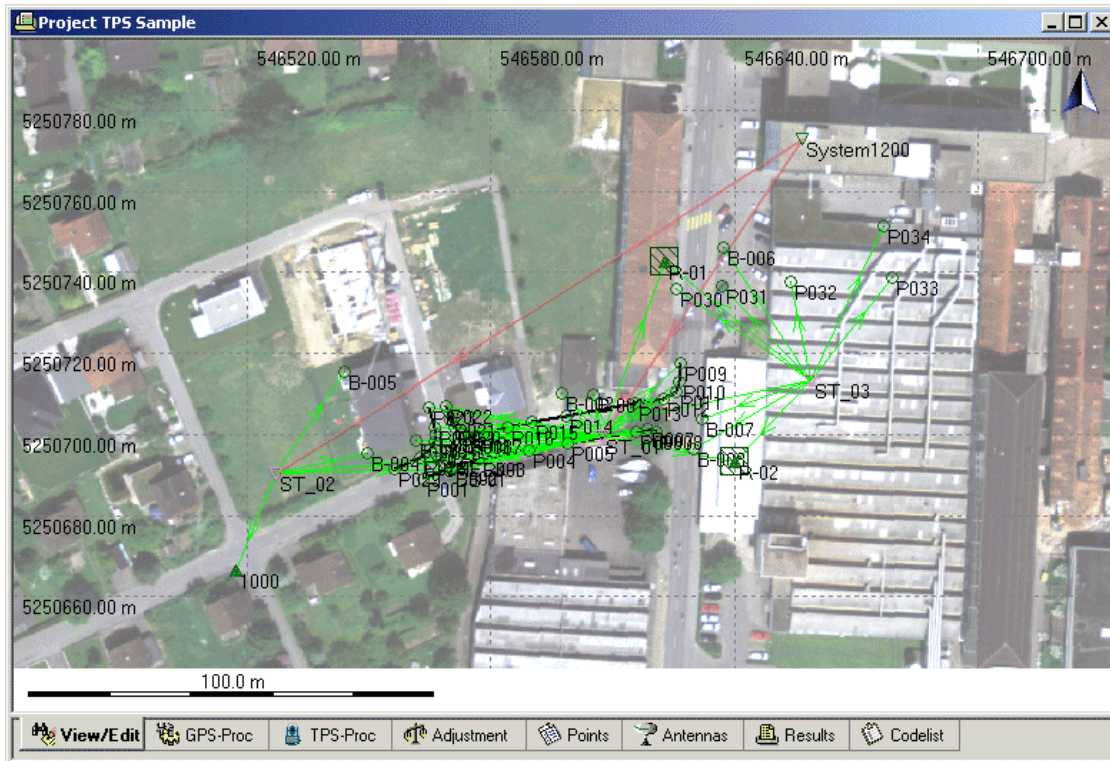

The coordinates of the resection target points **R-01** and **R-02** are "known".

In the field they were taken from the Fixpoint Job **JOB_1**. Internally both points were copied as *Control* points into **JOB_3** and were then used for the resection as *Setup Observations*. When importing **JOB_3** into LGO these *Control* triplets are taken as the **current** coordinates since the *Control* triplets have the highest point class for R-01 and R-02.

But we do not want these *Control* triplets to be further used in LGO since they correspond to the coordinates measured from the not yet updated Smart Station setup **ST_01** in the field. We want the updated coordinates coming from **ST_01** to be taken.

Thus, the *Control* triplets have to be deleted to make the *Measured* triplets become the **current** coordinates. The *Measured* triplets for R-01 and R-02 correspond to the coordinates coming from the already updated setup **ST_01**. We have already seen in the **Point Properties: Mean** pages for R-01 and R-02 that the preliminary coordinates coming from **ST_03** will certainly not be used (they have the averaging flag of *Never*). After deleting the *Control* triplets the resection target points will appear at the "correct" position in **View/ Edit**.

What is still left to be done after that is to re-calculate the orientation of **ST_03** with respect to the updated

coordinates of R-01 and R-02. After the setup has been updated all related points will be updated, too. The third measurement of checkpoint CHECK-1 should then fit together with the first two instances.

1. Delete the **Control** triplets for R-01 and R-02. For each of the two points right-click on the point and select **Delete - Triplets - Control** from the context menu.
2. **Update** the resection. To do so access the  **TPS-Proc** tab. Invoke the **Setup Properties** for ST_03 and go to the [Observations](#) page. The coordinates displayed for the resection target points R-01 and R-02 are now correct.

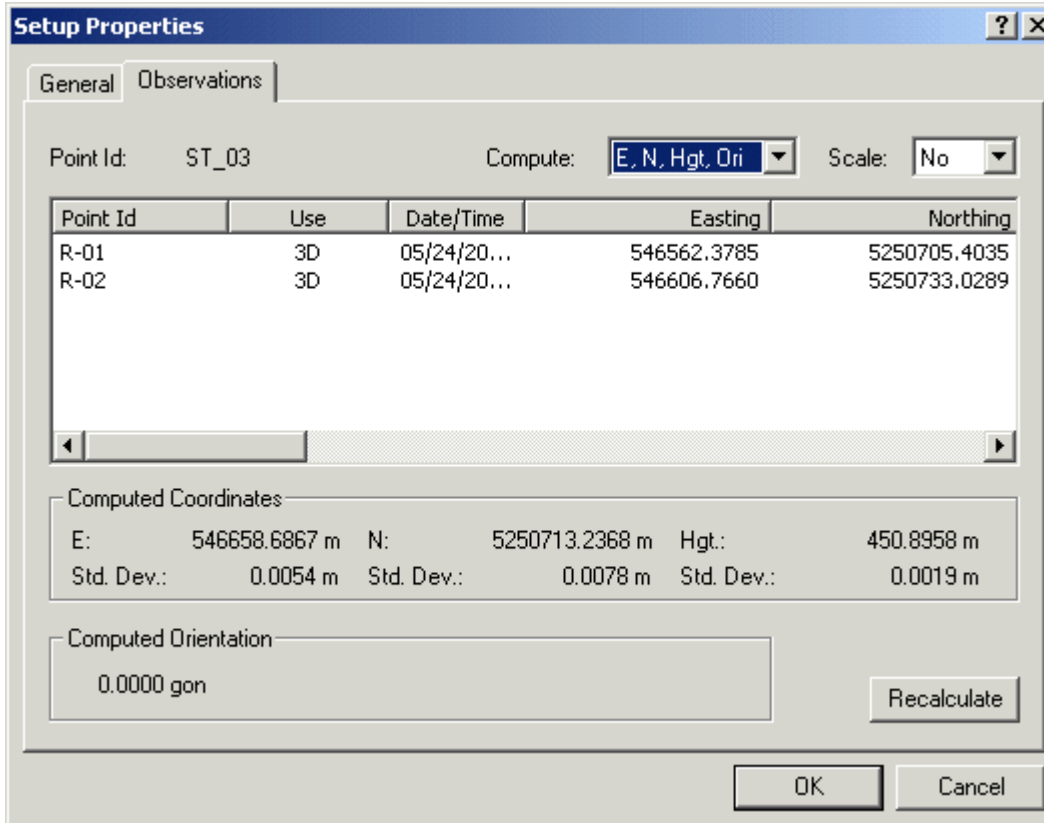

Setup Properties

General Observations

Point Id: ST_03 Compute: E, N, Hgt, Ori Scale: No

Point Id	Use	Date/Time	Easting	Northing
R-01	3D	05/24/20...	546562.3785	5250705.4035
R-02	3D	05/24/20...	546606.7660	5250733.0289

Computed Coordinates

E: 546658.6867 m N: 5250713.2368 m Hgt.: 450.8958 m
 Std. Dev.: 0.0054 m Std. Dev.: 0.0078 m Std. Dev.: 0.0019 m

Computed Orientation

0.0000 gon

Recalculate

OK Cancel

3. Press **Recalculate** to re-compute the orientation
4. Press **OK** to update the setup ST_03 and all related measured points.

Access the  **View/ Edit** tab again and see that everything fits [now](#).

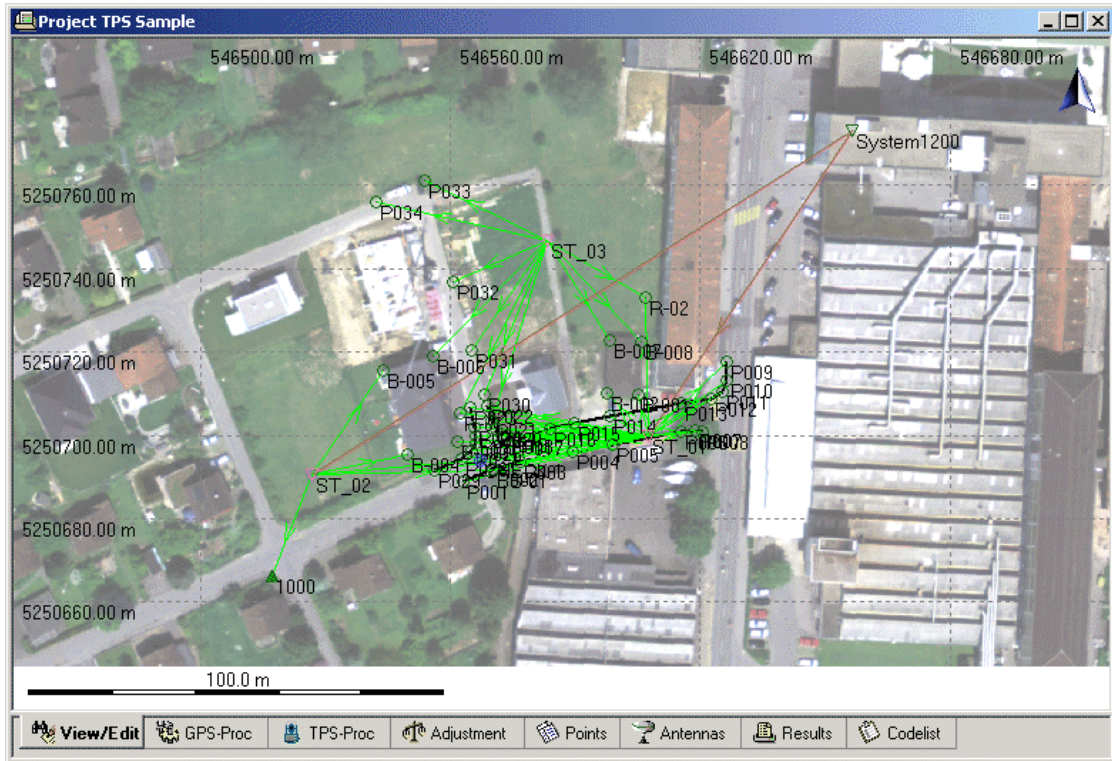

- First go to the [Point Properties: Mean](#) page for CHECK-1. See that all three measurements fit into the averaging limit now. This is our main proof that all the data has been updated correctly.

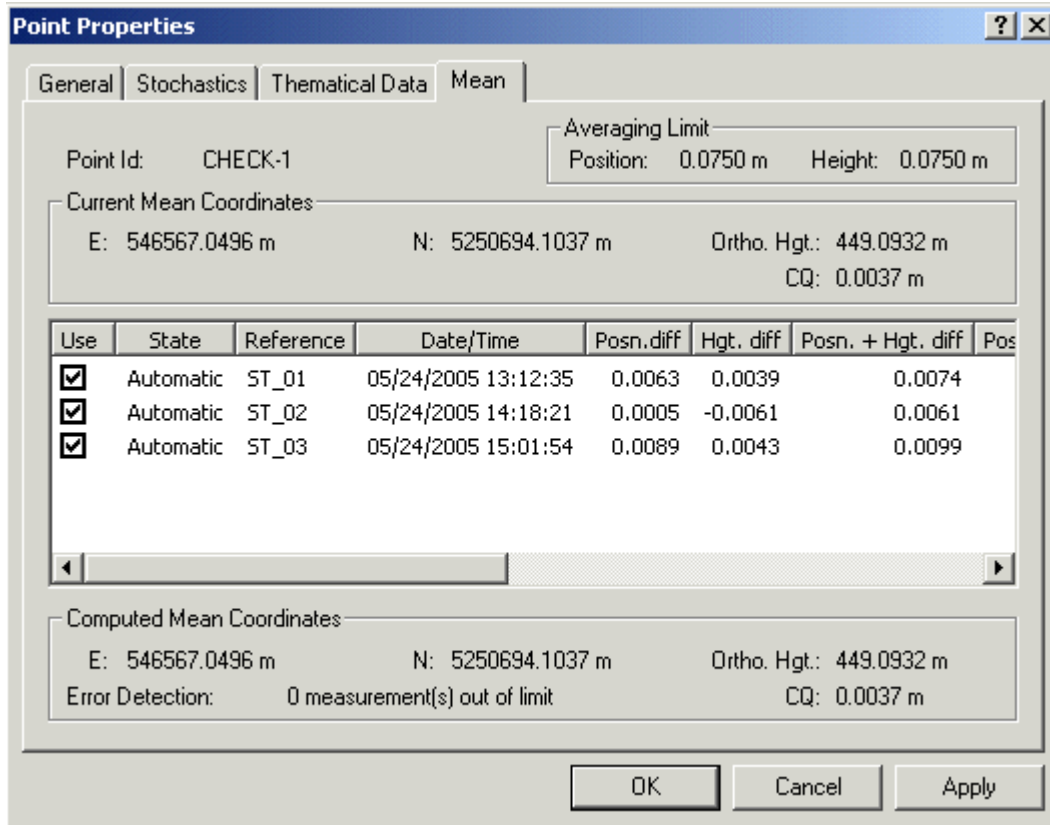

- The averaging limit exceeded for R-01 and R02 has also disappeared. After updating the setup the measurements from ST_03 fit together with the measurements from the already updated ST_01.
- Further note that in comparison with the background image the Station ST_03 has moved down from the roof to a reasonable point in the field.
- The street points P030...P034 are in line now with the already existing street points.
- The points B006...B008 complete the buildings of which the other corners have already been measured in JOB_1 and JOB_2.

Congratulations! - You have successfully completed Quick Tour II.

TPS Tour III: Automatically updating setups

TPS Tour III: Automatically updating setups

This Quick Tour is a step-by-step tutorial in which you follow three objectives:

1. How to **automatically update** several "Set Orientation" setups in one go.
2. How to **exchange a preliminary coordinate system** used on a Smart Station with the final coordinate system.
3. How to **correct the target height** for several target points.

To complete this exercise the **TPS-Processing** option has to be included in your **licence**.

One TPS Survey job (containing three Smart Station setups) and one GPS survey job are to be imported into the project *TPS Sample*. The jobs have been measured in the same area as the jobs in Quick Tour II, but with a different coordinate system. In this Quick Tour first a preliminary coordinate system is used which has to be **exchanged** in the end with the **utm32** coordinate system that has been used in Quick Tour II. You will see then how the survey points "move" into the area of the attached background image and how the representation of the measured parking lot and trees fit to the image after a successful update procedure.

In this Quick Tour imagine the following scenario:

Job JOB_4 - A parking lot and some trees have been measured from three different Smart Station Setups. Since a Smart Station was used on all three setup points (**ST_04**, **ST_05** and **ST_06**) the coordinates of these points are known. Again the station **System1200** on the roof served as the GPS reference. A preliminary coordinate system (called **CAR_PARK_OS**) was used to derive local grid coordinates. But the point which was intended to be used as the **Known Backsight** was, unfortunately, blocked by a truck. Thus, the survey crew had to orientate the TPS instrument to a preliminary backsight point (called **C_B_1**). The orientation to **C_B_1** was preliminarily set to 0.0 gon which implied that the backsight point did not have "known" coordinates then.

Job JOB_5 - The survey of the parking lot was completed with GPS and the TPS backsight point **C_B_1** received known coordinates from GPS. The same preliminary coordinate system (**CAR_PARK_OS**) is used to convert the WGS84 coordinates coming from GPS to local grid.

In LGO it is easy now to put the puzzle together. With an automated update procedure all three TPS setups will receive the correct orientation in one go. The elements will be rotated thus that the representation of the parking lot fits together with the attached background image.

The data sets will be used in the following way:

1. Importing the job **JOB_4**. The setups that have been measured in **JOB_4** and the orientation of all related measured points will be automatically updated by the data from **JOB_5**.
2. Importing the job **JOB_5** and automatically update the setups from **JOB_4** by the help of the now known backsight point **C_B_1**.
3. Exchanging the preliminary coordinate system with the final **utm32** coordinate system.
4. Correcting the target height for the backsight observation (the **Setup Observation**) measured from **ST_05**. By mistake a wrong target height was entered on this setup in the field.

Correcting the target height for all **Survey Observations** measured from **ST_04**.

Start this Quick Tour with: [TPS Tour III - Lesson 1: Importing the TPS data of JOB_4](#).

TPS Tour III - Lesson 1: Importing the TPS data of JOB_4

The objectives of this lesson are:

- To import the fourth set of TPS data collected in a job called **JOB_4**.
- To reflect upon the use of coordinate systems within an LGO project.

A fourth job **JOB_4** has been measured in the field which shall now be imported into the same LGO project *TPS Sample*. The job has been measured in the same area and the data should fit to the data coming from the first three jobs in the end.

- Again select  **Import Raw data** either from the **Import** main menu or from the Toolbar or from the Tools **List Bar**.

The **Import Raw Data** dialog opens. In this dialog:

- Select **SmartWorx raw data** under **Files of type**.
- Browse to the directory that contains the sample data under **Look in**. By default the sample data for this tutorial will be installed in *C:\Documents and Settings\All Users\Documents\LGO\Sample data\Import\TPS\Job_4*. **
- Select **JOB_4** to be imported.
- Click the **Import** button.

The **Assign** dialog opens. In this dialog:

- In the **General** tab make sure that the project *TPS Sample* is selected for import.
- Click **Assign** and then **Close**. The job data will be assigned to the project *TPS Sample* and you are returned to the **Project window** automatically.

Don't be upset now! - Directly after import you may be surprised. The background image seems to have disappeared and two clusters of points are visible in the  [View/Edit](#) component. So, what has happened?

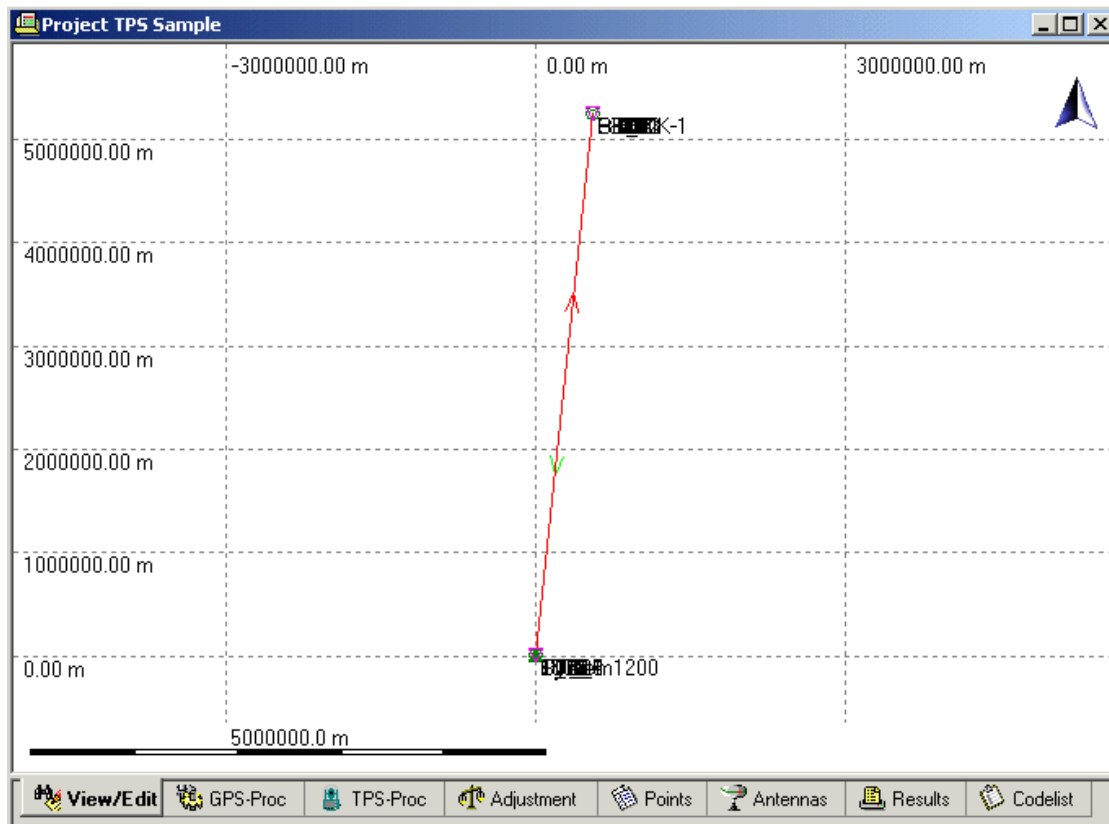

Remember, that in JOB_4 a preliminary coordinate system was used to derive local grid coordinates on the Smart Station in the field. This coordinate system differs significantly from the **utm32** coordinate system that has been used with the first three jobs.

When importing JOB_4 into the same project *TPS Sample* the coordinate system that has been attached to the project before (the **utm32** coordinate system) is replaced with the preliminary coordinate system used in JOB_4. As a result all the points which are stored in the WGS 84 coordinate system (among them the GPS reference Station **System1200**) are converted to the preliminary coordinate system now. This means that in View/ Edit the GPS reference System1200 "moves" to the second cluster of points coming from JOB_4.

- Now, first zoom in to the "upper" cluster of points coming from the first three jobs. See that the background image is still there. But the GPS reference **System1200** has "disappeared" from the roof.
- Now, zoom in to the ["lower" cluster of points](#) coming from JOB_4. Here you will find the GPS reference **System1200** again, fitting to the data from JOB_4. We will keep the view zoomed into the second cluster of points during the following lessons.

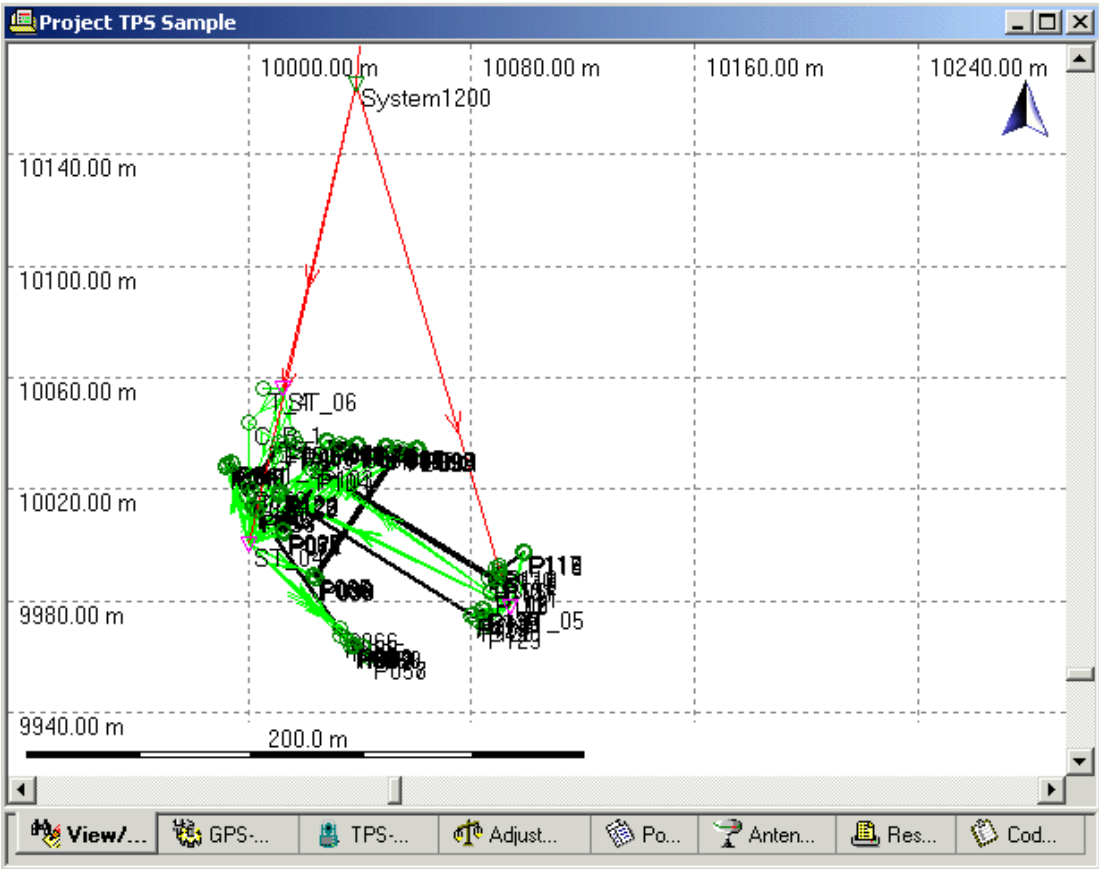

Continue with [TPS Tour III - Lesson 2: Automatically update Set Orientation setups.](#)

TPS Tour III - Lesson 2: Automatically update "Set Orientation" setups

The objectives of this lesson are:

- To prepare and check the settings for an automatic update.
- To import the fifth set of data collected in a job called **JOB_5**. This time the data comes from GPS measurements.
- To reflect upon the use of coordinate systems within an LGO project.
- To automatically update the orientations of the "Set Orientation" setups and all related measurements in **JOB_4**.

After having successfully imported the job **JOB_4** and zoomed the view into the "lower" cluster of points you should see the [following](#) in  **View/ Edit**.

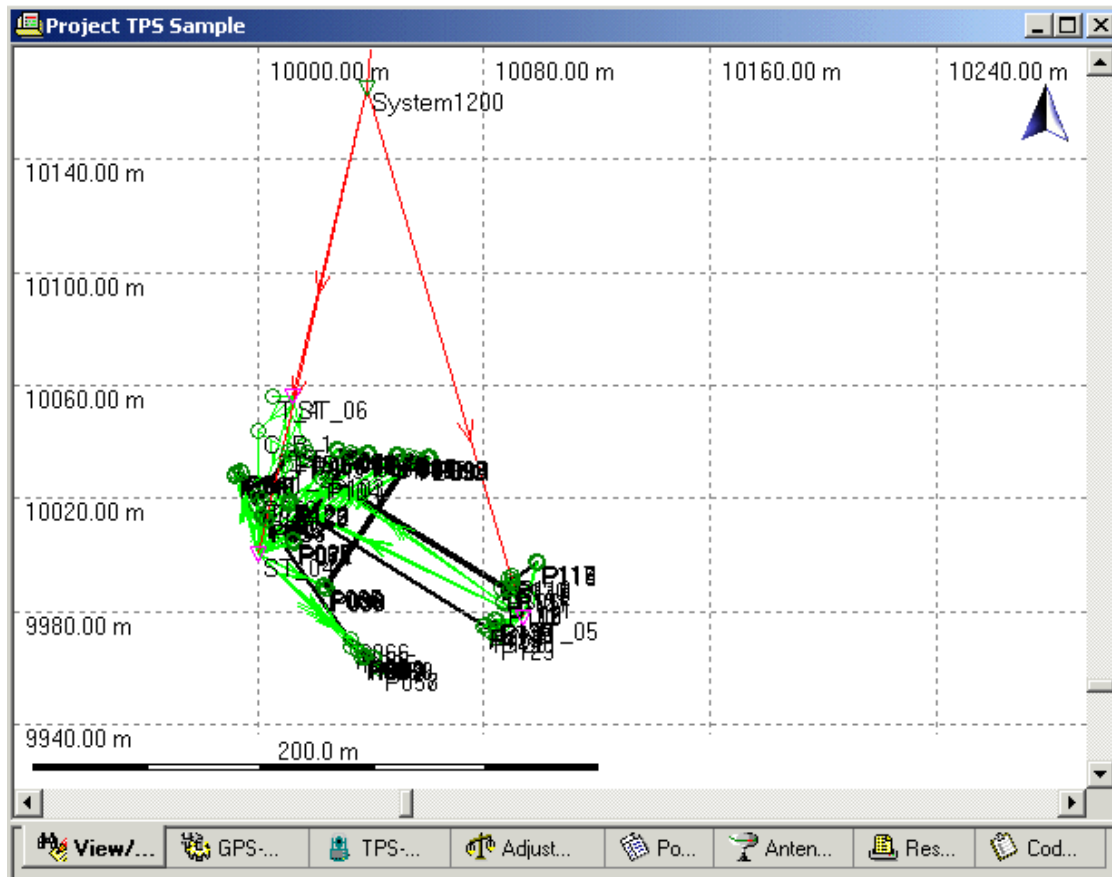

Note: If you prefer to change the color and shading of the black areas, please, refer to the [GPS Tour I - Lesson 2: View and Edit the Real Time data](#). For further information, please, also see the chapter [Lines and Areas](#).

The areas in this Quick Tour have been measured **without** a code in the field. Therefore, you can directly edit the Line/ Area properties. But you have to edit them for each of the black areas separately.

What has been measured in the field is the [following](#) parking lot area:

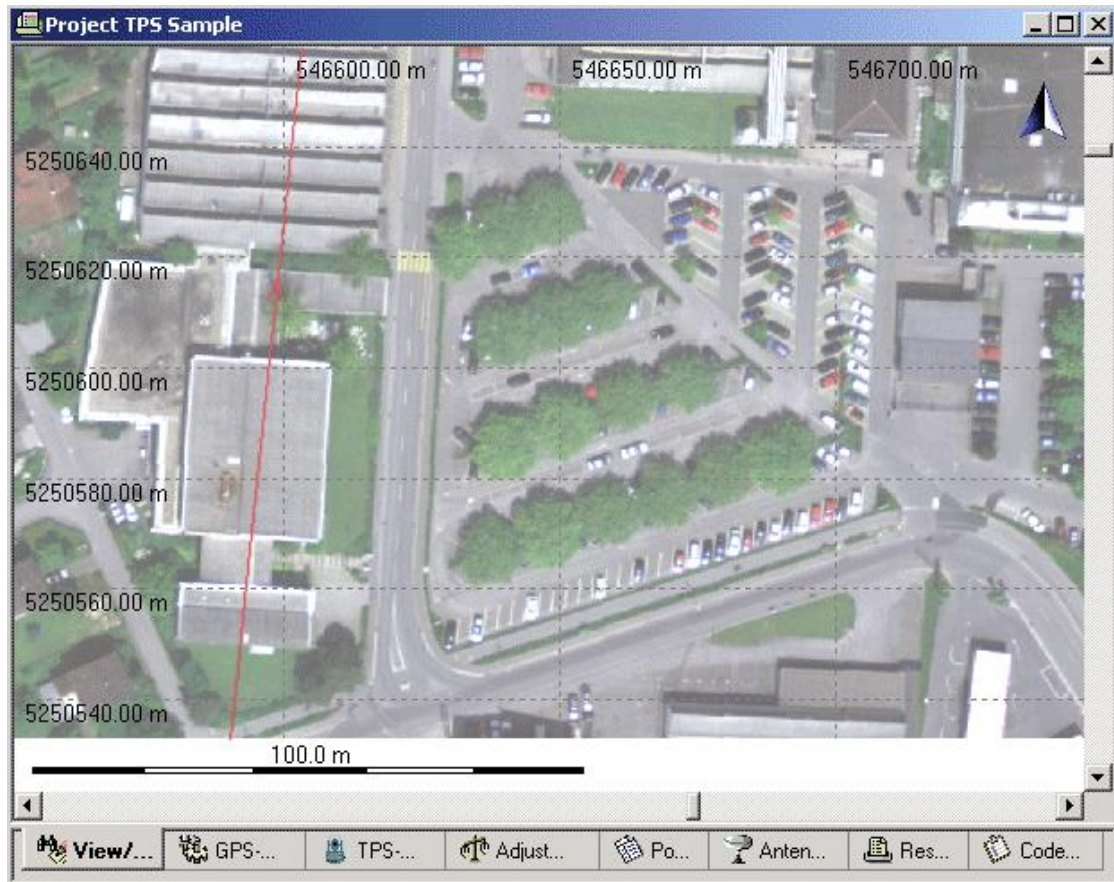

The parking lot has been measured from two different setups (from **ST_04** and **ST_05**). Additionally some trees have been measured from **ST_06**.

What we have to achieve now is "rotating" the three setups such that they fit together as in the given aerial photograph.

To prepare the automatic update of the setups of **JOB_4**:

1. Access the  **TPS-Proc** tab. The setups **ST_04**, **ST_05** and **ST_06** shall be updated and newly oriented.
2. Open the **Setup Properties** dialog for **ST_04** and go to the [Observations](#) page.

Setup Properties

General Observations

Point Id: ST_04

Backsight Point Id: C_B_1

Easting: 10000.0 m

Northing: 10043.8245 m

Height: 499.9218 m

Direction: 0.0 gon

Distance: 43.8246 m

Zenith angle: 99.8658 gon

Azimuth: 0.0 gon Allow automatic update

Orientation: 0.0 gon

Recalculate

OK Cancel

3. Ensure that the **Azimuth** radio button is checked. See that the Azimuth value is 0.0 gon, which is what it was set to in the field.
4. Check the **Allow automatic update** flag. This is needed when you want to use the **automatic** update functionality.

Note: This flag could also have been set in the field. If this flag is set in the field it comes in to LGO automatically during Import. It need not be set manually then for each setup.

5. Leave the dialog with **OK**.
6. Now repeat steps 2. to 5. for **ST_05** and **ST_06**.

Note: You can change the **Allow automatic update** flag for all three setups simultaneously using the context menu of the **Setups** report view.

After that select the GPS job **JOB_5** to be **imported** into the same project *TPS Sample*. **JOB_5** completes the measurements in the parking lot area. The data of all five jobs should fit together in the end.

- Again select  **Import Rawdata** either from the **Import** main menu or from the Toolbar or from the Tools List Bar.

The **Import Raw Data** dialog opens. In this dialog:

- Select **SmartWorx raw data** under **Files of type**.
- Browse to the directory that contains the sample data under **Look in**. By default the sample data for this tutorial will be installed in *C:\Documents and Settings\All Users\Documents\LGO\Sample data\Import\TPS\Job_5*.**
- Select **JOB_5** to be imported.
- Click the **Import** button.

The **Assign** dialog opens. In this dialog:

- In the **General** tab make sure that the project *TPS Sample* is selected for import.
- Click **Assign** and then **Close**. The job data will be assigned to the project *TPS Sample* and you are returned to the **Project window** automatically.

During the Import procedure you will get the 'Averaging limit exceeded' message for one point. Back in the [View/Edit](#) tab you can immediately identify this point as the backsight point **C_B_1** which was measured from all three Smart Station Setups (ST_04, ST_05 and ST_06) and additionally with GPS.

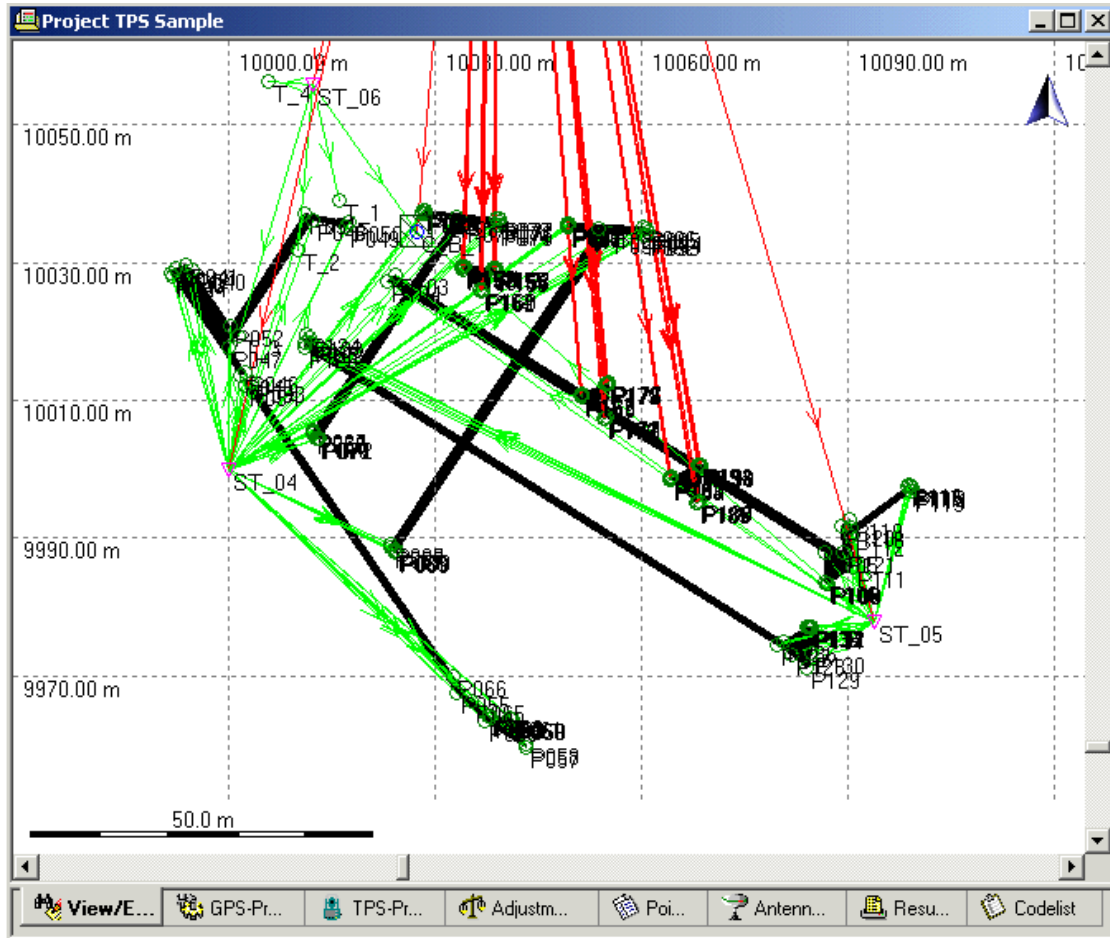

Note that the GPS measurements are displayed in the same area as the TPS measurements coming from JOB_4. This is because the WGS84 coordinates are converted with the coordinate system CAR_PARK_OS that was used with JOB_4 and is now attached to the project.

See the **Point Properties** for C_B_1.

- In the [Point Properties: Mean](#) page you will see that all three coordinate triplets coming from the TPS backsight observations to this point have got the averaging flag (**State**) of *Never*. This is absolutely correct because the "Set Orientation" method by which these coordinates have been determined just delivered preliminary coordinates which differ by several meters from each other.

In contrast, the GPS coordinates are "final". With the help of the preliminary coordinate system they are converted to local grid. In the **Mean** page you can see that the GPS triplet is the only active one which will be further used as the current coordinates for C_B_1. This implies that the GPS coordinates will be the ones used for the automatic update procedure.

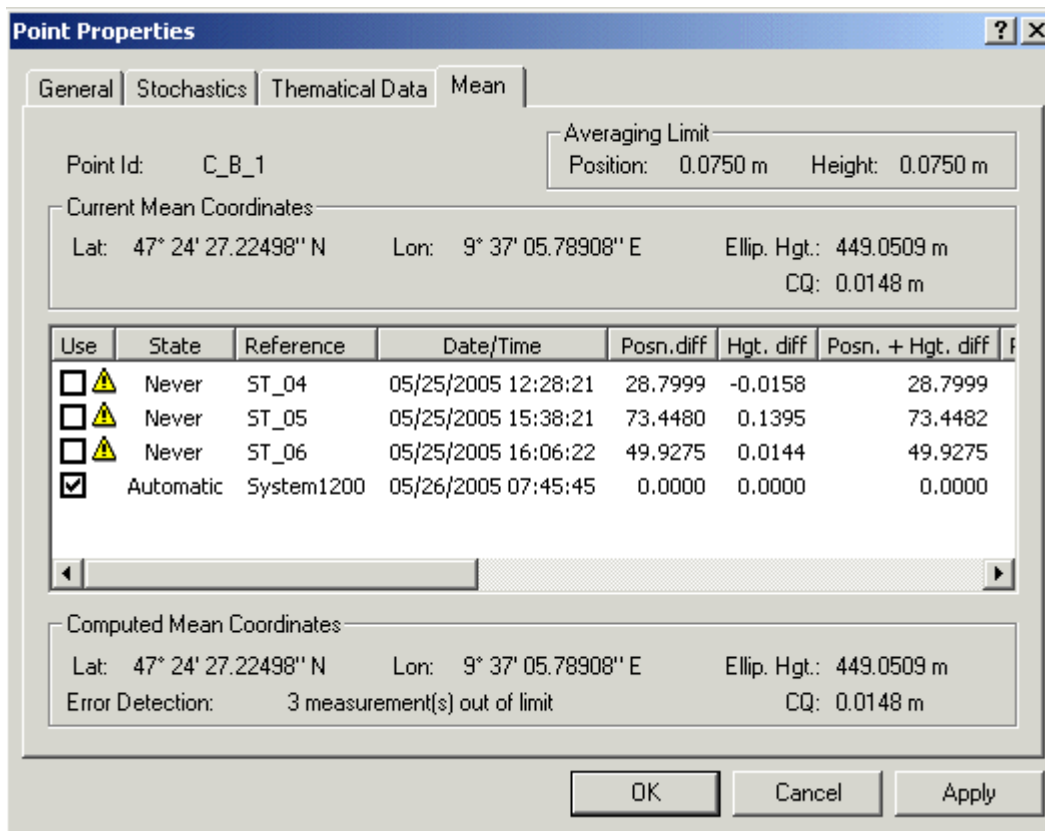

Remember: Setups are **not** automatically updated on import even if they have the **Allow automatic update** flag set in their properties! This means that **ST_04**, **ST_05** and **ST_06** will not be updated automatically on importing **JOB_5**.

After having successfully imported **JOB_5**:

- Choose **Update Setups** from the **TPS-Proc** main menu or from the **TPS-Proc** background menu.

All TPS setups are inspected now for the **Allow automatic update** flag. If the **Allow automatic update** flag is set, then the backsight is updated with the **current** coordinates of the backsight point.

All three setups (**ST_04**, **ST_05** and **ST_06**) are now automatically updated. Additionally, all points measured from these setups are also updated.

For **visualization** of the update access the **View/ Edit** tab again and see that the orientations of all three setups have been updated. The measurements now fit together and the parking lot area now seems to correspond to the area in the aerial photograph.

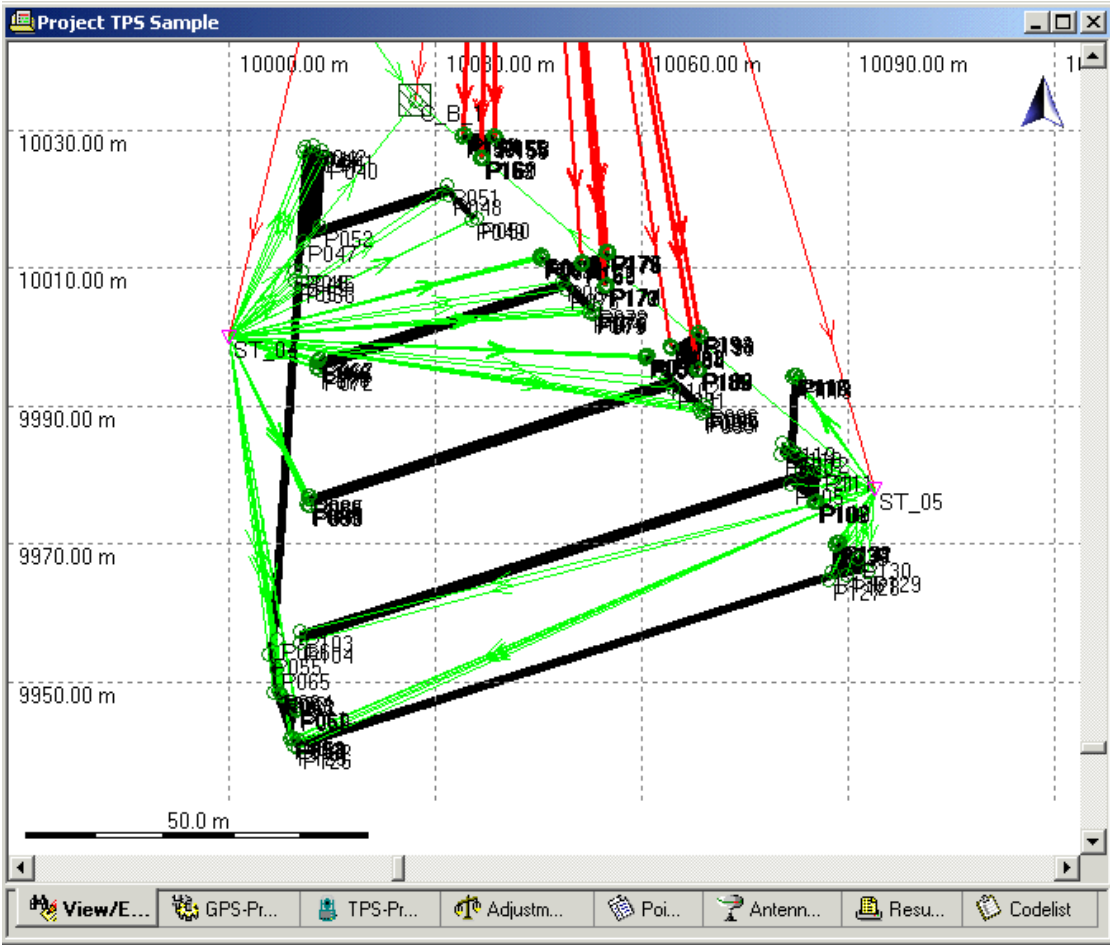

So what remains to be achieved now is "shifting" the data into the area of the first three jobs. Continue with [TPS Tour III - Lesson 3: Exchanging coordinate systems](#).

TPS Tour III - Lesson 3: Exchanging coordinate systems

The objectives of this lesson are:

- To understand the effects of using different coordinate systems with LGO projects.
- To understand the differences between TPS and GPS data.
- To exchange the coordinate system for a subset of TPS data.
- To inspect and understand the effects.

After having successfully updated all setups coming from JOB_4 the data of the parking lot area fits together, i.e. all TPS data fits together and all TPS measurements fit to the GPS measurements, but altogether the data coming from JOB_4 and JOB_5 is still located in a totally different area than the data coming from the first three jobs, although all five jobs have been measured in the same area and the data should be located in the same area!

Remember: Still the just preliminary coordinate system CAR_PARK_OS is attached to the project *TPS Sample*. The TPS data is **stored** as local grid coordinates in this preliminary coordinate system. The GPS coordinates are **converted** from WGS84 to local grid by this preliminary coordinate system. The TPS data coming from the first three jobs is **stored** as local grid coordinates in the *utm32* coordinate system, though.

Thus, what we have to achieve is that all TPS data is stored in the same coordinate system.

Now, you might think that the problem can be solved by attaching the *utm32* coordinate system again to the project. But remember that in contrast to the GPS measurements the TPS measurements are not stored as WGS84 coordinates. Attaching the *utm32* coordinate system instead of the CAR_PARK_OS coordinate system to the project would successfully "move up" the GPS measurements from JOB_5 to the cluster of points coming from the first three jobs, because the WGS84 coordinates of the GPS measurements are then converted to UTM coordinates instead of preliminary local grid coordinates. But the TPS measurements cannot be converted. They are stored as local grid and would stay where they are!

Thus, we have to make use of the [Exchange coordinate system](#) functionality offered by LGO. With this functionality you may exchange the coordinate system for a subset of points that are stored as local grid coordinates.

1. Go to the  **Points** view and select **ST_04**, **ST_05** and **ST_06**.

Alternatively, stay in  **View/ Edit** and select **all** points in the lower cluster by drawing a rectangle around them.

2. From the context menu or the view's main menu select **Exchange coordinate system...**
3. In the [Start](#) page of the **Exchange Coordinate System** wizard the three TPS setups are listed together with all related points that have been measured from these setups.

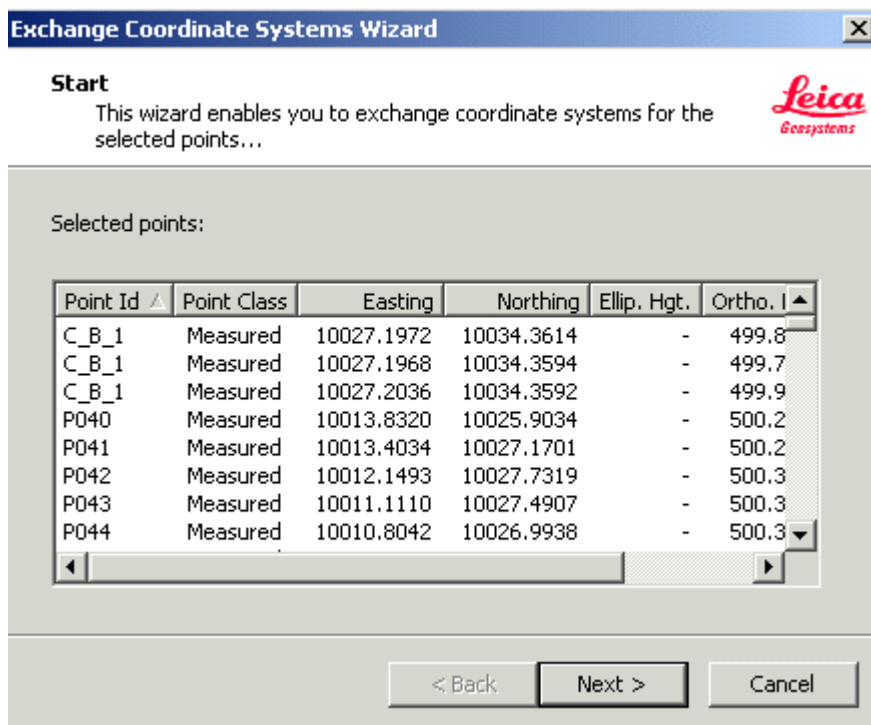

4. Click **Next**.
5. In the [Coordinate System selection](#) page of the wizard see that the preliminary coordinate system CAR_PARK_OS is already selected as the "old" coordinate system.

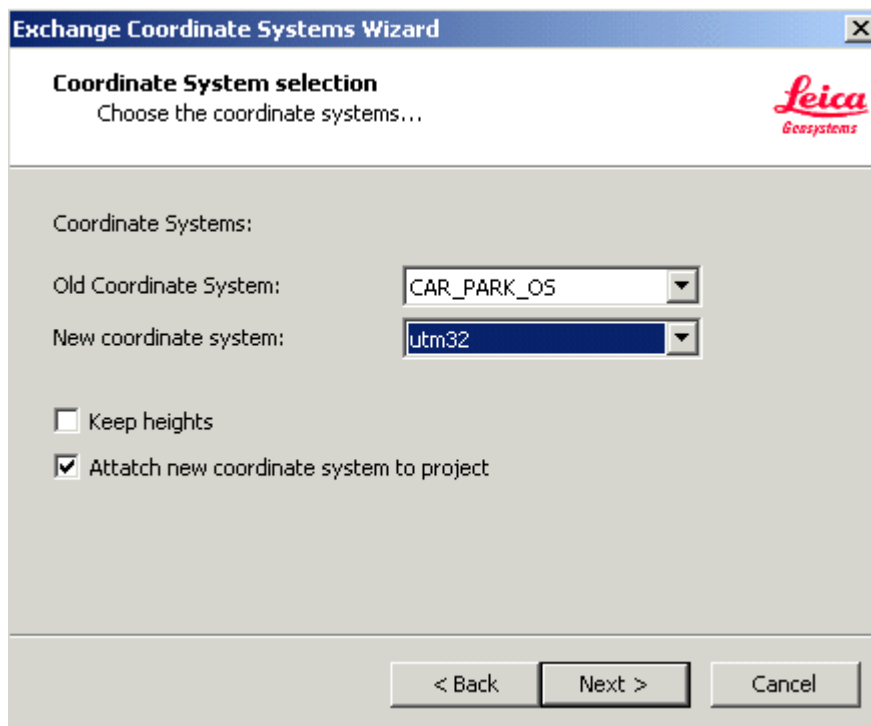

6. Select the **utm32** coordinate system as the "new" coordinate system.
7. Make sure that the checkbox **Attach new coordinate system to project** is ticked.

By this you achieve that the **utm32** coordinate system that has been used with the data coming from the first three jobs is attached to the project *TPS Sample* again. The GPS data coming from JOB_5 will be converted to this "new" coordinate system.

8. Click **Next** to finish the wizard. All selected points are listed again with their new UTM coordinates.
9. Click **Finish** to effectively exchange the coordinate system.

Now return to  [View/Edit](#) to see what you have achieved.

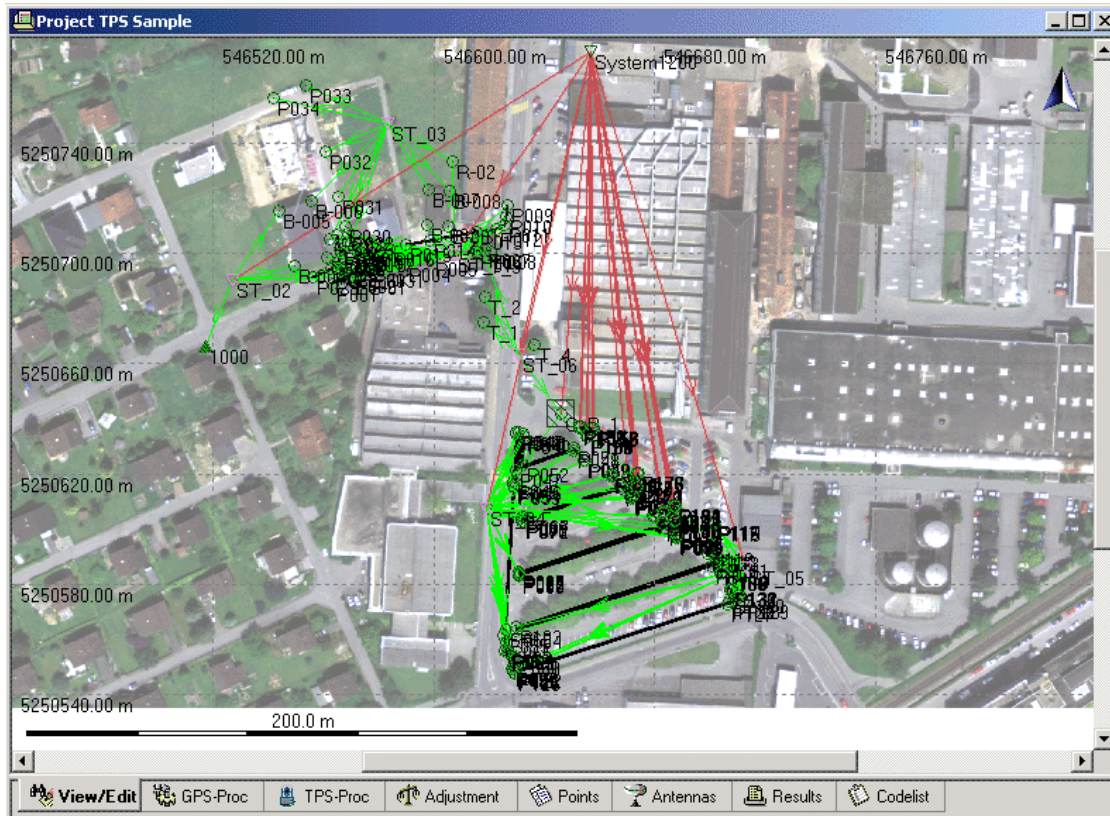

The parking lot area has been "moved up" into the area of the background image. You can see immediately that the data fits. Obviously, all updates on the data of JOB_4 have been performed correctly.

The GPS measurements coming from JOB_5 have been converted to the *utm32* coordinate system. In comparison to the background image you can see the areas that these measurements enclose.

Continue with [TPS Tour III - Lesson 4: Correcting target heights](#).

TPS Tour III - Lesson 4: Correcting target heights

The objectives of this lesson are:

- To correct the target height for the **setup observation** (the backsight) on ST_05.
- To correct the target heights for all **survey observations** on ST_04.

You are certainly surprised that after all measurements should now fit there remains one limit exceeded indicator in  **View/ Edit** on C_B_1.

Have a look into the [Point Properties: Mean](#) page for C_B_1:

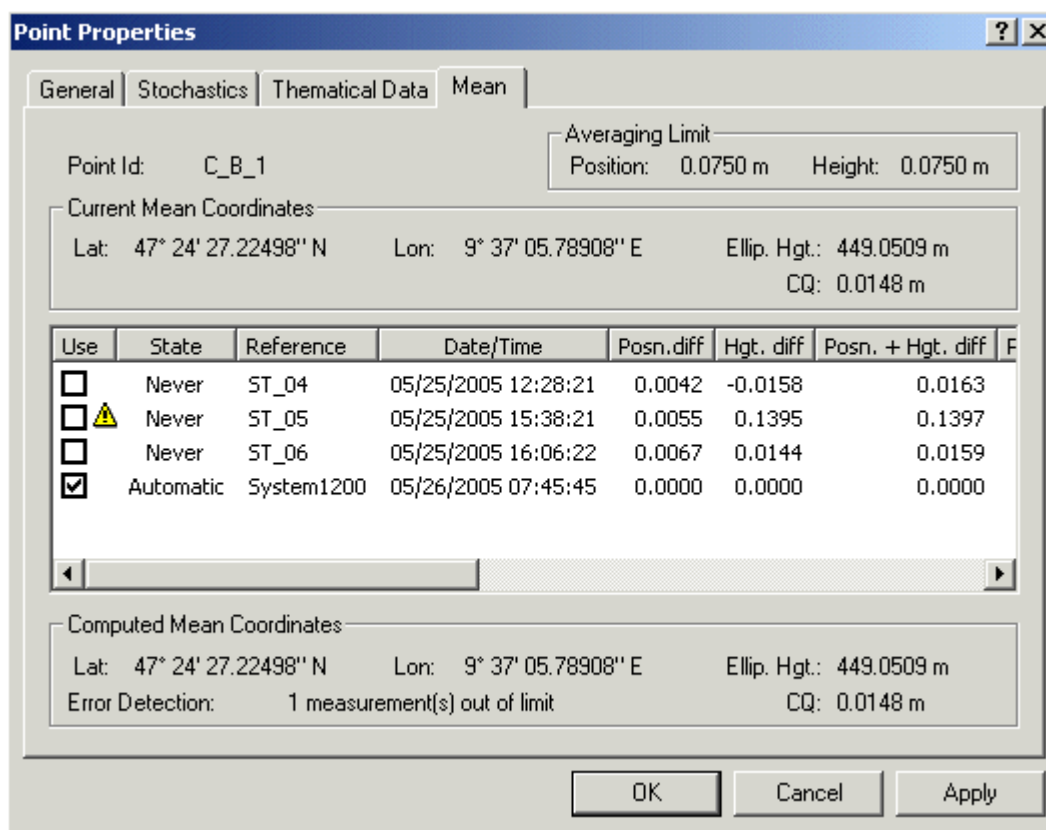

- See that for the position of C_B_1 there is no limit exceeded, but for its height. Obviously, on ST_05 a **wrong target height** was entered on the instrument when measuring the backsight to C_B_1.

Another mistake has cropped in on ST_04. It is not as obvious as the mistake on ST_05. All survey observations made from ST_04 got wrong heights when a wrong target height was entered on the instrument in the field. In position all observation are o.k..

We will see that LGO offers a neat solution to correct all survey observations in one go!

Now, start with correcting the backsight observation on ST_05:

- Go to the  **TPS-Proc** view and open the  **Setup Observations** node for the  **Setup** ST_05 in the [tree view](#).

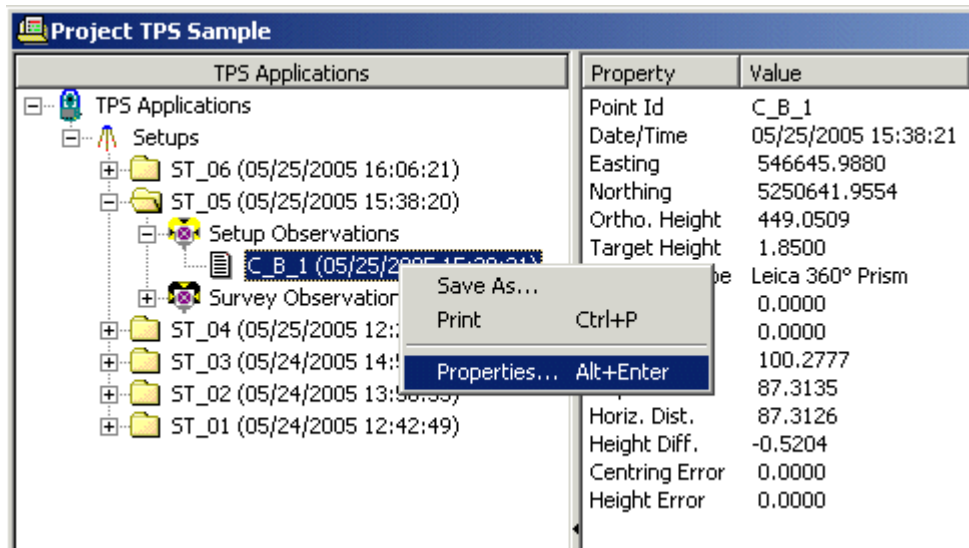

- Right-click on the **Setup Observation** C_B_1 in the tree view and select **Properties...** from the context menu.
- In the **Observations** dialog go to the **Target Hgt.** edit field and change the target height from **1.85m** to **1.75m**.

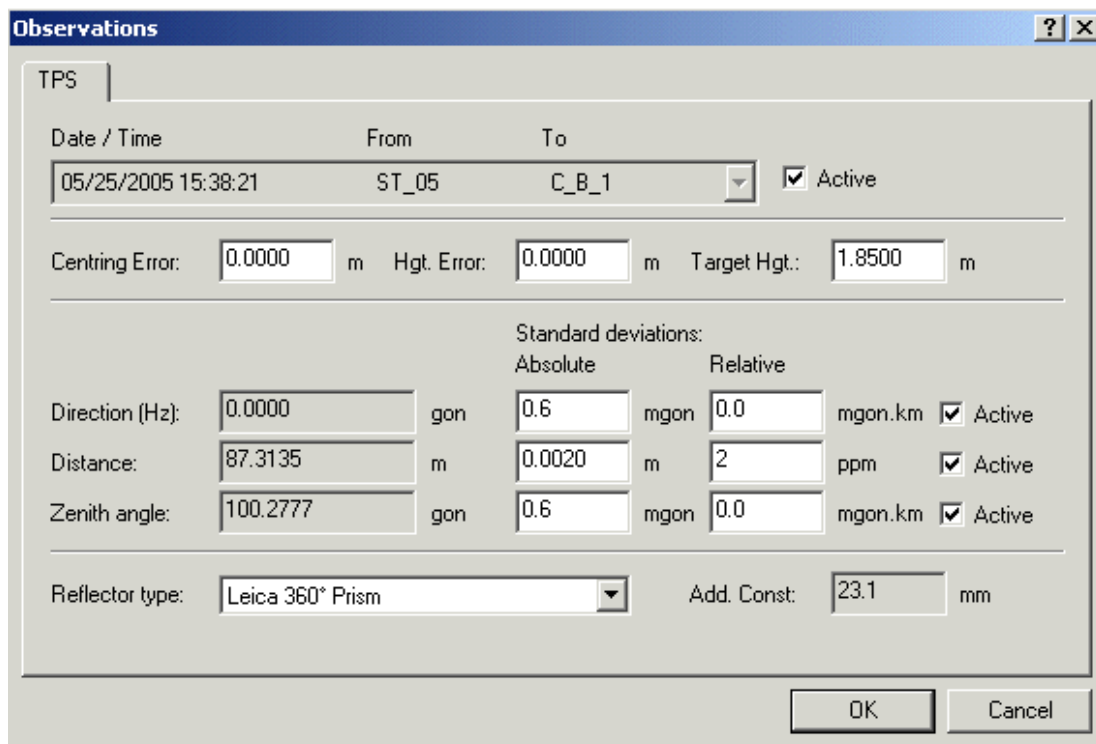

- Leave the dialog with **OK**. The target height for the TPS observation to C_B_1 will be changed. The target coordinates will be changed accordingly. Confirm the Warning message with **Yes**.
- Return to **View/ Edit** and see that the averaging limit exceeded indicator on C_B_1 has disappeared.

Continue with correcting the target height for all survey observations made on ST_04:

- Right-click in the background of the  **View/ Edit** graphical view and select **View Observations...** from the background context menu or from the **View/ Edit** main menu.
- In the [Observations View](#) go to the **From** tree view and select the setup ST_04. On the right-hand side select the **TPS** report view to be displayed.

You will get an overview then on **all** Setup and Survey observations that have been made on ST_04. The **Setup observation** (i.e. the backsight to C_B_1) is o.k. on ST_04. But all **Survey observations** got the wrong target height.

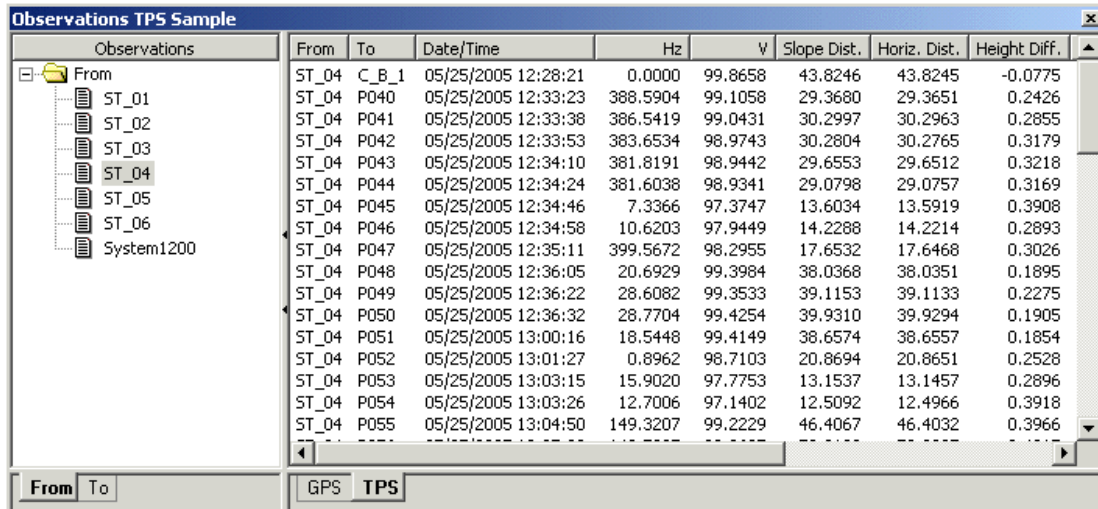

From	To	Date/Time	Hz	V	Slope Dist.	Horiz. Dist.	Height Diff.
ST_04	C_B_1	05/25/2005 12:28:21	0.0000	99.8658	43.8246	43.8245	-0.0775
ST_04	P040	05/25/2005 12:33:23	388.5904	99.1058	29.3680	29.3651	0.2426
ST_04	P041	05/25/2005 12:33:38	386.5419	99.0431	30.2997	30.2963	0.2855
ST_04	P042	05/25/2005 12:33:53	383.6534	98.9743	30.2804	30.2765	0.3179
ST_04	P043	05/25/2005 12:34:10	381.8191	98.9442	29.6553	29.6512	0.3218
ST_04	P044	05/25/2005 12:34:24	381.6038	98.9341	29.0798	29.0757	0.3169
ST_04	P045	05/25/2005 12:34:46	7.3366	97.3747	13.6034	13.5919	0.3908
ST_04	P046	05/25/2005 12:34:58	10.6203	97.9449	14.2288	14.2214	0.2893
ST_04	P047	05/25/2005 12:35:11	399.5672	98.2955	17.6532	17.6468	0.3026
ST_04	P048	05/25/2005 12:36:05	20.6929	99.3984	38.0368	38.0351	0.1895
ST_04	P049	05/25/2005 12:36:22	28.6082	99.3533	39.1153	39.1133	0.2275
ST_04	P050	05/25/2005 12:36:32	28.7704	99.4254	39.9310	39.9294	0.1905
ST_04	P051	05/25/2005 13:00:16	18.5448	99.4149	38.6574	38.6557	0.1854
ST_04	P052	05/25/2005 13:01:27	0.8962	98.7103	20.8694	20.8651	0.2528
ST_04	P053	05/25/2005 13:03:15	15.9020	97.7753	13.1537	13.1457	0.2896
ST_04	P054	05/25/2005 13:03:26	12.7006	97.1402	12.5092	12.4966	0.3918
ST_04	P055	05/25/2005 13:04:50	149.3207	99.2229	46.4067	46.4032	0.3966

- In the [TPS report view](#) select all Survey observations. Right-click into the selection and select **Edit Target Height...** from the context menu.

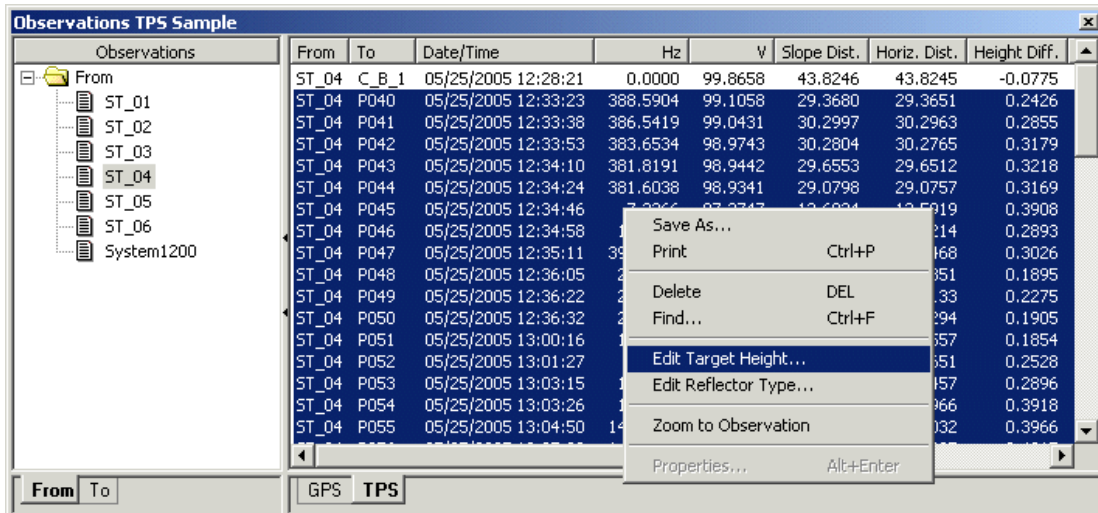

From	To	Date/Time	Hz	V	Slope Dist.	Horiz. Dist.	Height Diff.
ST_04	C_B_1	05/25/2005 12:28:21	0.0000	99.8658	43.8246	43.8245	-0.0775
ST_04	P040	05/25/2005 12:33:23	388.5904	99.1058	29.3680	29.3651	0.2426
ST_04	P041	05/25/2005 12:33:38	386.5419	99.0431	30.2997	30.2963	0.2855
ST_04	P042	05/25/2005 12:33:53	383.6534	98.9743	30.2804	30.2765	0.3179
ST_04	P043	05/25/2005 12:34:10	381.8191	98.9442	29.6553	29.6512	0.3218
ST_04	P044	05/25/2005 12:34:24	381.6038	98.9341	29.0798	29.0757	0.3169
ST_04	P045	05/25/2005 12:34:46	7.3366	97.3747	13.6034	13.5919	0.3908
ST_04	P046	05/25/2005 12:34:58	10.6203	97.9449	14.2288	14.2214	0.2893
ST_04	P047	05/25/2005 12:35:11	399.5672	98.2955	17.6532	17.6468	0.3026
ST_04	P048	05/25/2005 12:36:05	20.6929	99.3984	38.0368	38.0351	0.1895
ST_04	P049	05/25/2005 12:36:22	28.6082	99.3533	39.1153	39.1133	0.2275
ST_04	P050	05/25/2005 12:36:32	28.7704	99.4254	39.9310	39.9294	0.1905
ST_04	P051	05/25/2005 13:00:16	18.5448	99.4149	38.6574	38.6557	0.1854
ST_04	P052	05/25/2005 13:01:27	0.8962	98.7103	20.8694	20.8651	0.2528
ST_04	P053	05/25/2005 13:03:15	15.9020	97.7753	13.1537	13.1457	0.2896
ST_04	P054	05/25/2005 13:03:26	12.7006	97.1402	12.5092	12.4966	0.3918
ST_04	P055	05/25/2005 13:04:50	149.3207	99.2229	46.4067	46.4032	0.3966

- In the **Edit Target Height** dialog change the target height from **1.85m** to **2.15m**.
- Leave the dialog with **OK**. The target heights for all selected survey observations will be changed at once. The target coordinates will be changed accordingly. Confirm the Warning message with **Yes**.

Congratulations! - You have successfully completed Quick Tour III.

TPS Tour IV: Shifting, Rotating and Scaling Traverse data

TPS Tour IV: Shifting, Rotating and Scaling Traverse data

This Quick Tour is a step-by-step tutorial in which you learn how to shift, rotate and scale a set of points so that it fits to the other sets of points in the project *TPS Sample*.

The set of points that shall be transformed (shifted, rotated and scaled) is a traverse. The coordinates of the start point of the traverse come from a Smart Station setup. The **setup method** used on the Start point has been **Set Orientation**, with the azimuth being set to 0.0gon. The same backsight point has also been measured with GPS System 1200.

The end point of the traverse is a known control point. Thus, both points (the first backsight determining the orientation of the traverse and the end point) have "correct" coordinates as well as preliminary coordinates coming from the still "wrongly" oriented traverse.

The objective of this exercise is to transform the traverse such that it fits to the final known coordinates. The aim will be achieved via the **Shift/ Rotate/ Scale** functionality in LGO.

Note: The same data can also be processed by defining a Traverse and calculating the traverse using the *2D Helmert Adjustment Method* after *Control* triplets have been added for the known points. This would typically be the preferred procedure, however, in this Quick Tour we will still use the **Shift/ Rotate/ Scale** functionality.

Start this Quick Tour with importing the traverse data as SmartWorx raw data: [TPS Tour IV - Lesson 1: Importing Traverse data](#).

TPS Tour IV - Lesson 1: Importing Traverse data

The objectives of this lesson are:

- To import another TPS survey job (**JOB_6**) containing the traverse data into the LGO project *TPS Sample*.
- To reflect upon the existing coordinate triplets for the first backsight point of the traverse **C_B_1**: which triplets exist and which are the **current** coordinates of **C_B_1**?

A sixth job **JOB_6** has been measured in the field which shall now be imported into the same LGO project *TPS Sample*. The job has been measured in the same area and the data should fit to the data coming from the first five jobs in the end.

- Select  **Import Raw data** either from the **Import** main menu or from the Toolbar or from the Tools **List Bar**.

The **Import Raw Data** dialog opens. In this dialog:

- Select **SmartWorx raw data** under **Files of type**.
- Browse to the directory that contains the sample data under **Look in**. By default the sample data will be installed in *C:\Documents and Settings\All Users\Documents\LGO\Sample data\Import\TPS\Job_6*. **.
- Select the job **JOB_6** to be imported.
- Click the **Import** button.

The **Assign** dialog opens. In this dialog:

- In the **General** tab make sure that the project *TPS Sample* is selected for import.
- Click **Assign** and then **Close**. The job data will be assigned to the project *TPS Sample* and you are returned to the **Project window** automatically.

During the Import procedure you will get the 'Averaging limit exceeded' message for one point. Back in the  [View/ Edit](#) tab you can immediately identify this point as the first backsight point of the traverse **C_B_1** measured from **ST_04**, **ST_05**, **ST_06**, from the GPS reference **System 1200** and from the first setup in the traverse **ST_07**.

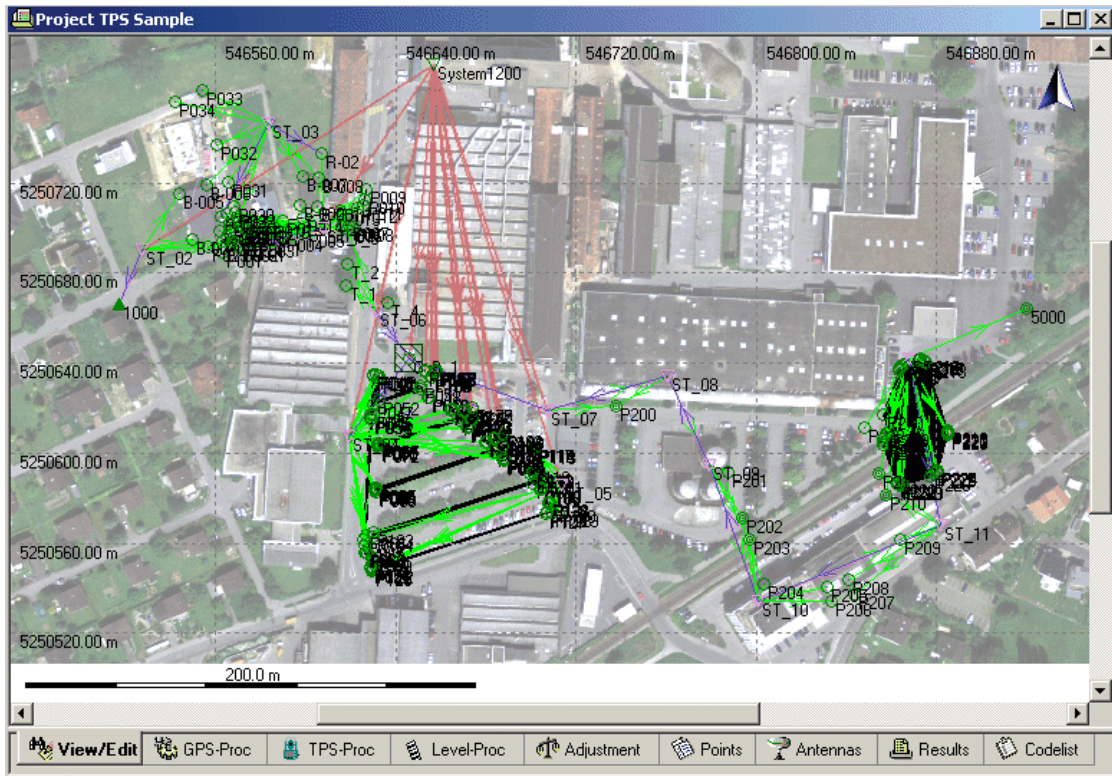

Remember that the measurements from ST_04...ST_06 have already been updated in the previous Quick Tour and fit to the GPS measurement of C_B_1. The averaging flag of the measurements from ST_04...ST_06 is still *Never*, which is perfectly fine.

See the [Point Properties: Mean](#) page for C_B_1 again:

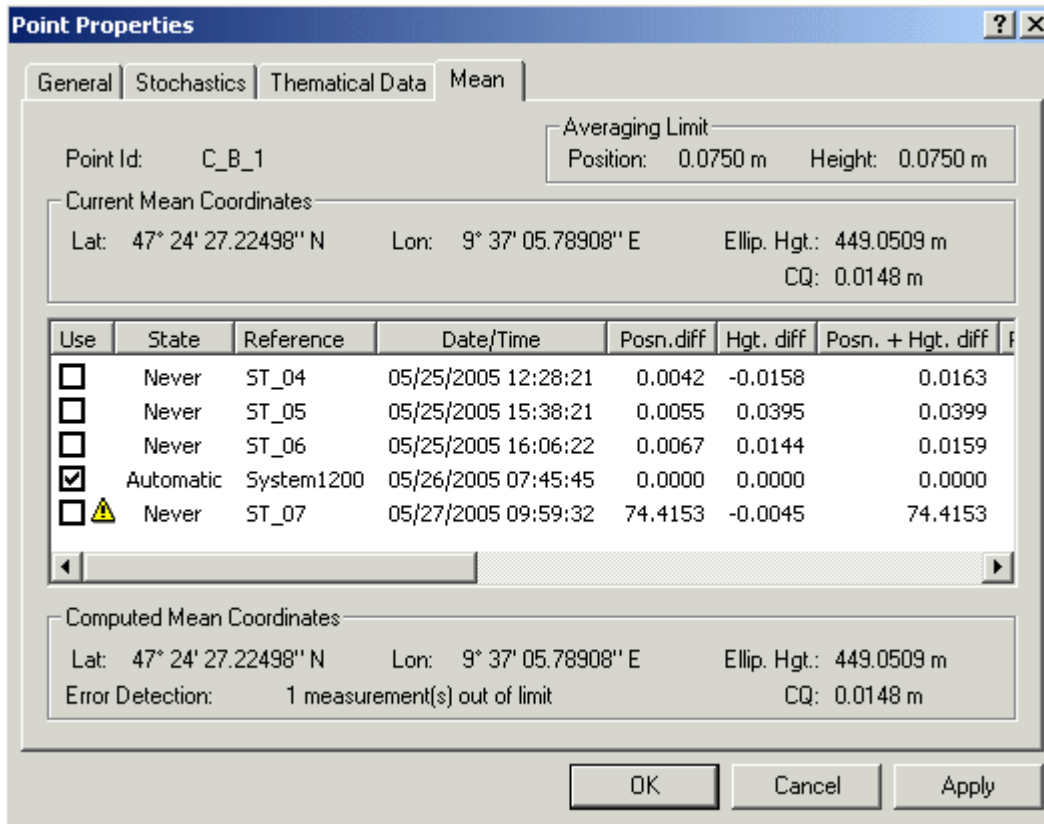

- The averaging flag of the TPS backsight observation coming from **ST_07** is also *Never*, which is absolutely correct because the "Set Orientation" method by which these coordinates have been determined just delivered preliminary coordinates. The measurement has been marked as the outlier () causing the 'limit exceeded' message.

In contrast, the GPS coordinates are "final". In the **Mean** page you can see that the GPS triplet is still the only active one which will be further used as the **current** coordinates for C_B_1.

Please, keep in mind that this implies that the GPS coordinates will be the coordinates which the first TPS backsight of the traverse shall be transformed to in the Shift/ Rotate/ Scale procedure.

Note: In View/ Edit it seems that the observation from **ST_07** to C_B_1 is already correctly oriented. But this is only due to the fact that the view displays C_B_1 in the location of the current coordinates and **not** in the location of the only preliminarily oriented observation coming from ST_07!

Continue with [TPS Tour IV - Lesson 2: Importing control points from ASCII.](#)

TPS Tour IV - Lesson 2: Importing control points from ASCII

The objective of this lesson is:

- To import the "correct" coordinates of the foresight to the known point **5000** from an ASCII file.

Note: This ASCII file also includes control points which will be needed in [TPS Tour V: Processing a Traverse](#).

Now, continue with importing the "correct" coordinates for point 5000 (**5000 CTRL**). Just like the first backsight to C_B_1, the foresight to the point 5000 is just preliminarily oriented. It has inherited the "wrong" orientation from the first backsight to C_B_1.

The known coordinates of **5000 CTRL** are stored in an ASCII file and will be imported into LGO via the [Import ASCII](#) functionality for text files.

- Select  **Import ASCII data** either from the **Import** main menu or from the Tools [List Bar](#).

The **Import ASCII data** dialog opens. In this dialog:

- Select **Text files** under **Files of type**.
- Browse to the directory that contains the sample data under **Look in**. By default the sample data will be installed in *C:\Documents and Settings\All Users\Documents\LGO\Sample data\Import\TPS*. **
- Select the file *fixpoints.txt* to be imported.
- Make sure that **Template: None**, **Coordinate system: Local** and **Height mode: Orthometric** is selected.
- Click the **Import** button.

You will be guided through the **ASCII Import wizard**, which allows you to define the file format. In this exercise the file to be imported is a simple ASCII file containing the local grid coordinates of only one point separated by tabs.

- In Step 1/4 select **Free** format and **Next** to continue.
- In Step 2/4 select **Tab** as the column separator and **Next** to continue.
- In Step 3/4 make sure the **Coordinate Type** is set to *Grid*. Then right-click on the first column and select **Point Id**. In the same way assign **Coordinates Easting**, **Coordinates Northing** and **Orth. Height** to the following columns. Press **Next**.
- In Step 4/4 you can save the import mask as a template for the next time you import an ASCII file. Press **Finish** to proceed to the Assign dialog.
- **Assign** the data to the same project *TPS Sample* and leave the dialog with **Close**. The data will be assigned to the project *TPS Sample* and you are returned to the **Project window** automatically.

The local control point **5000 CTRL** is now stored in the project. It corresponds to the point **5000**, although it is located in a completely different place in  **View/ Edit**. Point **5000** still has preliminary coordinates and shall be transformed to the known coordinates of point **5000 CTRL**.

Continue with [TPS Tour IV - Lesson 3: Shifting, Rotating and Scaling Traverse Data](#).

TPS Tour IV - Lesson 3: Shifting, Rotating and Scaling Traverse Data

The objective of this lesson is:

- To transform (Shift, Rotate and Scale) the traverse such that it fits to the given GPS coordinates of C_B_1 and to the known coordinates of 5000 CTRL.

After having successfully imported **JOB_6** and the known coordinates of point 5000 (**5000 CTRL**) into LGO you should see the [following](#) in  **View/ Edit**.

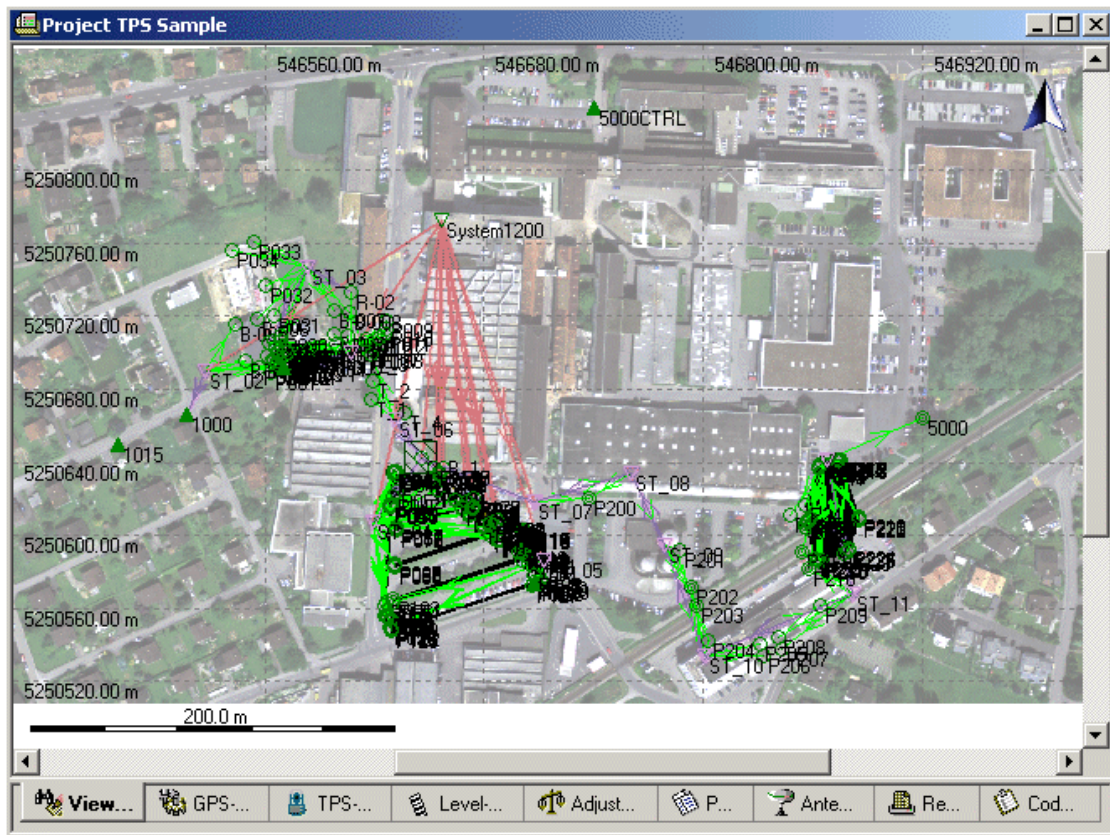

Imagine the following scenario:

The survey crew that measured the traverse did not know the coordinates of C_B_1 in the field. The coordinates of C_B_1 have been measured in a GPS job (JOB_5) by a different crew. Thus, they measured the first backsight to the yet unknown point C_B_1 with a preliminary orientation of 0.0gon using the **Set Orientation** method on the first setup (ST_07). As a consequence the whole traverse is "wrongly" oriented.

The setup point ST_07 got its coordinates from a Smart Station setup. Thus, the coordinates of ST_07 are known and final.

In LGO it has to be achieved now that the traverse be "rotated" (transformed) according to the "right" orientation.

On the last setup in the traverse an observation has been made to point 5000. Like with all observations in the traverse the orientation to point 5000 is just preliminary and the foresight to point 5000 delivered just preliminary coordinates. The known coordinates of point 5000 (5000 CTRL) have been imported from an ASCII file.

The traverse shall be transformed now via the **Shift/ Rotate/ Scale** wizard in LGO. With the Shift/ Rotate/ Scale functionality you may transform a set of **Grid** coordinates into new coordinates using a *Classical 2D Helmert* transformation for the position and a *shift* for the height component.

C_B_1 and point **5000/ 5000 CTRL** serve as the common points for the *2D Helmert* transformation. By matching the preliminary grid coordinates of **C_B_1** coming from **ST_07** with the GPS coordinates of **C_B_1** and the preliminary grid coordinates of **5000** with **5000 CTRL** the transformation parameters will be determined and finally used to transform, i.e. correctly orientate, the entire traverse in one go.

1. Go to the  **Points** view and select **ST_07...ST_12** from the list of points.
2. Right-click into the selection and select **Shift/ Rotate/ Scale...** from the context menu.

Alternatively, select **Shift/ Rotate/ Scale...** from the **Points** main menu.

3. In the [Start](#) page of the wizard all point triplets that will be moved are listed.

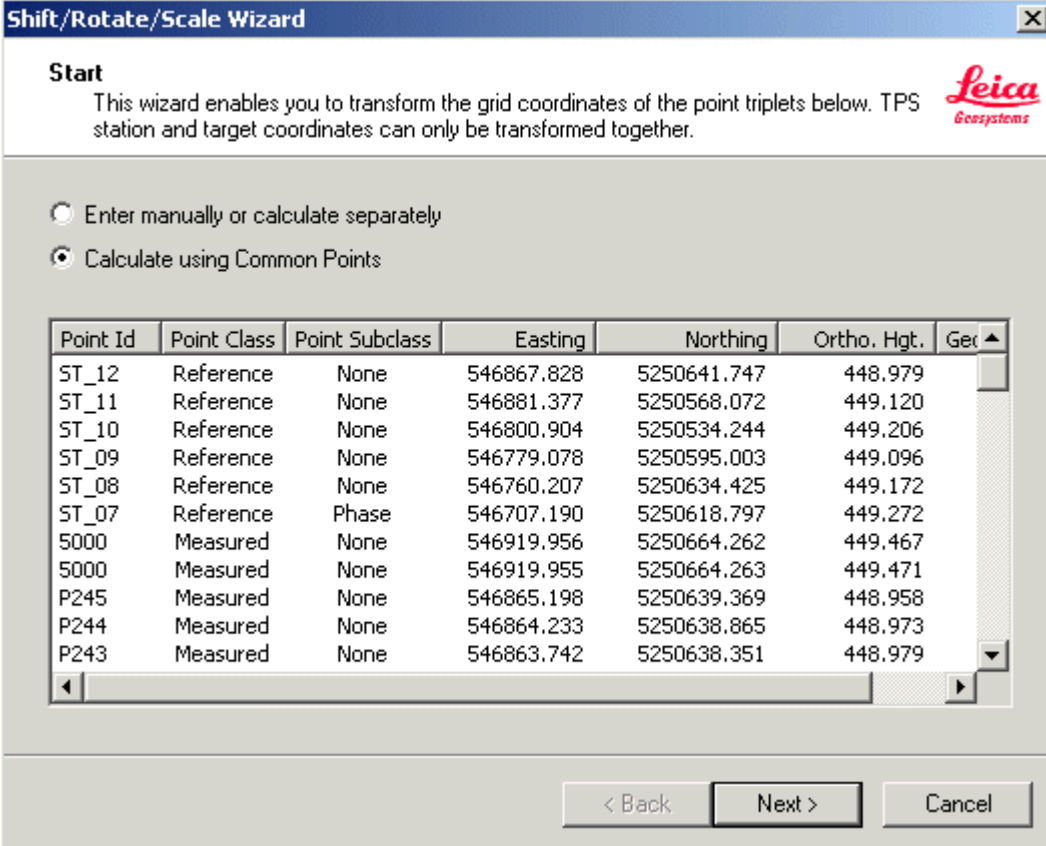

Point Id	Point Class	Point Subclass	Easting	Northing	Ortho. Hgt.	Ge...
ST_12	Reference	None	546867.828	5250641.747	448.979	
ST_11	Reference	None	546881.377	5250568.072	449.120	
ST_10	Reference	None	546800.904	5250534.244	449.206	
ST_09	Reference	None	546779.078	5250595.003	449.096	
ST_08	Reference	None	546760.207	5250634.425	449.172	
ST_07	Reference	Phase	546707.190	5250618.797	449.272	
5000	Measured	None	546919.956	5250664.262	449.467	
5000	Measured	None	546919.955	5250664.263	449.471	
P245	Measured	None	546865.198	5250639.369	448.958	
P244	Measured	None	546864.233	5250638.865	448.973	
P243	Measured	None	546863.742	5250638.351	448.979	

Remember the **selection mechanisms**:

- If you have selected a **Reference** point triplet, then **all** connected measured point triplets will automatically be included in the list. Thus, you will automatically find **all** measured triplets coming from **ST_07...ST_12** in the list, including the measurements to point **5000**.

According to the selection mechanisms you can be sure that **all** points belonging to the traverse (and **none** not belonging to the traverse!) will be transformed when you select the setups **ST_07...ST_12** for the **Shift/ Rotate/ Scale** procedure!

4. Select **Calculate using Common Points** and click **Next** to proceed to the **Common Points** page.

- In the [Common Points](#) page match the **Measured** triplets of the common points: C_B_1 with C_B_1 (GPS point triplet) and 5000 (Averaged) with 5000 CTRL.

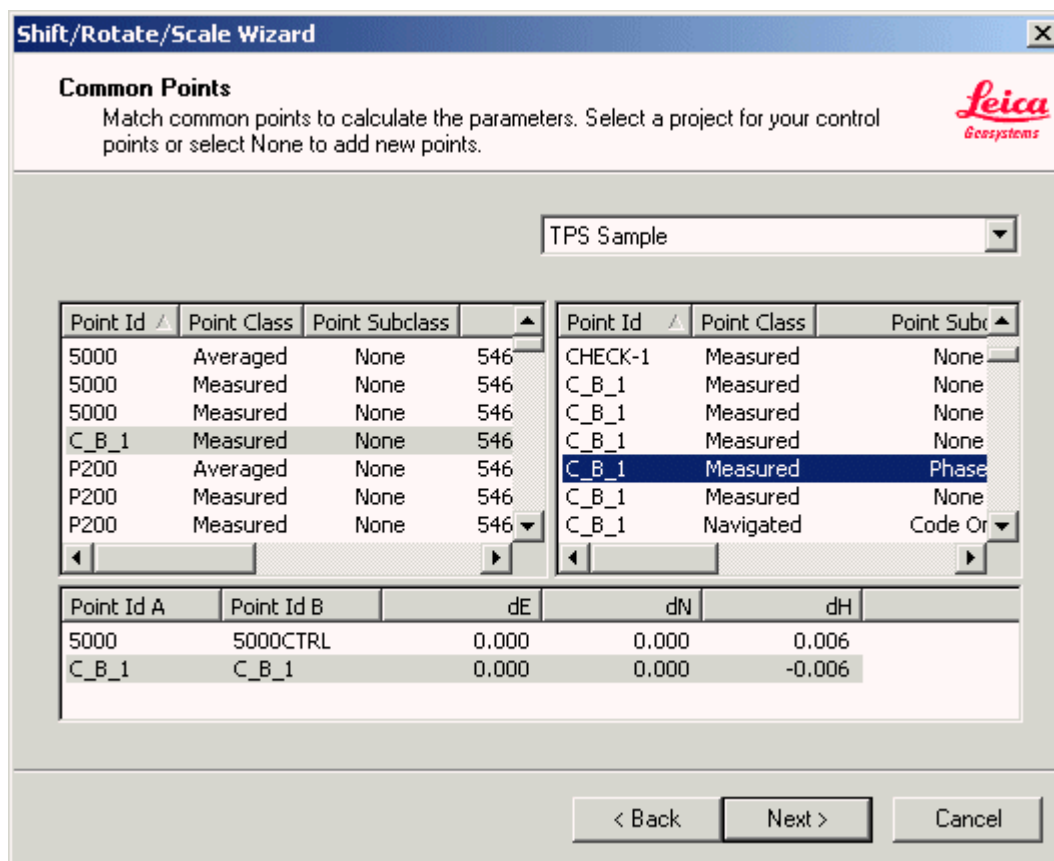

Select the points to be transformed from the top left hand-side view and the control points from the top right hand-side view. Note that the left hand-side view offers only those local grid points for selection which have also been indicated to you in the **Start** page plus the *Averaged* triplets, whereas the right hand-side view offers **all** point triplets which are either stored as local grid or can be **converted** to local grid in the selected project. Thus it contains apart from the traverse points also the GPS point C_B_1 and the control point 5000 CTRL.

To ensure you pick the GPS point triplet for point C_B_1 switch on the column for the point subclass in the right-hand view: Click on the column heading and select **View** and then **Point Subclass** from the context menu. The *Measured* point triplet with subclass **Phase** can then be identified as the GPS derived coordinates.

Note: You need not select a different project for your control points since they are contained in the same project as the points to be transformed.

In the bottom report view the matched points are listed together with the residuals of the transformation.

Note: With only two common points the residuals of the position transformation are zero. You can nevertheless check the transformation by having a look at the scale factor in the next wizard page (in the **Transformation Parameters** page). It has to be very close to 1.0 since the transformation is basically just a rotation!

- Click **Next** to proceed to the **Transformation parameters** page.
- In the [Transformation parameters](#) page you are given an overview on the calculated transformation parameters.

Shift/Rotate/Scale Wizard X

Transformation parameters
Press Back to change or recompute the parameters, press Next to continue.

Leica
Geosystems

Parameter Overview:

dE:	<input type="text" value="-120.598"/>	m
dN:	<input type="text" value="63.663"/>	m
dH:	<input type="text" value="0.002"/>	m
Rz:	<input type="text" value="-76.9725"/>	gon
Easting:	<input type="text" value="546813.572"/>	m
Northing:	<input type="text" value="5250674.251"/>	m
Scale factor:	<input type="text" value="0.9999402667"/>	

Save 2D Transformation:

Name:

Note that the transformation can be stored as any other 2D Helmert transformation if required.

8. Click **Next** to proceed to the **Finish Transformation** page.
9. In the [Finish Transformation](#) page all points to be moved are listed, i.e. all traverse points. All existing triplets are listed together with the transformed coordinates. On pressing **Finish** the existing local grid coordinates will be replaced with the transformed coordinates.

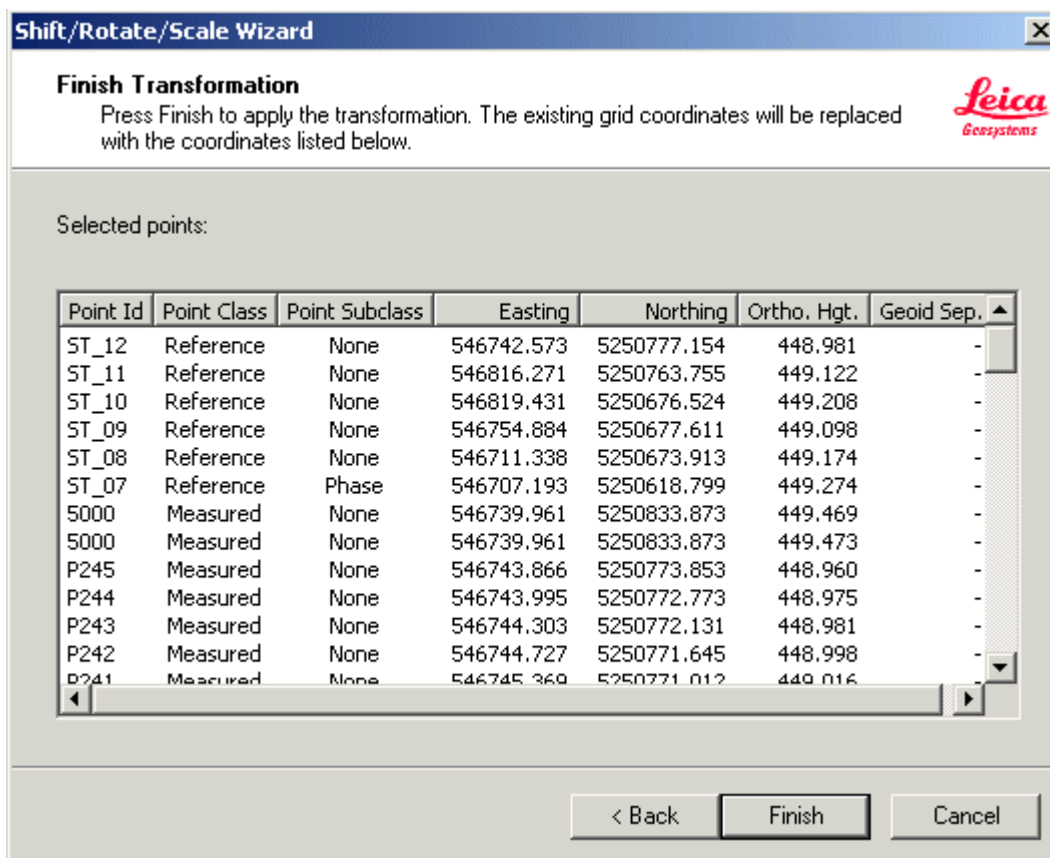

10. Press **Finish** to apply the transformation to the traverse points.

Since all raw observations remain unchanged, the orientation of all TPS setups included in the selection will be updated after finishing the Shift/ Rotate/ Scale wizard.

In the  **View/ Edit** tab the transformation is visualized: [See](#) how the traverse and the connected survey observations now fit together with the background image.

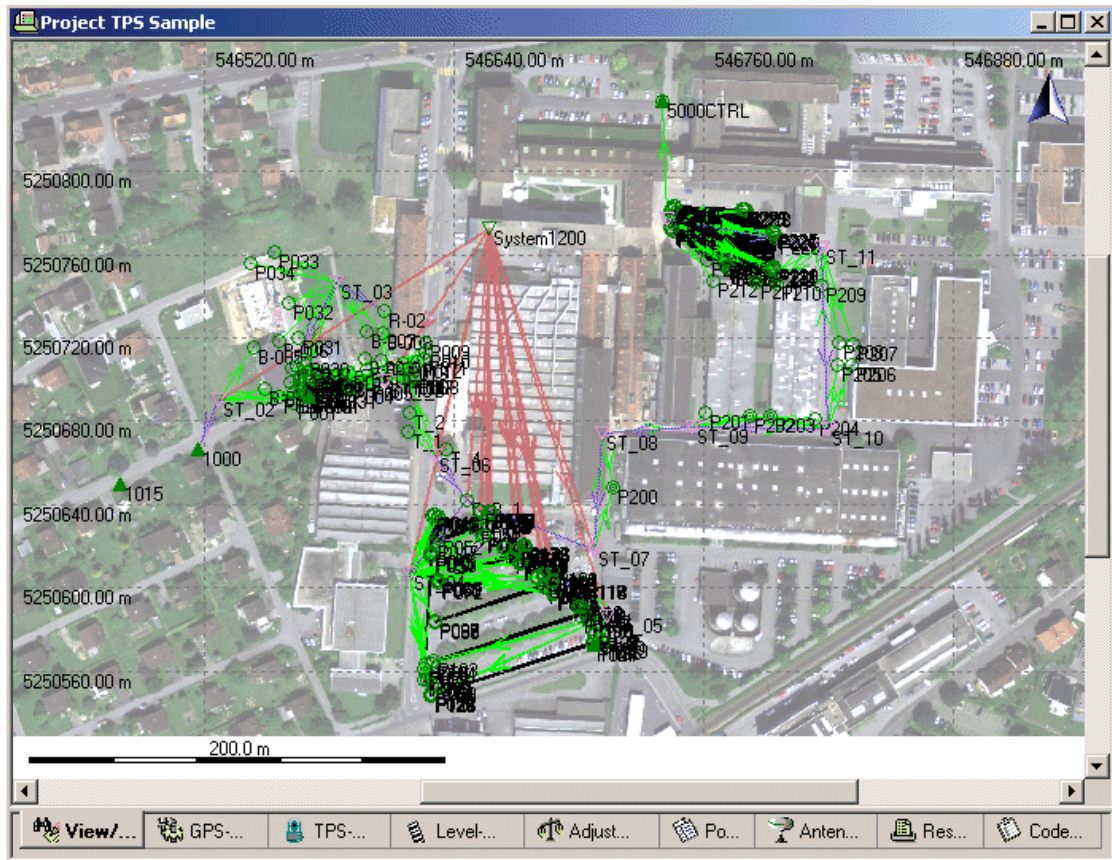

Congratulations! - You have successfully completed Quick Tour IV.

TPS Tour V: Processing a Traverse

TPS Tour V: Processing a Traverse

This Quick Tour is a step-by-step tutorial in which you learn how to create a Traverse from a series of TPS 1200 Setups and how to recalculate the Traverse.

To complete this exercise the **TPS-Processing** option has to be included in your [licence](#).

A job called **Traverse** will be imported into the project *TPS Sample*. The job consists of a series of TPS 1200 setups of which the first one is a 'Set Azimuth' setup and the rest are 'Known Backsight' setups. The measured field data does not contain the information that a traverse has been measured. Just single **Setups** are recognized in LGO.

Thus the tasks which have to be achieved in this Quick Tour are:

- To first **create** the traverse in LGO and
- To **re-calculate** the traverse and to store the results so that all station coordinates and all orientations are updated.
- To update additional setups which have been measured on sideshots of the traverse.

The traverse has been measured in the same area as the data used in the preceding Quick Tours. In comparison with the attached background image you will see that the traverse fits after it has been re-calculated.

Start this Quick Tour with: [TPS Tour V - Lesson 1: Importing the data and creating the Traverse](#).

TPS Tour V - Lesson 1: Importing the data and creating the Traverse

The objectives of this lesson are:

- To import the data collected in a job called **Traverse**.
- To **create** the traverse in LGO from the setups contained in the job *Traverse*.
- To inspect the **View/Edit** view and the **TPS-Proc** view for what has been achieved so far.

Now, start with importing the System 1200 TPS survey job **Traverse** into the project *TPS Sample*.

- Select  **Import Raw data** either from the **Import** main menu or from the Toolbar or from the Tools **List Bar**.

The **Import Raw Data** dialog opens. In this dialog:

- Select **SmartWorxraw data** under **Files of type**.
- Browse to the directory that contains the sample data under **Look in**. By default the sample data for this tutorial will be installed in *C:\Documents and Settings\All Users\Documents\LGO\Sample data\Import\TPS\Traverse*. **
- Select the job **Traverse** to be imported.
- Click the **Import** button.

The **Assign** dialog opens. In this dialog:

- In the **General** tab make sure that the project *TPS Sample* is selected for import.
- Click **Assign** and then **Close**. The job data will be assigned to the project *TPS Sample* and you are returned to the **Project window** automatically.

Note:

- The *Control* points (i.e. the first backsight point in the traverse (1004), the last setup point in the traverse (1015), the last foresight in the traverse (1016) and the checkpoint 1012) needed for re-calculating the traverse in the next lesson have already been imported in [TPS Tour IV - Lesson 2: Importing control points from ASCII](#).

If you **zoom into** the data details in  **View/ Edit** directly after **Import** you will see that the traverse does not yet fit. It seems that [street details](#) and a building (P548...P551) that have been measured as sideshots have to be rotated to the left to fit to the background image.

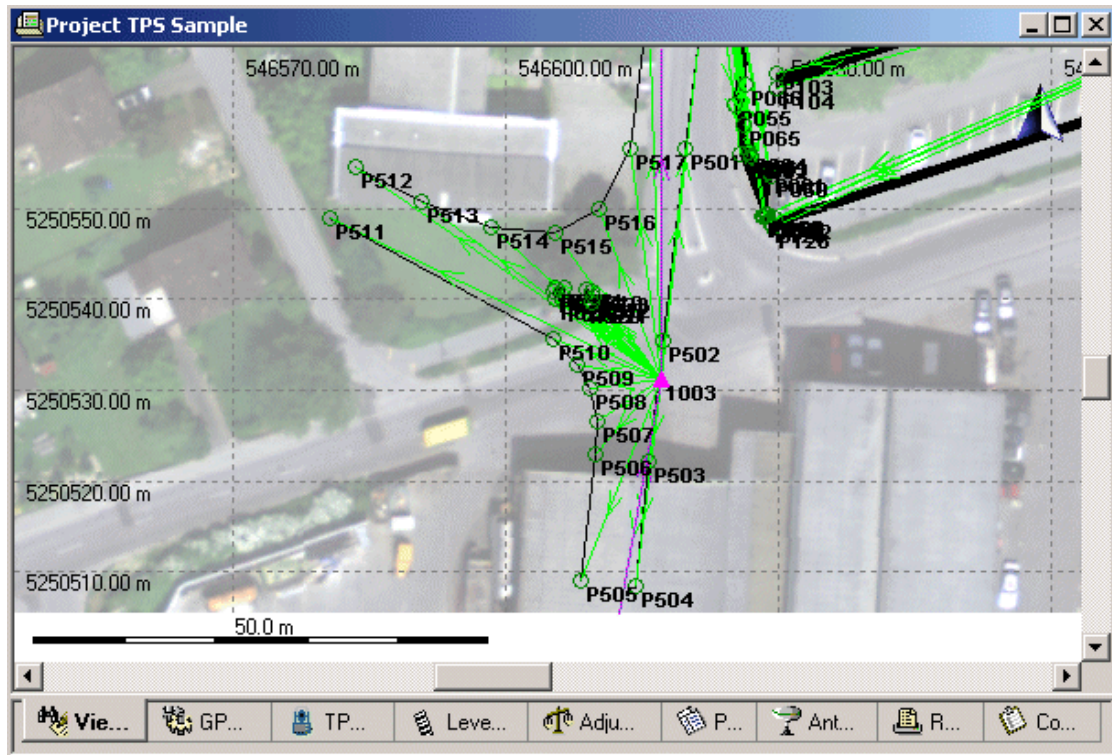

In the **TPS-Proc** view click onto the **Setups** node and you will see that the reason for this is that the first setup in the traverse **1003** has been measured as a **Set Orientation** Setup with the **Azimuth** being preliminarily set to **0.0gon**. The following setups (1005, 1006, 1007, 1009, 1011, 1015) have been measured as 'Known Backsight' Setups with the effect that the whole traverse is geometrically correct and fits in itself but not into its surroundings because the initial orientation is still 'wrong'.

The traverse has to be re-calculated in LGO to finally fit. To be able to do so it has to be **created** first.



To create a new traverse in LGO:

- In the **TPS-Proc** tree-view right-click onto the **Traverses** node and select **New Traverse...** from the context menu.

In the **New Traverse** dialog:

1. Enter a **Traverse Id**, e.g. *Traverse*.
2. From the right-hand report view select the first setup in the traverse. i.e. point **1003**. Press the  button to add the setup to the traverse which will subsequently be build up in the left-hand view.

The right-hand view changes: from now on only those setup points which have a **Setup Observation** back to the previous traverse point will be offered to you for selection. Point 1005 is the only point which has a Setup Observation back to point 1003. Thus it must be the next setup in the traverse. It is automatically selected.

3. Press the  button to add setup **1005** to the traverse.
4. Press the  button two more times to first add setup **1006** and then setup **1007** to the traverse.

After point 1007 has been selected two setup points (1008 and 1009) are recognized. 1008 was actually

a sideshot which turned into a setup when the instrument was set up on 1008 to measure further sideshots.

The next setup in the traverse is point 1009.

5. **Select** point 1009 in the right-hand view and press the  button to add setup **1009** to the traverse.



On 1009 again two setup points (1010 **and** 1011) are recognized but only one of them is the next setup in the traverse.

6. **Select** point 1011 in the right-hand view and press the  button to add setup **1011** to the traverse.

7. Press the  button to add the setup **1015** to the traverse.

Only one observation (to the *Control* point 1016) has been made on 1015 to finish the traverse. Thus 1016 is selected automatically as the final foresight point.

8. Press **OK** to create the traverse. It will be added to the  **Traverses** node in the **TPS-Proc** tree-view.

Now, open the  **Traverses** node and click on the newly created  **Traverse**. On the right-hand side of the **TPS-proc** view the **Traverse View** opens with a booking sheet in the upper part and a graphical representation of the traverse in the lower part.

In the graphical view you can clearly [see](#) the first and the last setup points in the traverse (**1003** and **1015**) as well as the first backsight and the last foresight point (**1004** and **1016**). All four points have *Control* triplets which are needed for **re-calculating** the traverse.

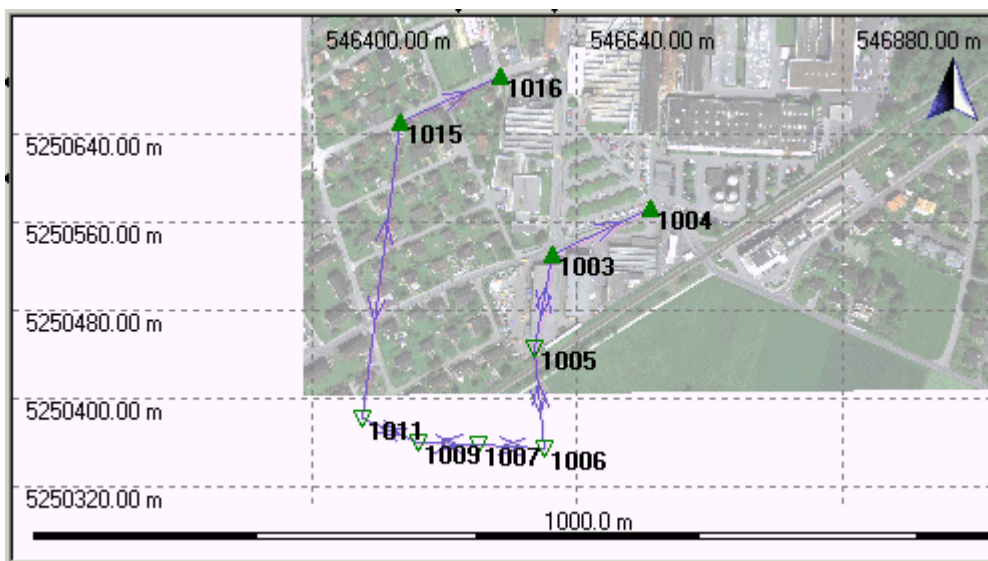

Continue with [TPS Tour V - Lesson 2: Processing the Traverse](#).



TPS Tour V - Lesson 2: Processing the Traverse

The objectives of this lesson are:

- To **re-calculate** the traverse.
- To inspect the result and understand the need for **updating** two **References** and two **Setups**.
- To **update** the **References** 1008 and 1010.
- To change the **Allow automatic update** flag for 1008 and 1010.
- To **update** the **Setups** 1008 and 1010.

After having successfully created the traverse it has to be re-calculated so that the setups contained in the traverse get their final coordinates and orientations.

To re-calculate the traverse:

- In the  **TPS-Proc** tree-view right-click onto the  **Traverse** folder and select **Properties...** from the context menu.

In the **Traverse Properties** dialog:

1. In the **General** page press the **Recalculate** button. For all setups in the traverse the final orientation and final coordinates are calculated.

The angular misclosure and the coordinate misclosures are listed to indicate how well the traverse fits to the *Control* coordinates.

2. Go to the **Stations** page.

Here the newly computed *Reference* coordinates for all setups included in the traverse are listed together with their final orientations.

3. Go to the **Check Points** page.

Here the newly computed *Measured* coordinates of the check point 1012 are listed together with the resulting differences to the given *Control* coordinates. The smaller these differences are the better the traverse fits.

4. Leave the dialog with **OK** to accept the computation results.
5. The **TPS Processing Guide** dialog opens. This dialog allows to automatically update the setups on two stations (1008 and 1010) for which new coordinates become available. While it is normally recommended (and a lot easier) to accept this update, we will perform the necessary updates manually. Therefore press **Cancel**.

Note:

- The **Traverse-processing Parameters** may be changed before re-calculating the traverse. For this exercise the **Default** values are taken.

After having successfully re-calculated the traverse open the **Traverse View** to inspect the results. In the [graphical view](#) you can immediately see the effects of the re-computation.

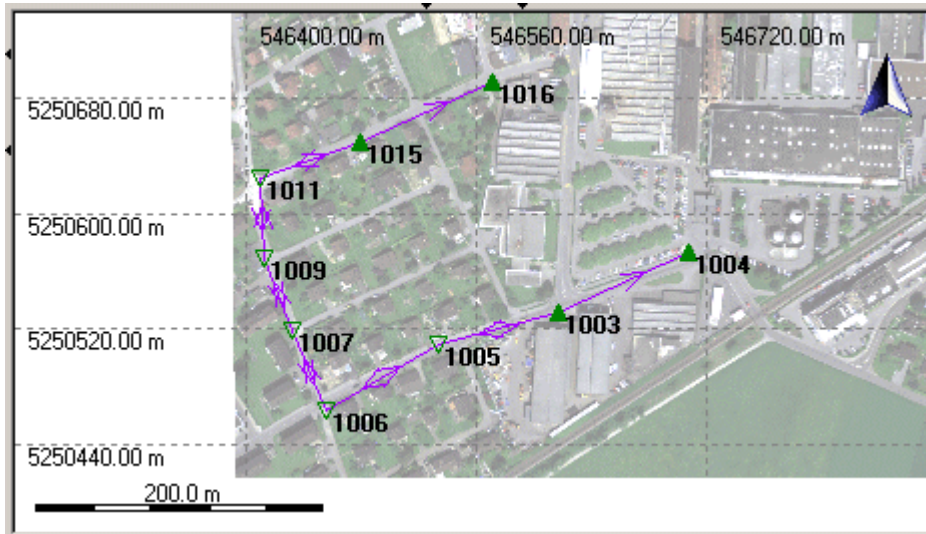

Now, inspect the effects of the re-calculation in  **View/ Edit**.

You will see that the measured [street details](#) perfectly fit to the background image now. When the traverse was re-calculated all sideshots that have been taken on the setups 1003 and 1006 were updated, too. In the end not only the traverse points fit but also all sideshots.

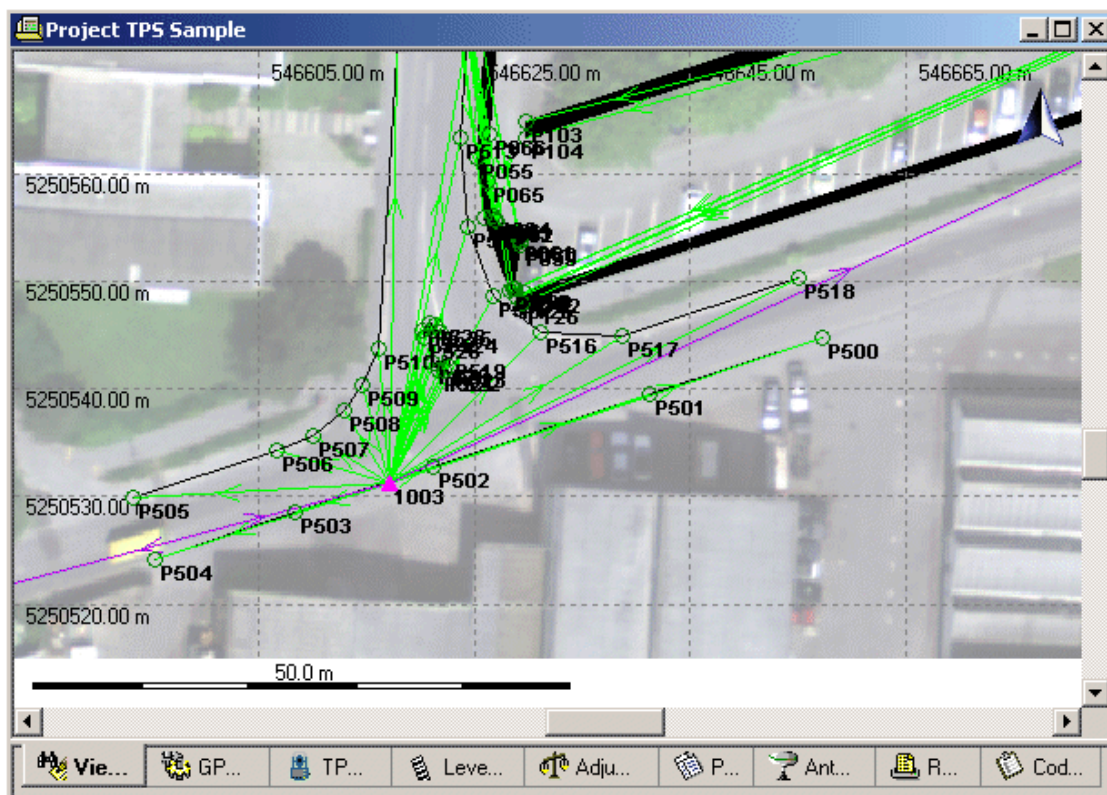

On two of these sideshots (on 1008 and 1010) setups have been measured independently of the traverse. These setups served for measuring the building points P548...P551. If you have a closer look you will see that the building points still do not fit.

The reason is that setups which have been measured on sideshot points of the traverse are **not** automatically updated when the traverse is re-calculated. Such *Reference* triplets have to be **updated manually**:



1. Select Point **1008** and Point **1010** and select **Update Reference triplets...** from the background context menu.
2. In the **Update Reference triplets** dialog the *Measured* triplets have to be selected. The *Measured* triplets have been re-calculated with the traverse as sideshots and their coordinates are correct.

Since no other triplets exist for point 1008 and 1010 the *Measured* triplets will be selected automatically.

On pressing **OK** the existing *Reference* coordinates will be **replaced** with the *Measured* coordinates, i.e. the new *Reference* coordinates will be the same as the *Measured* coordinates.

3. Leave the dialog with **OK**.

Now we have updated the *Reference* coordinates of the Setups **1008** and **1010** but not so far their orientation. Just like the coordinates of these setups have not been updated with recalculating the traverse their orientations haven't been updated either. To achieve this we have to **update the Setups**:

1. Return to the  **TPS-Proc** view and open the **Setups** report view by clicking onto the  **Setups** node in the tree-view.
2. Have a closer look at the **Allow autom. update** column and see that for the Setups 1008 and 1010 this flag is set to 'No'.
3. Change the 'Allow automatic update' flag to 'Yes'. **Select** both setups in the TPS-Proc report view and right-click into the selection. From the context menu select [Allow automatic update](#). See how the flag changes to 'Yes'.

TPS Applications	Point Id ▲	Allow autom. update	Method	Easting	N
TPS Applications	1003	Yes	Set Azimuth	546617.137	52505
Setups	1005	No	Known Backsight	546533.215	52505
Traverses	1006	No	Known Backsight	546455.454	52504
	1007	No	Known Backsight	546432.823	52505
	1008	Yes	Known Backsight	546478.888	52505
	1009	No	Known Backsight	546478.888	52505
	1010	Yes	Known Backsight	546478.888	52505
	1011	No	Known Backsight	546478.888	52506
	1015	No	Known Backsight	546478.888	52506
	ST_01	No	Known Backsight	546478.888	52506
	ST_02	No	Known Backsight	546478.888	52506
	ST_03	No	Known Backsight	546478.888	52507
	ST_04	Yes	Known Backsight	546478.888	52506
	ST_05	Yes	Known Backsight	546478.888	52505
	ST_06	Yes	Known Backsight	546478.888	52506
	ST_07	No	Known Backsight	546478.888	52506
			Set Azimuth	546707.194	52506

4. Now, make use of the **Update Setups** functionality. From the **TPS-Proc** main menu select **Update Setups**.

The orientation on 1008 and on 1010 will be re-calculated. When you return to **View/Edit** you will [see](#) that the building points have 'moved into place' now. The exceeded averaging limits on 1007 and 1009 have also disappeared. Finally everything fits!

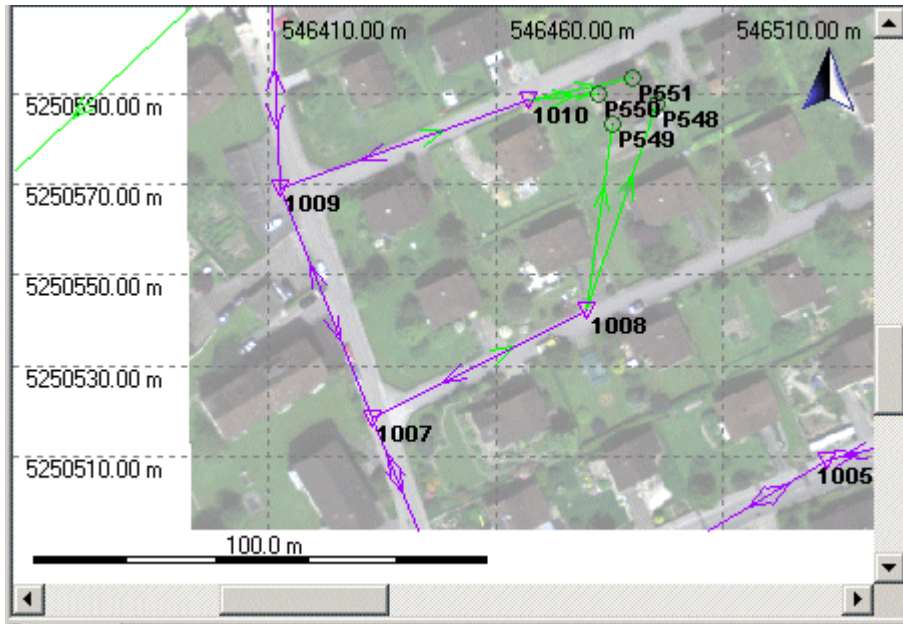

Remember: Updating the Reference triplets and re-calculating the setups could have been done automatically by using the [TPS Processing Guide](#) when storing the Traverse results.

Congratulations! - You have successfully completed Quick Tour V.

TPS Tour VI: Post-Processing SmartStation Setups

TPS Tour VI: Post-Processing SmartStation Setups

This Quick Tour is a step-by-step tutorial in which you learn how to post-process data measured on SmartStation setups and how to perform the necessary updates.

To complete this exercise the **GPS-Processing** and the **TPS-Processing** options have to be included in your [licence](#).

Two jobs have been collected: One GPS Reference job called **tutorial-ref** and one SmartStation job called **S.Stat_RawData**. The GPS job contains the raw data logged on the GPS reference. The SmartStation job contains two setups measured with a SmartStation. Both setups use each other mutually as backsight points. GPS raw data has been logged on the SmartStation setups as well.

- Both jobs shall be imported in to LGO and the raw data shall be post-processed in the first lesson to receive the accurate Setup coordinates.
- In a second lesson the SmartStation setups have to be updated so that the Reference coordinates are corrected as well as the preliminary orientation.

The points have been measured in the same area as the data used in the preceding Quick Tours. In comparison with the attached background image you will see that the measurements fit after the necessary updates have been made.

Start this Quick Tour with: [TPS Tour VI - Lesson 1: Importing and post-processing the SmartStation data](#).

TPS Tour VI - Lesson 1: Importing and post-processing the SmartStation data

The objectives of this lesson are:

- To import the TPS data collected with a SmartStation in the job **S.Stat_RawData** and the raw data collected on the GPS reference station in the job **tutorial-ref**.
- To **post-process** the SmartStation setups in LGO.

Now, start with importing the System 1200 GPS Reference job **tutorial-ref** and the System 1200 TPS job **S.Stat_RawData** into the project *TPS Sample*.

- Select  **Import Raw data** either from the **Import** main menu or from the Toolbar or from the Tools **List Bar**.

The **Import Raw Data** dialog opens. In this dialog:

- Select **SmartWorx raw data** under **Files of type**.
- Browse to the directory that contains the sample data under **Look in**. By default the sample data for this tutorial will be installed in *C:\Documents and Settings\All Users\Documents\LGO\Sample data\Import\TPS\SmartStation*.**
- Check **Include subfolders**. Both System 1200 jobs contained in the selected folder will be imported in one run.
- Click the **Import** button.

The **Assign** dialog opens. In this dialog:

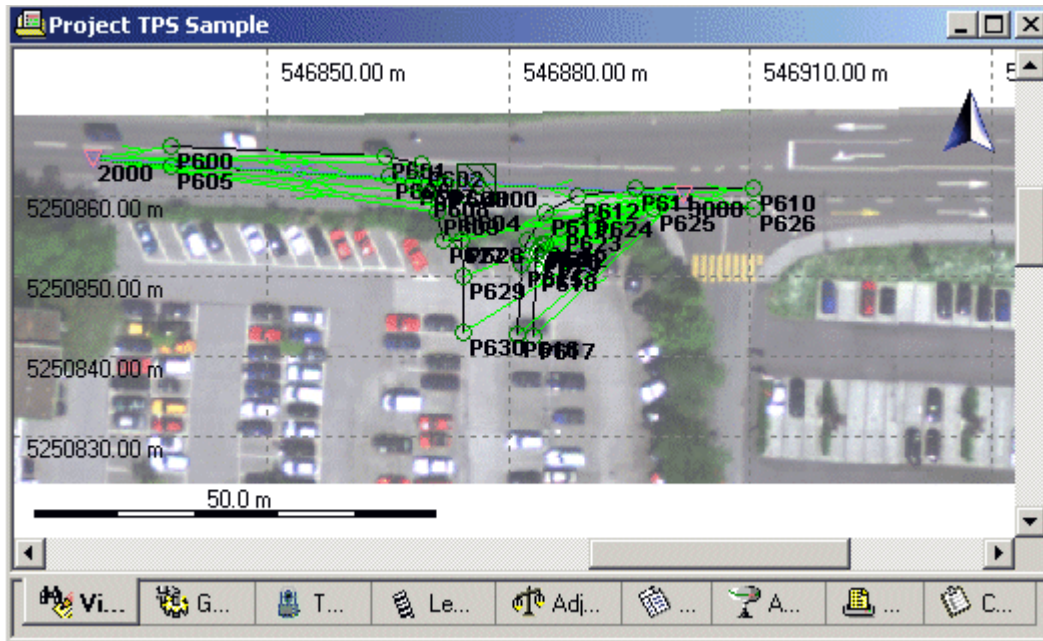

- In the **General** tab make sure that the project *TPS Sample* is selected for import.
- Click **Assign** and then **Close**. The job data will be assigned to the project *TPS Sample* and you are returned to the **Project window** automatically.

If you **zoom into** the data details in  **View/ Edit** directly after **Import** you will [see](#) that the setups do not yet fit. Only *Navigated* coordinates were available when the SmartStation instrument was set up, and therefore the coordinates of the points 2000 and 3000 are not the final ones. Also the orientations of the setups are not correct since accurate coordinates were not available for the backsight observations.





In a first step we have to derive the correct station coordinates for the Setup points.

Switch to the  **GPS-Proc** view and select the baselines to be processed. The GPS-Processing view graphically displays all observation intervals.

- If you have gone through TPS Tour III there will already be lots of observation intervals from JOB_5. To get a better overview you might right-click on the interval of Point **System1200** and select **Zoom to Interval** from the context menu.
- Click on  **Select Mode: Reference** from the toolbar. The cursor indicates Reference.
- Click on the horizontal bar of point System 1200 to select it as the Reference.
- Click on  **Select Mode: Rover** from the toolbar. The cursor indicates Rover.
- Click on the horizontal bars of the points 2000 and 3000 to select these observation intervals as Rover.
- Click on  **Process** from the toolbar.

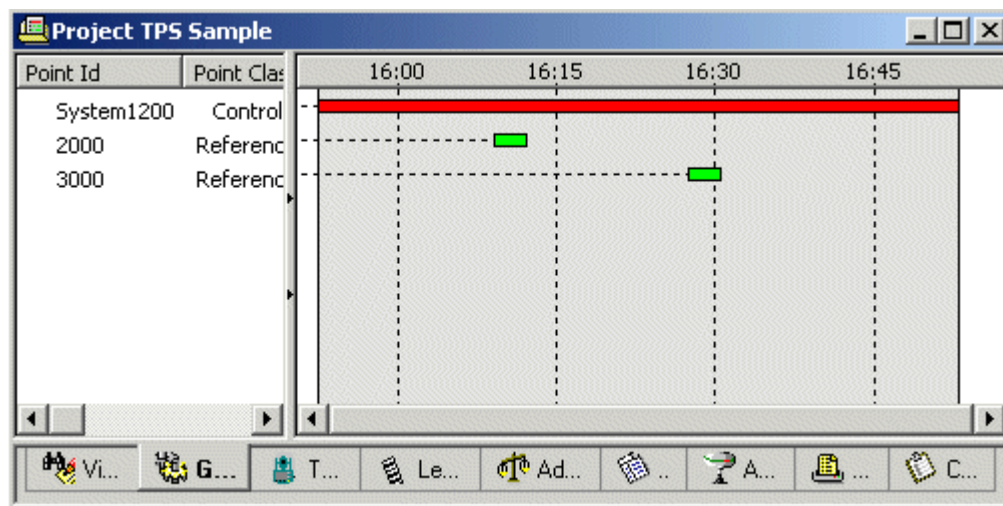
[Illustration:](#)



When the processing run is complete the display automatically switches to the **Results**  view allowing you to examine and store the processed baselines. The rover points of all baselines for which ambiguities have been resolved are automatically selected.

- To store the selected baselines press  **Store** from the toolbar or right-click into the view and select **Store** from the context menu. The newly calculated coordinates for points 2000 and 3000 will be added as *Measured* point triplets.
- The **TPS Processing Guide** dialog opens. This dialog allows to automatically update the SmartStation setups with the newly calculated coordinates and to re-calculate the orientations for these setups. While it is normally recommended (and a lot easier) to accept this update, we will perform the necessary updates manually in Lesson 2. Therefore press **Cancel**.

Continue with **TPS Tour VI - Lesson 2: Updating the Setups**.

TPS Tour VI - Lesson 2: Updating the Setups

The objectives of this lesson are:

- To **update** the SmartStation **Reference coordinates** with the *Measured* coordinates computed in Lesson 1.
- To **update** the orientations for the SmartStation **Setups** using the new *Reference* coordinates for the backsights.



After having successfully processed and stored the GPS Baselines from the GPS Reference to the SmartStation points new *Measured* point triplets have been added for points 2000 and 3000. This operation did not automatically modify the *Reference* triplets of the Setup points. They have to be **updated manually**:

1. In  **View/ Edit** select point **2000** and Point **3000**. Select **Update Reference triplets...** from the background context menu.
2. In the **Update Reference triplets** dialog the *Measured* triplets are already selected for each of the points. The *Measured* triplet is the result of the GPS-Processing.

On pressing **OK** the existing *Reference* coordinates will be **replaced** with the *Measured* coordinates, i.e. the new *Reference* coordinates will be the same as the *Measured* coordinates.

3. Leave the dialog with **OK**.

Now we have, like in TPS Tour V, updated the *Reference* coordinates of the Setups **2000** and **3000** but not so far their orientation. This is the reason why for point 4000, which was measured from both setups, the averaging limit is still exceeded. To get it right we have to **update** the orientations of the **Setups**:

1. Return to the  **TPS-Proc** view and open the **Setups** report view by clicking onto the  **Setups** node in the tree-view.
2. Change the 'Allow automatic update' flag to 'Yes' for setups **2000** and **3000**. **Select** both setups in the TPS-Proc report view and right-click into the selection. From the context menu select **Allow automatic update**. See how the flag changes to 'Yes'.
3. Now, make use of the **Update Setups** functionality. From the **TPS-Proc** main menu select **Update Setups**.

The orientation on 2000 and on 3000 will be re-calculated. When you return to **View/Edit** you will [see](#) that the averaging limit is no longer exceeded for point 4000 and that finally everything fits.

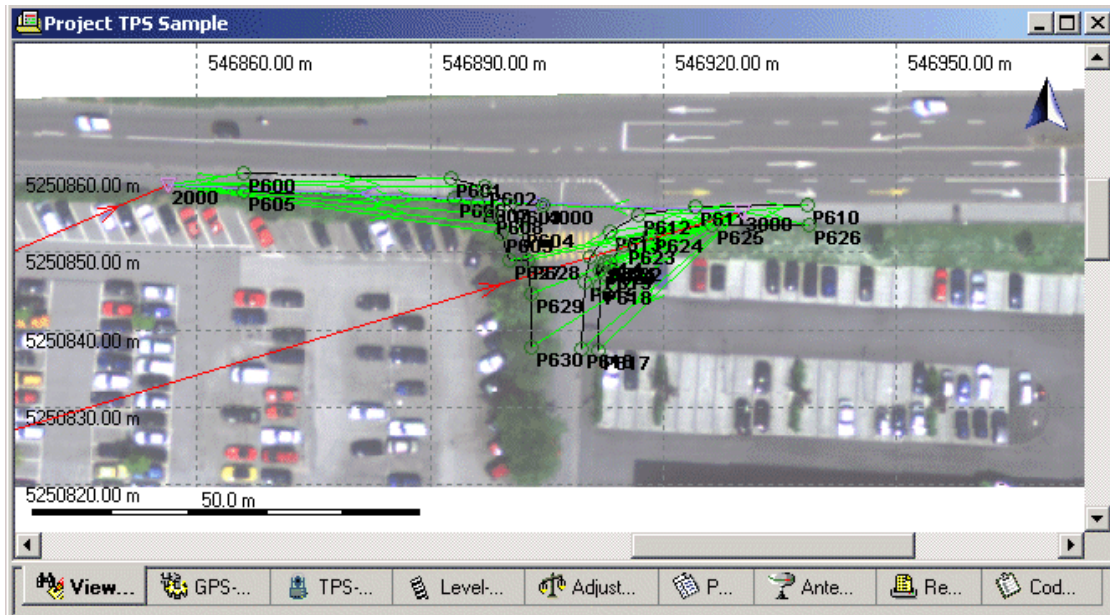

Remember: Updating the Reference triplets and re-calculating the setups could have been done automatically by using the [TPS Processing Guide](#) when storing the GPS baseline results.

Congratulations! - You have successfully completed Quick Tour VI.

Level Tutorial

Level Tour: Level-Processing

Level Tour: Level-Processing

This Quick Tour is a step-by-step tutorial in which you learn to process Leica digital level data. The tutorial takes you from importing the raw data to exporting the final coordinates.

To complete this exercise the **Level-Processing** option has to be included in your [licence](#).

Start this Quick Tour with [Level Tour - Lesson 1: Importing Raw Data](#).

Level Tour - Lesson 1: Importing Raw Data

In this lesson you will learn how to import Leica digital level data and simultaneously create a new project.

- Start up LGO and select Import Raw data  either from the Import main menu or from the Toolbar or from the **Tools** List Bar.

The **Import Raw Data** dialog opens. In this dialog:

- Select **GSI (Observations)** under **Files of type**.
- Browse to the directory that contains the sample data under **Look in**. By default the sample data will be installed in *C:\Documents and Settings\All Users\Documents\Lgo\Sample data\Import\Level\GSI*.
- Check **Include subfolders**. All level observations contained in the two sub-directories *bffb_loop* and *bf_samples* will be imported in one run.
- Click the **Import** button.

The **Assign** dialog opens. In this dialog create a new project to import the raw data into:

- In the General tab right-click on Projects in the tree-view and select **New**.

While the **Assign** dialog stays open in the background you'll enter the **New Project** dialog.

In the **New Project** dialog:

- Under **Location** browse to where you want the Project to be stored, e.g. in *C:\Documents and Settings\All Users\Documents\LGO\Projects*.
- Enter the **Project Name**. A directory of the same name will be added to the path automatically. The project's files will be stored into this directory.
- Click **OK**. The new project will be created and the **New Project** dialog will be closed. You are returned to the **Assign** dialog.

In the **Assign** dialog the new project is selected automatically.

- Click **Assign** and then **Close**. The raw data will be assigned to the new project and the **Project window** opens automatically.

Continue with [Level Tour - Lesson 2: Processing Level Data](#).

For more information **see also**:

[How to Import Level Raw Data](#)

[Create a new Project](#)

Level Tour - Lesson 2: Processing Level Data

In this lesson you will learn how to process and store level data.

In the Project window you may switch between different **Tabs** to display the project's content.



Click the **Level-Proc** tab. In the Level-Proc tabbed view you can view and select the level lines to be processed.

- Click on **Jobs** in the Tree View. This shows the details of each job imported into the project
- Click on **bffb_loop** in the Tree View. This displays the details of each level line within the Job.
- Click on **Line001** in the Tree View. This displays the booking sheet for the level line *bffb_Loop / Line 001*.

You can choose different level processing parameters. Open the **Processing Parameters** dialog either from the toolbar , the main menu (Level-Proc / Processing Parameters) or by accessing the context menu in the Level-Proc tab report view.

- For the level line *bffb_loop / Line 001* select the following parameters:
- **Adjustment Method:** By Distance, **Misclosure:** a = 0.002 m and b = 0.005 m, **Height Error per Station** = 0.0005 m, **Distance Balance** = 10.0 m
- Click on **Process** from the toolbar.

After the processing run is completed the display will automatically switch to the **Results** view allowing you to examine and store the processed points. The points of the level line are automatically selected.

- To store the selected points press **Store** from the toolbar or right-click into the view and select Store from the context menu.

You have two more level lines left to process. These lines start at points with a known height and finish at different points with known heights.

- Return to the Level-Proc tab, open the **Processing Parameters** dialog by pressing the toolbar button .
- Change the Level Processing Parameters to **Adjustment Method:** By Station.
- View the *bf_Samples / Line 001* booking sheet by selecting its icon in the Level-Proc Tree View.

To define these lines as starting and ending at known points they must have the **Point Class Control**. The Start Point (100) is automatically set to **Point Class: Control**. You must set the final point to control and define its height:



- Highlight the final Point (105).
- Select **Create Control** from the toolbar.
- Double-click on the height of Point 105 and modify it to 100.0400 meters

You must also set the final point of *bf_Samples / Line 002* to Control and define its height:

- Open the *bf_Samples / Line 002* booking sheet.
- Highlight the final point (1004).

- Select **Create Control**  from the toolbar.
- Double-click on the height of Point *1004* and modify it to 10.0000 meters.

You must now process these lines. It is possible to process these lines together:

- In the Level-Proc Tree View select the *bf_Samples* job ( **bf_samples**). The details of the two level lines are displayed in the Report View.
- Select both of the level lines in the Report view by clicking on each line while holding down the 'Shift' button
- Select  **Process** from the toolbar.

Again the display will automatically switch to the **Results** view allowing you to examine and store the processed points. The points of the level lines are automatically selected.

- To store the selected points press **Store** from the toolbar or right-click into the view and select **Store** from the context menu.

You can view all the calculated points by clicking on the **Points** tab. For points where more than one measurement exists an average is automatically computed. To inspect the computed points right-click on a point and select **Properties**.

You have now finished the processing of the level data. Continue with [Level Tour - Lesson 3: Exporting an ASCII File](#).

For more information **see also**:

- [Level-Processing View](#)
- [Level-Processing: Booking sheet](#)
- [Processing Level lines](#)
- [Create Control](#)
- [Point Classes and Subclasses](#)

Level Tour - Lesson 3: Exporting an ASCII File

In this lesson you will learn how to export coordinates to a user defined ASCII file.

- While the project is still open select Export ASCII data  either from the Export main menu or from the Toolbar or from the **Tools** List Bar.

The **Save File As** dialog opens. In this dialog:

- Select **Text File** under **Save as type**.
- Enter a file name.
- Click on the **Settings** button to change the export settings.

The **User defined Export Settings** dialog opens.

- In the General tab select Coordinate Type **Local** and **Grid** and Height mode **Orthometric** (only necessary in the combined installation of LGO).
- Change the **Coord. Class** to **Main**. The coordinates of the highest point class will be exported.
- In the Point tab select **Point Id** and **Orth. height** to be exported.
- Click on **OK** to close the Settings property page and finally **Export** to write the file. You can now examine the ASCII file that you just created with a text editor.

Congratulations! You have successfully completed this Quick Tour through LGO.

For more information **see also**:

[User-defined ASCII File Export](#)

[User-defined Export Settings](#)

User Interface

Explorer View

How to use the Explorer-View

To provide you with an optimum and consistent working environment, the Explorer-View is used as the working area. In terms of appearance and functionality this view is very similar to the Explorer of Microsoft Windows™.

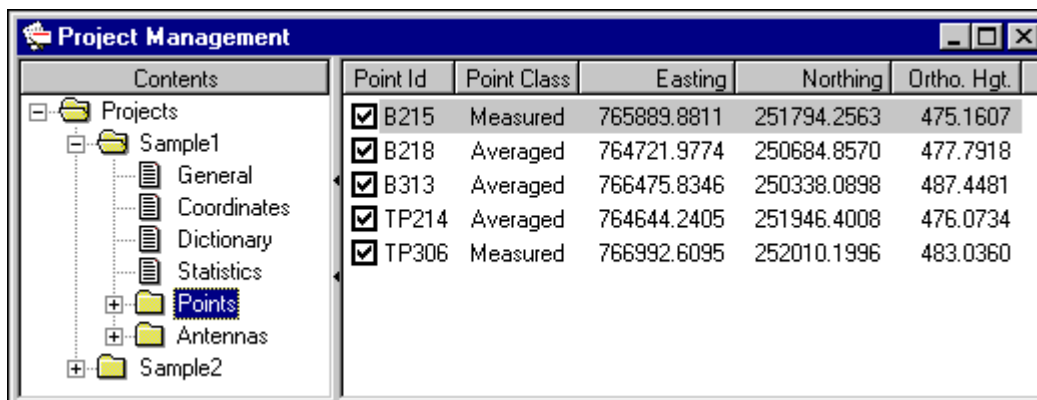

Normally you will find a [Tree-View](#) pane on the left hand side and a [Report-View](#) or [Property-View](#) pane on the right hand side of the Explorer View window.

Related topics:



[Tree-View](#)

[Report-View](#)

[Property-View](#)

[Property-Sheet/Page](#)

Tree-View

The **Tree-View** pane provides you with an overview of the items you are currently working with, in an expandable/collapsible hierarchy of folders  and pages .

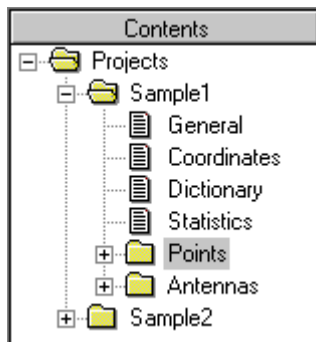

Opening and Closing folders

When an Explorer-View is first opened the folders display, but each individual folder is closed (collapsed). If the folder contains items, a plus box  appears at the left side of the folder icon. When you open a folder, you expand the hierarchy so you can see the contents within it.

Open (expand) a folder:

- From the folder you want to open, click the **plus box** .



When a folder is opened, a minus box  appears at the left side of the folder icon. Each item in the folder is displayed.

Close (collapse) a folder:

- From the folder you want to close, click the **minus box** .

When you close a folder, you collapse the hierarchy so you do not see the contents within it.

View the data:

- Click on a page  or a folder  to list the data of that item in the **Report View** or **Property View** on the right pane.

Tips:

- If you right-click on any item in a folder, a **Context-Menu** will appear with the available options for working with that item. For example, if you right-click on the folder called *Projects* in the Project Management component, a menu list appears which, for example allows you to create a new project by using the command *New...*
- Use the up / down arrow keys to toggle through the Tree-View folders.
- Use the right / left arrow keys to open (expand) / close (collapse) a folder.

Related topics:

[Report-View](#)

[Property-View](#)

[Property Sheet/Page](#)

Report-View

The **Report-View** pane lists the data sets by rows and columns. Each data set is displayed in a separate row. The column heading describes the different data items. The Report-View is used to display the contents of a Tree-View folder.

Point... ▲	Point Class	Easting	Northing	Ortho. Hgt.
<input checked="" type="checkbox"/> B215	Measured	765889.8811	251794.2563	475.1607
<input checked="" type="checkbox"/> B218	Averaged	764721.9774	250684.8570	477.7918
<input checked="" type="checkbox"/> B313	Averaged	766475.8346	250338.0898	487.4481
<input checked="" type="checkbox"/> TP214	Averaged	764644.2405	251946.4008	476.0734
<input checked="" type="checkbox"/> TP306	Measured	766992.6095	252010.1996	483.0360

Sort the list

- Click on the desired column heading to **sort** the list by this item (type) in **ascending** order. If you click again on the same heading the data is sorted in **descending** order. A triangle pointing upwards indicates that the list is sorted according to that column in ascending order. A triangle pointing downwards indicates descending order.
- Alternatively, right-click on a particular column heading and select **Ascending** or **Descending** from the context-menu.
- Select **Original Order** from the context-menu to remove all sorting criteria and restore the original sorting.
- Select **By multiple columns** from the context-menu to determine a hierarchy for the sorting criteria you specify. In the **Sort by multiple columns** dialog specify up to three columns by which the data shall be sorted in ascending or descending order. According to the specified ranking of the columns the data will be sorted:

first, by the column specified first - if one or more items in this column are identical the data will be sorted by the second column, etc., e.g.

Point Id	Point Class ▲	Ortho. Hgt. ▼
<input checked="" type="checkbox"/> B215	Measured	475.1607
<input checked="" type="checkbox"/> TP306	Measured	483.0360
<input checked="" type="checkbox"/> TP214	Averaged	476.0734
<input checked="" type="checkbox"/> B218	Averaged	477.7918
<input checked="" type="checkbox"/> B313	Averaged	487.4481

The ranking of the columns is indicated by dots above the sorting triangles.

Move a column

- Click on a column heading and move the column to the left or the right while you keep the left mouse button pressed.

Hide a column

- Right-click on the particular column and select **Hide**.

Note: The first column is always visible and can not be hidden.

View a column

- Right-click on a column heading, click on **View** and select an individual item from the list or select **View all** to unhide all the hidden columns.

Configure the columns

- Right-click on the column heading and select **Columns...** In the Columns dialog configure
 - which columns you want to see (via the check-boxes or via the **Show/ Hide** buttons).
 - the column order (via the **Move up/ Move down** buttons).
 - the column width (in pixels).Click **Reset** to restore the original settings.

Change the column width

- Move the cursor to the right side of the column heading until the separator **+** appears. **Drag** the boundary of the column heading until the column is the width you want.
- Right-click on a column heading, select **Auto arrange**. The width of each column is arranged automatically according to the widest item (header or data item).
- Type **Ctrl-+** to arrange the width of all columns automatically according to the widest data item. This command ignores the width of the column header.
- Double click on the separator **+** arranges the width of that column automatically according to the widest data item. This command ignores the width of the column header.

Edit individual items of a data set

- Select an individual item and click it again (slow double-click) or right-click and select **Modify**. Change the value and press **Enter**.

Note: Only items that are editable can be changed.

Delete a data set

- Right-click on a data set and select **Delete**. Select **Yes** to confirm or **No** to close without deleting.

Note: If you select a series of data sets all of them can be deleted at once.

Save the view as a text file

- Right-click anywhere in the Report-View and select **Save As**. The Save As dialog box appears, which allows you to save this whole view or just the selected lines as a text file for further use in a spreadsheet or text editor program.

Find a data set

- Right-click anywhere in the Report-View and select **Find...** The Find dialog box appears, which allows you to find and select particular data sets in a huge list of data.

Select checked items

- Right-click on a data set and select **Select checked items**. All checked lines in the report-view will be selected.

Print the view

- In the main menu select **File** and **Print...** The **Print** dialog box appears. Click **OK** to confirm.
Note: This command will print the whole content of the Report View or Property View.
- Alternatively in the main menu select **File** and **Print Preview**. The **Print Preview** window lets you view the print sheet(s) on the screen before you print it.

Tips:

- If the list does not fit into the window use the **Scroll bar** along the right side or bottom of a window. Drag the shaded bars or use the arrows to scroll to another part of the list.
- If you right-click on any item in the list a **Context-Menu** will appear with the available options for working with that item.
- Right-click on an item and select **Properties** to open a **Property Sheet/Page**, which also allows you to edit the items.
- To activate/ deactivate all items you may first use Ctrl-A to select all items and afterwards click on any checkbox to enable/ disable all.

Related topics:

[Tree-View](#)

[Property-View](#)

[Property Sheet/Page](#)

Property-View

The **Property-View** pane lists the data sets by property and value.

The following sample shows a Property-View like it is used to view and/or edit the Project Properties.

Property	Value
Name	Ephe try
Location	D:\ski_projects\Turkey\
Date Created	03/06/2000 08:44:19
Last Used	05/09/2000 15:01:27
Avg. Limit Pos.	0.0750
Avg. Limit Hgt.	0.0750
Coordinate System	Sample RT
Compute Mod. Grid Coordinates	No
Avg. Combined Factor	1.0000
Northing Shift	0.0000
Easting Shift	0.0000
Time Zone	0h00'
Manager	
Client	
Street	
Map Reference	
Print Header	
Print Footer	
Note	

Edit a data item

- **Double-click** on the particular item or right-click and select **Modify**. Change the value and press **Enter**.

Note: Only items that are editable can be changed.

Tip:

- If you click anywhere in the Property-View with the right mouse button, a **Context-Menu** appears listing all available commands. (E.g. New, Open or Delete).
- Right-click anywhere in the Property-View select **Properties** to open the **Property Sheet/Page**, which also allows you to edit the items.
- Right-click in an input field and the **Edit Context-menu** appears, allowing you to access commands such as Cut, Copy, Paste etc.

Related topics:

[Tree-View](#)

[Report-View](#)

[Property-Sheet/Page](#)

Drag and Drop (Copy & Paste)

LGO is a fully multitasking software environment allowing you to run different tasks at a time. Thus, several Projects may be open at a time and information such as Points or Baselines can easily be exchanged between Projects using Drag & Drop or Copy & Paste. Data may be dragged or copied between Report-Views and Graphical Views.

You can also Drag and Drop or Copy and Paste data items out of an LGO Report-View to external text editors or spreadsheet programs.

Drag and Drop



- Display both the source and the target window on the screen.

If the **source** window is the **Points** view then you may select one or select a series of point(s) and drag it/ them to the target window by keeping the left mouse button pressed and drop it/ them by releasing the left mouse button.

If the **source** window is the **Adjustment** graphical view you may drag and drop single points or observations. Keep the **Shift**-key pressed to **temporarily switch off** the **Panning** mode. Observations may only be dragged to another Adjustment view. If you select a series of points and/ or observations use Copy & Paste instead of Drag & Drop.

Copy & Paste has basically the same effect, but does not require both windows to be open at the same time.

Copy & Paste

- If the **source** window is the **Points** view then you may select one or select a series of point(s). Select  **Copy** from the **Edit** menu or Toolbar (or press **Ctrl+C** on the keyboard). Activate the target window and select  **Paste** from the **Edit** menu or Toolbar (or press **Ctrl+V** on the keyboard).

If the **source** window is the **Adjustment** graphical view you may Copy & Paste single points or observations. Observations may only be copied to another Adjustment view. You may also select a series of points and/ or observations to be copied.

The following rules apply when data items shall be copied by using Drag & Drop or Copy & Paste:

Points

Points may be copied between projects from the **Points View** to another Points View or a graphical view (**Adjustment** or **View/Edit**). Points may also be copied from a graphical view to another graphical view or to the Points view of another project.

And points may be copied from the Points view to an external text editor or spreadsheet program.

Observations in graphical views:

Observations may only be copied from the optional **Adjustment** component of a project to the Adjustment component of another project.

Antennas (GPS only)

Antenna definitions may be copied between the **Antenna Management** and the **Antennas View** of a project.

All

Any data item(s) may be copied from a Report-View to an external text editor or spreadsheet program. This may be useful for example as an alternative to Save as.

Related Topics:

[Notes about Drag and Drop Points](#)

Property-Sheets

Property Sheets/Pages

Property-Sheets are used whenever the user is requested to manually enter or edit data. A Property-Sheet can also be used to view data.

The following sample shows a Property-Sheet like it is used to view and/or edit the Project Properties. In this example the Property-Sheet consists of four Property-Pages (General / Coordinates / Dictionary / Codelist Template).

The screenshot shows a dialog box titled "Project Properties" with four tabs: "General", "Coordinates", "Dictionary", and "Codelist Template". The "General" tab is active. It contains the following fields and controls:

- Project Name:** A text input field containing "Sample-BFR".
- Location:** A text input field containing "D:\ski_projects\Sample-BFR" with a browse button (...).
- Limits for Automatic Coordinate Averaging:**
 - Max. Distance between different solutions (Position):** A numeric input field with "0.075" and a unit "m".
 - Max. Distance between different solutions (Height):** A numeric input field with "0.075" and a unit "m".
- Time Zone:** Two spinners, one for hours (set to 1) and one for minutes (set to 0).
- Buttons:** "OK" and "Cancel" buttons at the bottom right.

Data that is displayed in an input field with a grey background cannot be edited at the particular time or instant. Data that is not displayed in an input field is for information purposes only.

Switch between pages

- If the Property-Sheet contains more than one page you can switch between the pages by clicking on the corresponding **Tabs** on the top left corner of the dialog.

Enter or edit data

- Enter your input or make your changes. Close the Property-Sheet by using **OK** to confirm or **Cancel** to discard the changes.

Note: Some Property-Sheets contain an **Apply** button. Pressing this button applies any changes without closing the Property-Sheet.

Tip:

- If you right-click in any input field the **Edit Context-Menu** appears, allowing you to access commands such as Cut, Copy, Paste etc.
- In some Property Sheets (e.g. *New Point*), the **Apply** button allows you to enter a series of data sets without leaving the Property Sheet.

Main and Context Menus

Main Menu

The main menu provides you with a special feature. When you are in an open project a dynamic menu entry appears. Depending on which of the tabbed view you have currently entered, the dynamic menu entry is adapted to present you with view specific menu items.

E.g. when you are in the **Points** tab you'll find the menu entry **Points** between the **Tools** and **Export** menu entry. When you go to the **View/Edit** tab then the dynamic menu changes to the entry **View/Edit** between the **Tools** and **Export** menu entry.

Context-Menu

Upon right-click on any element or item a context sensitive menu will appear listing all useful commands available at the particular instant. If you right-click on an item of the screen the command useful for that particular item will be listed. If you right-click on the background of the view the most important commands for that View are listed.

Only the commands that are available at the particular time or instant are active. Inactive functions are listed in Grey color and can not be accessed.

Tip:

- If you right-click on an input field the **Edit Context-Menu** appears. This is a special Context-Menu allowing you to access commands such as Cut, Copy, Paste etc.

Edit Context-Menu

The Edit Context-Menu is a special Context-Menu that appears upon right-click on an input field. The following commands are available:

Insert

Lists the last entries (max. 10) for the particular input field. Select from the list to make your choice.

Undo

Use this function to undo the last change to the input field.

Redo

Use this function to redo the last change to the input field.

Cut

In the input field, select the text you want to remove from the input field. Use the right mouse button to click the selected text, and then click **Cut**.

Copy

In the input field, select the text you want to copy to another input field. Use the right mouse button to click the selected text, and then click **Copy**.

Paste

In the input field, place the cursor where you want to insert the text. Use the right mouse button and then click **Paste** to insert the text you have cut or copied.

Delete

Use this function to delete the content of the input field. If you previously select part of the input field, only this part will be deleted.

Select All

Use this function to select the whole content of the particular input field.



List Bar

List Bar

The List Bar is the navigation tool that lets you easily access the different components and tools of LGO or Flex Office. The List Bar is a listing of icons on the left side of the screen. It may show up to three groups of icons. On the List Bar click the buttons as listed below to switch between the different groups:



Tip:

- Select **List Bar** from the **View** menu to switch the List Bar off or on.
- Right click on the background of the List Bar and switch between displaying **Small Icon** or **Large Icon**.
- If not all icons of a List Bar are visible use the  or  buttons to scroll up or down.

List Bar: Management

In the List Bar click on the **Management** button to list the following shortcut icons. Click on an icon to get more information about the selected Management component.



Projects: Opens or switches to the Project Management.



Coordinate Systems: Opens or switches to the Coordinate System Management.



Antennas: Opens or switches to the Antennas Management.



Codelists: Opens or switches to the Codelist Management.



Satellite Availability: Opens or switches to Satellite Availability.



Precise Ephemeris: Opens or switches to the Precise Ephemeris Management.



Scripts: Opens or switches to the Script Management.



Report Templates: Opens or switches to the Report Template Management.



Image Referencing: Opens or switches to the Image Referencing.

Note:

- If you click on an icon the first time it will start the selected Management component. If you click on an icon of a component that is already running, it will switch to the component.

List Bar: Tools

In the List Bar click on the **Tools** button to list the following shortcut icons. Click on an icon to get more information about the selected Tool.



Import Raw Data: Click to start the Raw Data Import tool.



Import ASCII Data: Click to start the ASCII Data Import tool.



Export ASCII Data: Click to start the ASCII Data Export tool.



Export FBK file: Click to start the Export FBK file tool.



Export RINEX Data: Click to start the RINEX Export tool.



Export GIS/CAD Data: Click to start the GIS/CAD Export tool.

Note: This tool is only available if the GIS/CAD option is included in your [licence](#).



Export LandXML file: Click to start the LandXML Export tool.

Note: This tool is only available if the Export LandXML option is included in your [licence](#).



Datum and Map: Click to start or switch to the Datum and Map tool.

Note: This tool is only available if the Datum and Map option is included in your [licence](#).



Data Exchange Manager: Click to start or switch to the Data Exchange Manager.



Software Upload: Click to start the Software Upload tool.



Format Manager: Click to start the Format Manager.

Note: For further information see the Online Help of the Format Manager.



Configuration Manager: Click to start the Configuration Manager.



Design to Field: Click to start the Design to Field tool.

Note:

- If you click on an icon the first time it will start the selected tool. If you click on a tool that is already running, it will switch to it.

List Bar: Open Documents

In the List Bar click on the **Open Documents** button to list the following shortcut icons.



Click to switch to the selected Project.



Click to switch to the selected Report.



Click to switch to the selected GPS-processing Analysis window.



Click to switch to the selected COGO Calculation window.



Click to switch to the selected Satellite Availability window.

Note:

- This List Bar group is only available if you have previously opened at least one project or any other of the above listed components.

Toolbars

Toolbars

Toolbars allow you to organise the commands you use most often the way you want to, so you can find and use them quickly. You can easily customize toolbars - for example, you can add and remove buttons, create your own custom toolbars, hide or display toolbars, and move toolbars.

By default the **Menu bar** and the **Standard** Toolbar are visible.

The **Menu bar** is a special toolbar at the top of the screen that contains menus such as **File**, **Import** and **Edit**. You can customize the menu bar the same way you customize any built-in toolbar; for example, you can quickly add and remove buttons and menus on the Menu bar, but you can't hide the Menu bar.

The **Standard** Toolbar contains a selection of the most useful tools. The **Standard (compact)** is a smaller Toolbar that may be used instead of the Standard Toolbar if your screen resolution is less than 800 by 600 pixels, e.g. for notebook PC's.

- Move the cursor over a Toolbar button to display short description (Tooltip).
- Click on a Toolbar button to access the command the button is associated with.

Select from the index to learn more about toolbars:

[Display a Toolbar](#)

[Create a new Toolbar](#)

[Delete a Toolbar](#)

[Customize a Toolbar](#)

[Reset a Toolbar](#)

Display a Toolbar

Enables you to display or hide predefined or user defined toolbars.

1. From the **View** menu select **Toolbars...**
or right-click on an existing Toolbar.
2. From the list of available Toolbars check the Toolbar(s) you want to display and uncheck the Toolbars you want to hide.
3. Press **Close** to confirm.

Note:

- The Menu bar is a special Toolbar at the top of the screen that can not be hidden.
- Uncheck **Show Tooltips** if you do not want to display them.
- Uncheck **Cool Look** to display each Toolbar button highlighted.

Create a new Toolbar

Enables you to create new user defined toolbars.

1. From the **Tools** menu select **Customize...** or right-click on an existing Toolbar.
2. Click the **Toolbars** tab and select **New**
3. Enter a **Toolbar name** and press **OK** to confirm. A new empty Toolbar will be visible on the screen.
4. Click the **Commands** tab.
5. Select a **Category** and drag a **Button** (command) to the new Toolbar.
Note: To delete a Button drag it off the Toolbar.
6. Repeat step 5 until all the desired buttons are added.
7. Press **OK** to confirm or **Cancel** to abort the function

Note:

- A Toolbar may be positioned anywhere on the screen by dragging it.
- User-defined Toolbars may –in contrast to the pre-defined Toolbars- be deleted. When selecting such a Toolbar the **Reset**-button changes into a **Delete**-button which will remove the newly defined Toolbar from the list. For further information see the topic [Delete a Toolbar](#).

Delete a Toolbar

Enables you to delete a **user-defined** toolbar.

1. From the **Tools** menu select **Customize...** or right-click on an existing Toolbar.
2. Click the **Toolbars** tab and select **Delete**.

Note:

- Only new, user-defined Toolbars may be **deleted**. The predefined Toolbars may only be hidden or **Reset**. For more information on how to define your own Toolbars have a look at [Create a new Toolbar](#).

Customize a Toolbar

Enables you to modify a predefined or user-defined Toolbar.

1. From the **Tools** menu select **Customize...** or right-click on an existing Toolbar.
2. Click the **Commands** tab.
3. Select a **Category** to display all available buttons of the category.
4. Drag and drop a **Button** (command) to a particular place on the Toolbar.
Note: To delete a Button drag it off the Toolbar.
5. Repeat step 4 until the Toolbar is modified.
6. Press **OK** to confirm or **Cancel** to abort the function

Note:

- To restore the original settings of a predefined Toolbar select the Toolbar from the list and press **Reset**.
- User-defined Toolbars may be **deleted**.
- You may also drag buttons (commands) from one Toolbar to another.
- To create a separator (vertical line) between two buttons on the Toolbar, drag one of the buttons slightly to the right or left.

Window Commands

Window Commands

This software offers you a fully multitasking environment allowing you to run different tasks at the same time. E.g. several Project Windows can be open simultaneously. The Window Commands enable you to arrange the Windows the way you want.

The Window Commands are available from the **Window** menu that appears as soon as the first window is open.

- All open windows are listed under the **Window** menu. To set the active window select from the list.

Select from the list below to learn more about Window Commands:

[Close](#)

[Close All](#)

[Cascade](#)

[Tile Horizontally](#)

[Tile Vertically](#)

Close Window

To Close open Window(s):

1. Click on an open window or select a window from the list in the **Window** menu.
2. Select **Close** or **Close All** from the Window menu.

Related Topic:

[Window Commands](#)

Arrange Windows

To arrange all open windows:

- Select **Cascade**, **Tile Horizontally**, or **Tile Vertically** from the Window menu.

Note:

- Make sure all the windows you want to display are open. Closed or minimized windows will not be automatically arranged using these commands.

Related Topic:

[Window Commands](#)

Printing

Print

With this command you may print the content of the active window.

1. Select **Print** from the **File** menu or click on  from the Shortcut Bar.
2. Select a printer from the list and check the box if you want to **Print to a file**.
3. Define the print range. Select **All** or enter a range of pages.
4. Change the **Number of copies** if required.
5. Select **OK** to print or **Cancel** to abort the function.

Note:

- In the Codelist Management component you can also create an all-in-one graphical report-style printing showing Code Groups, Codes and Attributes (including Choice Lists) in one printout. For details refer to [Print a Codelist](#).

Print Preview

The Print Preview lets you view the print sheet(s) of the active window on the screen before you print it.

The following commands are available via the buttons on the top:

Print:

To open the [print dialog](#) that lets you printout the page(s).

Next Page:

To display the next page if more than one exists.

Prev Page:

To display the previous page if more than one exists.

Two/One Page:

To display two or only one pages on the screen.

Zoom In:

To enlarge the size of the preview.

Zoom Out:

To reduce the size of the preview.

Close:

To close the preview window without printing.

Tip:

- You can enlarge the preview by clicking on the particular area of the sheet.

Print Setup

The Print Setup can be changed by selecting **Page Setup** from the **File** menu.

Choose a printer and select the printing options, the paper size and format.

Management Components

Project Management

Project Management

The Project Management component enables you to create new [Projects](#), open, copy or move existing Projects and register (re-assign) old Projects. Additionally it allows you to list Project and Point Properties.

For more information about Projects refer to [Notes about Projects](#).

To start the Project Management

- From the **Tools** menu select  **Project Management** or click on  within the **Management** List Bar.

Note:

- If access to a project is denied due to missing user rights or if a project folder cannot be accessed (e.g. due to lost network connection) or if a project is no longer available at the specified location, then the project will be greyed in the Report-view. Such projects cannot be opened or deleted or copied or moved. Unregister is only impossible if permission is denied.

Select from the list below to learn more about Project Management:

[Projects](#)

[Notes about Projects](#)

[Create a new Project](#)

[Open a Project](#)

[Modify](#)

[Delete a Project](#)

[Save As](#)

[Copy a Project](#)

[Move a Project](#)

[Register a Project](#)

[Unregister a Project](#)

[Send To](#)

[Project Properties](#)

Notes about Projects

Data that **belongs together** and that you intend to **process together** should be put **into the same** Project. All Project information is stored in a database, which physically consists of a series of files with the same name as the Project. It is therefore possible to store several Projects under one directory. However, it is recommended to store each Project under a separate directory.

The term "Project" as used in LGO can be defined as a working unit for processing data. All data within any particular Project can be handled at the same time. Therefore, it is vital to put all data that is needed for data processing into the same Project. For example, if you are a GPS user and run one reference station for two groups of roving receivers (which are working at the same time but the data of which is intended to be imported into two different Projects), then the data of the reference site must be transferred to both Projects, too.

Projects can only be created and handled on a hard disk. It is not possible to do so from a local memory device.

Each Project uses its own database. Whenever data is imported into a Project (or when any other data handling is done) the Project Management keeps track of all this data handling.

Note:

- Never delete (from outside the office software environment) any of the files contained in a Project directory. Otherwise the consistency of the database will be destroyed and an unrecoverable database error will result.

The number of Projects the software can handle depends only on the storage capacity of your hard disk. If you decide to delete some of your older Projects make sure that they are saved as a backup first and then **delete them from within** LGO.

Create a New Project

1. From the **File** menu select **New Project...** or click on  from the Toolbar.
2. Enter a unique **Project Name**. The Project Name is equivalent to the filenames in which the datasets are stored. It can be up to 40 characters long, spaces and capitals are allowed.
3. Under **Location** change the path if the default is not correct.

Note: A new directory may be directly created either by typing the path or by using the browser . Root directory C:\ is not allowed.

4. Change the limits for **Automatic Coordinate Averaging** and the **Averaging Method** as required. The method **Unweighted** applies a simple arithmetic mean, whereas the method **Weighted** takes the standard deviations of the single solutions into account.
5. Change the **Time Zone** as required.
6. In the **Coordinates** page select a **Coordinate System** from the list if already defined or leave it on the default *WGS1984*. You may decide on computing **modified grid coordinates**. Tick the corresponding checkbox.
7. Enter the optional **Dictionary** parameters.
8. Change the **Codelist Template** parameters if necessary.
9. Press **OK** to confirm and open the Project or **Cancel** to abort the function.

Alternatively:

- In the Project Management right-click and select **New** will create a new Project but not open it.
- Projects may also be created during the **Raw Data Import** procedure.

Open a Project

Opening a Project displays a Project specific Tabbed-View within which all Project components and data are available.

1. From the **File** menu select **Open Project...** or click on  from the Toolbar.
2. Select a Project from the list.
3. Click **Open** to start the Tabbed-View of the Project or **Close** to abort the function.

Alternatively:

- In the Project Management double-click (fast) on a project or right-click and select **Open** from the context menu.
- Select **Recent Projects** from the **File** menu and choose one of the recently opened Projects from the list.

Note:

- If access to a project is denied due to missing user rights or if a project folder cannot be accessed (e.g. due to lost network connection) or if a project is no longer available at the specified location, then the project will be greyed in the Report-view. Such projects cannot be opened or deleted or copied or moved.

Delete a Project

1. From the **Tools** menu, select **Project Management** or click on  (Projects) from the **Management List Bar**.
2. Right-click on a Project in the Tree-View or Report-View window.
3. Select **Delete**.
4. Press **OK** to confirm or **Cancel** to abort the function.

Note:

- If you delete a Project, all its files will be physically deleted from the harddisk.
- Never delete (from outside office software environment) any of the files contained in a Project directory. Otherwise the consistency of the database will be destroyed which results in an unrecoverable data base error.
- If access to a project is denied due to missing user rights or if a project folder cannot be accessed (e.g. due to lost network connection) or if a project is no longer available at the specified location, then the project will be greyed in the Report-view. Such projects cannot be opened or deleted or copied or moved.

Copy a Project

1. From the **Tools** menu select **Project Management** or click on  in the **Management** List Bar.
2. Right-click on a Project in the Tree-View or Report-View window and select **Copy**.
3. In the directory browser enter a new **Project name**.
4. Select a directory from the browser or by entering its name under **New Location**.
5. Press **OK** to confirm or **Cancel** to abort the function.

Note:

- A new directory may be directly created either by typing the path or by using the browser context menu. Root directory C:\ is not allowed.
- To transfer a Project from one PC to another use the standard Windows Explorer (or any other file manager) to copy the Project folder. On the other PC use **Register a Project** to allocate the copied Project to the Office database.
- If access to a project is denied due to missing user rights or if a project folder cannot be accessed (e.g. due to lost network connection) or if a project is no longer available at the specified location, then the project will be greyed in the Report-view. Such projects cannot be opened or deleted or copied or moved.

Move a Project

Moves all Project specific files from a location on a drive to another location on the same or another drive.

1. From the **Tools** menu select **Project Management** or click on  in the **Management** List Bar.
2. Right-click on a Project in the Tree-View or Report View and select **Move**.
3. In the directory browser change the **Project name** if necessary.
4. Select a directory from the browser or by entering its name under **New Location**.
5. Press **OK** to confirm or **Cancel** to abort the function.

Note:

- If you move a Project, the old Project in the previous directory and all its files will be physically deleted from the harddisk.
- A new directory may be directly created either by typing the path or by using the browser context menu. Root directory C:\ is not allowed.
- If access to a project is denied due to missing user rights or if a project folder cannot be accessed (e.g. due to lost network connection) or if a project is no longer available at the specified location, then the project will be greyed in the Report-view. Such projects cannot be opened or deleted or copied or moved.

Register a project

The Project list is updated constantly. This is done automatically when you work within the Office environment. The Projects will normally always be registered.

You can, of course, use the Windows Explorer, e.g. to copy a Project folder from one PC to another. If you do so, this Project will not be registered automatically.

In this case use **Register** to link Projects that are on the hard disk but not shown in the Project list, to the Office database.

1. From the **Tools** menu select **Project Management** or click on  in the **Management** List Bar.
2. Right-click anywhere in the Tree-View or Report View.
3. Select **Register...**
4. From the browser select the directory containing the Project to register.
5. Press **OK** to confirm or **Cancel** to abort the function.

See also:

[Unregister a project](#)

Unregister a project

The **Project Management** lists all projects that are registered in the Office database. If you wish to remove a project from the list without deleting it select **Unregister** from the Context-menu.

To unregister a project:

1. From the **Tools** menu select **Project Management** or click on  in the **Management** List Bar.
2. In the Tree View or in the Report View right-click on the project to be unregistered.
3. Select **Unregister**

Unregistered Projects can be linked back to the list of projects by **registering** them again.

Note:

- To unregister more than one project at once select a series of projects and right-click onto the selected block to unregister the projects.
- If access to a project is denied due to missing user rights or if a project folder cannot be accessed (e.g. due to lost network connection) or if a project is no longer available at the specified location, then the project will be greyed in the Report-view. Unregister is only impossible if permission is denied.

Project Properties

Project Properties

This Property-Sheet enables you to display and/or modify the Project Properties.

1. Right-click on a Project in the Tree-View and select **Properties**.
2. Use the tabs to switch between the following pages:
 - General
 - Coordinates
 - Dictionary
 - Background Image
 - CAD Files
 - Codelist Template
3. Make your changes.

Note: Only the fields with white background may be edited at the particular instant.
4. Press **OK** to confirm or **Cancel** to abort the function

Note:

- When a project is open and the project window is active you may edit the project properties either
 - via Project Management or
 - via the File - Project Properties... entry in the main menu.
- Background images that have been referenced in the **Image Referencing** component cannot be attached to an open project. To attach a referenced map via the **Project Properties - Background Image** dialog close the project first.
- Dictionary information and the Time Zone cannot be changed when the project is open either.

Project Properties: General

This Property-Page enables you to display/edit General Project Properties.

Project Name:

The Project Name is equivalent to the filename in which the datasets are stored. It can be up to 40 characters long, spaces and capitals are allowed.

Location:

Path and directory under which the Project files are stored.

Automatic Coordinate Averaging:

The limit (max. distance between different solutions) in **Position** and **Height** for the automatic coordinate averaging (Mean) can be defined. See also [Point Properties: Mean](#).

Note: A solution has to comply with both limits (*Position* and *Height*) to be automatically averaged.

Averaging Method:

Choose between **Weighted** or **Unweighted** averaging. The method **Unweighted** applies a simple arithmetic mean, whereas the method **Weighted** takes the standard deviations of the single solutions into account.

Time Zone:

The Time Zone to relate the Project to local time. Reference is GMT.

Project Properties: Coordinates

This property page enables you to display/ edit the Coordinate System and the parameters for the computation of modified grid coordinates.

Coordinate System:

The coordinate system is displayed together with the **Transformation, Ellipsoid, Projection, Geoid Model** and **CSCS Model** attached to it. A coordinate system provides the information necessary to display different coordinate representations (*Cartesian, Geodetic* or *Grid*) and to transform coordinates between the *WGS84* and *Local* system. Per default the Coordinate System *WGS1984* will be defined.

Tip: Click the **View** button to open the [Coordinate System Management](#) and edit or create a new Coordinate System.

Transformation:

Displays the Transformation of the attached Coordinate System.

Residuals:

Displays the method used for the distribution of the Residuals.

Ellipsoid:

Displays the Ellipsoid of the attached Coordinate System.

Projection:

Displays the Projection of the attached Coordinate System.

Geoid Model:

Displays the Geoid Model of the attached Coordinate System.

CSCS Model:

Displays the CSCS Model of the attached Coordinate System.

Compute modified grid coordinates:

This checkbox allows you to apply an **average combined scale factor** and a shift in Northing and Easting to compute modified grid coordinates from the existing grid coordinates. If **Compute modified grid coordinates** is checked , you can manually enter the **average combined scale factor** and the two shift values. You can also have these values calculated automatically with the help of the [Compute Ave. Combined Factor](#) functionality.

The inverse factor will be applied first and the shifts will be added to all points which are either stored as Local Grid or which are converted to Local Grid to get the **Modified Grid Coordinates**. These will be displayed in separate columns in the [Points view](#).

Project Properties: Dictionary

This Property-Page enables you to display/edit the optional Dictionary items.

Manager:

Name of the Project leader

Client:

Name of the client

Street:

Address of the client

Map Reference:

Information about the map sheet corresponding with the Project area

Print Header:

Header for printouts e.g. Project details

Print Footer:

Footer for printouts e.g. company name

Note:

General notes

Project Properties: Background Image

To better visualize point locations in a local grid a map or aerial photograph of the region in which your job has been measured may be attached as a background image to a project.

Image Name:

Select the background image to be attached to the project from the list of referenced images.

Note: Images that have not been **referenced** in the Image Referencing component before will not be available in the combo box. To learn more about how to reference an image refer to: [Reference a background image](#).

Filename:

Indicates the filename and path where the selected image is stored.

Preview:

Offers a preview of the selected background image.

Note:

- Background images have to be referenced to the local grid in the [Image Referencing](#) component before they may be attached to a project.
- The background image cannot be detached or changed while the project is open. Close the project first so that the **Image Name** combo box becomes active.

Project Properties: Codelist Template

This Property-Page enables you to display or change the Codelist Template attached to the selected project. The Codelist Template defines which codes can be created inside the project specific codelist and how the codes will be displayed.

Instrument Class:

Select an [Instrument Class](#) from the list.

Codelist type:

Select between *Basic* and *Advanced*.

For more information refer to: [Codelist Type](#).

Note:

- Coding information from different codelist types may be imported into the same project via raw data import or via copy/ paste. The codelist template of the project will then define how codes and attributes are displayed.

Related Topic:

[Codelist Management](#)



Project Properties: CAD Files

In this dialog page you may select one or more **DXF** or **Shape** files to be attached to your project as CAD background maps.

CAD files attached to the project

All CAD files that are already attached to the project are listed. They may be activated or de-activated via check-boxes. Activated CAD files will be visible in **View/Edit** and **Adjustment**.

To add another CAD file to the list:

1. Press the  **Insert** button.
2. In the line which will be added to the list press the  **Browse** button.
3. In the **Select CAD files** dialog browse to the directory where your CAD file are stored.
4. Select a file and leave the dialog with **OK**.

Note: Only one file may be selected at a time.

5. Back in the **Project Properties: CAD files** page the file is by default activated .

The file will be converted into a suitable binary format.

6. Leave the dialog with **OK** and the CAD file will be attached to your project.

Note: To be able to see the graphical information stored in the CAD file as a background map in **View/Edit** or **Adjustment** the display of **CAD files** has to be switched on in the **Graphical Settings: View** dialog page.

To remove a CAD file from the list of attached files:

1. Select (highlight) the CAD file to be removed from the project and press the  **Delete** button.

The file will be removed from the list.

2. Leave the dialog with **OK** and the CAD file will be detached from the project.

You may also change the order of the CAD files in the list by selecting a file and pressing the  **Move up/down** buttons.

Coordinate System Management

Coordinate System Management

Within LGO the user can work in the global coordinate system (*WGS1984*) or in a local coordinate system. The local coordinate system may be a geodetically defined system or it may be a simple grid system with neither an Ellipsoid nor a Projection associated with it.

The Coordinate System Management is linked to a database, which is responsible for storing the parameters. This database is independent from the Project database.

Select from the list below to learn more about Coordinate System Management:

[Coordinate Systems](#)

[Transformations](#)

[Ellipsoids](#)

[Projections](#)

[State Plane Zones](#)

[Geoid Models](#)

[Country Specific Coordinate System \(CSCS\) Models](#)

Coordinate Systems

Coordinate Systems

A Coordinate System provides the information necessary to convert coordinates to different representations (*Cartesian, Geodetic, Grid*) and to transform coordinates between the *WGS1984* and the *Local* system. A Coordinate System may be attached to a [Project](#).

One or more of the following parameters define a Coordinate System:

[Transformations](#)

[Ellipsoids](#)

[Projections or State Plane Zones](#)

[Geoid Models](#)

[Country Specific Coordinate System \(CSCS\) Models](#)

Select from the index below to learn how to manage Coordinate Systems:

[Add a New Coordinate System](#)

[Modify](#)

[Delete a Coordinate System](#)

[Save As](#)

[Send To](#)

[Coordinate System Properties](#)

Add a New Coordinate System

Enables you to define a new Coordinate System for further use in a Project. Transformations, Ellipsoids, Projections and Geoid Models must be previously defined in order to be able to select them from the lists.

1. Right-click on Coordinate Systems in the Tree-View and select **New**.
2. Enter the **Name** of the Coordinate System.
3. Select a **Transformation** from the list. Transformations may be calculated using **Datum/Map** or in the case of a Classical 2D and 3D, manually entered. See also [Add a New Transformation](#).
4. If you have selected a Transformation that was previously calculated using Datum/Map you may choose how to distribute the **Residuals**. The distribution weighting may be in relation to the *distances* between the point to be transformed and the control points or by using a *Multi-quadratic* interpolation approach. *No distribution* will be selected by default.
5. Select an **Ellipsoid** for the *Local* system (System B) from the list.
Note: An Ellipsoid cannot be selected if it is already defined in the Transformation or is not required if you are using a **One Step** or an **Interpolation** Transformation.
6. Select a **Projection**, or a **Zone** from the list. Except for the Customized Projections and the State Plane Zones, which are hardwired, Map Projections have to be defined before they become available in the list. See also: [Add a New Projection](#).
Note: To switch between Projections and State Plane Zones right-click on the background of the Property-Sheet and select between **Projections** and **Zones**.
 A Projection is not required if you are using a **One Step** or an **Interpolation** Transformation.
7. If required select a **Geoid Model** from the list.
 Refer to [Coordinate System Properties: General](#) for the requirements to add a valid geoid model to the new coordinate system.
8. If required select a **CSCS Model** (Country Specific Coordinate System Model) from the list. CSCS models have to be defined before they become available in the list. See also: [Add a new CSCS Model](#).
9. Enter the optional **Note** to describe the Coordinate System.
10. Press **OK** to confirm or **Cancel** to abort the function.

Import Coordinate Systems

With the help of this functionality you are able to import coordinate systems from a file as used on the instrument.

The medium for transfer of coordinate system information is the file TRFSET.dat (for SmartWorx) or the file GPSTRF.dat (for System 500). Both files are created when:

- a coordinate system is transferred from the Office software to a System 300 or 500 sensor or a SmartWorx instrument
- coordinate systems are created on the instrument

To import one or more coordinate systems from the field system to the Office software:

1. Open the  Coordinate System Management component and select **Import Coordinate System...** from the context menu (right-click).
2. In the **Open Coordinate System file** dialog select a file from the browser. Only valid Leica Coordinate System files can be read:
 - GPSTRF.dat (= Coordinate System file from System 500)
 - TRFSET.dat (= Coordinate System file from SmartWorx).
3. Press **Open** to store the data in the Office database or **Cancel** to abort the function.



Note:

- Only one TRFSET.dat or GPSTRF.dat file may be selected at a time.
- If a coordinate system with the same name already exists, but differs in its components from the system to be imported (e.g. has a different transformation included), then a new coordinate system with <Name (2)> will be created automatically.

Delete a Coordinate System

1. Right-click on a Coordinate System in the Tree-View or Report-View and select **Delete**.
2. Press **Yes** to confirm or **No** to exit without deleting.

Note:

- Coordinate Systems that are attached to a Project are indicated by  and cannot be deleted.
- The Coordinate Systems  *WGS1984* and  *None* are hardwired and can neither be deleted nor modified.



Coordinate System Properties

Coordinate System Properties

This Property-Sheet enables you to display/ edit the Coordinate System Properties.

1. Right-click on a Coordinate System in the Explorer-View or Tree-View and select **Properties**.
2. Make your changes in the page **General**.
Note: Only the fields with white background may be edited at that particular instant.
3. Press **OK** to confirm or **Cancel** to abort the function.

Note:

- The Coordinate System  *WGS1984* is hardwired and can neither be deleted nor modified. It is the default coordinate system on GPS instruments.
- The Coordinate System  *None* is also hardwired and can neither be deleted nor modified. It is the default coordinate system on TPS instruments.

Tip:

A Coordinate System can be attached to a project by selecting it in the **Project Properties: Coordinates** page. If a coordinate system other than *WGS1984* or *None* is attached, coordinates can be displayed in either *WGS84* or *Local*.

Coordinate System Properties: General

This Property-Page enables you to display/edit the Coordinate System Properties.

Name:

Name of Coordinate System.

Transformation:

Displays the selected Transformation. Transformations may be calculated using [Datum/Map](#) or in the case of a Classical 2D and 3D, manually entered. See also [Add a New Transformation](#).

Trans. Type:

Displays the type of the Transformation selected above. Its height mode (Ellipsoidal or Orthometric) is displayed, too.

Residuals:

For Transformations calculated using [Datum/Map](#) you might choose how to distribute the residuals. The distribution weighting may be in relation to the *distances* between the point to be transformed and the control points or by using a *Multi-quadratic* interpolation approach. *No distribution* is selected by default.

Local Ellipsoid:

Displays the Ellipsoid of the Local System (System B). Most of the commonly used Ellipsoids are hardwired. However you may define your own Ellipsoid. See [Add a New Ellipsoid](#).

Note: An Ellipsoid cannot be selected if it is already defined in the Transformation or is not required if you are using a [One Step](#) or an [Interpolation](#) Transformation.

Projection (Zone):

Displays the Map **Projection** or the State Plane **Zone**. Except for the Customized Projections and the State Plane Zones, which are hardwired, the Map Projections have to be pre-defined before they become available in the list. See also: [Add a New Projection](#).

Note: To switch between Projections and State Plane Zones right-click on the background of the Property-Sheet and select between **Projections** and **Zones**.

A Projection is not required if you are using a [One Step](#) or an [Interpolation](#) Transformation. When using a Stepwise or a Two-Step transformation the Projection is already defined.

Proj. Type:

Displays the type of the above selected Projection. See [Projections](#) for a complete list of all available Projection Types.

Geoid Model:

Displays the Geoid Model. Geoid Models are not hardwired and need to be defined before they become available in the list. See also [Add a New Geoid Model](#).

Note: A geoid model, which is intended to be applied to a coordinate system defined on a local ellipsoid has to generally be based upon the same local ellipsoid.

One Step, *Interpolation*, *Stepwise* and *Two Step* transformations cannot be combined with local geodetic geoid models as these transformation types convert directly to local grid. Geoid models based on local grid are allowed with these transformation types, though.

Use of geoid models based upon the WGS84 ellipsoid:

Additionally, global geoid models which are based on the WGS84 ellipsoid can be attached to a coordinate system which itself is defined on a local ellipsoid different to the WGS84 ellipsoid if the following conditions are met:

- The transformation is of type *Classical 3D*, *One Step*, *Two Step* or *None*.
- The height mode of the transformation is *Ellipsoidal*, which means that the transformation results in local ellipsoidal heights.

The resulting WGS84 geoid separations will always be converted to the local system and be stored as local geoid separations. The orthometric heights will be calculated by applying the geoid separations directly to the WGS84 ellipsoidal heights.

CSCS Model:

Displays the Country Specific Coordinate System Model (CSCS Model). CSCS models need to be defined before they become available in the list. See also: [Add a new CSCS Model](#).

Note:

Displays the optional Note to describe the Coordinate System. The Note may be up to 48 characters long.

Last Modified:

Displays the Date and Time the Coordinate System was last modified.

Transformation

Transformation

The Transformation is normally used to transform coordinates from *WGS1984* to a *Local* system or vice versa. However it may also be used to perform a Transformation between two local systems.

A Transformation is a set of parameters that describe the conversion of coordinates from one system to another.

Transformation parameters are handled using the Coordinate System Management, but they may be determined with the [Datum/Map](#) tool.

The following Transformation approaches are available:

[Classical 2D](#)

[Classical 3D](#)

[One Step](#)

[Stepwise](#)

[Interpolation](#)

[Two Step](#)

Select from the index below to learn how to manage Transformations

[Add a New Transformation](#)

[Modify](#)

[Delete a Transformation](#)

[Save As](#)

[Transformation Properties](#)

Related topics:

[Which approach to use?](#)

Classical 2D

The Classical 2D transformation approach allows you to determine parameters for transforming the position coordinates (Easting and Northing) from one grid system to another grid system. No parameters for the height will be calculated.

This transformation determines 4 parameters (2 shifts Easting and Northing, 1 Rotation and 1 Scale factor).

Note:

- The Classical 2D transformation may only be used to export local Coordinates to an ASCII file. A Classical 2D transformation can not be used in a Project.

Other transformation approaches:

[Classical 3D](#)

[One Step](#)

[Two Step](#)

[Interpolation](#)

[Stepwise](#)

[Which approach to use](#)

Classical 3D

The Classical 3D transformation approach creates transformation parameters using a rigorous 3D Classical method.

Basically, the method works by taking the Cartesian coordinates of the GPS measured points (WGS84 ellipsoid) and comparing them with the Cartesian coordinates of the local coordinates. From this, **Shifts**, **Rotations** and a **Scale factor** are calculated in order to transform from one system to another.

The Classical 3D Transformation approach allows you to determine a maximum of 7 transformation parameters (3 shifts, 3 rotations, and 1 scale factor). However the user can select the parameters to be determined.

The Classical 3D transformation allows the choice of two different transformation models: Bursa-Wolf or Molodensky-Badekas.

For the Classical 3D transformation method, we recommend that you have at least three points for which the coordinates are known in the local system and in WGS84. It is possible to compute transformation parameters using only three common points but using four produces more redundancy and allows for residuals to be calculated.

The Advantage

- The advantages of this method of calculating transformation parameters are that it maintains the accuracy of the GPS measurements and may be used over virtually any area as long as the local coordinates (including height) are accurate.

The Disadvantage

- The disadvantage is that if local grid coordinates are desired, the local ellipsoid and map projections must be known. In addition if the local coordinates are not accurate within themselves, any new points measured using GPS may not fit into this existing local system once transformed.
- In order to obtain accurate ellipsoidal heights the Geoid separation at the measured points must be known. This may be determined from a geoidal model. Many countries do not have access to an accurate local geoidal model. See also [Geoid Model](#).

Other transformation approaches:

[Classical 2D](#)

[One Step](#)

[Two Step](#)

[Interpolation](#)

[Stepwise](#)

[Which approach to use](#)

One Step

This transformation approach works by treating the height and position transformations separately. For the position transformation, the WGS84 coordinates are projected onto a temporary Transverse Mercator projection and then the shifts, rotation and scale from the temporary projection to the "real" projection are calculated.

The Height transformation is a single dimension height approximation.

Because of the way in which the position transformation approach works it is possible to define a transformation without any knowledge of the local map projection or local ellipsoid.

As with the **Interpolation** and **Stepwise** approaches, the height and position transformations are separate and therefore errors in height do not propagate into errors in position. Additionally, if knowledge of local heights is not good or non-existent you can still create a transformation for position only. Also, the height points and position points do not have to be the same points.

Because of the way in which the transformation works it is possible to compute transformation parameters with just one point in the local and WGS84 system.

The combinations of the number of points in position and the position transformation parameters that can be calculated from them are as follows:

<u>No. of position points</u>	<u>Transformation Parameters Computed</u>
1	Classical 2D with shift in X and Y only
2	Classical 2D with shift in X and Y, Rotation about Z and Scale
more than 2	Classical 2D with shift in X and Y, Rotation about Z, Scale and Residuals

The number of points with height included in the transformation directly affects the type of height transformation produced.

<u>No. of height points</u>	<u>Height transformation based on</u>
0	No height transformation
1	Constant height transformation
2	Average constant between the two height points.
3	Plane through the three height points
more than 3	Average plane

The Advantages:

- The advantages of this method are that transformation parameters may be computed using very little information. No knowledge is needed of the local ellipsoid and map projection and parameters may be computed with the minimum of points. Care should be taken however when computing parameters using just one or two local points as the parameters calculated will only be valid in the vicinity of the points used for the transformation.

The Disadvantage:

- Disadvantages of this approach are the same as for the **Interpolation** approach in that the area of the transformation is restricted to about 10km square (Using 4 common points).

Other transformation approaches:

Classical 3D

Classical 2D

Two Step

Interpolation

Stepwise

Which approach to use

Two Step

This transformation approach works by treating the height and position transformation separately. For the position transformation the WGS 84 coordinates are first transformed using a Classical 3D **pre-transformation** to obtain preliminary local cartesian coordinates. These are projected onto a preliminary grid using the specified ellipsoid and map projection. Then the 2 shifts, the rotation and the scale factor of a Classical 2D transformation are calculated to transform the preliminary to the "real" local coordinates.

The position transformation requires knowledge of the local map projection and the local ellipsoid. However, as the distortions of the map projection are taken into account, Two Step transformations can be used for larger areas than One Step transformations.

The height transformation is a single dimension height approximation.

As with the **Interpolation**, **Stepwise** or **One Step** approaches, the height and position transformations are separate and, therefore, errors in height do not propagate into errors in position. Additionally, if knowledge of local heights is not good or non-existent you can still create a transformation for position only. Also, the height points and position points do not have to be the same points.

Because of the way in which the transformation works it is possible to compute transformation parameters with just one point in the local and WGS84 system.

The combinations of the number of points in position and the position transformation parameters that can be calculated from them are as follows:

<u>No. of position points</u>	<u>Transformation Parameters Computed</u>
1	Classical 2D with shift in X and Y only
2	Classical 2D with shift in X and Y, Rotation about Z and Scale
more than 2	Classical 2D with shift in X and Y, Rotation about Z, Scale and Residuals

The number of points with height included in the transformation directly affects the type of height transformation produced.

<u>No. of height points</u>	<u>Height transformation based on</u>
0	No height transformation
1	Constant height transformation
2	Average constant between the two height points.
3	Plane through the three height points
more than 3	Average plane

The Advantages:

- Errors in local heights do not affect the position transformation
- The points used for determining the position and height transformation do not necessarily have to be the same points.
- The distortions of the map projection are taken into account which enables you to use this kind of transformation for larger areas.

The Disadvantage:

- Knowledge of the local projection and local ellipsoid are required.

Other transformation approaches:

Classical 3D

Classical 2D

One Step

Interpolation

Stepwise

Which approach to use

Stepwise

The Stepwise transformation approach is effectively a combination of the [Classical 3D](#) approach and the [Interpolation](#) method. The position and height transformations are split into two separate components. A Classical transformation approach is used for the position transformation and an Interpolation method used for the height.

For this method, we recommend that you have at least four points for which the coordinates are known in the local grid system and in WGS84. It is possible to compute transformation parameters using only three common points but using four allows for residuals to be calculated. In addition you need to know the type of map projection on which the local coordinates are based and its parameters, as well as the local ellipsoid used.

Because this approach splits the transformation into two separate components, position and height are independent of each other as with the Interpolation method. This means that the points used for determining the position and height transformation do not necessarily have to be the same points.

As the position transformation is determined using the Classical 3D approach, the transformation area may be larger than with the Interpolation Transformation. The limiting factor for the transformation area is the accuracy of the height transformation.

Basically, the method works like this:

1. The center of gravity of the common points is computed.
2. The shifts between WGS84 and the local ellipsoid are computed.
3. The map projection is applied to the WGS84 points.
4. The Classical 2D transformation parameters are determined.
5. The height interpolation is determined.

In flat or relatively flat areas, where good heights are available in the local system, the approach will have no problem in constructing a good height transformation for relatively large areas. The more height points included, the better the height transformation will be.

In areas where it is suspected that the geoid undulation is extreme, the area over which the transformation is carried out should be reduced if accurate heighting is required. Note that position will not be affected by extreme geoid undulations.

The Advantages:

- Errors in local heights do not affect the position transformation
- The points used for determining the position and height transformation do not necessarily have to be the same points.
- The height transformation method will provide accurate height transformations without any knowledge of geoid separations as long as the geoid/ellipsoid separation is reasonably constant and does not contain sudden changes. The more height points included the better the model.

The Disadvantage:

- Knowledge of the local projection and local ellipsoid are required.

Other transformation approaches:

[Classical 3D](#)

[Classical 2D](#)

[One Step](#)

[Two Step](#)

[Interpolation](#)

Which approach to use

Interpolation

The Interpolation approach creates transformation parameters based on an affine transformation model that uses a Collocation algorithm to estimate the systematic part of the noise.

Basically what this means is that the WGS84 coordinates measured by the GPS are squeezed or stretched to fit the local grid. The local grid is constructed using the entered grid coordinates.

Position and height are treated separately and as such are independent of each other. This means that the measured position points do not necessarily have to be the same points for which height is known and that errors in local height measurement will not be propagated into the position transformation component.

The Interpolation approach has certain advantages over a traditional [3D Classical](#) approach in that parameters can be calculated without knowledge of the map projection or local ellipsoid. Additionally, heights and position are transformed independently of each other. This means that the local coordinates do not have to contain the height information. The height information may be obtained from different points.

The Interpolation approach will tend to distort the GPS measurements to fit the existing local grid measurements. This may be an advantage or disadvantage as the GPS coordinates are generally found to be better than the existing grid coordinates. That is to say that they are more homogenous.

This means that the accuracy of the GPS coordinates may be slightly compromised when using this method. This may be advantageous if you want future transformed GPS points to tie in with your existing local network.

The Advantages:

- Errors in local heights do not affect the position transformation
- The parameters can be calculated without knowledge of the map projection or local ellipsoid
- The points used for determining the position and height transformation do not necessarily have to be the same points.

The Disadvantage:

- The main disadvantage of the interpolation approach is that it is restricted in the area over which it can be applied. This is mainly due to the fact that there is no provision for scale factor in the projection. In practical terms, the area over which this transformation approach can be applied is about 10-15km square.

Other transformation approaches:

[Classical 3D](#)

[Classical 2D](#)

[One Step](#)

[Two Step](#)

[Stepwise](#)

[Which approach to use](#)

Which approach to use

This question is almost impossible to answer since the approach used will depend totally on local conditions and information.

If you wish to keep the GPS measurements totally homogenous and the information about the local map projection is available, the **Classical 3D** approach would be the most suitable.

If you are unsure of the local height information but the position information is accurate and you wish to keep the GPS measurements homogenous in position, then the **Stepwise** approach may be the most suitable.

For cases where there is no information regarding the ellipsoid and/or map projection and/or you wish to force the GPS measurements to tie in with local existing control then the **One-Step** approach may be the most suitable. Alternatively if a large number of common points are available and a more accurate approximation is required the **Interpolation** approach can be used.

The **Two-Step** approach also treats position and height information separately which allows for position only control points to be used as well. Compared to the One-Step approach, information regarding the ellipsoid and map projection has to be known. The advantage is that this approach can be used for larger areas than the One-Step.

Add a New Transformation

A Transformation is usually calculated using the [Datum/Map](#) tool. However a [Classical 2D](#) and [Classical 3D](#) may also be added manually:

1. Right-click on **Transformations** in the Tree-View and select **New**.
2. Enter the **Name** of the transformation.
3. Select the **Type** of the transformation.

Note: Only the types [Classical 2D](#) and [Classical 3D](#) may be added manually. Other transformation types can only be added (determined) using the [Datum/Map](#) tool.

4. Select the **Height Mode** of the transformation. Choose between *Ellipsoidal* or *Orthometric*.

Note: The Height Mode may only be selected for [Classical 3D](#) transformations. It can also be determined using the [Datum/Map](#) tool.

5. Enter the necessary parameters of the selected transformation type.
6. Press **OK** to confirm or **Cancel** to abort the function.

Delete a Transformation

1. Right-click on a Transformation in the Tree-View or Report-View and select **Delete**.
2. Press **Yes** to confirm or **No** to exit without deleting.

Note:

- Transformations that are currently used in a Coordinate System are indicated by  and cannot be deleted.

Transformation Properties

Transformation Properties

This Property-Sheet enables you to display/edit the Transformation Properties.

1. Right-click on a Transformation in the Report-View or Tree-View and select **Properties**.
2. Make your changes in the page **General**.
Note: Only the fields with white background may be edited at the particular instant.
3. Press OK to confirm or Cancel to abort the function.

Note:

- Only the Properties of *Classical 3D*, *Classical 2D*, *One Step-* or *Two Step* Transformations may be displayed.
- For Two Step transformations an additional page **Pre-transformation** is accessible.

Transformation Properties: General

This Property-Page enables you to display/edit the Transformation Properties. In addition to the Properties of a [Classical 2D](#) or [Classical 3D](#) Transformation those of any [One Step](#) or [Two Step](#) Transformation may be displayed.

Name:

Name of Transformation. The Name can only be changed if the Transformation is not being currently used in any Coordinate System definition.

Type:

The Type *Classical 3D*, *Classical 2D*, *One Step* or *Two Step* is displayed and cannot be changed.

Height Mode:

Displays the height mode of the selected Transformation. The height mode is set in **Datum & Map** in the [Configuration](#) page.

You may also change the height mode directly in this Property-Page. You have the choice between Ellipsoidal and Orthometric.

Last modified:

Date and Time the Transformation was last modified.

Ellip. A:

Restricts the use of the Transformation to convert coordinates of the selected Ellipsoid (Datum) only. For *Classical 3D*, *One Step* or *Two Step* it is usually set to *WGS1984*. 'Ellip. A' can only be modified if the Transformation is not currently in use in any Coordinate System definition.

Ellip. B:

If an Ellipsoid for System B is defined, the Transformation is restricted to be used to convert to the selected Datum only. For *Classical 3D* it is usually set to a local Ellipsoid. Since *One Step* Transformations typically work without knowledge of a local ellipsoid 'Ellip.B' is usually set to *None* in this case.

Projection:

Restricts the use of a *Classical 2D* Transformation to a particular Projection.

When editing the properties of a *One Step* Transformation the projection edit field is not shown at all, since *One Step* Transformations are based upon their own kind of projection. They are not related to a classical map projection.

In case of a *Two Step* transformation the projection used is pre-defined as the projection attached to the System B Project in Datum & Map.

Model:

With the *Classical 3D* Transformation you are allowed for the choice of two different transformation models: Bursa-Wolf or Molodensky-Badekas.

dx, dy, dz:

Translations in X, Y and Z direction. For a *Classical 2D*, a *One Step* or a *Two Step* Transformation dx and dy correspond to translations in local Easting and Northing.

Rx, Ry, Rz:

Rotations around the X, Y and Z axis. For a *Classical 2D* Transformation as well as for the *One Step* and *Two Step* Transformation only Rz is available. With plane grid coordinates this is the axis being perpendicular to the plane. Any rotation of such a plane system is about the Z axis.

SF:

Scale factor in ppm (e.g. mm/km)

Transformation Properties: Pre-transformation

This page is only available for **Two Step** transformations and enables you to display the properties of the Pre-transformation used in the calculation of Two Step transformations. The parameters are not editable.

Name:

Name of Pre-transformation.

Type:

The Type is fixed to *Classical 3D*. Only *Classical 3D* transformations are allowed to be used as Pre-transformations.

Last modified:

Date and Time the Transformation was last modified.

Ellip. A, Ellip.B:

Displays the ellipsoid A and ellipsoid B properties of the selected Pre-transformation.

Note: When applying a **Two Step** transformation in a coordinate system always the ellipsoid associated with that coordinate system is used for the calculation even if this collides with ellipsoid B of the Pre-transformation. The ellipsoid B of the Pre-transformation will be ignored then.

Model:

As with all *Classical 3D* Transformations the Pre-transformation can also be one of two different transformation models: Bursa-Wolf or Molodensky-Badekas.

dx, dy, dz:

Translations in X, Y and Z direction.

Rx, Ry, Rz:

Rotations around the X, Y and Z axis.

SF:

Scale factor in ppm (e.g. mm/km)

Ellipsoids





















Ellipsoids

This component enables you to manage the Reference Ellipsoids. An Ellipsoid is defined by the semi-major axis (a) and the flattening (f). The flattening is related to the semi-minor axis (b) by:



$$f = (a-b) / a$$

In LGO an ellipsoid is defined by the name, the semi-major axis (a) and the reciprocal value of flattening (1/f).

Most of the ellipsoids in use around the world are already pre-defined:

<u>Name</u>	<u>(a)</u>	<u>(1/f)</u>
 Airy	6377563.396	299.32496460000
 Airy (Modified)	6377340.189	299.32496460000
 ATS-77	6378135.000	298.25700000000
 Australian National	6378160.000	298.25000000000
 Bessel 1841	6377397.155	299.15281285000
 Clarke 1866	6378206.400	294.97869820000
 Clarke 1880	6378249.145	293.46500000000
 Everest	6377276.345	300.80170000000
 Fisher 1960 (South Asia)	6378155.000	298.30000000000
 Fisher 1960 (Mercury)	6378166.000	298.30000000000
 Fisher 1968	6378150.000	298.30000000000
 GRS 1967	6378160.000	298.24716743000
 GRS 1980	6378137.000	298.25722210088
 Hough 1956	6378270.000	297.00000000000
 Int. Hayford	6378388.000	297.00000000000
 Krassowski	6378245.000	298.30000000000
 South American 1969	6378160.000	298.25000000000
 WGS72	6378135.000	298.26000000000
 WGS84	6378137.000	298.25722356300
 Xi'an-80	6378140.000	298.25700000000

Note:

- The Ellipsoids indicated by  are hardwired and can neither be deleted nor edited.
- User defined Ellipsoids, which are currently being used in a Coordinate System, are indicated by  and may not be deleted or renamed, but the parameters may be edited.

Select from the index below to learn how to manage the Ellipsoids

[Add a New Ellipsoid](#)

[Modify](#)

[Delete an Ellipsoid](#)

[Save As](#)

[Ellipsoid Properties](#)



Add a New Ellipsoid

1. Right-click on Ellipsoids in the Tree-View and select **New**
2. Enter the **Name** of the Ellipsoid
3. Enter the **Semi-major axis (a)** of the Ellipsoid
4. Enter the **Reciprocal flattening (1/f)** of the Ellipsoid
5. Press **OK** to confirm or **Cancel** to abort the function.

Delete an Ellipsoid

1. Right-click on an Ellipsoid in the Tree-View or Report-View and select **Delete**.
2. Press **Yes** to confirm or **No** to exit without deleting.

Note:

- The Ellipsoids indicated by  are hardwired and cannot be deleted.
- User defined Ellipsoids, which are currently being used in a Coordinate System, are indicated by  and may not be deleted.

Ellipsoid Properties

Ellipsoid Properties

This Property-Sheet enables you to display/edit the Ellipsoid Properties.

1. Right-click on a Ellipsoid in the Explorer-View or Tree-View and select **Properties**.
2. Make your changes in the page **General**.
Note: Only the fields with white background may be edited at the particular instant.
3. Press **OK** to confirm or **Cancel** to abort the function.

Note:

- The Ellipsoids indicated by  are hardwired and cannot be modified.

Ellipsoid Properties: General

This Property-Page enables you to display/edit the Ellipsoid Properties.

Name:

Name of Ellipsoid. The Name can only be changed if the Ellipsoid is not hardwired or not used in any Coordinate System definition.

Semi-major axis (a):

Displays the value for the semi-major axis.

Reciprocal flattening (1/f):

Displays the reciprocal value of the flattening.

Last modified:

Date and Time the Ellipsoid was last modified

Projections

Projections

For each different mapping area the user may define a Projection. A Projection allows the conversion of *Geodetic* coordinates to *Grid* coordinates or vice versa.

Most of the Projections can be defined using one of the methods below. Alternatively you may define your own **User defined** Projection in the form of a user written program or you may use one of the Customized Projections (see below).

The Projection types that can be user defined are:

- Mercator
- Transverse Mercator (TM)
- Oblique Mercator
- Universal Transverse Mercator (UTM)
- Cassini - Soldner
- Lambert - one Standard Parallel
- Lambert - two Standard Parallels
- Polar Stereographic
- Double Stereographic
- Rectified Skewed Orthomorphic
- User defined**

Certain map Projections that are not definable using one of the methods above, have been hardwired in the Office software and can neither be deleted nor changed. These Projections are called **Customized** Projections and they have pre-defined Ellipsoids. The relationship between these Projections and the Ellipsoids are fixed as follows:

<u>Projection</u>	<u>Ellipsoid</u>
✘ Czech JTSK	Bessel
✘ Czech and Slovak	Bessel
✘ DK (S34) Bornholm	International (Hayford)
✘ DK (S34) Jylland	International (Hayford)
✘ DK (S34) Sjælland	International (Hayford)
✘ Dutch	Bessel
✘ Finnish KKJ	International (Hayford)
✘ Hungarian	GRS 1967
✘ Malayan	Everest
✘ New Zealand	International (Hayford)
✘ Romania Stereo 70	Krassowski
✘ Swiss	Bessel
✘ Swiss95	Bessel

Note:

- Defining a Coordinate System the user has the choice between Projections and **State Plane Zones**.
- A Projection is not required if you are using a **One Step** or an **Interpolation** Transformation.
- The Projections indicated by ✘ are hardwired and can neither be deleted nor edited.

- The Projections, which are currently being used in a Coordinate System, are indicated by  and cannot be deleted or renamed, but the parameters may be edited.

Select from the index below to learn how to manage the Projections

[Add a New Projection](#)

[Modify](#)

[Delete a Projection](#)

[Save As](#)

[Projection Properties](#)

Add a New Projection

1. Right-click on Projections in the Tree-View and select **New**.
2. Enter Name of Projection. It is often useful to give any Projection set a meaningful name that identifies the area in which the Projection is applicable.

For example: UTM, Zone 5, hemisphere north (UTM 5 North)

3. Select **Type** of Projection:

Mercator

Transverse Mercator (TM)

Oblique Mercator

Universal Transverse Mercator (UTM)

Cassini - Soldner

Lambert - one Standard Parallel

Lambert - two Standard Parallels

Polar Stereographic

Double Stereographic

Rectified Skewed Orthomorphic

or



User defined

4. Enter the necessary parameters of the selected Projection.
5. Choose **OK** to accept entered values or **Cancel** to abort the function.

Delete a Projection

1. Right-click on a Projection in the Tree-View or Report-View and select **Delete**
2. Press **Yes** to confirm or **No** to exit without deleting

Note:

- The Projections indicated by  are hardwired and can neither be deleted nor edited.
- The Projections, which are currently being used in a Coordinate System, are indicated by  and cannot be deleted.

Projection Properties

This Property-Sheet enables you to display/edit the Projection Properties.



1. Right-click on a Projection in the Explorer-View or Tree-View and select **Properties**.
2. Make your changes. The parameters may vary depending on the type of Projection that is selected:

Mercator
Transverse Mercator (TM)
Oblique Mercator
Universal Transverse Mercator (UTM)
Cassini - Soldner
Lambert - one Standard Parallel
Lambert - two Standard Parallel
Polar Stereographic
Double Stereographic
Rectified Skewed Orthomorphic

User defined

3. Press **OK** to confirm or **Cancel** to abort the function.

Note:

- The Projections indicated by  are hardwired and cannot be modified.
- The Projections, which are currently being used in a Coordinate System, are indicated by  and cannot be renamed, but the parameters may be edited.

Mercator

Conformal Projection onto a cylinder with its axis lying on a meridian plane. The cylinder is tangent to the sphere (ellipsoid) along the equator. The Projection is defined by:

- False Northing and False Easting
- Central Meridian

Transverse Mercator (TM)

Conformal Projection on to a cylinder with its axis lying on the equatorial plane. The cylinder is tangential to a meridian. The Projection is defined by:

- False Easting and False Northing
- Latitude of Origin
- Central Meridian
- Scale Factor at Origin (Central Meridian)

A zone width can also be defined. Points that exceed the zone width by 1° are not converted.

For a scale factor = 1 the cylinder is tangent to the sphere (ellipsoid), for a scale factor < 1 it is secant. Secant means the cylinder intersects the sphere along two straight lines equidistant from the central meridian. In this case the scale is true (1) along these two straight lines.

Oblique Mercator

Conformal Projection on to a cylinder. The cylinder is tangent to any circle other than the equator or a meridian. The Projection is defined by:

- False Easting and False Northing
- Latitude of Origin
- Central Meridian
- Angle (Type: Azimuth or Skew)
- Scale Factor at Origin

For a scale factor = 1 the cylinder is tangent to the sphere, for a scale factor < 1 it is secant. Secant means the cylinder intersects the sphere along two straight lines equidistant from the central meridian. In this case the scale is true along these two straight lines.

Universal Transverse Mercator (UTM)

Transverse Mercator Projection with fixed zone-defining constants. Thus it is sufficient to define:

- Zone Number (1-60)
- Hemisphere (north or south)

Zone-defining constants:

Origin: Intersection of equator and central meridian of each zone

Scale factor at central meridian: 0.9996

Zone width: 6° (3° east and 3° west of the central meridian)

Zone numbering: starting with number 1 for zone 180° west to 174° west and increasing eastwards

False Northing: 0 for northern hemisphere, 10'000'000 m for southern hemisphere

False Easting: 500'000 m

Note:

- The Central Meridian is selected automatically according to the selected Zone Number.
- Points, which exceed the zone width by 1° are not converted. (4° east and 4° west of the central meridian)

Cassini - Soldner

Projection on to a Cylinder. It is neither equal area nor conformal. The scale is true along the central meridian and along lines perpendicular to central meridian. The Projection is defined by:

- False Easting and False Northing
- Latitude of Origin
- Central Meridian

Lambert - one Standard Parallel

Conformal Projection on to a cone, with its axis coinciding with the z-axis of the ellipsoid, defined by:

- False Easting and False Northing
- Latitude of Origin
- Central Meridian
- Standard Parallel
- Scale Factor at Origin

If the Scale Factor at Origin = 1 the cone is tangent to the sphere (ellipsoid), if it is < 1 it is secant. Secant means the cone intersects the sphere along two parallel lines. In this case the scale is true along these two parallel lines.

Lambert - two Standard Parallels

Conformal Projection on to a cone, with its axis coinciding with the z-axis of the ellipsoid. The cone is secant to the sphere. The Projection is defined by:

- False Easting and False Northing
- Latitude of Origin
- Central Meridian
- First Standard Parallel
- Second Standard Parallel

Polar Stereographic

Conformal azimuthal Projection on to a plane. The point of Projection is on the surface of the sphere (ellipsoid) diametrically opposite of the origin (centre of the Projection). The Projection is defined by:

- False Easting and False Northing
- Latitude of Origin
- Central Meridian
- Scale Factor at Origin

If the Scale Factor at Origin = 1 the plane is tangent to the sphere (ellipsoid), if it is < 1 it is secant. Secant means the plane intersects the sphere along a circle. In this case the scale is true along this circle.

Double Stereographic

Conformal azimuthal Projection on to a plane. The point of Projection is on the surface of the sphere diametrically opposite of the origin (centre of the Projection). The Projection is defined by:

- False Easting and False Northing
- Latitude of Origin
- Central Meridian
- Scale Factor at Origin

If the Scale Factor at Origin = 1 the plane is tangent to the sphere, if it is < 1 it is secant. Secant means the plane intersects the sphere along a circle. In this case the scale is true along this circle.

Rectified Skewed Orthomorphic

This is a special type of **Oblique Mercator Projection**, defined by:

- False Easting and False Northing
- Latitude of Origin
- Central Meridian
- Angle Type (Azimuth or Skew)
- Rectify Type (Azimuth or Skew)
- Scale Factor at Origin

For a scale factor = 1 the cylinder is tangent to the sphere (ellipsoid), for a scale factor < 1 it is secant.

User defined projections

For Projections, which cannot be defined by the implemented standard Projections, the user can write his own program for a particular Projection.

The necessary input for the program has to be read from an ASCII file, the produced output has to be written to an ASCII file.

A Projection set accessing this user program can then be created by specifying the program's name and path:

Name

Name of the user defined Projection.

Path of EXE file:

Path and file name (including the extension .EXE). To select from the browser click .

Requirements for the user program:

- It must be an executable program.
- No interaction is allowed.
- Input and output for the user program has to be organised according to a specified [File Format](#) .

Related topics:

[Input / Output file format for User defined Map Projection](#)

[Example of a User-written Program](#)

File Format of INPUT.USR and OUTPUT.USR

Whenever Grid coordinates are converted to Geodetic coordinates or vice versa, intermediate files are created internally which are passed to the applied Projection program. In the case of a User-defined program, the programmer has to know the format of these intermediate files.

Input.usr

This is the file, which has to be accessed to read in the coordinates to be converted into the user defined map Projection program.

Line 1

Flag for identification of coordinate type:

1 = geodetic coordinates

2 = grid coordinates

Line 2

Semi-major axis of reference ellipsoid.

Line 3

Flattening of reference ellipsoid.

Following lines

Each line contains:

in case of geodetic coordinates: latitude and longitude (in radians) for one point.

in case of grid coordinates: easting and northing for one point.

Example of INPUT.USR file for geodetic coordinates:

```
1
6378137.000
0.003352810665
0.826317296827 0.167522411309
0.826317295438 0.167522411668
0.826317295735 0.167522412147
0.826317296574 0.167522411113
0.826317295208 0.167522411696
0.826317294691 0.167522410838
0.826317293977 0.167522410262
0.826317295626 0.167522410202
0.826317295911 0.167522411033
0.826317295738 0.167522410997
```

Example of INPUT.USR file for grid coordinates:

```
2
6378137.000
0.003352810665
763092.409 245766.864
763092.411 245766.855
763092.413 245766.857
763092.408 245766.862
763092.411 245766.854
763092.407 245766.850
763092.405 245766.845
763092.405 245766.856
763092.408 245766.858
```

```
763092.408 245766.857
```

Output.usr

This is the file into which the result of the Projection conversion, (i.e. the converted coordinates) has to be written.

All lines

Each line contains:

in case of grid coordinates output: easting and northing for one point.

in case of geodetic coordinates output: latitude and longitude (in radians) for one point.

Example of OUTPUT.USR file for grid coordinates:

```
763092.409 245766.864
763092.411 245766.855
763092.413 245766.857
763092.408 245766.862
763092.411 245766.854
763092.407 245766.850
763092.405 245766.845
763092.405 245766.856
763092.408 245766.858
763092.408 245766.857
```

Example of OUTPUT.USR file for geodetic coordinates:

```
0.826317296864 0.167522411279
0.826317295443 0.167522411684
0.826317295748 0.167522412158
0.826317296554 0.167522411036
0.826317295286 0.167522411677
0.826317294676 0.167522410728
0.826317293899 0.167522410235
0.826317295626 0.167522410305
0.826317295927 0.167522411010
0.826317295770 0.167522411004
```

Example of a User-written Program

The following example shows a User-written Program (written in Turbo Pascal) for the Swiss Projection. It transforms Swiss Grid coordinates to Geodetic coordinates (and vice versa). This map Projection is already included as a customized Projection.

The line numbers at the beginning of each line are for reference only. They do not constitute part of the source code.

```

001 Program CH_Projection_Set;
002
003 const
004 pi= 3.1415926535;
005 eps= 1.0e-10; {convergence limit}
006
007 {constants for Bessel ellipsoid}
008 ae= 6377397.155; {semi major axis}
009 ex2= 0.006674372231; {e squared}
010 lato= 46.952405556; {ell. latitude of Bern}
011 lono= 7.439583333*pi/180; {ell. longitude of Bern}
012
013 {derived constants for sphere}
014 r = 6378815.9036; {radius}
015 alpha = 1.00072913847; {scale factor along meridian through Bern}
017 rk = 0.00306673233; {integration constant}
018 bo= 46.907731456*pi/180; {spherical latitude of Bern}
019
020 var dummy: extended;
021 y,x,h,y1,x1: extended;
022 lquer,bquer,wert,wert1,wert2,bk,lk: extended;
023 cobo,sibo,cobi,sibi,coli,sili: extended;
024 ex,lati,loni,ritko: extended;
025 id: integer;
026 a,b: text;
027
028 {***** Main Program *****}
029
030 begin
031
032 {Assign and open files}
033
034 assign(a,'input.usr');
035 reset(a);
036 assign(b,'output.usr');
037 rewrite(b);
038
039 {Read the first 3 lines}
040
041 readln(a,id); {read type}
042 readln(a,dummy); {read semi-major axis, (not used, fixed programmed)}
043 readln(a,dummy); {read flattening, (not used, fixed programmed)}
044
045

```

```

046 if id = 1 then begin
047
048 {Transformation ELLIPSOID to GRID coordinates}
049
050 while not EOF(a) do begin
051 readln(a,lati,loni);
052
053 {transformation ellipsoid to sphere}
054 ex:= sqrt(ex2);
055 wert1:= pi/4.0+lati/2.0;
056 wert1:= alpha*ln(sin(wert1)/cos(wert1));
057 wert2:= ln((1.0+ex*sin(lati))/(1.0-ex*sin(lati)));
058 wert:= exp(wert1-(alpha*ex/2.0*wert2)+rk);
059 bk:= 2.0*(arctan(wert)-pi/4.0);
060 lk:= alpha*(loni-lono);
061
062 {transformation sphere to sphere}
063 cobo:= cos(bo);
064 sibo:= sin(bo);
065 cobi:= cos(bk);
066 sibi:= sin(bk);
067 coli:= cos(lk);
068 sili:= sin(lk);
069 wert1:= cobo*sibi-sibo*cobi*coli;
070 bquer:= arctan(wert1/(sqrt(1.0-wert1*wert1)));
071 lquer:= arctan(cobi*sili/(sibo*sibi+cobo*cobi*coli));
072
073 {transformation sphere to plane}
074 x1:= r/2.0*ln((1.0+sin(bquer))/(1.0-sin(bquer)));
075 y1:= r*lquer;
076
077 {transformation civil to military coordinates}
078 x:= x1+200000.0;
079 y:= y1+600000.0;
080
081 {output}
082 writeln(b,y:15:4,x:15:4);
083 end;
084 end;
085
086 if id = 2 then begin
087
088 {Transformation GRID to ELLIPSOID}
089
090 while not EOF(a) do begin
091 readln(a,y,x);
092
093 {transformation military to civil coordinates}
094 y1:= y-600000.0;
095 x1:= x-200000.0;
096
097 {transformation plane to sphere}

```

```
098 lquer:= y1/r;
099 bquer:= 2.0*(arctan(exp(x1/r))-pi/4.0);
100
101 {transformation sphere to sphere}
102 cobo:= cos(bo);
103 sibo:= sin(bo);
104 cobi:= cos(bquer);
105 sibi:= sin(bquer);
106 coli:= cos(lquer);
107 sili:= sin(lquer);
108 wert:= cobo*sibi+sibo*cobi*coli;
109 bk:= arctan(wert/(sqrt(1.0-wert*wert)));
110 lk:= arctan(cobi*sili/(cobo*cobi*coli-sibo*sibi));
111
112 {transformation sphere to ellipsoid}
113 ex:= sqrt(ex2);
114 lati:= bk;
115 repeat
116 ritko:= lati;
117 wert1:= pi/4.0+bk/2.0;
118 wert1:= sin(wert1)/cos(wert1);
119 wert1:= ln(wert1)/alpha;
120 wert2:= ln((1.0+ex*sin(lati))/(1.0-ex*sin(lati)))*ex/2.0;
121 lati:= 2.0*(arctan(exp(wert1+wert2-rk/alpha))-pi/4.0);
122 until (abs(ritko-lati)<eps);
123 loni:=lono+lk/alpha;
124
125 {output}
126 writeln(b,lati:15:12,loni:15:12);
127 end;
128 end;
129 close(a);
140 close(b);
141 end.
```

There are a few minor constraints in the user written program that must be observed in order to be able to integrate it into a user-defined Projection set:

LINE 034

The file name for the file containing the coordinates that are to be transformed (for grid coordinates as well as for geodetic coordinates) has to be INPUT.USR

LINE 036

The name of the file to output the transformed coordinates (for Grid coordinates as well as for Geodetic coordinates) has to be OUTPUT.USR

LINE 041

The first line of the INPUT.USR file containing the information flag for the type of coordinates is read in:
1 = geodetic coordinates.
2 = grid coordinates.

LINE 042

The second line of the INPUT.USR file containing the value for the semi-major axis of the reference ellipsoid is read in. In this example the value is not used because it is implicitly stated in the program parameters.

LINE 043

The third line of the INPUT.USR file containing the value for the flattening of the reference ellipsoid is read in. In this example the value is not used because it is implicitly stated in the program parameters.

LINE 046

The switch is set to transform from Geodetic to Grid coordinates.

LINE 051

The rest of the lines of the INPUT.USR file containing, in this case, Geodetic coordinates (latitude and longitude, in radians) are read in.

LINE 082

The resultant Grid coordinates are written to the OUTPUT.USR file. First Easting then Northing.

LINE 086

The switch is set to transform from Grid to Geodetic coordinates.

LINE 091

The rest of the lines of the INPUT.USR file containing, in this case, Grid coordinates (Easting and Northing) are read in.

LINE 126

The resultant Geodetic coordinates are written to the OUTPUT.USR file, first latitude then longitude (in radians).

State Plane Zones

State Plane Zones

The State Plane Zones are special predefined Projection zones used for the State Plane Coordinate System (SPCS) in North America. They are hardwired  and can neither be modified nor deleted.

State Plane Zones are available only if **North-America** has been selected in *Coordinate System Definitions* during installation.

Depending on the shape of a state, the zones have predefined Projection types and parameters associated with them.

The following Projection types are used for the State Plane Zones:

- Transverse Mercator (TM)
- Oblique Mercator
- Lambert - one Standard Parallel
- Lambert - two Standard Parallels

Tip:

- If you define a [Coordinate System](#) you may either use the configurable [Projections](#) or the [State Plane Zones](#). See also [How to switch between Projections and State Plane Zones](#).

See also:

[Properties of State Plane Zones](#)

State Plane Zone Properties

The State Plane Zone Properties are similar to the [Projection Properties](#). Since the State Plane Zones are pre-defined Projections none of the parameters may be edited.

How to switch between Projections and State Plane Zones

This function enables you to switch between selecting Map Projections or US State Plane Zones in the Coordinate Systems Property-Page.

- Right-click on the background of the Property-Page of a Coordinate System and select between **Projections** and **Zones**.

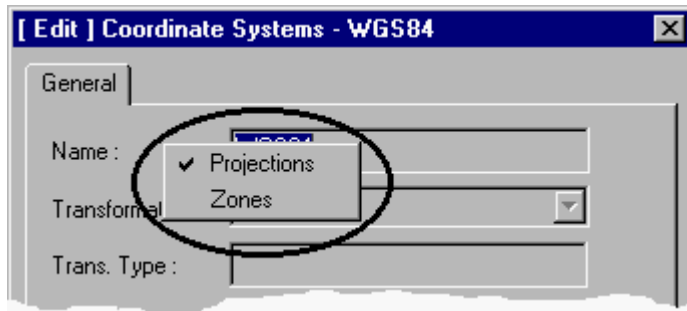

Geoid Models

Geoid Models

The user can utilise a Geoid Model that is appropriate for the mapping area under consideration. An Ellipsoid is attached to the Geoid Model. It is the user's responsibility to obtain the model, which will be in the form of an executable computer program. Geoid Models can be defined for Geodetic or Grid Coordinates and refer to a particular Ellipsoid.

With a Geoid Model attached to a Coordinate System you can [Compute Geoid Separations](#) of the Points in a Project. The Geoid Model replaces the requirement for you to manually input Geoid Separations for your points.

If Geoid Separations are available it enables you to switch between viewing *Ellipsoidal* and *Orthometric* heights. The relationship between *Ellipsoid* and *Orthometric* heights is given by:

Ellipsoidal Height (h) = Orthometric Height (H) + Geoid Separation (N)

Geoid Models may also be used on the receiver in the field. To do so you have to [Create a Geoid Model field file](#) and then upload the file to the receiver using the [Data Exchange Manager](#).

Note:

- Geoid Models are always an approximation of the actual Geoid. In terms of accuracy, they may vary considerably and in particular global models should be used with care. If the accuracy of the Geoid Model is not known it might be safer to use local control points with orthometric heights and apply a transformation to approximate the local geoid. The [Classical 3D Transformation](#) can be used in areas where the geoid has a regular shape, while the [Stepwise Transformation](#) is particularly suitable if the local geoid contains large variations within the mapping area.
- Geoid Models that are currently used in a Coordinate System are indicated by  and cannot be deleted.

Select from the index below to learn how to manage the Geoid Models:

[Add a New Geoid Model](#)

[Modify](#)

[Delete a Geoid Model](#)

[Save As](#)

[Geoid Model Properties](#)

Related Topics:

[How to write your own Geoid Model](#)

[Compute Geoid Separations](#)

[Create Geoid Model field file](#)

Add a New Geoid Model

1. Right-click on **Geoids** in the Tree-View and select **New**.
2. Enter the **Name** for the new Geoid Model.
3. Select the **Coordinate Type** (*Geodetic* or *Grid*) the Geoid Model shall be defined for. (For coordinate type *Geodetic with height scaling* see: Geoid models with height scaling.)
If the geoid model is defined using a GEM file, then the coordinate type is defined with the geoid model file.
4. Select the reference **Ellipsoid** which the model shall refer to.
If the geoid model is defined using a GEM file, then the ellipsoid is defined with the geoid model file.

Note: For the Geodetic geoid models which refer to the WGS84 ellipsoid you may select **Apply on the local side**. The geoid separations will then be applied after the transformation, i.e. to the local ellipsoidal heights.

5. Enter the **path** and name of the geoid model file. You can either select an executable file (*.exe) or a geoid model field file (*.gem). To select from the browser press 
6. Enter an optional **Note** to describe the Geoid Model.
7. Press **OK** to confirm or **Cancel** to abort the function.

Note:

- Geoid models can either be defined by an **executable file** or by a **geoid model field file**. For geoid models being defined by a field file the geoid separations required in your project are always kept up to date, whereas for geoid models being defined by an executable file it is necessary to manually **compute geoid separations**.

Refer to the topic [How to write your own Geoidal Model](#) for a description on how to create a geoid model executable file.

Refer to the topic [Create Geoid Model field file](#) on how to create a geoid model field file.

Delete a Geoid Model

1. Right-click on a Geoid Model in the Tree-View or Report-View and select **Delete**
2. Press **Yes** to confirm or **No** to exit without deleting

Note:

- Geoid Models that are currently used in a Coordinate System are indicated by  and cannot be deleted.

Geoid Model Properties

Geoid Model Properties

This Property-Sheet enables you to display/edit the Geoid Model Properties.

1. Right-click on a Geoid Model in the Report-View or Tree-View and select **Properties**.
2. Make your changes in the **General** page.
Note: Only the fields with white background may be edited at the particular instant.
3. If the Geoid model is defined from a *.gem file view the extents and spacing of the model in the **Extents** page.
4. Press **OK** to confirm or **Cancel** to abort the function.

Note:

- Geoid Models that are currently used in a Coordinate System are indicated by  and cannot be renamed but only modified.

Geoid Model Properties: General

This page enables you to display/edit the general Geoid Model Properties.

Name:

Name of Geoid Model. The Name can only be changed if the Geoid Model is not used in any Coordinate System definition.

Coordinate Type:

A Geoid Model may calculate Geoid separation values for either *Geodetic* or *Grid* Coordinates. Ask the provider of the Model for the required Coordinate Type. (For coordinate type *Geodetic with height scaling* see: Geoid models with height scaling.)

If the geoid model is defined using a GEM file, then the coordinate type cannot be changed.

Ellipsoid:

A Geoid Model is referenced to a particular Ellipsoid. Ask the provider of the Model for the correct Ellipsoid. If the geoid model is defined using a GEM file, then the ellipsoid cannot be changed.

Apply on the local side:

For the Geodetic geoid models which refer to the WGS84 ellipsoid you may select **Apply on the local side**. The geoid separations will then be applied after the transformation, i.e. to the local ellipsoidal heights. If the geoid model is defined using a GEM file, then the this option cannot be changed.

File path:

Path and file name (including the extension) of the geoid model. You can either select an executable file (*.exe) or a geoid model field file (*.gem). To select from the browser click .

Note:

Displays the optional Note to describe the Geoid Model. The Note may be up to 64 characters long.

Last Modified:

Displays the Date and Time the Geoid Model was last modified.

Note:

- Geoid models can either be defined by an **executable file** or by a **geoid model field file**. For geoid models being defined by a field file the geoid separations required in your project are always kept up to date, whereas for geoid models being defined by an executable file it is necessary to manually **compute geoid separations**.
- Geoid Models that are currently used in a Coordinate System are indicated by  and cannot be renamed but only modified.

Geoid Model Properties: Extents

This page enables you to display the extents of the Geoid Model.

South-west corner:

The coordinates of the lower left (South-west) corner of the model are displayed as local grid coordinates or geodetic coordinates depending on the Coordinate Type of the Geoid model.

North-east corner:

The coordinates of the upper right (North-east) corner of the model are displayed as local grid coordinates or geodetic coordinates depending on the Coordinate Type of the Geoid model.

Spacing:

The spacing of the grid is displayed according to the **Coordinate Type**.

How to write your own Geoid Model

The Geoid Model's purpose is to provide Geoid Separations (in meters) that are spatially referenced either in terms of Grid or Geodetic coordinates.

When developing such a model there will be a data file of Geoid Separations that are ordered either on a regularly spaced grid or in some other way (i.e., in an irregular pattern). A computer program can then be written that will read from the database, perform some kind of spatial interpolation, and thus estimate the Geoid Separation at any specific point within the area covered by the model.

In LGO the requirement is for the Geoid Model to output "Interpolated Geoid Separations" that coincide with the locations of points that exist in the Local Grid (or Geodetic) coordinate systems.

It is the user's responsibility to either write, or obtain, a program that will serve as the Geoid Model. Certain guidelines must be followed — they are somewhat similar in nature to those that apply for [User defined Projections](#).

Requirements for the user-defined Geoid Model:

- It must be an executable program.
- No interaction is allowed.
- Input for the user program has to be organised according to the specified file format given below.
- Input, output and external data files have to be accessed from the current directory.

Input into the Geoid Model

When a user-written geoidal model is "called" by the Office software a file called "INPUT.USR" will automatically be prepared. This file contains all the points for which the executable program has to interpolate the geoidal undulation values. The format of such a file is shown below:

For Geodetic coordinates (Latitude, Longitude) in radians:

```
0.826317296827 0.167522411309
0.826317295438 0.167522411668
```

etc.

For Grid coordinates (Easting, Northing) in meters:

```
763092.4093 245766.8641
763092.4112 245766.8552
```

etc.

The Geoid Model must read in the coordinate file and then perform its interpolation and preparation of the Geoid Separation values for each point contained in the "INPUT.USR" file.

Note:

- In this case the order Easting/ Northing will not be affected by switching the coordinate order under [Tools – Options](#) . This has to be taken into account when designing the executable program.

Output from the Geoid Model

The Geoid Model must then write its values to a file called "OUTPUT.USR." This file is a free-format file that contains no header information. The only additional requirement regarding the format of this file is that the Geoid Separations (in meters) must be written in the first column of the file. For Geoid Models of Coordinate Type *Geodetic* or *Grid* any additional information (i.e., column 2, column 3 etc.), which is written to the file, will be ignored by LGO. Each column must be separated by at least one blank space.

Geoid Models of Coordinate Type *Geodetic with height scaling* can be used to correct the geoid separations with a height dependent scale factor. In this case the output file must contain two columns in each line, which are separated by at least one blank space. The first value is interpreted as the separation and the second value as a scale factor correction.

Note:

- If a geoid separation bigger than 500 meters is written to the OUTPUT.USR file, the geoid separation will not be displayed in your project. Such values can be used to mark areas, where the geoid model is invalid.

Compute Geoid Separations

This command enables you to compute Geoid Separations for the points in a Project if a Geoid Model is defined in the Coordinate System used. It replaces the requirement for you to manually input Geoid Separations for your points.

This command is only required if your **geoid model** is defined by an **executable file**. If your geoid model is defined by a **geoid model field file** then the geoid separations of your project are always calculated automatically.

1. Make sure a Geoid Model is defined in the Coordinate System attached to your Project.
2. Open the Project for which you want to compute Geoid Separations.
3. From the **Tools** menu select **Compute Geoid Separations**. A Geoid Separation will be calculated and stored for each Point.

Note:

- If the Geoid Model you are using is defined for local Grid coordinates, make sure a Coordinate System with the appropriate Map Projection is attached to your Project.
- If you are using a regional Geoid Model that is defined for a certain area only, make sure the points of the Project are located within this area.
- In View/Edit it is also possible to display contour lines of the geoid for the extents of your project. Please refer to [Graphical Settings: View](#).

Related Topic:

[Geoid Model](#)

Create Geoid Model field file

Geoid Models may also be used on the receiver in the field. This command enables you to create a Geoid Model field file.

Geoid models usually consist of a geoid height grid where a Geoid Separation is defined for each grid point. Depending on the extent and the grid spacing of the Geoid Model it may require considerable disk space. In order to use the Geoid Model on a GPS sensor the disk space has to be reduced and a special field file has to be created which will allow the field system to interpolate Geoid Separations.

This command enables you to extract a Geoid height grid from an existing Geoid Model for a particular area. The area boundary can be defined by a rectangle or circle and a grid spacing in meters can be selected. The file can then be uploaded to the receiver using the [Data Exchange Manager](#).

1. From the **Tools** menu select **Create Geoid Model field file...**
2. Select a Geoid Model from the list or click on **View** and [Add a New Geoid Model](#).
3. Select the **Interpolation method** which shall be used when interpolating in the Geoid Model field file. You can choose between Bi-quadratic, Bi-linear and Spline interpolation methods. Select **Default (for System 500)** if you have to create a Geoid Model field file for a System 500 instrument or for a System 1200 instrument which runs a firmware older than Version 4.0.
4. Select the method to define the limits of the Geoid Model field file. Select between **Centre & radius** and **Extents**.
5. Enter the Coordinates of the **Center point**, the **Radius** and the Grid **Spacing**
or
enter the Coordinates of the **South-west** and **North-east** corner and the Grid **Spacing**. The order of the coordinates will appear in accordance with the order set under [Tools – Options – General page](#).
6. Check the **File size**. If you wish to use the file on the System RAM it must not exceed a certain size.
Note: The maximum possible file size may vary depending on the free memory in the receivers system RAM. Refer to the Technical Reference Manual on how to free system RAM of the receiver.
7. Click on **Save**.
8. From the browser select the path where the file shall be created.
9. Enter a **File name** without extension. (Extension "gem" will be added automatically)
10. Click on **Save** to confirm.
Note: Depending on the file size, this may take a while.

Related Topic:

[Geoid Model](#)

CSCS Models

CSCS Models

Several countries have produced tables of conversion factors to directly convert between GPS measured coordinates given in WGS84 and the corresponding local mapping coordinates, taking the distortions of the mapping system into account. Using these tables it is possible to directly convert into the local grid system without having to calculate your own transformation parameters. **Country Specific Coordinate System Models (CSCS Models)** are an addition to an already defined coordinate system, which interpolates corrections in a grid file and applies the interpolated corrections. The extra step of applying these corrections can be made at different instances in the coordinate conversion process. Therefore different methods of CSCS Models are supported.

Conversion Methods:

- **Grid conversion method:** When selecting a CSCS Model of method **Grid**, then -when converting from WGS84 to Local Grid- first the transformation, map projection and ellipsoid specified will be applied to get preliminary grid coordinates. As an extra step a shift in Easting and Northing will be interpolated in the grid file of the CSCS Model resulting in the final local Easting and Northing.
- **Cartesian conversion method:** When selecting a CSCS Model of method **Cartesian**, then -when converting from WGS84 to Local Grid- after the specified transformation a 3D-shift will be interpolated in the grid file of the CSCS Model resulting in Local Cartesian coordinates upon which the specified local ellipsoid and map projection will be applied to get final local Easting and Northing.
- **Geodetic conversion methods** are also possible. When selecting a CSCS Model of method **Geodetic**, then -when converting from WGS84 to Local Grid- a shift in geodetic latitude and longitude will be interpolated in the grid file of the CSCS Model resulting in final local geodetic coordinates to which the map projection is applied.
- **Ellipsoidal conversion methods** work similar to the Geodetic conversion method. This method also applies a shift in geodetic latitude and longitude but at a different step in the coordinate conversion process. When converting from WGS84 to Local Grid first the transformation and the ellipsoid specified will be applied to get preliminary local geodetic coordinates. As an extra step a shift in latitude and longitude will be interpolated in the grid file of the CSCS Model resulting in the final local geodetic coordinates to which the map projection is applied.

CSCS Models may also be used on the receiver in the field. To do so you have to [Create a CSCS Model field file](#) and then upload the file using the [Data Exchange Manager](#).

Certain CSCS Models are pre-defined and hardwired in the Office software. They are already connected to the corresponding grid file. These CSCS Models are:

OSTN02™ (Great Britain)
 OSTN97™ (Great Britain)
 GR3DF97A (France)
 ETRS89-RD (Netherlands)
 Jylland/ Sjælland/ Bornholm (Denmark)
 SWEREF99RT90 (Sweden)
 NZGD49-2000 (New Zealand)
 NADCON (U.S.A.)

Models for which the correction files have to be purchased are also supported. It may be necessary to convert the files to the LGO specific binary CSC file format. For more information see: [Other CSCS Models](#).

Note:

- CSCS Models that are currently used in a Coordinate system are indicated by  and cannot be deleted.
- If coordinates which fall outside the area covered by the CSCS model are to be converted then the CSCS model is ignored.

Related topics:

[CSCS Model Properties](#)

[Create CSCS Model field file](#)

Add a new CSCS Model

1. Right-click on CSCS Models in the Tree-View and select **New**.
2. Enter the **Name** of the CSCS Model.
3. Enter path and name of the grid file or press  to select from the browser.
The *Method*, *Interpolation method* and the *Coordinate type* will be displayed if a valid CSCS file has been selected.
4. Enter the optional **Note** to describe the CSCS Model.
5. Press **OK** to confirm or **Cancel** to abort the function.

Delete a CSCS Model

1. Right-click on a CSCS Model in the Tree-View or Report-View and select **Delete**
2. Press **Yes** to confirm or **No** to exit without deleting

Note:

- CSCS Models that are currently used in a Coordinate System are indicated by  and cannot be deleted.

CSCS Model Properties

CSCS Model Properties

This Property-Sheet enables you to display/ edit the CSCS Model Properties.

1. Right-click on a CSCS Model in the Report-View or Tree-View and select **Properties**.
2. Make your changes in the **General** page.
Note: Only the fields with white background may be edited.
3. View the extents and spacing of the model in the **Extents** page.
4. Press **OK** to confirm or **Cancel** to abort the function.

Note:

- CSCS Models that are currently used in a Coordinate System are indicated by  and cannot be renamed but only modified.

CSCS Model Properties: General

This page enables you to display/ edit the general CSCS Model Properties.

Name:

Name of the CSCS Model. The Name can only be changed if the CSCS Model is not used in any Coordinate System definition.

Path of Grid file:

Path and file name (including the extension .csc). To select from the browser click .

Method:

Displays the Conversion method of the **CSCS Model**. The Conversion method can be either Grid shifts, Geodetic shifts or Cartesian shifts. It is pre-defined by the CSCS Model Grid file.

Interpolation Method:

Displays the Interpolation method used to interpolate a correction value in the grid file. The Interpolation method is pre-defined by the CSCS Model Grid file.

Coord. Type:

Displays the Coordinate type with respect to which the grid file is given. The Coordinate type is defined by the CSCS Model Grid file.

Note:

Displays the optional Note to describe the CSCS Model. The Note may be up to 64 characters long.

Last modified:

Date and Time at which the CSCS Model was last modified.

Note:

- CSCS Models that are currently used in a Coordinate System are indicated by  and cannot be renamed but only modified.

CSCS Model Properties: Extents

This page enables you to display the extents of the CSCS Model.

South-west corner:

The coordinates of the lower left (South-west) corner of the model are displayed as local grid coordinates or geodetic coordinates depending on the Coordinate Type of the CSCS model.

North-east corner:

The coordinates of the upper right (North-east) corner of the model are displayed as local grid coordinates or geodetic coordinates depending on the Coordinate Type of the CSCS model.

Spacing:

The spacing of the grid is displayed according to the **Coordinate Type**.

Create CSCS Model field file

CSCS Models may also be used on the receiver in the field. This command enables you to create a CSCS Model field file.

1. From the **Tools** menu select **Create CSCS Model field file...**
2. Select a CSCS Model from the list or click on **View** and [Add a New CSCS Model](#).
3. Select the method to define the limits of the CSCS Model field file. Select between **Centre & radius** and **Extents**.
4. Enter the Coordinates of the **Center point** and the **Radius**
or
enter the Coordinates of the **South-west** and **North-east** corner. The order of the coordinates will appear in accordance with the order set under [Tools – Options – General page](#).
5. Check the **File size**. If you wish to use the file on the System RAM it must not exceed a certain size.
Note: The maximum possible file size may vary depending on the free memory in the receivers system RAM. Refer to the Technical Reference Manual on how to free system RAM of the receiver.
6. Click on **Save**.
7. From the browser select the path where the file shall be created.
8. Enter a **File name** without extension. (Extension "csc" will be added automatically)
9. Click on **Save** to confirm.
Note: Depending on the file size, this may take a while.

Related Topic:

[CSCS Models](#)

Antenna Management

Antenna Management

A GPS baseline consists of the vector between the phase center of two GPS antennas. Each antenna type (brand, model) has its own phase center offset. This is especially noticeable if baselines are processed using mixed GPS antennas.

The phase center offset of different antennas varies especially in terms of a height difference between the L1 and L2 phase center. The difference in position usually is negligible.

The Antenna Management enables you to manage the phase center offsets for different GPS antennas. The offsets are then applied as corrections during the baseline processing.

The phase center offsets are defined relative to a [Reference Antenna](#). The reference antenna is a **Dorne-Margolin Type T** choke ring antenna.

All Leica antennas have been calibrated against the reference antenna and the relative offsets are already hardwired in the Office software. Thus if you are using Leica antennas only, the appropriate corrections are applied automatically and the user is not required to make any changes in the Antenna Management tool.

Normally, the antenna type is set on the receiver in the field. If you download GPS raw data, the appropriate antenna type is also downloaded to the project. If you want to assign a different antenna type to your GPS raw data [Drag and Drop](#) the appropriate antenna type from the Antenna Management to the [Antennas View](#) of the Project and then set the new antenna type using the [Interval Properties](#) of the Data Processing View.

To start the Antenna Management proceed as follows:

- From the Tools menu, select Antenna Management or click on  in the **Tools** List Bar.

Select from the list below to learn more about Antenna Management:

[Add a New Antenna](#)

[Modify](#)

[Delete an Antenna](#)

[Import Antenna file](#)

[Send To](#)

[Antenna Properties](#)

Related topics:

[Reference Antenna for phase center offsets](#)

[Antenna Height Reading](#)

[Antennas View of a Project](#)

Add a New Antenna

Enables you to add a new antenna in order to define the offsets and corrections.

1. From the Context-menu (right-click) select **New...**
2. Enter a **Name**.
3. Optionally enter the **IGS name** and a **Setup Id**. Set the **L1-only** flag if required.
4. Enter **Horizontal offset** and **Vertical offset**.
5. Enter the **Phase center offsets**.
6. Optionally enter the **Additional corrections**.
7. Press **OK** to confirm or **Cancel** to abort the function.

Note:

- Depending on the setup you are using the Vertical and Horizontal Offsets may be different. Create a new antenna for each setup you are using. See also [Antenna Height Reading](#).
- The combination of IGS name, Serial number and Setup Id must be unique for each antenna.

Delete an Antenna

1. Right-click on the antenna to delete and select **Delete**.
2. Select **Yes** to confirm or **No** to abort without deleting.

Note:

- The Leica antennas  are hardwired and can not be deleted.

Import Antenna file

This function enables you to import an antenna calibration file in the Bernese or in the NGS or in the ANTEX format. These files are available from **AIUB** (Astronomical Institute University of Bern) or from NGS (National Geodetic Survey) and contain a list of different antenna types with its respective offsets and eccentricities.

1. From the Context-menu (right-click) select **Import Antenna file...**
2. From the browser select a file.
3. In NGS antenna files antenna names may contain a four-digit suffix for the antenna dome. Check the corresponding box if you wish this suffix to be included in the name which will be imported into LGO.
4. Press **Open** to store the data in the Office database or **Cancel** to abort the function.

Note:

- Antenna calibration data is available from **NGS** (National Geodetic Survey) under the following Internet address: <http://www.ngs.noaa.gov/ANTCAL/>
- If you are using external calibration data ensure that they refer to the **Dorne/Margolin choke ring antenna type T**. See also [Reference Antenna for phase center offsets](#).

Antenna Properties

Antenna Properties

This Property-Sheet enables you to display and/or modify the antenna properties.

1. Right-click on an antenna in the Report-View and select **Properties**.
2. In the **General** page make your changes.
If you are using **Additional corrections** use the tab to switch.
3. Press **OK** to confirm or **Cancel** to abort the function.

Antenna Properties: General

Name:

Name of Antenna i.e. brand and type.

IGS name:

Optional IGS name which will be used for RTCM V3.0 transmission.

Serial number:

Optional.

Setup Id:

Optional.

Horizontal offset:

Horizontal distance from the physical reference point to the point on the antenna where the slope height reading is measured to.

Note: If you are using vertical height readings (Height Hook) this value may be 0. See also [Antenna Height Reading](#)

Vertical offset:

Vertical distance from the physical reference point to the point where the height reading is measured to.

Note: If you are using slope height readings to a point above the physical reference plane this value must be negative. See also [Antenna Height Reading](#)

Phase center offsets for L1 and L2

Vertical:

Vertical distance from the physical reference plane to the virtual phase center for L1 and L2 frequency.

North:

Horizontal distance from the physical reference point to the virtual center in North direction for L1 and L2 frequency.

East:

Horizontal distance from the physical reference point to the virtual center in North direction for L1 and L2 frequency.

Additional corrections:

Allows you to select between **Elevation and Azimuth** and **Spherical harmonics**. See also [Additional corrections](#).

Antenna Properties: Additional corrections

A GPS antenna does not have a single well-defined phase center. Instead, the phase center is a function of the direction from which it receives a signal. This is known as the phase center variation. For highest accuracy the phase center variations can be defined using the Additional corrections.

Almost all GPS antennas currently in use are azimuthally symmetric to a high degree, however azimuth dependency can also be modelled.

The parameters for the phase center variation may be described using two different models. If either **Elevation and Azimuth** or **Spherical harmonics** was selected on the General page you can display or edit the additional corrections.

Elevation and Azimuth

If *Elevation and Azimuth* was selected you can enter phase center corrections for both frequencies at regular elevation and azimuth intervals. Select the elevation and azimuth interval and enter the phase center corrections in millimeters by double-clicking into the values of the table.

For azimuthally symmetric antennas or when azimuth dependency is unknown select an azimuth interval of 360 degrees.

For defining L1 corrections only click the corresponding button on the page.

Spherical harmonics

If *Spherical harmonics* was selected you can enter the coefficients for the development of the phase center variations into spherical harmonics. Select degree and order of the development and enter the coefficients by double-clicking into the values of the table.

Check the box on the page to enter the coefficients of a normalized development.

For defining L1 corrections only click the corresponding button on the page.

Note:

- If the L1-only flag is checked in the [Antenna Properties: General](#) page then only L1 corrections can be defined.

Reference Antenna for phase centre offsets

The reference antenna used for calibration measurements is the **Dorne/Margolin choke ring antenna type T**. The physical reference point on the antenna is the bottom of the pre-amplifier housing.

Phase center offset for L1: East = 0.0 mm; North = 0.0 mm; Up = 110.0 mm
Phase center offset for L2: East = 0.0 mm; North = 0.0 mm; Up = 128.0 mm

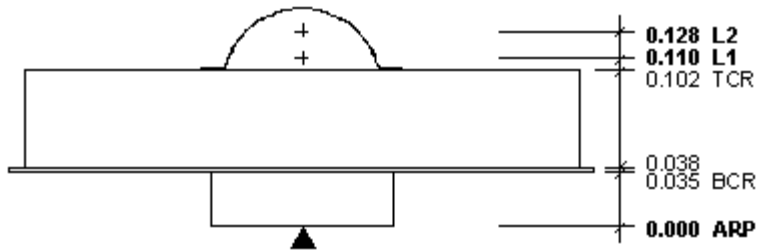

Antenna Height Reading

The pictures below show two different ways the height of a GPS antenna can be measured. On the left the height is determined by measuring the slope distance to an offset point on the antenna. On the right the height is measured by using a height hook.

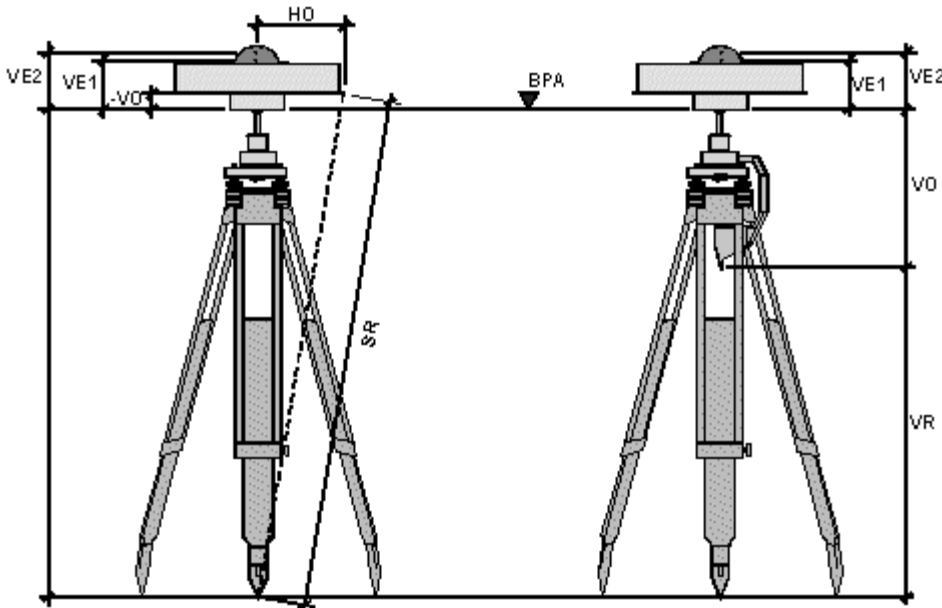

HO = Horizontal Offset

VO = Vertical Offset

VR = Vertical Height Reading

SR = Slope Height Reading

VE1 = Vertical Phase Center Eccentricity for L1

VE2 = Vertical Phase Center Eccentricity for L2

BPA = Physical Reference Plane (bottom of pre-amplifier)

If you are using the **Slope Height Reading** the antenna height is calculated as follows:

$$\text{Antenna Height} = \sqrt{\text{SR}^2 - \text{HO}^2} \pm \text{VO}$$

Note: If the Offset Point on the antenna is above the Physical Reference Plane **BPA**, the Vertical Offset **VO** is negative!

If you are using a **Height Hook** the Antenna height is as follows:

$$\text{Antenna Height} = \text{VR} + \text{VO}$$

The actual Heights of the **Phase Centers** are then calculated as follows:

$$\text{Height of Phase Center L1} = \text{Antenna Height} + \text{VE1}$$

$$\text{Height of Phase Center L2} = \text{antenna height} + \text{VE2}$$





Codelist Management

Codelist Management

The Codelist Management enables you to create Codelists that will work with Leica Instruments.

A Codelist contains coding information that may be used to describe topographical features and points during measurement in the field.

If you import raw data with a Codelist attached into LGO, the Codelist will be stored within a Project and is accessible via the Codelist View.

A  Codelist may contain  **Thematical codes** and / or  **Free codes**. A *SmartWorx* advanced codelist may also contain  **Line** and  **Area codes**.

A Codelist consists of three building blocks within its structure:

Code Groups:

The primary building block of a Codelist is known as **Code Groups**. One or more Code Groups may be contained within a Codelist. A Code Group will usually describe a large group of objects such as *Buildings*, *Vegetation* etc.

Codes:

Codes are the secondary building block of a Codelist and may be definite features. For example, a Code Group called *Vegetation* could have the codes *Tree*, *Shrub* and *Hedge*. Alternatively, the Codes could consist of numbers only with a Code Name describing the code. E.g. code 145 could relate to the code name *Tree*.

Attributes:

Each Code may have one or more **Attributes** attached to it. Attributes are the tertiary building block of a Codelist. Attributes prompt the user to enter information describing a Code.

For example, the code *Tree* could have the attributes *Diameter*, *Species*, *Height*, and *Remark* attached to it. You may then define an Attribute Value for an Attribute. It may be chosen from a predefined **Choice List** or a predefined **Range**. For example, possible Values for the Attribute *Diameter* could be from a **Range** from 1 to 25 (meters) and the Attribute *Species* from a **Choice List** that contains the Values *Pine*, *Fir*, and *Oak*.

Note that you do not have to define an Attribute Value within Codelist Management. If no value is defined for an Attribute you may enter a value or description in the field.

A Codelist can be uploaded to a Sensor or downloaded from a Sensor using the **DXM** (Data Exchange Management) tool.

Select from the list below to learn more about Codelist Management:

[Create a New Codelist](#)

[Delete a Codelist](#)

[Print a Codelist](#)

[Register](#)

[Send To](#)

[Codelist Properties](#)

[Codelist Structure](#)

Code Group

Code

Attributes

Codelist

Codelist Structure

This example shows a Codelist structure as displayed in the Tree-View. The element properties (Codelist, Code Group, Code and Attribute properties) as displayed in the Report View can be viewed by clicking on the elements or via the context menu.

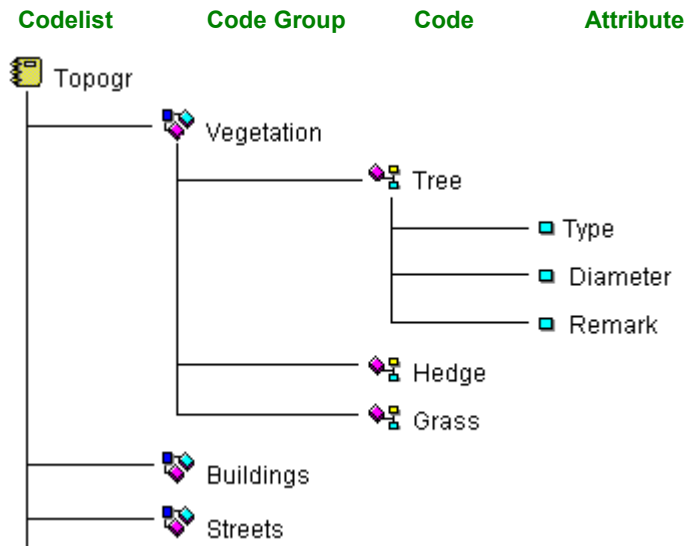

See also

[Example - Codelist](#)

[Example - Code Group](#)

[Example - Code](#)

[Example - Attribute](#)

Codelist View

The Codelist View of a Project lists all the Codes that have been used in the field. Upon importing raw data the used Codes are automatically transferred to the Project database and can be modified in this View.

- The Codelist View may be accessed via the  **Codelist** Tab from within a project window.

Note:

- See [Point Properties: Thematical Data](#) on how to change the Thematical Codes of individual Points of a Project database.

Select from the list below to learn more about the Codelist View:

[Print a Codelist](#)

[Codelist Properties](#)

[Codelist Structure](#)

[Code Group](#)

[Code](#)

[Attributes](#)

Codelist Type

Codelist Type

For each **Instrument class** you have the choice between *Basic* and *Advanced* Codelist Types. For instrument class TPS 1100 you additionally have the choice between GSI-8 and GSI-16 codelist types. The Codelist Type defines the complexity of the Codelist.

The Codelist Type defines:

- which types of Codes are possible (thematical or free or Lines/Area codes)
- if Short Cuts for Quick Codes are supported
- if Code descriptions can be entered
- if Code Groups can be used
- to which extent Attributes are user configurable.

The following Codelist Types are available. Click on any of the different **Instrument classes** for more information on how the respective Codelist Type is defined:

Instrument class	Codelist Types
DNA	Basic Advanced
GPS 500	Basic Advanced
GPS 900	Basic
SmartWorx	Basic Advanced
TPS 1100	Basic (GSI-8) Basic (GSI-16) Advanced (GSI-8) Advanced (GSI-16)
TPS 300	Basic Advanced
TPS 400	Basic Advanced
TPS 700	Basic Advanced
TPS 800	Basic Advanced
TS02/06/09	Basic

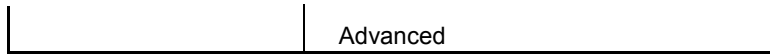

Codelist Type DNA

If you select DNA as your Instrument class you have the choice between *Basic* and *Advanced*.

A *Basic* codelist is defined by:

- Only Thematical Codes are allowed.
- Code descriptions cannot be entered.
- Short cuts for Quick Codes are allowed.
- Code Groups cannot be defined.
- Attribute types are fixed to *Normal*, the Value type is fixed to *Text* and the Value region is fixed to *None*.
- Attribute names are pre-defined ranging from *Info 1* to *Info 8*.

An *Advanced* codelist is defined by:

- Only Thematical Codes are allowed.
- Code descriptions can be entered.
- Short cuts for Quick Codes are allowed.
- Code Groups cannot be defined.
- For Attributes the Value region is fixed to *None*.

Codelist Type GPS 500

If you select GPS 500 as your Instrument class you have the choice between *Basic* and *Advanced*.

A *Basic* codelist is defined by:

- Only Free Codes are allowed.
- Code descriptions can be entered.
- Short cuts for Quick Codes are not allowed.
- Code Groups cannot be defined.
- Attribute types are fixed to *Normal* and the Value type is fixed to *Text*.
- Attribute names are pre-defined ranging from *Info 1* to *Info 8*.

An *Advanced* codelist is defined by:

- Free Codes and Thematical Codes are allowed.
- Code descriptions can be entered.
- Short cuts for Quick Codes are not allowed.
- Code Groups can be defined.
- Attributes are fully user-configurable.

Codelist Type GPS 900

If you select GPS 900 as your Instrument class the Type will be set to *Basic*.

The *Basic* codelist is defined by:

- Only Point (Thematical) Codes and Free Codes are allowed.
- Code descriptions can be entered.
- Short cuts for Quick Codes can be entered (up to three alphanumeric characters).
- Code Groups cannot be defined.
- Attributes are fully user-configurable.
- Attribute names are pre-defined ranging from *Attrib1* to *Attrib4*.

Codelist Type SmartWorx

If you select SmartWorx as your Instrument class you have the choice between *Basic* and *Advanced*.

A *Basic* codelist is defined by:

- Only Free Codes are allowed.
- Code descriptions can be entered.
- Short cuts for Quick Codes can be entered (up to three alphanumeric characters).
- Code Groups cannot be defined.
- Attribute types are fixed to *Normal*, the Value type is fixed to *Text* and the Value Region is fixed to *None*.
- Attribute names are pre-defined ranging from *Attrib1* to *Attrib8*.

An *Advanced* codelist is defined by:

- Free and Point (Thematical) Codes are allowed as well as Line and Area Types.
- Code descriptions can be entered.
- Short cuts for Quick Codes can be entered (up to three alphanumeric characters).
- Code Groups can be defined.
- Attributes are fully user-configurable.

Codelist Type TPS 1100

If you select TPS 1100 as your Instrument class you have the choice between *Basic (GSI-8)*, *Basic (GSI-16)* and *Advanced (GSI-8)*, *Advanced (GSI-16)*.

A *Basic* codelist is defined by:

- Only Free Codes are allowed.
- Code descriptions can be entered.
- Short cuts for Quick Codes are allowed.
- Code Groups cannot be defined.
- For Attributes the Value type is fixed to *Text* and the Value region is fixed to *None*.

An *Advanced* codelist is defined by:

- Free Codes and Thematical Codes are allowed.
- Code descriptions can be entered.
- Short cuts for Quick Codes are allowed.
- Code Groups cannot be defined.
- Attributes are fully user-configurable.

Note:

- The difference between *GSI-8* and *GSI-16* is the number of characters supported for Attribute names, i.e. either 8 or 16 characters are supported.

Codelist Type TPS 300/ 400/ 800, TS02/06/09

If you select TPS 300 or TPS 400 or TPS 800 or TS02/06/09 as your Instrument class you have the choice between *Basic* and *Advanced*.

A *Basic* codelist is defined by:

- Only Thematical Codes are allowed.
- Code descriptions cannot be entered.
- Short cuts for Quick Codes are not allowed.
- Code Groups cannot be defined.
- Attribute types are fixed to *Normal*, the Value type is fixed to *Text* and the Value region is fixed to *None*.
- Attribute names are pre-defined ranging from *Info 1* to *Info 8*.

An *Advanced* codelist is defined by:

- Only Thematical Codes are allowed.
- Code descriptions can be entered.
- For TPS 300 and TPS 400 Short cuts for Quick Codes are not allowed.
For TPS 800 and TS02/06/09 Short cuts for Quick Codes are allowed.
- Code Groups cannot be defined.
- For Attributes the Value region is fixed to *None*.

Codelist Type TPS 700

If you select TPS 700 as your Instrument class you have the choice between *Basic* and *Advanced*.

A *Basic* codelist is defined by:

- Only Thematical Codes are allowed.
- Code descriptions cannot be entered.
- Short cuts for Quick Codes are allowed.
- Code Groups cannot be defined.
- Attribute types are fixed to *Normal*, the Value type is fixed to *Text* and the Value region is fixed to *None*.
- Attribute names are pre-defined ranging from *Info 1* to *Info 8*.

An *Advanced* codelist is defined by:

- Only Thematical Codes are allowed.
- Code descriptions can be entered.
- Short cuts for Quick Codes are allowed.
- Code Groups cannot be defined.
- For Attributes the Value region is fixed to *None*.

Instrument Classes

Depending on which Leica instrument the Codelist is used, the format of the Codelist may vary slightly. Currently the following instrument classes are supported:

- DNA
- GPS 500
- GPS 900
- SmartWorx
- TPS 1100
- TPS 300
- TPS 400
- TPS 700
- TPS 800
- TS02/06/09

For each instrument class you have the choice between *Basic* and *Advanced Codelist Types*. For instrument class TPS 1100 you additionally have the choice between GSI-8 and GSI-16 Codelist Types.

SmartWorx codelists can be used on all instruments running the SmartWorx firmware onboard. This includes System 1200 (GPS and TPS), GPS 900, the TS30/ TM30 and the Leica Viva series instruments.

Create a new Codelist

1. In the Tree-View or in the Report-View right-click and select **New Codelist...**
2. Enter a **Codelist Name** and a **Location** where the *.CRF file shall be stored on your harddisk. The **File Name** is generated automatically according to the given Codelist Name.
3. Enter the **Creator** of the Codelist. This entry is optional.
4. In the **Codelist Type** field of the dialog choose an **Instrument Class** and a Codelist **Type**.
5. Press **OK** to confirm or **Cancel** to abort the function.

Note:

- The **Codelist Type** cannot be changed after a codelist is created.

Delete a Codelist

To delete a Codelist:

1. In the Tree-View or in the Report View right-click on a  **Codelist** and select **Delete**.
2. Press **OK** to confirm or **Cancel** to exit without deleting.

Related topics:

[Delete a Code Group](#)

[Delete a Code](#)



[Delete an Attribute](#)

Print a Codelist

Before printing a Codelist you may want to check and modify the [Print Setup](#).

You can either print the various Codelist Management Report Views separately or you can create an all-in-one graphical report-style printing showing Code Groups, Codes and Attributes (including Choice Lists) in one printout.

To print a Codelist in the graphical report-style overview:

1. In the Tree-View select a  Codelist.
2. From the **File** main menu select **Print Preview** or select  from the toolbar.
3. From the **File** main menu select **Print** or select  from the toolbar.

[Example:](#)

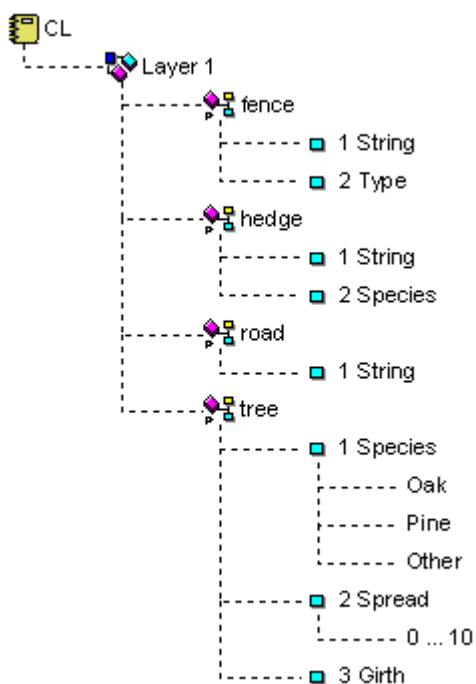

To print a single Codelist Management Report View:

- In the Tree-View or in the right-hand Report View right-click and select **Print** from the context menu.

[Alternatively:](#)

If the focus is in the right-hand Report View you may also select  **Print** from the **File** main menu or from the toolbar to print the active Report View.

[Example:](#)

Attributes of Code tree of Layer Layer 1 of Codelist CL

Attribute Name	Attribute Type	Value Type	Value Region	Default Value
1 Species	Normal	Text	Choice List	None
2 Spread	Normal	Integer	Range	None
3 Girth	Normal	Text	None	None

Register a Codelist

The list of Codelists is updated constantly. This is done automatically when you work within the Office environment. The Codelists will normally always be registered.

You can, of course, use the Windows Explorer, e.g. to copy a Codelist from one PC to another manually or you can copy codelists from the database of the field system to your PC manually. If you do so, this Codelist will not be registered automatically.

In this case use **Register...** to link Codelists that are on the hard disk but not shown in the Codelist Management, to the Office database.

1. In the Tree View or in the Report View right-click and select **Register...**
2. From the browser select the directory containing the Codelist to be registered. In the **Name** combo box **all** Codelists found in the selected directory are listed.
3. From the **Name** combo box select the **specific** Codelist to be registered.
4. Press **OK** to confirm or **Cancel** to abort the function.

Note:

- You can also register a codelist from an IDEX file. Browse to the *.idx file. In addition the Codelists which may be contained in the selected directory all IDEX files will be displayed in the **Name** combo box.

When registering a codelist from an IDEX file, the codelist will be converted to the Office database format, but the IDEX file will be retained. Subsequent changes to the codelist in the office software will not apply to the original IDEX file. It will not be updated simultaneously.

Unregister a Codelist

The **Codelist Management** lists all codelists that are registered in the Office database. If you wish to remove a codelist from the list without deleting it select **Unregister** from the context-menu.

To unregister a codelist:

1. In the Tree View or in the Report View right-click on the codelist to be unregistered.
2. Select **Unregister**.

Unregistered Codelists can be linked back to the list of codelists by **registering** them again.

Note:

- To unregister more than one codelist at once select a series of codelists and right-click onto the selected block to unregister the codelists.

Codelist Properties

To view or modify the Codelist Properties:

1. Right-click on a  Codelist in the Tree-View or in the Report View and select **Properties...**
2. In the Codelist Properties dialog you may change:
 - the **Codelist Name**. The file name will be adapted accordingly.
 - the **Location** where the Codelist shall be stored.
 - the **Creator** of the Codelist.

The **Codelist Type** is defined during the creation of the codelist and may not be modified later.
3. Press **OK** to confirm or **Cancel** to abort the function.

Example - Codelist

This example shows possible properties of the Codelist *Topogr* as displayed in the Report View.

	<u>Codelist Name</u>	<u>Creator</u>	<u>Location</u>	<u>File Name</u>	<u>Template</u>
	Topogr	XXX	C:\temp	topogr.crf	GPS500_Advanced

See also

[Example - Code Group](#)

[Example - Code](#)

[Example - Attribute](#)

Code Group

Code Group

 Code Groups describe groups of objects, which have a common theme. A Codelist may contain as many or as few Code Groups as you wish. For example, *Utilities*, *Vegetation*, *Buildings* could all be different Code Groups within a Codelist. Each Code Group then has sub-components known as **Codes** and **Attributes**. Possible Code Groups and their properties can be viewed in an [example](#).

You can easily **add** or **insert** new Code Groups, **modify** existing Code Groups and **delete** Code Groups. Within a Codelist all existing Code Groups can be set visible or invisible by changing the [Code Group Display](#).

If no Code Group is selected all Codes will be placed in a default Code Group. Code Group names may be up to 16 characters long and may consist of alphanumeric characters.

Note:

- Code Groups are only available if the [Instrument class](#) is *GPS 500* or *SmartWorx* and if the [Codelist Type](#) is *Advanced*.

Select from the list below to learn more about Code Groups:

[Add a New Code Group](#)

[Delete a Code Group](#)

[Code Group Properties](#)

[Display Code Group](#)

[Example - Code Group](#)

Add a New Code Group

To add a new Code Group to the end of a Codelist:

1. Right-click on the  Codelist to which you want to add a new Code Group in the Tree View or right-click anywhere in the corresponding Report View and select **New Code Group...** from the context menu.
2. Enter a new **Code Group Name**. A Code Group name may be up to 16 characters long.
3. Press **OK** to confirm or **Cancel** to abort the function.

To insert a new Code Group in between existing Code Groups:

1. In the Tree-View or in the Report View right-click on the  Code Group right before which you want to insert a new Code Group and select **New Code Group...** from the context menu.
2. Enter a new **Code Group Name**. A Code Group name may be up to 16 characters long.
3. Press **OK** to confirm or **Cancel** to abort the function.

Note:

- Code Groups are only available if **Instrument class** is *GPS 500* or *SmartWorx* and **Codelist Type** is *Advanced*.

Delete a Code Group

To delete a Code Group from a Codelist:

1. In the Tree-View or in the Report View right-click on the  Code Group to be deleted and select **Delete**.
2. Press **OK** to confirm or **Cancel** to exit without deleting.

Note:

- If you delete a Code Group all Codes and Attributes of that Code Group will be deleted.

Code Group Properties

To view or modify the Properties of a Code Group:

1. In the Tree-View or in the Report View right-click on a  Code Group and select **Properties**.
2. Change the **Code Group Name**. A Code Group name may be up to 16 characters long.
3. Press **OK** to confirm or **Cancel** to abort the function.

Alternatively:

- Edit the Code Group name in the Report View via inline editing.

Note:

- Code Groups are only available if **Instrument class** is *GPS 500* or *SmartWorx* and **Codelist Type** is *Advanced*.

See also:

[Add a new Code Group](#)

Display Code Group

Existing Code Groups can be set visible or invisible in the Tree-View. To change the current status of the Code Group View:

- Right-click in the background of the Tree-View pane and click on **Display Code Group** to change the status. A means that the Code Groups will be displayed.



If the Code Groups are switched off all codes appear to be merged in the codelist.

Note:

- Even if the Code Group View is switched off all Code Group information will be kept.
- If the Code Group View is switched off new Codes will be placed on a Code Group called *Default*.

Example - Code Group

This example shows possible Code Groups within the Codelist *Topogr*. The Code Group properties are shown as displayed in the Report View.

	<u>Code Group Name</u>
	Vegetation
	Buildings
	Streets

See also

[Example - Codelist](#)

[Example - Code](#)

[Example - Attribute](#)

Code

Code

 Codes are contained within [Code Groups](#) and can be used to describe objects. For example, the Codes *Tree*, *Hedge*, *Grass* may be attached to a Code Group entitled *Vegetation*.

You can easily **add** or **insert** new Codes, **modify** existing Codes and **delete** Codes.

Each Code may have [Attributes](#) attached to it. Attributes prompt the user to enter further information about the Code.

A Code consists of the Code Name, an optional Code Description, a Type and an optional Short Cut for a Quick Code. Possible Codes and their properties can be viewed in an [example](#).

Code

The name of the Code may be up to 8 characters long and may consist of numbers or alphanumeric characters (for example *Tree*). For SmartWorx the Code Name may be up to 16 characters long.

Description

The Description of a Code may be up to 16 characters long (for example *Outstanding Tree*). The Description of a Code is optional. For System 500 the description may be up to 30 characters long.

Type

The Type of a Code can either be *Free* (Free Coding) or *Point* (Thematical Coding). For SmartWorx two additional Code Types are available: Lines and Areas. For detailed information on which Code Types are available with the different instrument classes and codelist types see: [Codelist Type](#).

Quick Code

The Short Cut for a quick code may consist of a two digit number to describe the Code (for example *12*). For SmartWorx codelists up to three alphanumeric characters are allowed. Quick codes must be unique within a codelist. To define a quick code is optional. For detailed information on the instrument classes for which quick codes can be defined see: [Codelist Type](#).

Select from the list below to learn more about Codes:

[Add a New Code](#)

[Delete a Code](#)

[Properties of a Code](#)

[Example - Code](#)

Add a new Code

To add a new Code to a Codelist:

1. Right-click on the  Code Group to which you want to add the new Code in the Tree View or in the corresponding Report View and select **New Code...** from the context-menu.

If the display of Code Groups is **switched off** or if the **Codelist Type** does not support Code Groups right-click on the  **Codelist** to which you want to add the new Code.
If Code Groups are switched off the new Code will be placed in a Code Group called **Default**.
2. Enter a new **Code**.
The name of a Code may be up to 8 characters long (16 characters for SmartWorx) and may consist of alphanumeric characters.
If the **Codelist Type** supports Short Cuts for **Quick Codes** then you may optionally enter a 2 or 3 digit Quick Code.
3. Enter the optional **Description**.
A Description may be up to 16 characters long (30 characters for GPS 500) and may consist of alphanumeric characters.
4. Enter the **Type**.
Select between *Free* and *Point*. The availability of *Free* and/ or *Point (Thematical)* Codes depends on the **Codelist Type**.
For SmartWorx advanced codelists you may additionally select between *Line* and *Area*. For both additional properties, like border and shading styles, can be defined.
Also for SmartWorx advanced codelists you can assign the *Linework* option to Point codes. For details see: [Code Properties](#).
5. Press **OK** to confirm or **Cancel** to abort the function.

To insert a new Code in between existing Codes:

1. In the Tree-View or in the Report View right-click on the  **Code** right before which you want to insert a new Code and select **New Code...** from the context menu.

If the display of Code Groups is **switched off** the new Code will be inserted into the same underlying Code Group as the following code belongs to.
2. Enter the new Code Properties.
3. Press **OK** to confirm or **Cancel** to abort the function.

Delete a Code

To delete a Code from a Codelist:

1. In the Tree View or in the Report View right-click on a  Code and select **Delete**.
2. Press **OK** to confirm or **Cancel** to exit without deleting.

Note:

- If you delete a Code all Attributes of this Code will be deleted.

Code Properties

To view or modify a Code:

1. In the Tree-View or in the Report View right-click on a  Code and select **Properties**.
2. In the Code Properties dialog you may change:
 - the **Code Name**.
 - the **Code Description**.
 - the **Type** (either Point or Free).
 - the Short Cut for a **Quick Code**.

For SmartWorx advanced codelists you may also set the **Code Type** to either Line or Area. For both these types additional properties can be entered:

- for Type **Line** define the *Line Style*, *Color* and *Width*. The settings can be pre-viewed in the **Line/ Border** column of the corresponding Report View.
- for Type **Area** define the *Border Style*, *Color* and *Width* as well as the *Shading Style* and *Color*. The Border settings can be pre-viewed in the **Line/ Border** column of the corresponding Report View, the Shading settings in the **Area Shading** column.

For SmartWorx advanced codelists Point codes can have the additional **Linework** properties. If you select **Start Line** or **Start Area** in the Linework combo-box and use the codelist onboard a SmartWorx instrument, a line or area will be opened automatically when this code is assigned to a point. The graphical elements for these lines or areas (border and shading style/ color/ width) can be selected additionally for such codes.

Note: The linework option can only be used onboard a SmartWorx instrument, if you are using Firmware version 5.0 or higher.

For more details on the single code properties see: [Code](#).

3. Press **OK** to confirm or **Cancel** to abort the function.

Alternatively:



- Edit the Code Properties in the Report View via inline editing.

See also:

[Add a new Code](#)

Example - Code

This example shows possible Codes within the Code Group *Vegetation*. The Code properties are shown as displayed in the Report View.

	<u>Code Name</u>	<u>Code Description</u>	<u>Quick Code</u>	<u>Type</u>
	Tree	Outstanding Tree	11	Point
	Grass	Area of Grass	20	Free
	Hedge	Hedge	37	Point

See also

[Example - Codelist](#)

[Example - Code Group](#)

[Example - Attribute](#)

Attribute

Attribute

Attributes are the tertiary building block of a Codelist. Attributes prompt the user to enter information describing a Code. Attributes for the Code *Tree* could be *Species*, *Diameter* and *Remark*. You can easily **add** or **insert** new Attributes, **modify** existing Attributes or **delete** Attributes.

An Attribute generally consists of Attribute Name and Type and the Attribute Value with a defined Value Type, an optional Value Region and a Default Value. Possible Attributes and their properties can be viewed in an [example](#).

Attribute Name:

The Attribute Name may consist of alphanumeric characters (for example *Species*). The length depends on the [codelist type](#).

Attribute Type:

For every Attribute the Type must be chosen. Possible Attribute Types are *Normal*, *Mandatory* or *Fixed*. Choosing *Normal* means the Attribute Value can be edited in the field. If *Mandatory* is chosen, the Attribute Value must be edited in the field. If the Attribute type is *Fixed*, no Value is shown on the instrument and the Default Value will automatically be attached to the Attribute.

Value Type:

For every Attribute a Value Type must be selected. Possible Value Types are *Text*, *Real* or *Integer*. If you choose *Real* or *Integer* you have the possibility of entering a Choice List or a Range of possible Values. If you choose *Text* possible Values may only be entered in a Choice List. For example for the Attribute *Species* choose *Text*, whereas for the Attribute *Diameter* choose *Integer* as the Value Type.

Value Region:

Depending on the chosen Value Type you can select the Value Regions *None*, *Choice List* or *Range*. In a *Choice List* all possible Values can be entered, in a *Range* the smallest and the largest possible Value can be entered. For example for the Attribute *Species* choose *Choice List*, for *Diameter* choose *Range*, and for *Remark* choose *None*.

Attribute Values:

If **Choice List** is chosen a list of possible Attribute Values can be entered or modified. For example *Oak*, *Pine* and *Fir* could be possible Choice List entries for the Attribute *Species*.

To add new Values to the Choice List press the **Add** button.

To remove Values from the Choice List press the **Delete** button.

To modify the sequence of the values in the Choice List press the **Move Up/ Move Down** buttons.

If **Range** is chosen the Range interval can be entered or modified. For example, for the Attribute *Diameter* a Range from 1 to 5 (meters) could be defined.

Note: The number of characters allowed depends on the [codelist type](#).

Default Value:

Setting a Default Value is optional. If *Choice List* or *Range* is selected for Value Region a Value from the Choice List or within the Range can be entered. For *Fixed* Values a Default Value should be entered otherwise no Attribute Value will be set at all.

Select from the list below to learn more about Attributes:

[Add a new Attribute](#)



[Delete an Attribute](#)

[Properties of an Attribute](#)





[Example – Attribute](#)

Add a new Attribute

To add a new Attribute to a Codelist:

1. Right-click on the  Code to which you want to add the new Attribute or on one of the existing  Attributes in the Tree View or in the corresponding Report View and select **New Attribute...** from the context menu.
2. Enter the **Attribute Name**. The Attribute name may consist of numbers or alphanumeric characters. The length depends on the **codelist type**.
3. Select the **Attribute Type** from the list. Choose between *Normal*, *Mandatory* or *Fixed*. If you select *Fixed* the Default Value will be attached automatically to this Attribute and the Value will not be shown on the instrument. If you select *Mandatory* the Value must be edited in the field.
4. Select the **Value Type** from the list. Select between *Text*, *Real* or *Integer*.
5. Select the **Value Region** from the list. If the Value Type is set to *Real* or *Integer* you have the choice between *Choice List* and *Range*. If the Value Type is set to *Text* only *Choice List* can be chosen.
6. Depending on your selection in Value Region enter either the Values for the *Choice List* or the Values for the *Range*:

Choice List: Click on:

- the  **Add** button to add a new Value and press **Enter**.
- the  **Delete** button to delete a Value from the list.
- the  **Move Up** button to move a Value one position up in the list.
- the  **Move Down** button to move a Value one position down in the list.

Range: Enter the Range interval **From** and **To**.

7. Enter the **Default Value**. If you have previously defined a *Choice List* or *Range* you may choose the Default Value from the list or Range. Entering the Default Value is optional. If the Attribute Type is *Fixed* a Default Value needs to be entered.
8. Press **OK** to confirm or **Cancel** to abort the function.

To insert a new Attribute in between of existing Attributes:

1. In the Tree-View or in the Report View right-click on the  Attribute right before which you want to insert a new Attribute and select **New Attribute...** from the context menu.
2. Enter the Attribute properties.
3. Press **OK** to confirm or **Cancel** to abort the function.

Note:

- Depending on the **Codelist Type** certain restrictions for the definition of attributes may apply.

Delete an Attribute

To delete an Attribute from a Codelist:

1. In the Tree View or in the Report View right-click on an  Attribute and select **Delete**.
2. Press **OK** to confirm or **Cancel** to exit without deleting.

Attribute Properties

To view or modify the Attribute Properties:

1. In the Tree-View or in the Report View right-click on an  Attribute and select **Properties**.
2. Change Attribute Name and Parameters as required. See also [Add a new Attribute](#).
3. Press **OK** to confirm or **Cancel** to abort the function.

Alternatively:

- Edit the Attribute name in the Report View via inline editing.

Example - Attribute

This example shows possible Attributes within the Code *Tree*. The Attribute properties are shown as displayed in the Report View.

	<u>Attribute Name</u>	<u>Attribute Type</u>	<u>Value Type</u>	<u>Value Region</u>	<u>Attribute Values</u>	<u>Default Value</u>
■	Species	Normal	Text	Choice List	Pine Oak Fir	Pine
■	Diameter	Mandatory	Integer	Range	...	6
■	Remark	Normal	Text	None		

See also

[Example - Codelist](#)

[Example - Code Group](#)

[Example - Code](#)

Value Types - Examples (Coding)

This Table shows examples for the three Attribute Value Types:



<u>Value Type</u>	<u>Text</u>	<u>Real</u>	<u>Integer</u>
Examples:	Pine	34.5	1
	Tree001	-543.463	-24
	Oak	23	438

Satellite Availability

Satellite Availability

The **Satellite Availability** tool helps you to plan your GPS field work. It provides you with graphical and numerical information on the satellite constellation for any location (Site) at a given time.

To start the Satellite Availability component:

- From the **Tools** menu select  **Satellite Availability** or click on  **Satellite Availability** within the **Management** List Bar. The Satellite Availability component opens and offers the following two tabbed views:

Management:

In the  **Management** tabbed view you can define the input data needed for determining the availability of satellites at a given time:

- Define **new Sites** or view the **properties** of existing **Sites**.
- **Import** new Almanacs or delete existing ones. Almanacs are automatically added during GPS raw data import.
- Define a **new** set of **Obstructions** or view the **properties** of existing **Obstructions**, **import Obstructions** from a file or **export Obstructions** to a file.

Availability:

In the  **Availability** tabbed view you can graphically inspect the satellite constellation at a given time for a given Site.

- Select a **Site**, **Almanac** and **Obstruction** file to determine the availability.
- See a **Skyplot** or inspect the **DOPs** for all healthy satellites, or inspect the **Elevation**, **Azimuth** and **Visibility** for single satellites.

To get a numeric output of the results open the Satellite Availability **Report**.

For detailed information see also:

[Satellite Availability Management](#)

[Calculating Satellite Availability](#)

Management

Satellite Availability: Management

In the **Management** view of the Satellite Availability component **Sites**, **Almanacs** and **Obstruction** files are managed.

Sites:

Define the Survey Sites for which you want to determine the satellite availability. **New** Sites can be entered and existing Sites can be edited via the [Site Properties](#).

Almanacs:

To compute the satellite availability for a specific Site, Almanac information has to be provided. During the import of GPS raw data, almanac files are automatically stored into the Office database. But Almanacs can also be manually [imported](#).

By default, the **Availability** component will always use almanac information with a date closest to the selected **Date** and **Time**. Nevertheless, the user may wish to manually select an older almanac for use in survey preparations. Older almanacs that are no longer required can also be **deleted** from the database.

Obstructions:

Define the site-specific Obstructions. Obstructions may be defined for Rover and Reference. A **new** Obstruction file can be generated graphically in the lower right-hand view. Double-click into the sky representation to generate a new obstruction point (e.g. the top of a building). In the upper right-hand report view you will find the numeric values (**Azimuth** and **Elevation**) for each graphically entered point.

A set of Obstructions may also be [exported](#) to a file once it is defined in LGO. You can also [import](#) obstructions from a file instead of defining them graphically in LGO.

To modify graphically defined obstruction values right-click into the upper report view and select **Modify ...** from the context menu to adapt the values.

Sites, **Almanacs** and **Obstructions** are needed as input data to the [Availability](#) calculation.

Tip:

- New Sites can easily be defined by copying & pasting points from a project into the  **Sites** report view. Points must have WGS84 coordinates and more than one point may be copied at a time. The number of newly created sites will correspond to the number of copied points. The name(s) of the Site(s) will correspond to the Id(s) of the copied point(s).

See also:

[Site Properties](#)

[Import Almanacs](#)

[Obstruction Properties](#)

[Create a new Obstruction](#)

[Import Obstructions](#)

[Export Obstructions](#)

Site Properties

The **Site Properties** may be defined for each new Site and modified for existing Sites in the **Management** view of the **Satellite Availability** component.

Name:

Enter a name for a Site to be newly defined or modify the name of an existing Site.

Description:

Optionally enter a description of the Site.

Region:

Optionally enter a region in which the Site is located.

Latitude/ Longitude/ Height:

Enter the WGS84 Latitude, Longitude and Height of a Site to be newly defined or modify the values of existing Sites.

Time Zone:

Enter or modify the Time Zone in which the Site is located. The entered value will be applied to the availability calculation.

Last Modified:

Shows the Date and Time when the Site has last been modified.

Tip:

- New Sites can easily be defined by copying & pasting points from a project into the  **Sites** report view. Points must have WGS84 coordinates and more than one point may be copied at a time. The number of newly created sites will correspond to the number of copied points. The name(s) of the Site(s) will correspond to the Id(s) of the copied point(s).

Import Almanacs

During the import of GPS raw data into LGO, almanac files are automatically stored into the database. But Almanacs can also be **manually** imported.

Almanacs may manually be imported from **System 200** (*.alm files), from **System 300** or **500** (*.o?? files) or from **SmartWorx** (*.m?? files) raw data files.

Apart from that **YUMA** almanacs (*.yum*. * files) may be downloaded from the Internet via the [Internet Download](#) functionality or manually from <http://www.navcen.uscg.gov>. A description of the YUMA almanacs is available from <http://www.navcen.uscg.gov/GPS/gpsyuma.htm>.

YUMA almanacs which are extended for the GLONASS and the Galileo satellite systems are available from Leica Geosystems.



To manually import Almanacs:

1. In the **Management** view of the Satellite Availability component right-click on  **Almanacs** and select **Import...** from the context menu.
2. In the **Import Alamanc** dialog browse to the directory where the Alamanc(s) to be imported are stored.
3. Select the Almanac(s) to be imported and press the **Import** button.
Check **Include subfolders** and select a directory if you wish to import automatically the Almanacs of the selected directory and all sub-directories.

The newly imported Almanac(s) will be added to the list of Almanacs in the tree-view.

Create a new Obstruction

In the **Management** view of the Satellite Availability component **new** sets of obstructions may be **graphically** created.

1. In the tree-view right click on  **Obstructions** and select **New...** from the context menu.
2. In the **New Obstruction** dialog enter a **Name** for the new obstruction and optionally a **Description**.
3. Leave the dialog with **OK**. The new obstruction will be added to the list of **Obstructions** in the tree-view.
4. In the tree-view open the  **Obstructions** node and click onto the  new obstruction. The right-hand view changes:
In the upper report view two empty columns appear which will be filled with the **Azimuth** and **Elevation** values of each new obstruction point that you create graphically in the lower part.
In the lower part an empty skyplot appears into which obstruction points may be entered graphically.
5. In the skyplot double-click to enter a new obstruction point at its specific **Azimuth** and **Elevation**.
Alternatively right-click into the skyplot at the Azimuth and Elevation where the new point shall be added and select **New** from the context menu.

The new point will be added to the list in the upper report view. To change the Azimuth and/ or Elevation values of an obstruction point right-click on the value to be changed in the report view and select **Modify...** from the context menu.

New obstruction points can only be entered graphically. When all points have been entered the line that connects the obstruction points will be closed automatically.

- To delete obstruction points right-click onto the point in the graphic and select **Delete** from the context menu. A point may also be deleted from within the report view.

The set of obstructions is stored while it is created and may be used in the **Availability** view for calculating the satellite availability.

Import Obstructions

Sets of Obstructions may be imported from a text file into the Satellite Availability component. This text file must have a specific **Obstruction file format**.

1. In the tree-view of the **Management** view right-click onto  **Obstructions** and select **Import...** from the context menu
2. In the **Import Obstruction** dialog browse to the directory where the obstruction file to be imported is stored.
3. Select the file and press the **Import** button.
Check **Include subfolders** and select a directory if you wish to import automatically the Obstruction files of the selected directory and all sub-directories.

The newly imported Obstructions will be added to the list of Obstructions in the tree-view.

Export Obstructions

Sets of Obstructions that have been **created** in the Satellite Availability component may be exported for further use.

1. In the tree-view of the **Management** component open the  **Obstructions** node and right-click on the set of obstructions to be exported.
2. From the context menu select **Export...**
3. In the **Save as** dialog browse to the directory where the set of obstructions shall be saved and enter a **File name**.
4. Press save to save the set of obstructions.

The set of obstructions will be saved in a specific **Obstruction file format** to a text file.

Obstruction file format

This format is used to **save** sets of Obstructions to a text file or to manually write Obstruction files which shall later be **imported** to the **Satellite Availability** component.

The file must have one column with horizontal angle readings and one column with vertical angle readings.

At the beginning of each file the following header information must be available:

@%Pointid: 16 characters for a point identifier (obstruction name)

@%Unit: The angular units may be measured in gon or decimal degrees. For gon enter "400", for decimal degrees enter "360".

@%OrientationHz: An unknown orientation (the azimuth of the horizontal zero reading of the theodolite) can be entered. In case that the theodolite has already been oriented in the field, the value "0" has to be entered. When exporting obstructions always an orientation of zero will be used.

@%OrientationV: Enter "elevation" for elevation readings. When importing obstructions with zenith angle values enter "zenith". The values will be converted to elevations during import.

Example:

```
@%Pointid: Town1
@%Unit: 360
@%OrientationHz: 0.000
@%OrientationV: elevation
  6.859  16.199
 40.898  18.031
 46.674  31.752
 80.823  13.427
120.210  13.510
134.597  16.210
147.047  32.667
```

Note:

The values for elevation and azimuth can be integer or real numbers.

Obstruction Properties

The **Obstruction Properties** may be defined for each new set of Obstructions and modified for existing sets of Obstructions in the **Management** view of the **Satellite Availability** component.

Name:

Enter a name for a set of Obstructions to be newly defined or modify the name of an existing set of Obstructions.

Description:

Optionally enter a description for the set of Obstructions.

Last Modified:

Shows the Date and Time when the set of Obstructions has last been modified.

See also:

[Create a new Obstruction](#)

Availability

Satellite Availability: Availability

According to the selected Almanac and taking into account the site-specific obstructions, the availability of healthy satellites in the selected Site will be computed for the selected time span and graphically displayed in the right-hand pane of the view.

Illustration:

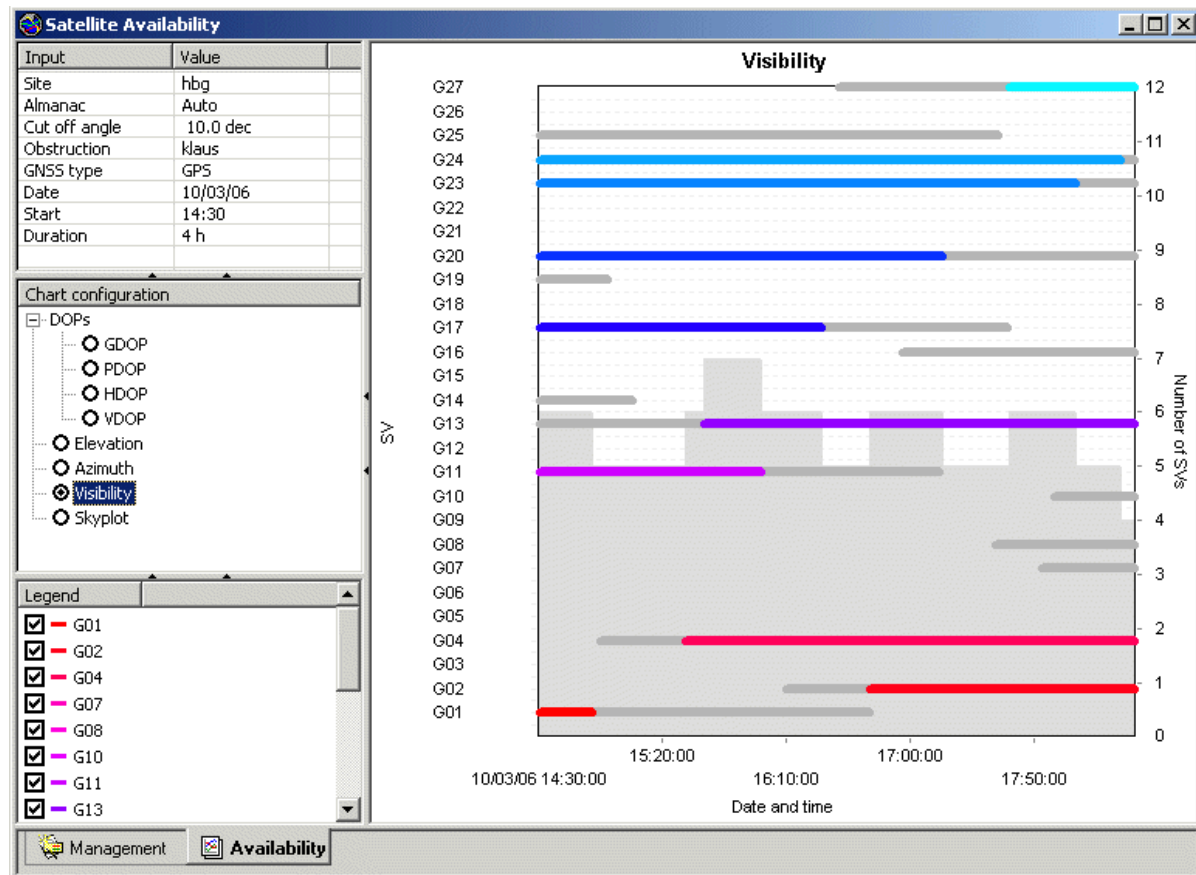

Input data:

- Via in-line editing (**Modify...**) select the **Site** for which you want to calculate the availability of satellites. You may select from the list of Sites as defined in the **Management** component.
- Select an **Almanac**. By default, the Almanac with its date closest to the selected **Date** and **Time** will be selected **automatically**. You may select a different Almanac from the list of Almanacs as given in the **Management** component. Note that the date of the almanac must not differ more than 30 days from the selected date.
Further note that almanacs containing combined GPS and GLONASS information may have slightly varying validities for the two GNSS systems.
- Define a **Cut-off Angle**, below which satellites will not be used.
- Select the site-specific set(s) of **Obstructions**. For Rover and Reference you may select from the list of Obstructions as defined in the **Management** component. For the Availability computation the obstructions as defined for Rover **and** Reference will be taken into account.

- Select the type of satellites (**GNSS type**) to be used for the calculation. If the selected almanac contains GLONASS satellites or if **Automatic** almanac selection was chosen then you can choose between a combination of the **GPS**, **GLONASS** and **Galileo** satellite systems. Changing the GNSS type resets all de-activated satellites.
- Select a **Date**, for which you want to determine the availability of satellites. Determine a **Start** time and the **Duration** of your planned field work.

Chart configuration:

The right-hand chart may be configured to show either:

- **DOPs**: the selected kind of DOP value is graphically displayed as it is computed for the selected period of time.
- or **Elevation**: the Elevation of each satellite, i.e. how high a satellite is above the horizon, is graphically displayed. Satellites underneath the **Cut-off Angle** or behind **Obstructions** are sketched in outlines.
- or **Azimuth**: the Azimuth values, i.e. the direction into which a satellite may be found in the sky, are graphically displayed for each satellite along the selected period of time. Satellites underneath the **Cut-off Angle** or behind **Obstructions** are sketched in outlines.
- or **Visibility**: the time slot when a satellite is 'visible' for the receiver is graphically indicated by a colored bar for each satellite. Satellites underneath the **Cut-off Angle** or behind **Obstructions** are displayed with grey bars.
- or **Skyplot**: the Skyplot summarizes the Azimuth and Elevation values for each satellite in a 2D representation of the sky. It shows how the satellites move along the sky.

The **DOP**, **Elevation**, **Azimuth** and **Visibility** charts all show in a light grey color the number of satellites at each point of time in the background of the charts.

To differentiate the satellites from each other they are color coded in a **Legend** underneath.

Legend:

The Legend lists all satellites which are visible in the selected period of time. Healthy satellites are checked , unhealthy satellites remain unchecked. You may manually exclude satellites from the availability calculation by de-activating them in the Legend. Changing the satellite selection enforces a recalculation of the DOP values.

For use in the Elevation, Azimuth, Visibility and Skyplot charts each satellite is color coded in the Legend.

Note:

- The Satellite Availability charts can be [copied to the clipboard](#) or can be [saved to a file](#) using the context-menu inside the chart.

The results of the Availability computation may also be inspected in:

[Satellite Availability Report](#)

Satellite Availability Report

To get an overview on the Satellite Availability calculation and its results you may invoke the **Satellite Availability Report**.

- In the **Availability** tab right-click into a chart and select **Open report** from the context menu.

The report opens in a stand-alone window and is listed in the **Open Documents** list bar.

Stand-alone reports can be saved as HTML files or printed:

- To save a report as an HTML file right-click inside the report and select **Save As...**
- To print a report right-click inside the report and select **Print**. A **Print Preview** is also available from the context menu.
- To select the **contents** and the **format** of the report right-click and select **Properties...** from the context menu or click  in the **Reports** toolbar. For further details refer to: [Configure a Report](#).

When the report has been configured to display all possible sections it presents you with the following information:

- General Information
- Obstructions
- Obstruction Graphics
- Satellites/ DOP
- Satellites/ DOP Graphics

General Information:

This section of the report lists the **Site** that has been selected for the Availability calculation together with its **Properties**. The **Date**, **Almanac**, **Cut-off Angle** and **Obstruction** that have been selected as **Input data** to and subsequently been used in the Availability calculation are listed underneath.

All healthy **Satellites** that are visible in the given Site at the given period of time are listed as well as the manually **Disabled** (de-activated) satellites.

Obstructions:

The **Name(s)** of the Obstruction(s) that have been selected as **Input data** to the Availability calculation are listed together with their Azimuth/ Elevation tables. If no Obstructions have been selected this section of the report will not show up.

Azimuth and **Elevation** of each Obstruction point are listed in each table.

Obstruction Graphics:

A graphical representation of all Obstruction(s) that have been used in the Availability computation is shown to illustrate the table(s) given in the **Obstructions** section of the report. The graphical representation in the report corresponds to the **Obstructions** graphics as defined in the **Management** tab.

You can **Zoom In** or **Out** or **Copy** the graphics to another application.

Satellites/ DOP

[Illustration:](#)

Satellites / DOP values

Time	No. of satellites	GDOP	PDOP	Satellites
10/03/06 14:30	10	2.8	2.3	G01, G11, G17, G20, G23, G24, R03, R04, R18, R19
10/03/06 14:40	10	2.9	2.3	G01, G11, G17, G20, G23, G24, R04, R05, R18, R19
10/03/06 14:50	10	3.0	2.4	G01, G11, G17, G20, G23, G24, R04, R05, R18, R19
10/03/06 15:00	8	6.7	5.2	G11, G17, G20, G23, G24, R04, R05, R19
10/03/06 15:10	8	7.3	5.7	G11, G17, G20, G23, G24, R04, R05, R19
10/03/06 15:20	8	6.7	5.3	G11, G17, G20, G23, G24, R04, R05, R19
10/03/06 15:30	9	3.0	2.5	G04, G11, G17, G20, G23, G24, R04, R05, R19
10/03/06 15:40	10	2.3	1.9	G04, G11, G13, G17, G20, G23, G24, R04, R05, R21
10/03/06 15:50	10	2.3	2.0	G04, G11, G13, G17, G20, G23, G24, R04, R05, R21
10/03/06 16:00	9	3.4	2.8	G04, G13, G17, G20, G23, G24, R04, R05, R21

For the selected Date and Time, for which the availability of satellites has been computed, the **No. of Satellites**, various **DOPs** and the **Satellite IDs** are listed at fixed intervals of 10 minutes. Using the [Report Template Properties](#) you can decide which DOP values shall be displayed.

Satellites/ DOP Graphics

[Illustration:](#)

Satellites / DOP Graphics

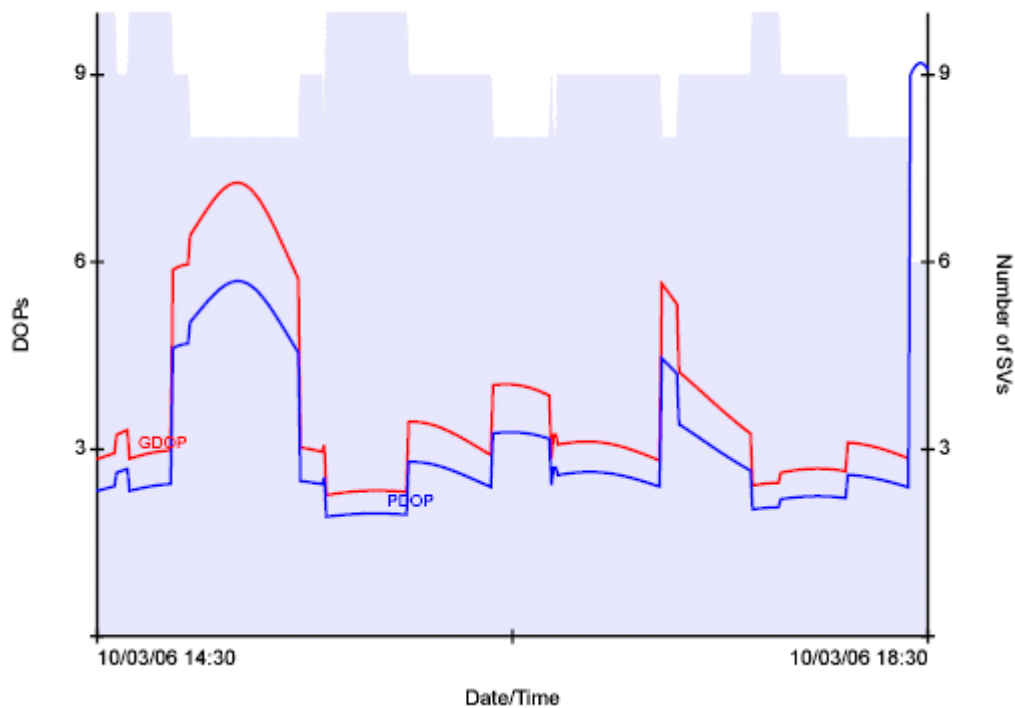

In a graphical representation the number of satellites and the DOP values are shown along the selected period of time. Each DOP is drawn in a different color. The changing number of satellites is shown in a light grey color in the background of the graphic.

Precise Ephemeris Management

Precise Ephemeris Management

Precise Ephemeris are imported directly into the database and can be used by different projects without being bound to one special project. This is why you are presented with a functionality under **Tools – Precise Ephemeris Management** that offers you to view those precise ephemeris you have already imported and delete those you do not need any longer. The functionality will always be active.

When invoked a new window with a simple report view (i.e. no tree-view) pops up, listing all precise ephemeris currently stored in the database. The report view consists of 5 columns showing:

Date:

Lists the date of the first data set in the file. Due to overlappings between two days, this may be the date of the day before. Typically, each precise ephemeris file is valid for only one day. Then **Date** lists the actual date of the precise ephemeris.

GNSS Type:

Specifies whether only GPS or GPS/GLONASS satellites are included in the file.

Date of Import:

Specifies the date when the particular file was imported.

Number of Satellites:

Lists the number of satellites covered by the selected file.

Satellites:

Lists the satellites' numbers themselves. G denotes GPS satellites and R denotes GLONASS satellites.

Agency:

Names the agency, which delivered the specific precise ephemeris file.

- When you want to delete a set of precise ephemeris from the database right-click on the selected lines and pick "Delete" from the context menu. A message box will be displayed, which gives you the chance to either delete the data sets one by one, to delete them all at once or to abort the function.
- When you want to import a new set of precise ephemeris you can do so from the same context menu or from the window background of the **Precise Ephemeris Management** itself. Clicking **Import** links you to the [Precise Ephemeris option of the main menu](#). After **Import** the report view will be updated.

Precise Ephemeris Import

This component allows you to import precise ephemeris information into the LGO database. A Precise ephemeris can be used to improve accuracy when processing long baselines that have been observed for long periods of time. Precise ephemeris files must be in the following format:

NGS/NOAA SP3-P (Position) format.

The SP3-P format is an internationally accepted standard ASCII format for precise ephemeris.

There are several services that provide precise ephemeris data, e.g.:

- IGN Global Data Center
- IGS International GPS Service for Geodynamics

Select from the Index to learn more about Precise Ephemeris:

[Internet Download](#)

[How to Import Precise Ephemeris](#)

Script Management

Script Management

LGO supports scripts written in either Visual Basic or in Microsoft Java programming language. These scripts can access the LGO database through an interface consisting of a wide series of **objects** each having its **attributes** and **methods**. Scripts can either be started from inside LGO or can alternatively be called from outside LGO and even from other programs. Scripts can especially be useful to automate routine tasks within LGO.

When invoked a new window with a simple report view (i.e. no tree-view) pops up, listing all scripts currently stored in the database. The report view consists of four columns showing:

Name:

The name of the script.

Description:

A non-mandatory description.

Location:

Path and file name of the script.

Language:

Visual Basic or **MS Jscripts** are supported.

From the context menu you can:

Create a new script:

Allows you to **add a new script** to the list. Enter a name and description, select the programming language and browse to the Visual Basic or MS Jscript file. Additionally, you can add an icon for your script by clicking onto the toolbar image button.

Run a script:

Starts the script from inside LGO.

Edit a script:

Opens the text editor and allows you to edit the source code of the script.

Delete a script:

Removes the script from the list.

Script properties:

Allows you to edit the **script properties**.

Tip:

- You may create a customized toolbar for Script Management. Go to **Tools - Customize...** and select the category **Scripts** from the **Commands tab**. In the toolbar only those icons linked to a script will be active. Clicking the toolbar button starts the script.

See also:

[Using the Howto Scripts](#)

[LGO Scripting Help Overview](#)

[The LGO Scripting Object Model](#)

Script Properties

This Property-Sheet enables you to enter, display and/or modify the Script properties.

- Right-click on a script in the Report-View and select **Properties...** from the context menu to display the script properties.

In the **Script properties** dialog you may view/ edit the following properties:

Name:

Enter or modify the script name.

Description:

Enter or modify the description for the selected script. Descriptions are optional.

Location:

Browse to the Visual Basic or MS Jscript file which shall be associated with the script.

Language type:

Choose between Visual Basic or MS JScripts to be associated with the script.

Toolbar image:

Scripts can have their own toolbar button for quick access. Select or change the toolbar image. On how to add the button to the toolbar see the following topic: [Customize a Toolbar](#).

Click the toolbar button to run the script.

Using the Howto Scripts

When you install LGO a series of example scripts is automatically installed on your harddisk. These sample scripts are all listed in the HowTo Index and include examples for the most commonly used functionality of the LGO Scripting. They help you to quickly understand how to use the objects, their methods and their properties.

To open the HowTo Index:

- Open the  **Script Management** from the **Tools** main menu. **Run** the script *Howto_Index*. If it is not stored in the Script Management, define it as a **new script** first by selecting it from its location. By default it is stored under *C:\Documents and Settings\All Users\Documents\LGO\Sample scripts\Howto\Howto_Index.vbs*.

When you run the script, a new window opens inside the LGO frame consisting of a tree-view at the left-hand side and the respective sample script being loaded on the right-hand side. The tree is divided into separate folders with each folder containing examples for a specific LGO Scripting object.

Each sample script starts with a short text explanation followed by a summary of the key commands that are used in the actual sample script. These key commands in a grey background can be taken over into your own scripts and can be modified there. This should help you to quickly get started with the LGO Scripting.

At the end of each script there is an actual script running which gives you the chance to execute the commands explained above.

For a full description on how the objects are defined please always refer to the [LGO Scripting Help](#).

[Example for a HowTo script:](#)

Howto: Index



- Howto
 - Auxiliaries
 - Coordinate System
 - Default Parameters
 - Import Export Settings
 - Project
 - [Howto copy project](#)
 - [Howto create project](#)
 - [Howto delete project](#)
 - [Howto export ascii](#)
 - [Howto export custom ascii](#)
 - [Howto export discad](#)
 - [Howto export rinex](#)
 - [Howto export user ascii](#)
 - [Howto import ascii](#)
 - [Howto import rawdata](#)
 - [Howto import rawdata file](#)
 - [Howto import user ascii](#)
 - [Howto iterating through project collection](#)
 - [Howto move project](#)
 - [Howto process project](#)
 - [Howto query dataproj parameter](#)
 - [Howto register project](#)
 - [Howto unregister project](#)
 - Points
 - Result
 - WScript

How to: Export ascii

This example script shows how to export a project to ASCII with invoking the LGO Export ASCII dialog.

Use the method **ExportAscii** for the object **Project**: "Project.ExportAscii" The ASCII File type and the settings are then selected in the dialog.

If you do not want the dialog to show up use the method ExportUserAscii or ExportCustomAscii.

The key commands of the script are shown below with the grey background.

```
'Create LGO application object
Set objLgoApplication = CreateObject( "LeicaGeoOffice.Application" )

'Get empty project collection
Set objProjects = objLgoApplication.Projects

'Find project by name
Set objProject = objProjects.FindByName( "myProject" )

'Export
objProject.ExportAscii
```

Feel free to export a project.

Project	PP Sample
	Export

LGOScripting Help

LGO Scripting Help Overview

The LGO Scripting Help provides you with a complete description of the [LGO Scripting Object Model](#).

LGO Scripting Objects

The **LGO Scripting Objects** are the interfaces to the LGO application and the LGO database. For each object the LGO Scripting Help provides a list of all **Operations** and **Properties**. Objects are marked with the key symbol in the Online Help. For example, the Projects object is displayed as follows:



Operations/ Methods

For each object all available **Operations** are listed. These operations, also called **methods**, are used to execute certain operations for the selected object. Methods are displayed in the LGO Scripting Help with the symbol as shown below. For example, the method 'Create' can be used for the Projects object to create a new project:



For each such method a Help topic explains all the parameters needed for the function. For the example of the command 'Projects. Create' the LGO Scripting Help explains the parameters needed to define the project name and the location where it shall be stored.

Properties

Each object may have a set of **Properties** that can be accessed. The LGO Scripting Help lists all available properties. Properties are displayed in the LGO Scripting Help with the symbol as shown below. For example, the property 'Name' can be used for the Project object to set the project name:



Enumerations

Various parameters of different LGO Scripting objects work with enumerated **Type Definitions**. The LGO Scripting Help contains the complete description of all **enumerations**. Refer to the book  **Type Definitions** inside the LGO Scripting Help. Enumerations are displayed with a symbol as shown below. This is an example of how you can define the parameter 'Point Class' within your script.



enmLgoPC

```
Enum enmLgoPC
  eLgoPCUnknown      = 0
  eLgoPCEstimated    = 1
  eLgoPCNavigated    = 2
  eLgoPCSPP           = 3
  eLgoPCMeasured     = 4
  eLgoPCAveraged     = 5
  eLgoPCReference    = 6
  eLgoPCAdjusted     = 7
  eLgoPCControl      = 8
  eLgoPCCurrent      = 100
  eLgoPCMain         = 200
  eLgoPCAll          = 300
End Enum
```

For a general overview on the various objects please refer to: [The LGO Scripting Object Model](#)

Note:

- For some interfaces there exist different objects depending on whether the object represents a collection or a single database object. For example the 'Projects' object represents the collection of all projects, whereas the 'Project' object represents a single project for which the project properties can be accessed.

The LGO Scripting Object Model

The LGO Scripting Objects are the interfaces to the LGO application and the LGO database. The following objects are supported:

Application

Provides access to the root object of the LGO Object Model. The following collection objects can be accessed for the Application object: Coordinate Systems and components, Codelists, Settings Manager, Projects and the Satellite Availability object.

Frame

The object for the global frame can be used with a method to open a HTML report embedded into the LGO frame. It also contains properties, which return the active or all open projects.

Codelist(s)

For the codelist collection object operations like 'Create', 'Delete' or 'Register' can be used.

For a single codelist object members for retrieving and setting the properties are available. When setting a property the 'Update' method will update the LGO database.

For every codelist object there are objects for codegroup(s), code(s), attribute description(s) and attribute values each having its operations and properties.

CoordSystem(s)

For the coordinate system collection object operations like 'Create', 'Delete', 'Add', 'Remove', 'Import', 'LoadAll' or 'Find' can be used.

For a single coordinate system object members for retrieving and setting the parameters are available. When setting a property the 'Update' method will update the LGO database.

In addition to the CoordSystem object separate LGO Scripting objects are available (collection objects and single item objects) for each of the coordinate system components:

Ellipsoid(s)

MapProjection(s)

StatePlaneZones

Transformation(s)

GeoidModel(s)

CSCSModel(s)

When working with these objects similar methods as for the Coordinate System(s) object are available.

SettingsManager

The LGO SettingsManager object includes members for retrieving all available settings objects.

Included objects are:

 **UserASCIIImportSettings** are created using a 'User ASCII Template' (*.uat) file. Operations like 'Create', 'Delete', 'Add', 'Remove', 'LoadAll' or 'Find' can be used.

 **UserASCIIExportSettings** are created using a 'User Export Settings' (*.ues) file. Operations like 'Create', 'Delete', 'Add', 'Remove', 'LoadAll' or 'Find' can be used.

 **CustomASCIIExportSettings** are created based upon a Format file (*.fmt). **Export settings** which are not included in the Format file can be accessed as properties of the **CustomAsciiExportSetting** object.

 **ShapeFileExportSettings** can be created with the Operation 'Create' for the collection object. For a single **ShapeFileExportSetting** object the properties can be modified.

 The **RawDataImportSetting** object contains properties for the settings of the **Assign Settings** page of the 'Raw Data Import' dialog.

 The **DataProcParameter** object allows you to set the default **GPS-processing parameters**.













For the **ASCII Import** and **ASCII Export** Settings collection objects and single item objects are available.

Project(s)

For the project collection object operations like 'Create', 'Register', 'Delete', 'Add', 'Remove', 'LoadAll' or 'Find' can be used.

For a single  **Project** object methods for exporting (ASCII, RINEX, GISCAD, LandXML), importing (Raw data, ASCII), processing, calculating loops and performing network adjustments are available. Methods for creating onboard jobs, calculating geoid separations, copying or unregistering are also supported. Members for retrieving and setting the project properties are available. When setting a property the 'Update' method will update the project database.

The **Project** object includes the

-  **Points**
-  **MeasuredPoints**
-  **ReferencePoints**
-  **Geometries**
-  **GPSTBaselines**
-  **GPSIntervals**
-  **GPSPoints**
-  **GPSSvArcs**
-  **GPSTracks**
-  **GPSWindows**
-  **Results**
-  **TPSSetups**
-  **TPSObservations**



ResultAdjustment



AdjustmentParameter

objects as additional important  **Properties**. These objects allow you to access different point triplets for a specified project as well as GPS tracks, intervals, satellite start/ stop times and baselines. You can query TPS observations and create or re-calculate TPS setups or Traverses. The Geometries object allows to access, create or modify lines and areas. The results of a GPS-processing run, a traverse computation and of a loops or an adjustment computation including all points of the result and the XML logfile document can be accessed. The GPS-processing, the Traverse-processing and the Adjustment parameters can be modified.

Report Template Management

Report Template Management

The Report Template Management component enables you to create new [Report Templates](#) or modify existing Report Templates. Additionally, it allows you to list the Report Template properties.

To start the Report Management

- From the **Tools** menu select  **Report Management** or click on  within the **Management** List Bar.

Select from the list below to learn more about Report Management:

[Report Templates](#)

[Create a New Report Template](#)



















[Delete a Report Template](#)

[Report Template Properties](#)

[Configure a Report](#)

Report Templates

Report Templates are the style sheets used for creating Reports. Report Templates are used for the following reports:

- **GPS-processing Results:**
 -  GPS Summary Report
 -  Baselines Report
 -  Kinematic Report
 -  SPP Report
- **Adjustment Results:**
 -  Pre-Analysis Report
 -  Network Report
 -  Loops Report
- **Level-processing Results:**
 -  Level Summary Report
- **Traverse-processing Results**
 -  Traverse Report
- **Setup Results**
 -  Setup Report
- **Sets of Angles Results**
 -  Sets of Angles Report
- **COGO Results**
 -  COGO Report
- **Surface Results**
 -  Surface Report
- **Quality Control:**
 -  Mean Coordinates & Differences Report
 -  Coordinate Comparison Report
 -  Satellite Availability Report
- **Import:**
 -  Fieldbook
- **Datum/ Map:**
 -  Transformation

For each of these components a default Report Template exists based upon which you may easily create your own templates to suit your very personal needs. With the help of Report templates you may individually define how your Reports shall look like and what shall be contained. You can define the **Font** used, the kind of **Alignment** and the **Coordinate Format**. You may even include your own personal **Logo**.

You may either:

- **Create a new template** based upon one of the default templates or
- **Modify** an existing template or
- **Delete** user-defined templates which are no longer used.



Create a new Report Template

1. In the Report-View or in the Tree-View right click on an existing Report Template and select **New...** from the context menu.
2. The **New Report Template** dialog opens and you may define a new template. The new template will be based upon the respective default template from which the context menu was invoked. You can change the **Type** if you wish to create a template for a different type of report.
3. Enter a unique **Name** for the user-defined template.
4. Optionally, enter a **Note** and select **Include Table of Contents**.
5. Define the **Contents** to be included in the user-defined template.
6. Define the **Coordinate Type** to be used in the report. This is only required for GPS projects where you may wish to switch the coordinates in your reports from *WGS84* to *Local* and vice versa.
7. Modify the **Format** so that paragraph styles and fonts suit your personal needs.
8. In the **Headers** property page you may browse for an individual Logo to be included.

Delete a Report Template

1. Right-click on the Template to be deleted in the Tree-View or Report-View and select **Delete**.
2. Press **Yes** to confirm or **No** to exit without deleting.

Note:

- The Default templates indicated by  are hardwired and cannot be deleted.
- User-defined templates, which are currently being used, are indicated by  and may not be deleted.

Report Template Properties

Report Template Properties

This Property-Sheet enables you to display and/or modify the Report Template Properties.

1. Right-click on a Report Template in the Tree-View or in the Report-View and select **Properties**.
2. Use the tabs to switch between the following pages:

General
Contents
Coordinate Types
Format
Header

For Adjustment Reports you can additionally define the **Confidence Levels** in the **Advanced** page.

3. Make your changes.

Note: Default Templates can also be edited. Press the **Defaults** button to reset the settings to the factory default.

4. Press **OK** to confirm or **Cancel** to abort the function.

Report Template Properties: General

This Property-Page enables you to display/edit the general Template properties.

Name:

Unique Report Template Name. For user-defined templates the name may be edited.

Type:

The Report Template Type is pre-defined by the default template upon which the user-defined template has been created. The Report Template Type defines for which kind of report the template can be used.

Note:

Optionally enter a Note.

Include Table of Contents:

Check this option if your Report shall contain a table of contents with hyperlinks to the subsections of the report.

Report Template Properties: Contents

In the **Contents** page of the **Report Template Properties** dialog it is defined which sections shall be included in a specific kind of Report. The available sections that can be defined vary for the different report template types.

- Click the **Defaults** button to restore the default contents of the selected report template.
- Click **Select All** or **Select None** to activate/ de-activate all contents.

Report Template Properties: Coordinate Types

In the **Coordinate Types** page of the **Report Template Properties** dialog it is defined in which system and type coordinates shall be displayed.

System:

Select *WGS84* or *Local*

Type:

Select between *Cartesian* or *Geodetic* or *Grid*.

Note: *Grid* is only available, if the **System** is set to *Local*. The coordinate system attached to the project must allow the conversion to the selected **System** and **Type** to be able to display the coordinates as requested.

Height mode:

If the **System** is set to *Local* you can define whether heights shall be displayed as *Orthometric* or *Ellipsoidal*.

WGS 84 Baselines:

For GPS Processing Results templates it is additionally possible to select whether the baseline vector components shall be displayed in *Cartesian* or in *Geodetic* coordinates.

Note:

- In the Fieldbook Report the following restrictions apply:
 - If the **System** is set to *WGS84* then the **Type** may be either *Geodetic* or *Cartesian*, the **Height Mode** is fixed to *Ellipsoidal*.
 - If the **System** is set to *Local* then only **Type** *Grid* is available, the **Height Mode** may be either *Ellipsoidal* or *Orthometric*.

The coordinate system attached to the job must allow the conversion to the selected **System**, **Type** and **Height Mode** to be able to display the coordinates as requested.

- For the Report Templates of the **Adjustment Results Reports** the coordinate type cannot be configured as a report template property, because the reports are always initially displayed in the coordinate system and type in which the adjustment was performed. It is however possible to switch the coordinate system and type using the Coordinate Format toolbar buttons.

Report Template Properties: Format

This Property-Page enables you to display/ edit the paragraph formatting and font style of the each single sub-section in the selected Report Template.

Section:

Each section in a report may be addressed individually. For each section paragraph alignment and font are defined separately. The section you are currently viewing/ editing is also indicated in the right hand graphical overview. In this graphical overview changes made to the alignment defaults are indicated schematically.

Alignment:

The paragraph alignment may be **Left**, **Center** or **Right** and may be defined separately for each section.

Font:

Press the Font button to view/ edit the currently defined font for the selected section.

To restore the defaults for a specific section, press the **Defaults** button.

Report Template Properties: Header

This Property-Page enables you to replace the default Logo with your own Logo.

- Press the  button and browse for one of the supported image files (**.BMP*, **.GIF*, **.JPG*, **.JPEG*).

The Logo will be put into the header of the report.

Report Template Properties: Advanced

In the **Advanced** page of the **Report Template Properties** dialog you may set the confidence levels at which the precision indicators (standard deviations and error ellipses) shall be expressed in the **Network Report**.

From the drop-down lists select the desired value for **1D-Coordinate elements** and **2D-Error ellipses**. The system default values are the standard 1-sigma values, i.e.:

- for 1D-Coordinate elements: 68.3%
- for 2D-Error ellipses: 39.4%

If you do not want to have all free observations included in the **Adjustment Network Report** de-select the checkbox **Include free observations**.

Note:

- Changing the confidence levels does not have any effect on the statistical tests.

Image Referencing

Image Referencing

The Image Referencing component enables you to manage background images for use within the **View/ Edit** component. **Referenced** images can be **attached** to a project and appear as background images in the **View/ Edit** component. Background images support you in identifying the location of newly measured points in a map.

In View/Edit the background image may only be displayed when the view is switched to the **local grid** representation of point coordinates. Thus, if you want to be able to profit from a referenced background image in View/Edit you either have to have local coordinates stored in your project or a Coordinate System attached.

To start the Image Referencing component:

- From the **Tools** menu select  **Image Referencing** or click on  within the **Management** List Bar.

The tree-view on the left-hand side contains all **registered** background images.

- Click on an image to open it in the right-hand side view.

In the lower part of the view you find a property view indicating the **image properties** and a report view listing all the points which have been identified in the image.

Before a background image can be referenced at least two common points have to be identified and matched. To learn more about how to match common points and how to reference a background image refer to: [Reference a background image](#).

Tip:

- In colorful images it might be advisable to blend the image to achieve a better contrast of the identical points to their background image. Select **Blend Image** from the context menu.
- The **Blend Image** functionality is also available from the context menu in **View/Edit** to achieve a better contrast of the representation of points, observations, Lines and Areas etc. to the **attached** background image.

Select from the list below to learn more about Image Referencing:

[Register a background image](#)

[Reference a background image](#)

[Image properties](#)

[Attach a background image to a project](#)

Register a background image

Before you can start referencing a background image you have to register the image.

1. Open the  **Image Referencing** component either from the **Tools** main menu or from the **Management** list bar.
2. Right-click into the background of either the tree-view or the corresponding report view and select **Register...** from the context menu.
3. In the **Register image** dialog browse to the location where you have stored your background images. By default **All supported graphic file** types found in the selected location will be listed for selection.
4. Select an image and press the **Register** button to add the image to the list of image which are available in the Image referencing component.



Note:

- To remove an image from the Image Referencing component without deleting it select **Unregister** from the context menu.
- If an **ESRI world file** is available in the same location as the graphic file, then the image will automatically be referenced according to the transformation elements stored in the ESRI world file. Images which are already geo-referenced (GEOTIF image files) will also be registered together with their image reference.
- The size of images that can be used depends on the memory of your PC. If the size of the image exceeds the practical limit of 64MB, it is recommended to resample the image.

Reference a background image

To reference an image the local grid coordinates of the image points have to be known so that points can be matched. Once the points have been matched the image can be oriented, i.e. referenced to the local grid.

To match common points:

1. To identify a point in the background image zoom in  to the area of the image where the common point is located. When you have identified the point double-click onto it to insert it into the image. A little cross  indicates the location of the point. Select from the context menu whether you want to **View the Point Id(s)** or not.
2. The point will be added to the report view with its image coordinates. When you have identified all common points proceed with **matching** them to their local grid coordinates. The image will be oriented to the local grid and new, measured points can be shown in the image.

Note: To delete points from the image either select a point in the image or select the point(s) to be deleted in the corresponding report view. Choose **Delete** from the context menu to delete the selected point(s).

3. In the report view enter the Easting and Northing of each common point manually via in-line editing.

Alternatively: Copy and paste (drag & drop) the coordinates of a common point out of a **project** into the Image Referencing view. The point will be added to the report view.

Note: Point coordinates can be copied out of those project views which offer access to the point properties, i.e. the View/Edit or the Adjustment view or the Points view.

4. Match the image coordinates of the common point with its local grid coordinates. Select both point representations in the report view, right-click into the selection and choose **Match point** from the context menu.

The image coordinates and the local grid coordinates of the point are matched.

Note: If the image point and the local grid representation of the common point have the same Point Id select **Auto match points** from the context menu to match all common points at once.

When at least two common points are matched the image can be referenced to the local grid.

- Right-click into the report view and select **Reference image** from the context menu.

The image will be oriented according to the local grid. Referenced images are indicated with the following icon:  in the upper right corner of the view. In the **property view** the status of the image changes from un-referenced to referenced.

Note: The more common points you have the better image distortions can be accounted for.

After an image has been referenced you can view the residuals of the transformation from image coordinates to grid coordinates in the report view:

- Right-click into the column heading and select **Columns...** from the context menu. In the **Columns** dialog switch on the columns **dE**, **dN** to view the residuals.

To store the transformation between image coordinates and local grid coordinates right-click into the report view and select **Save As ESRI worldfile**. A file which contains the transformation elements is written in the location where your image is stored. If you **register the image** again (e.g. on another PC) together with the ESRI worldfile, the image will automatically be referenced.

Image Properties

To view the properties of a registered image:

- Right-click on a background image in the tree view of the Image Referencing component or right-click on an image in the corresponding report view and select **Properties...** from the context menu.

In the Image Properties dialog general properties like the image's **name**, its **filename**, the **date** when it has last been modified and its **size** are indicated to you. You can also see whether the background image has already been **referenced** or not.

The name by which an image is identified can be modified.

Project

Projects

A Project is a set of data items that belong together. These data items are stored in a Project database.

A GPS Project can hold point coordinates in WGS84 **and** Local Coordinate Systems. If in a GPS project a **Coordinate System** defining the parameters for the Local system is attached it enables you to switch the Coordinates from WGS84 to Local.

If with the current project WGS84 coordinates are stored or a coordinate system is attached to be able to convert local grid coordinates to WGS84 then **Google Earth** may be launched to visualize your survey data in the satellite images offered by Google Earth.

If a **referenced image** is attached to a project **and** local coordinates are available the map may be viewed as a background image in the **View/Edit** tabbed view. Common points as well as newly measured points can be identified in the image as to their local location.

If one or more **CAD files** are **attached** to the project the graphical entities contained in the CAD file(s) may be **viewed** as background maps. A selection of CAD entities may be picked from the CAD file and **imported** into the LGO project.

The **Project Management** component allows you to handle Projects. Upon opening a Project a **Tabbed View** will enable you to instantly switch between the following views:

Click the tabs to read more about the corresponding view:

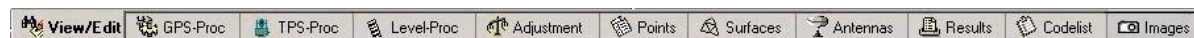

Google Earth

If at least one project is open and if with the current project either WGS 84 coordinates are stored or a coordinate system is attached to be able to convert local grid coordinates to WGS84 then the Google Earth functionality within LGO offers you the chance to visualize your survey data in the satellite images offered by Google Earth. Google Earth can only handle WGS 84 coordinates. Thus an error message is issued if local grid coordinates cannot be converted.

- From the **View** menu or from the **Standard** toolbar choose  **Google Earth**.

Point coordinate information as well as GPS and/ or TPS observations will be transferred from the currently active project to Google Earth. If the project contains Lines/ Areas and/ or Surfaces these can be shown in Google Earth as well. By default, only the visualization of points is active in Google Earth. The other components (Observations, Lines, Areas, Surfaces) may be switched on as required in the **Places** pane of Google Earth.

Temporary Places:

A temporary place will be created with the same name that the active project has. Depending on which elements the project offers (Points and/ or Observations and/ or Lines, Areas and/ or Surfaces) sub-nodes will be inserted by Google Earth to differentiate between the elements and make them manageable separately:

Points:

Depending on the class the points have in LGO when Google Earth is invoked (i.e. according to the **current point class**) sub-nodes will be created for:

Control & Reference points comprising the LGO classes *Control, Adjusted, Reference*.

Measured points comprising the LGO classes *Averaged, Measured*.

Other points comprising the LGO classes *Single Point Solution, Navigated, Estimated*.

The point classes are differentiated in Google Earth by different colors.

Lines/ Areas:

Lines and areas come across in Google Earth with the **color and style properties** they have in LGO.

GPS/ TPS Observations:

Observations come across in Google Earth with their default color and style.

Surfaces:

Surfaces and **Contour lines** come across in Google Earth with the color and style properties they have in LGO.

Operations in Google Earth:

- Click onto the top-node link which is shown in the **Temporary Places** tree view for the current project to invoke detailed information on the transformation, projection and ellipsoid used with the current project.
- Click with the left mouse button onto the link for a single item (a point, an observation, a line or area, a surface) in its sub-node to invoke the core **Properties** of Points, Observations, Lines/ Areas and Surfaces.

Alternatively: Click onto a point, an observation, a line or area or a surface in the map view to invoke the element properties.

If thematical codes are available for an item or **images** are attached these will be indicated as well. For points a camera symbol replaces the point symbol if one or more images are attached to a specific point.

- Right-click onto an item in the map view or on an item or a group of items in the tree view and select **Properties** from the Google Earth context menu to change the style and color for the selected item(s).

- Right-click onto the top-node of the temporary place and select **Save to My Places** from the Google Earth context menu to save the data imported from the current LGO project to a permanent place in Google Earth.
- Right-click onto a place, a group of elements or onto single elements and select **Save Place as ...** from the Google Earth context menu to save the selected place or elements in a *.kmz file which may be re-distributed to other users. Double-click onto the *.kmz file to create a temporary place of the saved data in Google Earth.

Note: If images are attached to a point, line or area these will not be saved to the *.kmz / *.kml file when created in Google Earth. If you want to re-distribute attached images as well, deliver them to another user together with the *.kmz file stored in your LGO project folder. Both, the *.kmz file and the image files have to be copied to the same folder to make Google Earth recognize the images.

- Right-click and select **Email ...** from the Google Earth context menu to attach the data as presented in Google Earth as a *.kmz file to an e-mail. The receiver of this e-mail can open the *.kmz file from within his or her mail program in Google Earth by simply opening the attachment.

Note:

- To be able to make use of this functionality make sure Google Earth is installed on your computer.
- If you have more than one project open at a time then the Point coordinate information from the currently active project will be taken for visualizing the location of your data in Google Earth.

View / Edit

View/Edit

View/Edit enables you to display a graphical representation of all points and baselines contained in the Project database. If a **Coordinate System** is attached to the Project or if *WGS84* and *Local* coordinates are stored in your project, you may switch the view to display either *WGS84* coordinates or *Local* coordinates. The coordinate type is fixed to *WGS84 Geodetic* or *Local Grid* in the graphical views.

If a **referenced image** is **attached** to the project it may be displayed as a background image in View/Edit. The location of newly measured points in a map or aerial photograph of the region is visualized and becomes easily identifiable. The background image may be switched on and off via the **graphical settings**.

Line and Area objects measured in the field may be graphically represented in the View/Edit component. The representation of Line and Area objects may be switched on and off via the **graphical settings**.

Images that have either been imported manually or with a SmartWorx job and which are available in the **Images** view can be linked to a specific point or line or area.

If one or more **CAD files** are **attached** to the project the graphical entities contained in the CAD file(s) may be **viewed** as background maps. A selection of CAD entities may be picked from the CAD file and **imported** into the LGO project as Points or Line/ Area objects.

Points and observations may be selected graphically and properties may be viewed and edited. Additionally, you may display the direction and distance between two points. Make use of the **Point Editor** to easily enter and/ or edit local grid coordinates for sets of existing or new points.

A selection of points may be sent to the Hard disk or to the Local Memory Device directly via the **Send To** functionality.

By default, **Panning** is switched on so that you can comfortably navigate within the view. The **Scroll to selected point** tool makes it easy to focus on a special point. To enlarge or reduce the view make use of the **Zoom** functionality.

- View/Edit may be accessed via the  **View/Edit** Tab from within a project window.

Select from the list below to learn more about View/Edit:

[New Point/ New Line/ Area](#)

[Activate / De-activate](#)

[Delete](#)

[CAD Entities](#)

[Assign points to a surface](#)

[Zoom In](#)

[Zoom Out](#)

[Zoom 100%](#)

[Panning](#)

Show Direction & Distance
Show GPS Loop Misclosure

Send To

Compute Average Combined Factor
Shift/ Rotate/ Scale
Exchange Coordinate System (Smart Station)
Update Reference Triplet
Shift Reference Triplet
Rename Tool
Point Editor
Link image to point/ line/ area

Observations View
Lines/ Areas View

Graphical Settings

Edit Intervals
Re-assign Intervals
Re-assign Reference Triplets
Re-assign Measured Triplets

Point Properties
Observation Properties
Line/ Area Properties

Scroll to a selected point

Image Referencing

Panning

Panning is a feature of most of the graphical views inside LGO. It allows you to comfortably move a view without having to scroll left and right and up and down.

- Click with the left mouse button into a graphical view (the cursor changes into a 'hand') and keep it pressed to move the displayed area into any direction.

The Pan mode is by default switched on.

- To switch the Panning functionality off click the corresponding toolbar button  or de-select **Panning** from the view's background menu.
- To temporarily switch off the Panning mode keep the **Shift**-key pressed.

To select a series of points and/ or observations while Panning is **switched on**:

- Keep the **Shift**-key pressed to drag a rectangle around the items you want to select.

Keep the **Shift**-key or the **Ctrl**-key pressed to select individual items or draw separate rectangles around several groups of items.

To 'Drag and Drop' data items while Panning is **switched on**:



- Keep the **Shift**-key pressed while dragging and dropping (copying and pasting) data items according to the rules given in the corresponding topic.

Note:

- Panning is also available in the graphical views inside **Wizards**. In Wizards the Panning functionality is by default switched off.



Rename Tool

The Rename Tool offers you the chance to rename a selection of points or lines/ areas.

- In  **View/ Edit** or in the  **Points View** select the points to be renamed and open the  **Rename Tool ...** from the **View/ Edit** or the **Points** main menu

Alternatively: Open the **Rename Tool ...** from the **View/ Edit** background menu or the **Points** context menu.

- In the **Lines/ Areas View** select the lines/ areas to be renamed and open the **Rename Tool ...** from the context menu.

The selected points or lines/ areas are listed in the Rename Tool with their **Current ID** and their **New ID**. If you see that by chance a point or line/ area is included that shall not be renamed it may be deleted from the selection by pressing the  **Delete item** button. You may also change the order of the points in the list by selecting a point and pressing the  **Move up/ down** buttons.

General:

Insert new ID:

Insert a new Id for the selected points. The new Id can be composed of new alphanumeric characters plus the **current Id** or **parts of the current Id**. Additionally, a **numeric counter** may be inserted. Spaces, dashes, dots and underscores may serve as separators.

Add/ insert current ID:

Press the button to insert the Id which the point(s) or line(s)/ area(s) currently have into the **Insert new ID** field. Before or after you may enter any combination of alphanumeric characters or add a counter to modify the current ID as desired.

Add/insert part of current ID:

Press the button to select and insert a part of the Id which the point(s) or line(s)/ area(s) currently have into the **Insert new ID** field. Before or after you may enter any combination of alphanumeric characters or add a counter to modify the partly used current ID as desired.

Add/ insert numeric counter:

Press the button to insert a numeric counter for renumbering the IDs. The following selection fields become active to define the counter:

Start counter at:

Define the number to start counting with.

Increment counter by:

Define how the counter shall be incremented.

Counter digits:

Define the digits that shall be reserved for inserting the counter.

A preview of the newly defined ID is given in the list below.

When you have finished redefining the IDs for the selected points, lines/ areas press **OK** to confirm the renaming and close the tool.

Press **Apply** to confirm the renaming and take over the **New IDs** as **Current IDs** as the basis for the next change without closing the tool. New IDs that are confirmed with **Apply** are remembered and offered in the **Insert new ID** drop down list for future selection.

Search and Replace:

Search for:

You may search for parts of the **current** Point or Line/ Area Ids that shall be renamed and replace these parts with a new combination of alphanumeric characters. You may also search for Spaces, dashes, dots and underscores to be replaced.

Note: Ids that have previously been confirmed by **Apply** are identified as the current Ids.

Replace with:

Define a replacement for the **Search** string. Spaces, dashes, dots and underscores may also serve or be included as part of the **Replace** string. If you want to remove a fixed part of the current IDs leave the replace string **empty**.

Again a preview of the **new** Point Ids is given in the list below.

When you have finished searching for and replacing IDs for the selected points, lines/ areas press **OK** to confirm the renaming and close the tool.

Press **Apply** to take over the **New IDs** as **Current IDs**. Search and Replace strings that have been confirmed with **Apply** are offered in the drop-down lists to be selected for future Search and Replace runs.



CAD Entities

Viewing CAD files and managing CAD file layers

In  **View/ Edit** you may view CAD files which are **attached to the project** as background maps.

To be able to view attached CAD files as background maps you have to switch them on in the **Graphical Settings: View** page. Only if CAD files are switched **on** in the **Graphical settings** will functionality for managing layers be available.



To switch on and off single layers of attached CAD file(s):

- Click on the  **Select CAD file layers** button in the **Standard** or in the **View** toolbar and in the drop-down list of layers switch on  or off  single layers by clicking onto the light bulb with the left mouse button.

To switch on or off more than one layer at a time highlight the layers to be hidden or made visible and click onto the light bulb for one of the selected layers to switch all of them on or off.

Follow the rules for the Selection of Data Items if you want to select (highlight) more than one layer at a time.



To make single layers of attached CAD file(s) selectable:

- Click on the  **Select CAD file layers** button in the **Standard** or in the **View** toolbar and in the drop-down list of layers make single layers selectable  or not selectable  by clicking onto the mouse pointer symbol with the left mouse button.

To make more than one layer at a time selectable or not selectable highlight the layers and click onto the mouse pointer symbol for one of the selected layers to make all of them selectable or not selectable.

Follow the rules for the Selection of Data Items if you want to select (highlight) more than one layer at a time.

Note: If more than one CAD file is attached to your project and the files contain layers with identical names then changing the status of a layer (switching it on or off or making it selectable or not selectable) affects all background maps which contain a layer of that name.

The **CAD file entities** on layers which are switched on  and which are selectable  can be picked and imported into the LGO project to which the CAD files are attached.

Learn more about importing CAD files entities and editing CAD entity properties in:

[Import CAD file entities](#)

[CAD Entity Properties](#)

Import CAD file entities

If a project has one or more CAD files **attached** then it is possible to import CAD entities to LGO. You can select a single CAD entity or a selection of CAD entities for import, or even multiple layers.

To define global settings for the import of CAD entities into an LGO project:

- Go to **Tools - Options: CAD Import** in the main menu and make your settings for the **default point class** the imported points shall take, for the **Point, Line and Area ID prefixes**, the interpretation of **height values** and the **conversion of white elements**.

To select CAD entities:

1. To be able to pick entities from a layer for import make sure that the layer is **visible** and its status set to **selectable**.
2. Click with the left mouse button onto the entity you want to import into the LGO project. If necessary enlarge the view via the **Zoom** functionality.

If you want to select more than one entity for import keep the Ctrl- or the Shift-key pressed while selecting single entities with a left mouse click.

You may also pick a whole range of entities by **drawing a rectangle** around the entities you want to select.

The colour of the selected entities changes to red and the entities are displayed in bold style.

3. Right-click into the view's background and go to **CAD Entities** in the background menu. From the drop-down context menu select how you want to proceed.

If you have only selected a single entity you may also right-click onto the selected entity and choose from the context menu how you want to proceed.

The following options are available for the import of CAD file entities:

Import

The selected entity will be imported into the current project and the points belonging to the entity will be created in LGO. If the entity is of type line or area then a Line/ Area object will be created along with its points. If the entity is only a point then just the point will be created.

Import points only

If you selected an entity of type line or area then with this option only the points belonging to the object will be imported and created in LGO.

Import all from layer

All entities (points, lines, areas) belonging to the same layer as the selected entity will be imported into the current project. For lines and areas Line and Area objects will be created in LGO plus the points belonging to the objects.

Import all points from layer

All points belonging to the same layer as the selected entity will be imported into the current project. No Line or Area objects will be created in LGO.



Furthermore, you have the chance to:

Hide the layer

If you select this option then the layer to which the selected entity belongs will be switched off and hidden from view.

Set the layer not selectable

If you select this option then the entities on this layer will still be visible but no longer selectable.

To switch the layer on again or to make the entities from this layer selectable again you have to press the  **Select CAD file layers** button in the **Standard** or in the **View** toolbar and reset the layer status to be  visible and  selectable.

For single selected entities you may also view and edit the **CAD Entity Properties** by selecting **Properties...** from the context menu.

CAD Entity Properties

If a project has one or more CAD files **attached** then you can pick single entities and invoke information on the entity properties via a context menu.

- Right-click onto an entity and select **Properties...** from the context menu. The current entity properties as defined in the DXF are shown.

Note: Only on **selectable** layers you will be able to pick entities and invoke the **Properties** dialog.

- Press the **Import** button to import a selected CAD entity from the attached CAD files into the LGO project.

Note: If the entity is of type line or area then a Line/ Area object will be created along with the points belonging to the entity. If the entity is only a point then just the point will be created.

After import into the LGO project a Line/ Area object will appear as defined in the **CAD Entity Properties** dialog.

If the settings in the **CAD Entity Properties** dialog are changed, these changes will only affect which properties a point, line or area will have in LGO after import. The DXF file will **not** be updated or changed by changing the CAD Entity Properties.

In the **CAD Properties** dialog you may view and edit the following items

Point/ Line/ Area Id:

In this combo box the ID of the selected CAD entity is listed. The CAD entity will be classified as either Point or Line or Area depending on its Type. You may change the Id for import into the LGO project.

Type:

The entity's type of geometry is listed. It can be either *Point* or a line of either type *Line* or *Polyline* or *Arc/Elliptic arc* or *Spline* or an area of either type *Polygon* or *Circle/Ellipse*.

Layer:

The layer to which the selected entity belongs is listed.

Code:

Lists the point/ line/ area codes as defined in the project codelist. If you select a line/ area code from this combo box, the **Border Style**, **Color** and **Width** are set according to the line/ area code and the corresponding combo boxes become read-only. The line/ area code controls the style, color and width properties as defined by the codelist.

If you select line/ area code **None** then the style, color and width properties become editable.

The following properties are only applicable to entities classified as Line or Area:

Line/ Border Style:

Lists all supported line/ border styles (solid, dash, dot and dashdot combinations).

Line/ Border Color:

Lists all supported line/ border colors (all colors and color shadings as well as all grey shadings).

Line/ Border Width:

Lists all supported line/ border widths (from 1/4 pt to 6 pt).

Shading Style (Area properties only):

Lists all supported shading styles. The shading style defines the pattern with which the area is filled. If you want the area to be fully filled (without a pattern) select the 'blank' shading style, i.e. the first option in the list.

Shading Color (Area properties only):

Lists all supported shading colors (all colors and color shadings as well as all grey shadings).

Points and Observations

Point (Coordinate) Classes and Subclasses

The coordinate class describes the type and/or source of a coordinate triplet. For each point there may exist more than one coordinate triplet in the Office database.

The coordinate classes represent the hierarchical order of the coordinate triplets. The **Points View** displays the active coordinate triplet for each point. By default the triplet with the highest class is active.

E.g. if you import GPS raw data, the points are imported with *Navigated* coordinate triplets attached. After processing the baseline a coordinate triplet *Measured* is added to the point. After processing another baseline for the same point another coordinate triplet *Measured* is added and an average is calculated. The average calculation adds another coordinate triplet of class *Average* to the point. Later the point is used in an Adjustment which adds the adjusted coordinates as a coordinate triplet of class *Adjusted* to the point and so on.

The point subclass on the other hand gives an indication to the user as to the source from which the coordinate came.

The following list represents the Coordinate Classes in the ascending hierarchical order:

<u>Symb</u>	<u>Class Id</u>	<u>Description</u>
+	Estimated	<p>This coordinate class is required to support the Adjustment component when terrestrial observations are involved. Before an adjustment can begin, provisional (<i>estimated</i>) coordinates are required for each point.</p> <p>The subclass of <i>Estimated</i> is always None.</p>
□	Navigated	<p>Navigated coordinates derived using the uncorrected Code solution of a single epoch. E.g. points that are imported via GPS data import and that have not yet been post-processed are awarded point class <i>Navigated</i>.</p> <p>The subclass of <i>Navigated</i> is always Code only</p>
⊗	Single point position	<p>Coordinates derived using the Single Point Positioning (SPP) processing of the GPS-Processing kernel or a GPS receiver.</p> <p>The subclass of <i>Single point Position</i> is always Code only</p>
⊙	Measured	<p>Coordinates that have been differentially corrected using GPS post-processing or Real-time are awarded this point class. Target points of TPS observations will also have coordinate class <i>Measured</i>.</p> <p>Note that only the class <i>Measured</i> can hold more than one coordinate triplet. If more than one coordinate triplet for one point exists, the different coordinate triplets are automatically averaged and the point is awarded the point class <i>Average</i>.</p> <p>Depending on the source of the coordinate triplet, the point may have the following subclasses:</p> <ul style="list-style-type: none"> - Code Only Code only solution from post-processing - Phase Fixed Phase solution from post-processing - Phase Phase solution from RTK - None Target point of a TPS observation - Hidden Calculated solution for a Hidden Point - (Aux) With this suffix the auxiliari points for Hidden Points will be marked.
⊗	Averaged	<p>Averaged coordinates of points for which two or more measurements exist. Averaging algorithms exist in the office software as well as on the sensor.</p> <p>Note: Measured triplets stored in different coordinate systems (WGS84 or Local) or coordinate types (Cartesian, Geodetic or Grid) can also be averaged if the attached coordinate system allows the conversion.</p>

The subclass of *Averaged* is always *None*.

▼	Reference	<p>For points that have been used as a Reference for GPS Post-Processing or GPS Real-Time, a coordinate triplet of class <i>Reference</i> will be added. Such GPS Reference triplets will always be stored in the WGS84 coordinate system.</p> <p>Point class <i>Reference</i> is also used for points which are associated with a setup which has connected TPS or Level observations in Adjustment.</p> <p>Note: Only one Reference triplet can exist for anyone point.</p>
🔄	Adjusted	<p>Coordinates that have been adjusted using the Adjustment program.</p> <p>Note: Since GPS Hidden Points do not take part in the Adjustment they will not be awarded point class Adjusted afterwards even though subsequently their coordinates might have changed. Thus, when you want to export e.g. all adjusted points, be aware that you have to export the Hidden Points separately.</p>
▲	Control	<p>Coordinates of class <i>Control</i> primarily serve as fixed coordinates for the network adjustment. It is the highest point class and should be used if you enter Coordinates manually. Depending on whether they are fixed in position, fixed in height or both, they may have different subclasses and will be represented by different symbols:</p> <p>▲ Fixed in Position and Height ▲ Fixed in Position ▲ Fixed in Height</p>

Note:

- Coordinates that are manually entered may be awarded either the point class *Estimated* or *Control* only.

Tip:

- On how to copy and paste triplets easily refer to: [Copy and Paste triplets in the Point Properties: General page](#).

Point Classes and Subclasses (Level)

The **point class** describes the type and/or source of a point height. For each point there may exist more than one height in the LGO database.

The point classes represent the hierarchical order of a point's heights. The **Points View** displays the currently active point class for each point. By default the height with the highest class is active.

The point class in the **booking sheet** is independent of the currently active point class in the Points View. In the booking sheet the only two point classes to be displayed are *Measured* and *Control*. Other classes like for example *Averaged* may only be displayed in the Points View.

See also: [Changing Point Classes in the Booking Sheet](#)

The **point subclass** supplies additional information relevant to the individual class. The subclass indicates to the user the source the height came from.

The following list shows the Point Classes in ascending hierarchical order:

<u>Class Id</u>	<u>Description</u>
Measured	<p>Class of heights that have either been calculated by the Level instrument while the Level line was measured or that have been processed in LGO.</p> <p>Measured point heights can be modified in the booking sheet. Accordingly, all measured heights in the level line will be shifted by the same amount.</p> <p>Depending on the source of the measured height a point of this class may have the following subclasses:</p> <ul style="list-style-type: none"> - None: if the height is the measured raw height as it has been imported from the level instrument via Raw Data Import. - (Level) Processed: if the point has a height resulting from a processing run in LGO. <p>Note: <i>Measured</i> is the only point class which can comprise more than one height coordinate. If more than one measured height exists for a point the average will automatically be calculated. Points with an averaged height coordinate are awarded the additional class <i>Averaged</i>.</p>
Averaged	<p>Class of points for which more than one height of class <i>Measured</i> exists. The subclass of <i>Averaged</i> is always <i>None</i>.</p>
Control	<p>To process a level line in LGO at least one point must be of class <i>Control</i>. Control heights are retained in a processing run. They serve as the basis relative to which all other points are computed.</p> <p>By default the first point in a level line will be set to class <i>Control</i> when importing level raw data. It is assumed that the first point in a line has the known start height.</p> <p>To change the default and fix point heights manually in the booking sheet select Create Control from the context-menu.</p> <p>In level projects the subclass of <i>Control</i> points is <i>Fixed in Height</i>.</p> <p>Note: When you create a control you may fix the point's height to a different value than the measured height value. Changing the point height in creating a control does not simultaneously affect the heights of all other points. Neither the heights of all measured points in the line nor the heights of other controls will be shifted by the same amount.</p>

New Point (graphical views)

Allows you to graphically or manually add a new point to the database.

1. **Right-click** in the place within the background of the graphical window where you want to create a new point and select **New Point**.
2. Enter **Point Id**.
3. Optionally, adapt the parameters and/or the coordinates of the point.
4. Press **OK** to confirm or **Cancel** to abort the function.

Tip:

- Click **Apply** instead of OK if you want to manually enter a **series of points**.
- You can also create a new 2D point by **double-clicking** in the graphical window. The coordinate class *Estimated* and a Point Id (New Point 1, New Point 2...) will be assigned automatically.

Note:

- If the location of the new point is selected graphically using the mouse, the accuracy of the coordinates depends on the resolution of your computer's screen as well as on the size of the area being displayed (zoom status).

Delete Points/ Triplets (graphical views)

Enables you to delete all or individual coordinate class triplets of a Point.

To delete a point:

1. Highlight a point and select **Delete** and then **Point** from the context-menu or from the **View/ Edit** or **Adjustment** main menu.
2. Press **Yes** to confirm or **No** to exit without deleting.

Note:

- If you delete a Point, all coordinate triplets and all associated data including raw data will be deleted permanently from the database.

To delete point triplets:

To delete a particular coordinate class (coordinate triplet) of one or a series of points, highlight the point(s) to be deleted, and select **Delete** and then **Triplets** from the context menu or the **View/ Edit** or **Adjustment** main menu and select an individual class from the list.

Note:

- If you delete the only coordinate triplet that exists for a point, the entire point will be deleted from the database.
- If you delete the *Averaged* point triplet, **all** *Measured* triplets will be deleted as well.

Tip:

- If you select a series of Points all of them can be deleted at once. To select all points you may also press Ctrl-A on the keyboard.

Point Properties

Point Properties (graphical views)

This Property-Sheet enables you to display and/or modify the Point Properties.

- In the Graphical-View right-click on a Point and select **Properties**.
Alternatively: Double-click on a Point.
- Use the tabs to switch between the following pages:
 - General
 - Stochastics
 - Setup
 - Thematical Data
 - Reliability (available only if the reliability has been previously calculated using the Adjustment component)
 - Mean (available only if more than one coordinate triplet of class *Measured* for a particular point exists)
 - Images (available only if at least one image is linked to the selected point)

Hidden Point functionality is only available for **GPS** measurements. **Hidden Point Properties** can only be displayed in the **View/ Edit** component or in the **Points View**:

 - Hidden Point (Position) (available only if the selected point is a Hidden Point)
 - Hidden Point (Height) (available only if the Hidden Point has height properties attached)
- Make your changes
Note: Only the fields with a white background may be edited at that particular instant.
- Press **OK** to confirm or **Cancel** to abort the function.

Alternatively:

- Select a Point from the List-box  and press Edit selected Point  from the Toolbar.

Point Properties: Setup

Enables you to display/edit the instrument Setup of a point. A Setup describes the type of Instrument that was used on a particular point. Thus a Setup in the case of GPS will be where a GPS reference station was situated, in the case of terrestrial measurements it will be where the instrument was situated.

List box

Displays the **Date/Time** the setup was created, the **Type** of setup and the **Point Id**. If more than one Setup for a particular point exists, select from the list.

Setup type:

The setup type is displayed but can not be changed via Point Properties.

Instrument height:

If the setup type is TPS you may change the instrument height.

For **SmartWorx TPS setups** the following changes are applied when changing the Instrument height: If the instrument height was used in the field to calculate the height of the target points (**Set Orientation**, **Known Backsight**), then a change in the instrument height will automatically modify the heights of all connected target points by the same amount.

For the **Resection** methods and the methods **Multiple Backsights** and **Height Transfer** a change in the instrument height only modifies the height of the setup, but not the heights of the connected target points, unless the height of the setup was excluded from the setup calculation.

If the setup was not imported from SmartWorx raw data (but using GSI or TDS raw data import or if it was manually entered), then a change of the Instrument height will always modify all connected target points.

Centring error:

The centring error defines the predicted error that could have been made when centring the instrument (reference) over the point.

Height error:

The Height error defines the predicted error when measuring the instrument (reference) height.

Active:

You may deactivate the setup by clearing the Active check box. This will remove the setup and any associated observations from the adjustment computation.

Note:

- When a GPS setup is selected, the instrument height may not be edited. This is due to the fact that the Adjustment does not obtain this information from LGO and a change in instrument height would require a re-computation of the GPS baselines.
- With a TPS Setup, all categories are available for editing.
- With an Azimuth Setup only the centring error may be edited. This is because there is no height information and only horizontal angles are of concern.

Edit Interval (View/ Edit)

Enables you to display and edit the Interval Properties of the selected Point such as Antenna Properties and Annotations.

1. Right-click on a point and select **Edit Interval**.
2. Use the tabs to switch between the following pages:
[Antenna](#)
[Annotation](#)
3. Make your changes
Note: Only the fields with white background may be edited at the particular instant.
4. Press **OK** to confirm or **Cancel** to abort the function.

Alternatively:

- Select a Point from the List-box  and press Edit interval  from the Toolbar.

Re-assign Intervals

Enables you to re-assign a single static observation interval to another Point Id. E.g. if the same Point Id was occupied twice using static GPS techniques.

1. Right-click on a point and select **Re-assign...**(or **Re-assign interval**)
2. If the selected point consists of more than one interval, select the interval(s) to be re-assigned from the list or press **Select All**.
3. In **From Point Id xx to** select a Point Id to which the interval(s) should be re-assigned from the list of available points or enter a new Point Id.
4. Press **OK** to confirm or **Cancel** to abort the function.

Note:

- Only static intervals can be re-assigned. Instantaneous ("time tagged") points do not have an interval connected and cannot be re-assigned (re-named) to an existing Point Id.
- You can also re-assign an interval to another Point Id by modifying the Point Id to that of an existing Point Id in the GPS-Processing interval view.

Link or unlink Images

All images which are available in the **Images** view may be manually **linked** to **points**, **lines** or **areas** within the same LGO project.

To link one or more images from within the Images view:

1. Click onto the  **Images** top node in the tree view to see the complete collection of all available images in the corresponding thumbnail view on the right.

Alternatively, click onto the  **Not linked** node to see only those images in the thumbnail view which are not yet linked.

2. Select the images to be linked in the thumbnail view and choose **Link** either from the context menu or from the **Images** main menu.
If you know that an image is linked already to a specific point, line or area you may also open the thumbnail view for that point, line or area and select the image to be linked again from there.
3. In the **Link Image** dialog select the **Point** or the **Line** or the **Area** to which the selected image(s) shall be linked.
4. Leave the dialog with **OK**.

To link one or more images from within View/ Edit:

1. Right-click onto a point or a line or an area and select **Link image to point/ line/ area ...** from the context menu.
2. In the **Link Image** dialog all images that are available with the current project will be shown to you in a thumbnail view together with the image name.

If you want to be offered for selection just the still unlinked images check the option **Show unlinked images only**.



3. Select the images to be linked with the selected point / line/ area from the thumbnail view.
4. Leave the dialog with **OK**.

The selected image(s) will be linked to the point or line or area as specified in the **Link Image** dialog.

In the  **Images** view a node for  **Points** or  **Lines/ Areas** will be added to the tree view if it is not available yet. If a specific point or line or area does not have images linked before it will be added under its node and in the corresponding thumbnail view the newly linked images will be shown. If a specific point or line or area does already have linked images the newly linked images will be added to the thumbnail view.

In  **View/ Edit** the point symbol changes to indicate that images are linked. If all images that have been linked to a point are unlinked again the point symbol changes back to indicate the current point class.





To unlink one or more images from within the Images view:

1. Open the node for  **Points** or  **Lines/ Areas** and select a specific point or line or area from which one or more images shall be unlinked.
2. In the thumbnail view for the selected object select the image(s) to be unlinked and choose **Unlink** from the context menu.
3. Confirm the warning message that is issued with **Yes** to unlink the selected images.

To unlink one or more images from within View/ Edit:

1. Right-click onto a point or a line or an area to which images are linked and select **Properties...** from the context menu.
2. In the **Properties** dialog go to the **Images** tab and select the images to be unlinked from the selected object in the thumbnail view.
3. Right-click into the selection and choose **Unlink** from the context menu.
4. Confirm the warning message that is issued with **Yes** to unlink the selected images.

Note:

- In the  **Images** view the **Unlink** functionality is only available for specific objects. You cannot unlink images from within the thumbnail view for the  **Images** top node.
- If an image is linked to more than one object it is only moved to the  **Not linked** node in the  **Images** view when it is unlinked from **all** objects.

Observation Properties

This Property-Sheet enables you to display and/or modify the observation properties.

1. Right-click on an observation in the graphical view and select **Properties**.

One or more of the following Property-Pages will be displayed:

GPS - GPS Baseline information

RTK Info - Info on the used reference station network

TPS - TPS angle and distance measurements

Azimuth - Horizontal angle reading from theodolite or compass

Level - Height difference observation.

2. Make your changes

Note: Only the fields having a white background may be edited at the particular instant. Measurements are only editable if the observation has been manually entered.

Press **OK** to confirm or **Cancel** to abort the function.

Delete Observations

Enables you to delete observations from the database. An observation may be a processed baseline or a manually entered terrestrial observation from the Adjustment component.

1. Highlight an observation and select **Delete** and then **Observation** from the context menu or from the **View/Edit** or **Adjustment** main menu.

Note: If more than one Observation exists, you will be prompted.

2. Press **Yes** to confirm or **No** to exit without deleting.

Tip/Note:

- GPS raw data are NOT deleted if you delete a baseline.
- If you select a series observations all of them can be deleted at once.
- If you want to delete an observation (baseline) that consists of more than one track, a dialog box appears allowing you to select individual tracks.

Re-assign TPS observations

Enables you to re-assign one or more TPS Survey observations to another TPS setup.

- In the  **View/Edit** tabbed view right-click on the point on which the TPS Survey observations to be re-assigned have been measured and select **Re-assign TPS observation...** from the context menu.

The **Re-assign TPS Observations Wizard** starts up:

1. If more than one TPS setup exists on the selected point then in the **Start** page of the wizard select the TPS setup on which the **Survey observations** to be re-assigned have been measured. Click **Next**.
2. In the **Select Observations** page select the point to which the Survey observations shall be re-assigned from the **Move to** drop-down list. In the right-hand graphical view the selected target point is displayed together with all its existing TPS observations (including Setup and Traverse observations).

Note: Only points on which a TPS Setup exists are available in the list. **New Setups** can be created in **View/ Edit** or in the **Adjustment** component.

In the left-hand side report view select the Survey observation(s) to be re-assigned. Press the  button to add the observation(s) to the right-hand side graphical view. To remove an observation again



from the graphical view, select it in the graphical view and press the  button. Alternatively, right-click on the observation in the graphical view and select **Remove** from the context menu.

3. Click the **Finish** button to move all observations added to the graphical view to the selected TPS setup.

Observations View

The Observation View gives you an overview on all observations (GPS, TPS, Level and Azimuth observations) contained in a project. It is available in the **Adjustment** and in the **View/ Edit** graphical views.

To invoke the Observation view:

- Right-click in the background of the  **Adjustment** or the  **View/ Edit** graphical view and select **View Observations...** from the background context menu or from the main menu.

The Observations view opens up in a stand-alone floating window. It's a two-pane view offering a tree view on the left-hand side and a corresponding report view on the right-hand side.

You may select from two different tree-views.

The **From** tab lists all points (GPS, TPS, Level and/ or Azimuth setups) in a project from which observations have been made to several target points. Depending on the kind of setups contained in the project the corresponding report view offers up to four different tabs (**GPS**, **TPS**, **Level** and/ or **Azimuth**) each listing the **observation properties** for each target point that has been measured from the selected setup.

The **To** tab lists all target points contained in a project. Depending on the kind of setups (GPS, TPS, Level or Azimuth) from which the target points have been measured the corresponding report view offers up to four different tabs (**GPS**, **TPS**, **Level** and/ or **Azimuth**) each listing the **observation properties** for each setup from which the selected target point has been measured.

Example:

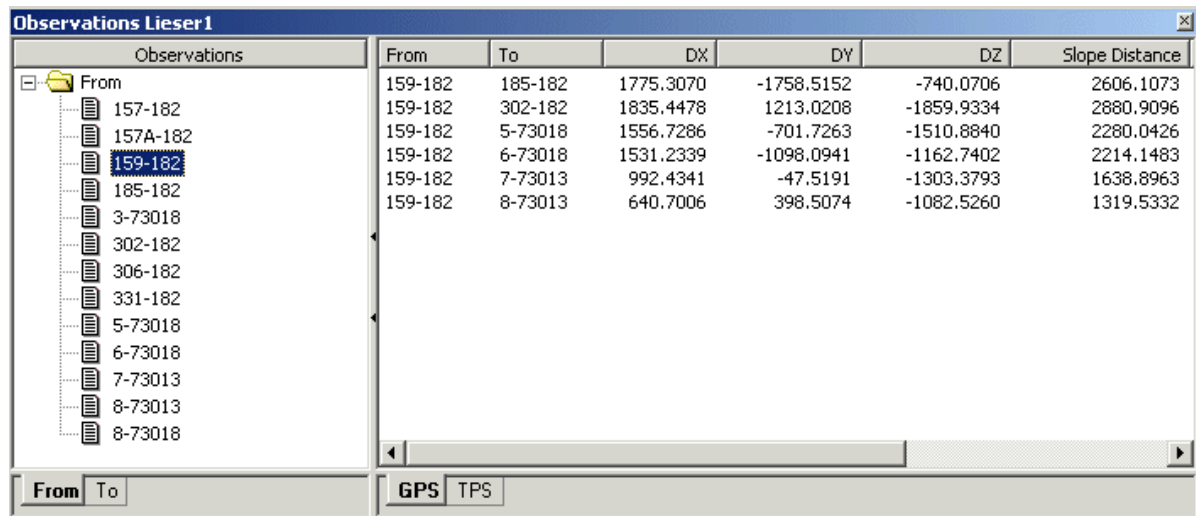

From	To	DX	DY	DZ	Slope Distance
159-182	185-182	1775.3070	-1758.5152	-740.0706	2606.1073
159-182	302-182	1835.4478	1213.0208	-1859.9334	2880.9096
159-182	5-73018	1556.7286	-701.7263	-1510.8840	2280.0426
159-182	6-73018	1531.2339	-1098.0941	-1162.7402	2214.1483
159-182	7-73013	992.4341	-47.5191	-1303.3793	1638.8963
159-182	8-73013	640.7006	398.5074	-1082.5260	1319.5332

The report views offer the following functionality:

- Select **Properties...** from the context menu to display the observation properties of the selected observation. For details see:

[Observation Properties: GPS](#)
[Observation Properties: TPS](#)
[Observation Properties: Level](#)
[Observation Properties: Azimuth](#)

Observation Properties: RTK Info

- Select **Zoom to Observation** from the context menu to zoom the graphical view to the extents of the selected observation(s).
- To delete one or more observations select the observations to be deleted and select **Delete** from the context menu.
- In the **TPS** observation tab you can modify the target height, the reflector type, the offsets and the geometrical or the atmospheric ppm simultaneously for more than one observation. Select the observations and choose **Edit Target Height...** or **Edit Reflector Type...** or **Edit Offsets...** or **Edit geometrical PPM...** or **Edit atmospheric PPM...** from the context menu.

For **single** observations the target height, the reflector type or the offsets may also be modified via the in-line edit functionality. Select the observation and right-click onto the item to be changed in its respective column. From the context menu select **Modify...** Alternatively, double-click slowly onto the item to be changed to open the in-line edit field.

Modifying the target heights updates the measured point coordinates. Modifying reflector types updates the slope distances and the measured point coordinates. Modifying offsets updates the measured TPS observation(s) and the measured point coordinates. [Modifying the geometrical ppm](#) updates the horizontal distances and the measured point coordinates. [Modifying the atmospheric ppm](#) updates the original slope distance and the measured point coordinates.

Note: Modifying target heights, reflector types or geometrical ppm values is not allowed if the observation is used in a 'Resection' or 'Multiple Backsights' setup application. You can modify target heights or reflector types in the corresponding [Setup Properties: Observations](#) page, which enforces a re-calculation of the setup. Modifying offsets is only allowed for Survey Observations.

- In the **TPS** and in the **GPS** observation tab you can modify the target/ rover point codes for one or more points simultaneously.

The thematical code of a single target/ rover point may be modified via the in-line edit functionality. Select the observation and right-click onto **Code** column. From the context menu select **Modify...** Alternatively, double-click slowly onto the code to be changed to open the in-line edit field. All point codes that are available in the Codelist of the active project will be offered for selection.

To modify the thematical code for **more than one** target/ rover point at once select the set of points to be modified, right-click into the selection and select **Edit Target Point Code.../ Edit Rover Point Code...** from the context menu. Again all point codes that are available in the Codelist of the active project will be offered for selection.

Note: Attribute values which might have been defined for the selected Target/ Rover point(s) are removed when changing the code. They would have to be re-defined for each target/ rover point in the [Point Properties: Thematical data](#) dialog page if desired.

Note:

- When you select a setup/ target point in one of the tree views the point will simultaneously be selected in the Select point combo box of the **Scroll&Query** toolbar.

Graphical Settings

Graphical Settings (View/ Edit)

The Graphical Settings Property-Sheet enables you to configure the graphical view. You may configure which items to display and select the colors of graphical elements and the font for text items.

1. From the context menu (right-click) or the **View** main menu select **Graphical Settings...**
2. In the Property-Sheet use the tabs to switch between the following pages:
 - [View](#)
 - [Accuracy](#)
 - [Grid](#)
 - [Color](#)
 - [Font](#)
3. Make your changes or press the **Default** button to apply the default values to the parameters of a page.
4. Press **OK** to confirm or **Cancel** to abort the function.

See also:

[Graphical Settings \(Adjustment\)](#)

Graphical Settings: View

This Property-Page enables you to define which graphical elements shall be displayed.

General:

Grid

Check to display a coordinate grid.

Note: To configure the grid see: [Grid](#)

North Arrow

Check to display an arrow in the upper right corner pointing to the north.

Scale Bar

Check to display a Scale Bar in the lower left corner of the screen. The Scale bar will alter its size and description to suit the scale at which you are zoomed in. Additionally, the scale bar will appear on any printout that you make, when activated.

Legend

Check to display a legend listing the point symbols of all possible point classes.

Coordinate Tracking

Check to display the mouse coordinates in the Status Line.

Background Image

Check to display the referenced image which has been attached to the project as a background image.

CAD files

Check to display the CAD files which have been attached to the project and have been activated in the [Project Properties: CAD files](#) dialog page.

Data:

Point Ids

Check to display the Point Identifications

Note: To configure the font see: [Font](#). To configure the color see: [Color](#).

Height Value

Check to display the Height Values. If the view is configured to display *local grid* coordinates either the *orthometric* or the *ellipsoidal* height value is displayed **depending on** the choice you made in the [Tools-Options: Units/ Display](#) dialog page.

Note: Only if the requested height mode is available will a height value be displayed. Height values are only displayed if the font for **Point Id** is a  True Type font. To configure the font see: [Font](#).

Thematical Codes

Check to display the Thematical Code

Note: Thematical Code values are only displayed if the font for **Point Id** is a  True Type font. To configure the font see: [Font](#).

Abs. Error Ellipses

Check to display the point accuracy indicators. The point accuracy is represented by the corresponding error ellipse (which represents the two-dimensional 1-sigma confidence region of the point) and the standard deviation of the height (1-sigma confidence region).

Note: To configure scale and color of the accuracy indicators see: [Accuracy](#).

GPS Observations

Check to display the GPS baseline vectors

Note: To configure the color of the baseline vectors see: [Color](#).

TPS Observations

Check to display the TPS (direction and distance) measurements

Note: To configure the color of the TPS observations see: [Color](#).

Azimuth Observations

Check to display the Azimuth measurements

Note: To configure the color of the Azimuth observations see: [Color](#).

Level Observations

Check to display the height difference observations

Note: To configure the color of the Level observations see: [Color](#).

Lines

Check to display all Line objects

Note: To configure the style, color and width of the Line objects see: [Line/ Area Properties](#).

Areas

Check to display all Area objects

Note: To configure the border and shading styles of the Area objects see: [Line/ Area Properties](#).

Avg. Limit exceeded

Check to display a hatched rectangle for points containing measured coordinate triplets that exceed the averaging limit.

GPS Tracks

Check to display Mixed (MXD) or Kinematic chains (tracks).

Note: To configure the color of the tracks see: [Color](#).

GPS Hidden Point Measurements

Check if you want to have details of the Hidden Point calculation displayed in the View/ Edit window.

Level Tracks

Check to display the track along all turning points of a level line, which have position information stored.

Note: To configure the color of the tracks see: [Color](#).

Geoid Contours

Check to automatically calculate and display contour lines of the geoid for the extents of your project.

Note: This option is only available if a coordinate system including a [Geoid Model](#) is attached to the project. The contour lines will be removed if the attached coordinate system changes.

As geoid separations are always stored with respect to the local ellipsoid, contour lines can only be displayed if the view is [configured to Local](#).

Linked images

Check if you want to indicate via a special point symbol if images are attached to a point. The point symbol for linked images is pre-defined and cannot be changed in its representation. If selected the linked images symbol is superimposed on any other point symbol (e.g. on the symbol for the point classes *Measured* or *Control*).

Graphical Settings: Accuracy

This Property-Page enables you to set the scale and color of the point accuracy indicators.

The point accuracy is represented by the corresponding error ellipse (which represents the two-dimensional 1-sigma confidence region of the point) and the standard deviation of the height (1-sigma confidence region).

Abs. Error Ellipses

Enter a value between 0.00001 – 1 to set the scale of the point accuracy indicators.
Select a color from the combo box.

Graphical Settings: Color

This Property-Page enables you to set the color of the database items.

- In the **Color** column double-click onto the corresponding color field and select a color from the in-line edit combo box.

Selected Objects

Select a color from the in-line edit combo box to set the color of selected point symbols and observations.

De-activated Objects

Select a color from the in-line edit combo box to set the color for de-activated point symbols and observations.

Point Symbols

Select a color from the in-line edit combo box to set the color of the point symbols.

GPS Observations

Select a color from the in-line edit combo box to set the color of the GPS baselines.

TPS Observations

Select a color from the in-line edit combo box to set the color of the TPS measurements.

Setup/ Traverse Observations

Select a color from the in-line edit combo box to set the color of the Setup and Traverse measurements.

Azimuth Observations

Select a color from the in-line edit combo box to set the color of the azimuth measurements.

Level Observations

Select a color from the in-line edit combo box to set the color of the direct leveling measurements.

GPS Tracks

Select a color from the in-line edit combo box to set the color of Mixed (MXD) or Kinematic chains (tracks).

GPS Hidden Point Measurements

Select a color from the in-line edit combo box to set the color of the **Hidden Point** measurements.

Level Tracks

Select a color from the in-line edit combo box to set the color of the Level Tracks.

Background

Select a color from the in-line edit combo box to set the color of the view's background.

Re-assign TPS Setups

Enables you to re-assign one or more Setups and all connected [Setup-](#) or [Survey observations](#) to another Point Id.

1. In the **View/Edit** tabbed view right-click on the point on which the Setup(s) to be re-assigned exist(s) and select **Re-assign TPS setups...** from the context menu.

In the **TPS-Proc** View right-click on the Setup Application to be re-assigned. Only **single** Setup Applications can be re-assigned.

In the dialog **Re-assign TPS Setups**:

1. If there exists more than one Setup on the selected point, select the setup(s) to be re-assigned from the list or press **Select All**.
2. Under **From Point Id xx to** select a Point Id to which the setup(s) shall be re-assigned from the list of available points or enter a **new** Point Id.

Note: A setup cannot be re-assigned to one of its own target points, thus the target points of the selected setup do not appear in the list for selection.

3. Press **OK** to confirm or **Cancel** to abort the function.

If a setup shall be re-assigned to a point on which there already exists a *Reference* triplet, then the difference between the two *Reference* triplets will be calculated and all rover/ target coordinates that are connected with the setup(s) to be re-assigned will be shifted by the same amount.

If a setup shall be re-assigned to a point on which there does **not** exist a *Reference* triplet, then a **new** *Reference* triplet will be created with the same coordinates as the **current** triplet of the point to which the setup(s) shall be re-assigned.

If a **new** Point Id is entered as the point to which the setup(s) shall be re-assigned, then the *Reference* triplet to be created at this new point will be the same as the *Reference* triplet existing on the point from which the setup(s) shall be re-assigned.

See also:

[Re-assign Reference Triplets](#)

Re-assign Reference Triplets

Enables you to re-assign a single Reference point triplet and all connected observations to another Point Id.

1. In the **View/Edit** tabbed view right-click on a point for which a Reference triplet exists and select **Re-assign Triplets** and then **Reference**.
2. In **From Point Id xx to** select a Point Id to which the Reference triplet should be re-assigned from the list of available points or enter a new Point Id.
3. Press **OK** to confirm or **Cancel** to abort the function.

Only one Reference triplet can exist for a point. In case a Reference triplet already exists for the point to which the reference shall be re-assigned, then the difference between the two Reference triplets will be calculated and all rover/ target coordinates that are attached to the reference to be re-assigned will be shifted by the same amount.

Whereas GPS references are always stored with WGS84 coordinates, the reference triplet of a TPS setup is typically stored with Local Grid coordinates. A coordinate system must be attached if you wish to re-assign a TPS to a GPS reference or vice versa. If a **coordinate system is missing** then a warning message will be displayed and you can cancel the operation or allow for the re-assigning of the reference triplet without shifting the connected target/ rover points.

Note:

- Only the coordinate triplet of class Reference is re-assigned to the new Point Id. If other triplets exist for the point to be re-assigned, these will remain.
- All observations (GPS baselines, TPS observations, Height difference observations) and setups will be connected to the new Point Id.
- GPS Intervals remain with the original Point Id. If you wish to also re-assign the GPS interval (and together with it the navigated point triplet) then select **Re-assign Interval**.
- When changing a GPS reference triplet by more than 10m it is recommended that you re-process the data. In order to do so, raw data must be available. In re-processing the data the possibility of scaling errors can be avoided.

See also:

[Re-assign Measured Triplets](#)

[Re-assign Intervals](#)

Re-assign Measured Triplets

Enables you to re-assign a single Measured point triplet to another Point Id. E.g. if the same Point Id was given to two different points.

1. In the **View/Edit** tabbed view right-click on a point for which at least one Measured triplet exists and select **Re-assign Triplets** and then **Measured**.
2. If for the selected point more than one Measured triplet is stored, select the measurement to be re-assigned from the list or press **Select All**.
3. In **From Point Id xx to** select a Point Id to which the measurement should be re-assigned from the list of available points or enter a new Point Id.
4. Press **OK** to confirm or **Cancel** to abort the function.

Note:

- Only the coordinate triplet of class Measured is re-assigned to the new Point Id. If other triplets exist for the point to be re-assigned, these will remain.
- Observations (GPS baselines, TPS observations, Height difference observations) will be connected to the new Point Id together with the Measured point triplet.
- GPS Intervals remain with the original Point Id. If you wish to also re-assign the GPS interval (and together with it the navigated point triplet) then select **Re-assign Interval**.
- The functionality to re-assign Measured triplets is also available in the context-menu of the **Level-Processing booking sheet** to rename the start or end point or any turning point of a level line to a point for which already a level measurement exists.

See also:

[Re-assign Intervals](#)

[Re-assign Reference Triplets](#)

Assign/ Remove points to/from a surface

Points stored in the project can be assigned to a surface or can be removed from a surface. When assigning or removing points the surface and its configured volume is instantly re-calculated.

To assign points to an existing surface:

Points in the project which are not belonging to a surface may be **assigned** to a surface if necessary.

- In the **Surfaces** view make sure **Unassigned Points** are **enabled** to be displayed for the **2D view**. In the 2D View select one or more points and select **Assign to**. If more than one surface is activated within the project select the surface to which the point(s) shall be assigned.

Alternatively points can also be assigned to an existing surface from within the **View/Edit** or **Points** tabbed view. Highlight the points and select **Assign to surface** from the context-menu.

To remove points from a surface:

Points belonging to the **active** surface(s) may be **removed** in the **2D View** or in the **Points** view.

- Select the point(s) to be removed. Then select **Remove (Point)** from the context/ background menu.

Removed points are removed from the surface but remain stored in the project. They may be **assigned** to the surface again if necessary. They will not show up in the Points view any longer.

Note:



- The current triplet of the points will be used for the triangulation. It must either be stored with *Local Grid* coordinates or the coordinate system attached to the project must allow to convert the point to *Local Grid* coordinates. Only points with *Position and Height* information can be included in surface calculations.
- **Unassigned Points** can be switched on or off for display in the Settings view on the left-hand pane of the window. The color of Unassigned Points can be selected in the **Graphical Settings: Color** dialog.

Show Direction & Distance

This command enables you to calculate Direction, Distance and Height Difference between two points. Depending on the selected coordinate system (*WGS84* or *Local*) the Distance and Height Difference will be *Ellipsoidal* or *Grid* and the direction will be either *Geodetic Azimuth* or *Grid Bearing*.

1. From the Context-Menu (right-click) or from the **View/Edit** main menu select **Show Direction & Distance**.
2. Select the start point (**From point Id**) and end point (**To point Id**) from the list or by clicking on the points in the graphical view. To switch between start and end point click on the appropriate button.
3. The Azimuth (Bearing), Distance, Height Difference and the Slope Distance between the two selected points will be displayed.

Tip:



- Use the Coordinate Format toolbar to switch between WGS84 and Local coordinate systems. Select between  and  or use **Ctrl-W** or **Ctrl -G** to switch between *WGS84* and *Grid*.

Show GPS Loop Misclosure

Show GPS Loop Misclosure

This command enables you to compute the misclosure of a loop of post-processed baselines and/or baselines measured in real-time.

1. From the Context-Menu (right-click) or from the **View/Edit** main menu select **Show Loop Misclosure**.
2. Select the baselines graphically by clicking on them in the graphical display. The baselines will be highlighted and the points will be listed under **Loop points**. If the last baseline (connecting back to the start point) is selected the computation will start automatically.

Or
In the **General** page select the **Start point** and then all the **Next point(s)** in the loop from the combo box. To finish the entry and start the computation of the loop, select the start point again.
3. If necessary click on the **Settings** tab and enter the criteria for marking loops. Loops exceeding these criteria will be marked with  in the Report tab.
4. To list the results in a **Report-View** click the **Report** tab.
5. To close the Loop Misclosure dialog click on  in the upper right corner of the Property-Sheet.

Select from the list below to learn more about Loop Misclosure:

[General](#)

[Settings](#)

[Report](#)

Note:

- You determine the loop. It may comprise one or more independent loops.
- To automatically process all independent loops in a network go to the **Adjustment** view and select **Compute Loops** from the context-menu.

Tip:

- Several loops may be calculated and listed in the Report tab.
- In the Report tab right-click and select **Print...** to generate a printout of the loop results.
- In the Report tab right-click and select **Save as...** to save the result to an ASCII file.
- In the Report tab right-click and select **Delete** or **Delete all** to delete individual or all loop results.
- In the Report tab right-click on a loop and select **Properties** to list the properties of all baselines involved in the selected loop.

Show GPS Loop Misclosure: General

Lists the elements of the current loop misclosure calculation.

Start point: (Next point:)

Enables you to select the point for a loop misclosure calculation from the list.
To finish the loop entry and start the calculation select the starting point again.

Loop point:

Lists all points involved in the Loop Misclosure calculation.

Misclosure:

Displays the Loop Misclosure (Sum of all baselines vectors of the loop)

ppm:

PPM is the Loop Misclosure in Millimeters divided by the total length of all baseline vectors of the loop.

Ratio:

The Ratio is the total length of all baseline vectors divided by the Loop Misclosure. Note: Ratios larger than 1 Million are displayed as >1000000.

dLat:

Displays the Latitude component of the sum of all baseline vectors.

dLong:

Displays the Longitude component of the sum of all baseline vectors.

dHgt:

Displays the Height component of the sum of all baseline vectors.

Show GPS Loop Misclosure: Settings

Enables you to set criteria for marking Loops. Loops Misclosures exceeding these criteria will be marked with  in the [Report](#) tab.

Absolute + relative:

Click the checkbox and enter an absolute and a relative value. If the *Misclosure* of a loop exceed these values the loop will be marked  in the Report tab.

Ratio:

Click the checkbox and enter a value. If the *Ratio* of a loop is below this value the loop will be marked with  in the Report tab.

Note:

- If both criteria are selected the loop will be marked as soon as one of the criteria is not met.

Show GPS Loop Misclosure: Report

Displays the results of the Loop Misclosure calculation in a Report-View. The Report-View allows you to list several different loops at the time.

The results in the Report-View may be deleted, printed or stored as an ASCII file. See [Report-View](#) for more information.

Loops exceeding the criteria set in the [Settings](#) page will be marked with .

Compute Average Combined Factor

This function allows you to compute the average Combined Scale Factor for selected points in your project. It is only accessible, if **View/Edit** is the active project window, if one or more points are selected and if the coordinate system attached to the project contains a map projection of type Transverse Mercator, UTM, Lambert two or Double Stereographic.

1. With such a coordinate system attached to the project, go to the **View/ Edit** page and select the points for which you want to compute the **average Combined Scale Factor**. Then proceed to the main menu and activate **View/Edit – Compute Ave. Combined Factor**.
2. A new window appears which shows the average scale factors for the selected points. These are the average projection, the average elevation and the **average Combined Scale Factor**.
3. Tick the checkbox, if you want to apply this **average Combined Scale Factor** to the active project. When doing so you will be able to obtain **Modified** Grid Coordinates (Easting and Northing) using this factor. To clearly differentiate the modified grid coordinates from the ordinary grid coordinates you may then also enter a Northing shift and an Easting shift. The average Combined Scale Factor and the shift values will be stored as a **project property**.

The modified grid coordinates are displayed in the **Points View** and may be exported using the **ASCII export** utilities.

Shift/ Rotate/ Scale

The **Shift/ Rotate/ Scale** wizard enables you to transform a set of **grid** coordinates into new coordinates using a *Classical 2D Helmert* transformation for the **position** and a *shift* for the **height** component.

The **parameters** of the transformation can either:



- be entered manually
- be computed independently (by comparing a set of points)
- be derived from a rigorous Helmert transformation.

The transferred **grid** coordinates replace the existing **grid** coordinates of the selected points. If you want to keep the original grid coordinates, too, you should create a **backup** copy of your project first.

Note:

- Only coordinates stored as **local grid** can be transformed.
- You can be sure that setup and target points will only be transformed **together**. It is **not** possible to transform only the setup coordinates or only the target coordinates of TPS observations.

To invoke the wizard:

- Select the points to be transformed either graphically in the  **View/Edit** tabbed view or in the  **Points** view of your project and select **Shift/Rotate/Scale...** from the corresponding main menu or from the background menu.

Depending on the **method** that shall be used for calculating the shift, rotation and scaling parameters you will be guided through the following wizard pages:

Enter manually or calculate separately:

Shift/ Rotate/ Scale Wizard - Start

Shift/ Rotate/ Scale Wizard - Shift

Shift/ Rotate/ Scale Wizard - Rotation

Shift/ Rotate/ Scale Wizard - Scale

Shift/ Rotate/ Scale Wizard - Transformation parameters

Shift/ Rotate/ Scale Wizard - Finish Transformation

Calculate using Common Points:

Shift/ Rotate/ Scale Wizard - Start

Shift/ Rotate/ Scale Wizard - Transformation parameters

Shift/ Rotate/ Scale Wizard - Common Points

Shift/ Rotate/ Scale Wizard - Transformation parameters

Shift/ Rotate/ Scale Wizard - Finish Transformation

Tip:

- If you want to use **Filter Settings** to select the points, set the filter criteria as required and apply them to **activate** a subset of points. Afterwards select **Select checked items** from the **Points** context menu to **select** the active subset of points as input to the Shift/ Rotate/ Scale wizard.

Exchange Coordinate System (Smart Station)

This command enables you to recalculate the station coordinates of a TPS setup or the coordinates of a set of points if the coordinate system used to derive the coordinates changes.

To exchange a coordinate system becomes necessary if your setup coordinates have been derived using a Smart Station instrument and only a preliminary coordinate system was available in the field.

To invoke the functionality:

- For a single TPS setup invoke the functionality from the **Setup Properties: General** page by pressing the  button in the lower left corner of the dialog.
- To exchange the coordinate system for one or for more than one setup select the setup(s) in the **TPS-Proc** report view and select **Exchange Coordinate System...** from the context menu or from the TPS-Proc main menu.
- You can also select a series of points in the **View/ Edit** or in the **Points** tabbed view and select **Exchange Coordinate system...** from the background context menu or from the main menu.

The **Exchange Coordinate System Wizard** starts.

Start:

In the **Start** page of the wizard you are presented with a list of all point triplets which will be recomputed. The points are given together with their local grid coordinates in a configurable report view.

- If you have selected a TPS setup in the **TPS-Proc** view, then the Reference triplet of the station setup and all connected measured point triplets will automatically be included in the list.
- If you have selected a series of points in **View/ Edit** or in the **Points** view, then the list of points is based upon the selection. It is influenced, though, by some conditions which add or remove points to or from the list as follows:
 - Only points stored with **Local Grid** coordinates are displayed. Point triplets which are **not** stored as Local Grid (but e.g. as WGS84) cannot and will not be transformed.
 - The points must have position information. **Height-only** point triplets will be **ignored**.
 - Only Point classes **Estimated, Measured, Reference, Adjusted** and **Control** will be listed.
 - Measured point triplets, **to which** an **observation** has been made, will be **removed** from the list, **if** the reference point (the TPS setup point) from which the observation has been made is **not included** in the selection **either**.
 - If you have selected a **Reference** point triplet, then **all** connected measured point triplets will automatically be included in the list.

By this selection mechanism it is ensured that setup and target points are always **transformed together**. Inconsistencies are avoided.

Coordinate System selection:

In the **Coordinate System selection** page of the wizard:

- Determine the **old** and the **new** coordinate system. All coordinate systems stored in the **Coordinate System Management** (except WGS1984 and None) are offered for selection.
- Decide if you want to **Keep the heights** of the preliminary system and transform only the position to the new coordinate system.

- Decide if you wish to **Attach the new coordinate system to the project**. This is recommended to ensure that any GPS measured points fit to the newly transformed TPS points.

Finish:

In the **Finish** page of the wizard the new local grid coordinates are listed for all point triplets. They are derived by transforming the original grid coordinates to **WGS84** using the **old coordinate system** and re-transforming the coordinates back to local grid using the **new coordinate system**.

- Click **Finish** to update all points in the database. The existing local grid coordinates will be replaced with the coordinates as displayed in this page.
- Click **Back** if you want to modify the coordinate systems.
- Click **Cancel** to abort the operation without any changes to your project coordinates.



Note:

- Since the backsight coordinates change together with the station coordinates for all setups of method **Set Orientation** or **Known Backsight** the orientation of the setup is updated after executing the **Exchange Coordinate System** command.

Update Reference Triplets

Enables you to update one or more *Reference* point triplets with other coordinates stored for the selected point(s). All *Measured* point coordinates of the target points connected to the selected *Reference* will then be shifted by the same amount that the *Reference* point changes.

One typical example to use this functionality is when a TPS SmartStation or any GPS Reference was set up with an approximate navigated position and the correct coordinates are only derived later using post-processing. Another example is the need to update TPS setups measured on a sideshot of a traverse (loose traverse legs) after the traverse was re-calculated.

1. In the  **View/Edit** tabbed view or in the  **Points** view right-click on a point for which a *Reference* triplet exists and select **Update Reference triplets...** from the context menu. To invoke the functionality for more than one point highlight the points and select **Update Reference triplets...** from the background menu or from the **View/Edit** or the **Points** main menu.
2. In the **Update Reference triplets** dialog the current *Reference* coordinate triplet for the selected point is displayed and all point triplets of point class *Measured*, *Averaged*, *Adjusted* and *Control* are listed in the report view. The highest triplet is already selected by default.

If more than one point was selected, scroll through the **Point Id** combo-box to select one after the other the points for which the reference triplets shall be modified. In the report view select the coordinates of another point class stored with the selected reference. The reference will be updated with the selected point triplet.

3. Press **OK** to update the *Reference* triplet(s) with the selected coordinates. All *Measured* coordinates of the target points which are connected to this/ these reference(s) will be shifted by the same amount.

Note:

- Point triplets that cannot be converted to the coordinate system and type in which the *Reference* triplet is stored, will not be listed. For example, *Reference* triplets stored with WGS84 coordinates can only be updated with *Control* triplets stored with Local Grid coordinates if a coordinate system is attached to the project.
- If more than one point was selected, the *Reference* triplets will be updated in **chronological order** (oldest first), which may result in a chain effect when another *Reference* triplet gets updated with a *Measured* point triplet derived from a previously updated *Reference*. This preserves the consistency in the project. However, if you want to avoid this chain effect, it is recommended to update the *References* separately.
- A single preliminary *Reference* triplet may also be shifted to the final point coordinates. For more information on the **Shift Reference Triplet** functionality see also [Shift Reference Triplet](#).

See also:

[Shift Reference Triplet](#)

[Re-assign Reference Triplets](#)

Shift Reference Triplet

Enables you to calculate an average shift for a *Reference* point triplet. For target points with *Control* triplets the *Measured* point coordinates can be matched with the *Control* triplets to calculate the shift for the *Reference*. After the *Reference* has been shifted all connected *Measured* point coordinates will be shifted by the same amount.

One typical example to use this functionality is when a GPS Reference was set up with an approximate navigated position and the correct coordinates can be derived by measuring one or more rover points (common points) with known (*Control*) coordinates. Another use case is when final *Measured* coordinates are received for the reference later. The *Navigated* coordinates of the reference may then be shifted to the *Measured* point triplet. See also: [Update Reference Triplet](#).

- In the  **View/Edit** tabbed view or in the  **Points** view right-click on a point for which a *Reference* triplet exists and select **Shift Reference triplet...** from the context menu.

In the **Shift Reference triplet** dialog the current *Reference* coordinate triplet for the selected point is displayed. Underneath common points may be matched to calculate the shift.

To match common points:



1. From the drop-down list select the project in which the final coordinates of the common point(s) are stored. By default the active project will be selected.
2. In the upper left report view (System A) select the preliminary coordinate triplet of the point to be matched.
3. In the upper right report view (System B) double-click onto the correct coordinate triplet of the point to be matched. Only those triplets are offered for selection which are either **stored** in or can be **converted** to the coordinate system in which the *Reference* triplet is stored.
4. Both coordinate triplets will be **matched** and the shift will be calculated. Both points will be listed as **Point Id A** and **Point Id B** in the bottom report view.
5. Repeat steps 2. and 3. until all points (at least one point) are matched. The shift is **re-calculated** with each additionally selected and matched common point. The bottom view indicates the **differences** between the single shifts and the calculated average shift in the columns **dE**, **dN**, **dH**. The calculated average **Shift** value is displayed at the bottom of the dialog page.

Note: To remove a pair of matched points right-click onto the pair of points and select **Delete** from the context menu.



6. To apply the shift to the current *Reference* coordinates leave the dialog with **OK**. All *Measured* coordinates of the target points which are connected to the reference will be shifted by the same amount.

Scroll to a selected Point

This function scrolls the view to display a selected point in the center of the screen.

1. Select a point in the graphical window or from the points List-box  on the Toolbar.
2. On the Toolbar click the **Scroll to selected point**  button.

Alternatively:

- Select a baseline and press  to scroll to the rover point of the baseline.
- Hold down the Shift key while selecting a baseline and press  to scroll to the reference point of the baseline

Select a series of Points / Observations

To select a series of points or observations in a graphical view use one of the following methods:

- Drag a rectangle around the items you want to select. To do so in the **Panning** mode keep the Shift-key pressed while clicking with the left mouse button into the view's background and keeping the mouse button pressed while dragging a rectangle to the lower right-hand-corner. The content of the rectangle will be selected. When **Panning** is **switched off** you need not keep the Shift-key pressed.

Alternatively: Press **Ctrl-A** to select **All**.

- Keep the **Ctrl**-key or the **Shift**-key pressed while selecting individual items. You may select either points or observations, never a mixture.
- Keep the **Ctrl**-key or the **Shift**-key pressed while dragging individual rectangles around items. Points and observations inside the rectangles are selected.

To select a series of data items in a report view use one of the following methods:

- Click on an item, keep the **Shift**-key pressed and click on the last item. All the items in between will be selected.
- Keep the **Ctrl**-key pressed and select individual items. Press **Ctrl-A** to select **All**.

Alternatively: Use the Find function to select a series of items that match a particular search string.

Lines and Areas

Lines and Areas

With SmartWorx it is possible to collect Line and Area objects in the field. LGO supports this feature in offering you a graphical display of lines and area objects in the **View/ Edit** component. You can import Lines and Areas to a project, view and edit the object properties and make any corrections to the data before passing the information further on. You may also create new Lines and Areas from existing points.

- To display Lines and/ or Areas select **Graphical Settings** from the background context menu and tick the corresponding check boxes in the **Graphical Settings - View** page.

Usually, the line/ area style has already been defined in the field by the line or area code definition. If you have collected lines and areas without using codes you have the possibility to set **Color** properties and **Shading** styles in the office.

If the properties of a Line or Area code in the project specific codelist are changed all these changes to the code are applied to all objects which have that code attached.

Select from the list below to learn more about handling Lines and Areas in LGO:

[New Line/ Area](#)

[Line/ Area Properties](#)

[Add Points to Line/ Border](#)

[Remove Points from Line/ Border](#)

[Create arc from previous to next point](#)

[Graphical Settings: View](#)

[Codelist Management](#)

[Codelist Type SmartWorx](#)

[Code](#)

[Code Properties](#)

Lines/ Areas View





The Lines/ Areas View gives you an overview on all lines and areas contained in a project. It is available in the **View/ Edit** graphical view.

To invoke the Lines/ Areas view:

- Right-click in the background of the  **View/ Edit** graphical view and select **View Lines/ Areas...** from the background context menu or from the main menu.

The Lines/ Areas view opens up in a stand-alone floating window. It's a two-pane view offering a tree view on the left-hand side and a corresponding report view on the right-hand side.

The tree offers two tabbed views, one for all the **Lines** and one for all the **Areas** contained in the project.

- If  **Lines** is selected then for all lines in the project the **Line properties** are displayed in the corresponding report view.
- If an **individual**  Line is selected then for all the points belonging to this line the **Point properties** are listed in the corresponding report view.
- If  **Areas** is selected then for all areas in the project the **properties** are displayed in the corresponding report view.
- If an **individual**  Area is selected then for all the points belonging to this area the **Point properties** are listed in the corresponding report view.

Example:

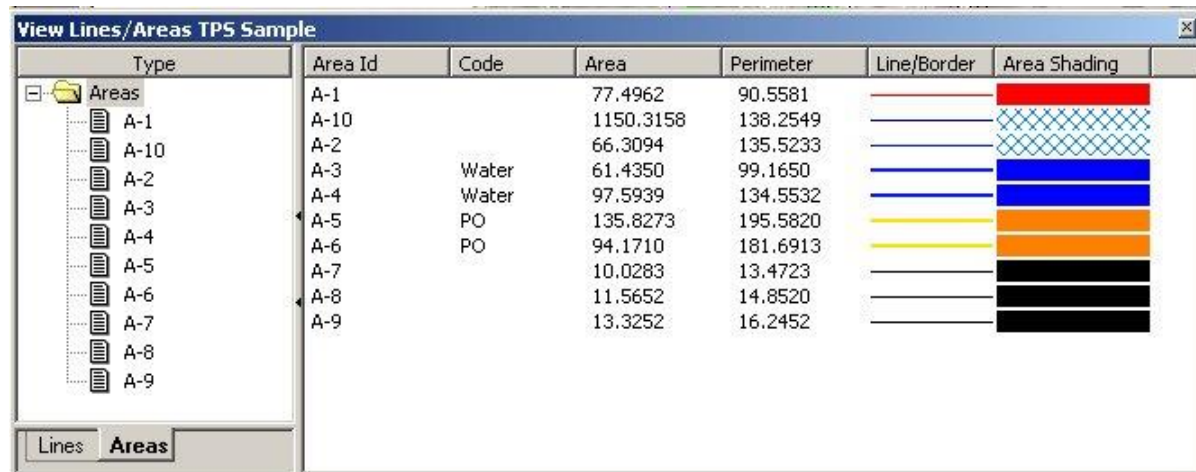

Type	Area Id	Code	Area	Perimeter	Line/Border	Area Shading
Areas	A-1		77.4962	90.5581	Red line	Red fill
	A-10		1150.3158	138.2549	Blue line	Blue cross-hatch
	A-2		66.3094	135.5233	Blue line	Blue cross-hatch
	A-3	Water	61.4350	99.1650	Blue line	Blue fill
	A-4	Water	97.5939	134.5532	Blue line	Blue fill
	A-5	PO	135.8273	195.5820	Yellow line	Orange fill
	A-6	PO	94.1710	181.6913	Yellow line	Orange fill
	A-7		10.0283	13.4723	Black line	Black fill
	A-8		11.5652	14.8520	Black line	Black fill
	A-9		13.3252	16.2452	Black line	Black fill

The **Lines/ Areas** report view offers the following functionality:

- Select **Properties...** from the context menu to display the Line/ Area properties of the selected line or area. For details see:
 - [Line/ Area Properties: General](#)
 - [Line/ Area Properties: Thematical Data](#)
- Select **Zoom to Line/ Area** from the context menu to zoom the graphical view to the extents of the selected line or area.

- To delete one or more Lines/ Areas without deleting the points defining the line/ area select the line or area to be deleted and select **Delete** from the context menu.

If an **individual** line/ area is selected then the report view offers the following functionality:

- Select **Properties...** from the context menu to display the Point Properties of the selected point. For details see:

Point Properties: All

- Select **Add point to line/area ...** from the context menu to add an existing point to the selected line/ area. Points are always inserted in the direction of the line. In the report view right-click on the point directly after which a point shall be inserted into the line. In the dialog **Add point to line/area** select the point to be inserted from the combo box and leave the dialog with **OK**.
- Right-click on a point in the report view and select **Remove point from line/area** from the context menu to remove the selected point from the line or area.
- Select **Create arc from previous to next point** from the context menu to create an arc from the previous point to the next point through the selected point. To remove the arc select **Convert arc to straights** from the context menu of the second point of the arc.
- To create a spline between two specified points select the start and the end point of the spline simultaneously and select **Create spline between points** from the context-menu.
- To delete one or more points select the point(s) to be deleted and select **Delete** from the context menu.

Note: The points in the report view will always be sorted such that the first point in the report view corresponds to the start point of the line/ area and the last point in the report view corresponds to the end point of the line/area.

The following functionality is available in the **Lines/ Areas** report view as well as in the report view for **individual** lines/areas:

- Right-click on a line/ area or on any individual point in a line/ area and select **Create spline (for all points)** from the context menu to convert the line into a spline.
- Right-click on a line/ area or on any individual point in a line/ area and select **Convert (all) spline(s) to straights** from the context menu to revert all spline segments into a line consisting of straight segments. This command is only available if the selected line contains spline segments.

New Line/ Area

This command allows you to create **new Lines** or **Areas** in  **View/ Edit**.

To create a new Line or Area proceed as follows:

1. Select **New - Line** or **New - Area** from the **View/ Edit** main menu or right-click and select **New - Line** or **New - Area** from the background menu.
2. Start the new Line or Area on any point in the project. The line or border of the area will be drawn according to the default settings.
3. Select one after the other the points that shall belong to the new line or area.
4. When the line or area that shall be created is complete, right click and select **Enter** from the context menu. The line/ border line will be created according to the default settings for the **Line/ Area Properties**.

To change the graphical representation of the line/ border line select **Enter & Edit** from the context menu. Make your changes in the **Line/ Area Properties** dialog.

To abort the creation of the Line/ Area select **Cancel** from the context menu.

Note:

- You may **create an arc** within an existing **Line** or **Area** from three points on the line/ area by using the **View/ Edit** context menu.

Delete: Lines and Areas

Enables you to delete a Line or Area object without deleting the points defining the line/ area.

To delete a Line/ Area:

1. Select a Line/ Area (left mouse-click) and select **Delete - Lines/ Areas** from the background context-menu or from the **View/ Edit** main menu.

Alternatively: Right-click onto the line/ area border and select **Delete** from the context-menu.

2. Press **Yes** to confirm or **No** to exit without deleting.

Note:

- To delete more than one Line and/ or Area object at a time select the lines/ areas to be deleted (hold the **Ctrl**-key pressed while you select the lines/ areas with left-mouse clicks, press **Ctrl-A** to select **All**) and select **Delete - Lines/ Areas** from the context-menu or from the **View/ Edit** main menu.

Line/ Area Properties: General

Usually the line/ border style has been defined by the line/ area code definition which was associated with the object in the field. For lines/ areas without codes it is possible to define Line/ Area properties (style, color and width) in the office.

- To view and edit the line/ area properties right-click on the line object or the border of the area object and select **Properties...** from the context menu.

Note: You must **select the border** of an area to select the object. When you invoke the context menu within an area the object is **not** regarded as selected and the background context menu will be offered to you for further selection of functionality.

Note:

- If two or more line/ area objects share a segment and you invoke the **Properties** on the shared segment then the IDs of all the lines/ areas will be listed in the **Line/ Area Id** combo box.
- If the properties of a **Line/ Area code** in the **project specific codelist** are changed all these changes to the code are applied to all objects which have that code attached.

In the **Line/ Area properties** dialog you may view and edit the following items:

Line/ Area Id:

In this combo box the IDs of the selected line(s)/ area(s) are listed. Select one ID to view/ edit the corresponding properties.

Line/ Area Code:

Lists the line/ area codes as defined in the Project codelist. If you select a line/ area code from this combo box, the **Border Style**, **Color** and **Width** are set according to the line/ area code and the corresponding combo boxes become read-only. The line/ area code controls the style, color and width properties as defined by the codelist.

If you select line/ area code **None** then the style, color and width properties become editable.

Line/ Border Style:

Lists all supported line/ border styles (solid, dash, dot and dashdot combinations).

Line/ Border Color:

Lists all supported line/ border colors (all colors and color shadings as well as all grey shadings).

Line/ Border Width:

Lists all supported line/ border widths (from 1/4 pt to 6 pt).

Line Length (Line properties only):

Shows the length of the line in the **selected linear units**.

Shading Style (Area properties only):

Lists all supported shading styles. The shading style defines the pattern with which the area is filled. If you want the area to be fully filled (without a pattern) select the 'blank' shading style, i.e. the first option in the list.

Shading Color (Area properties only):

Lists all supported shading colors (all colors and color shadings as well as all grey shadings).

Length of Perimeter (Area properties only):

Shows the length of the perimeter in the **selected linear units**.

Area Enclosed (Area properties only):
Shows the area in the square of the [selected linear units](#).

See also:

[Line/ Area Properties: Thematical Data](#)

[Line/ Area Properties: Images](#)

Line/ Area Properties: Thematical Data

This Property-Page enables you to display/edit the Thematical Coding information of the selected line/ area. If Thematical Codes have been used in the field for data collection the associated Codelist is automatically transferred to the project during data import.

Note:

- If you want to change the thematical code of a line/ area you can only select Codes that are defined in the project specific Codelist. To create new Codes and Code Groups use the [Codelist Tab](#).
- If the properties of a line/ area code in the [project specific codelist](#) are changed all these changes to the code are applied to all objects which have that code attached.

Line/ Area Id:

Shows the line/ area identification as read-only.

Code Group:

Shows the attached Code Group. To change, select a different Code Group from the combo box.

Code:

Shows the attached Code. To change select a different Code from the combo box.

Description:

Shows the Description of the Code as read-only.

Attributes:

Lists the Attributes of the attached Code.

Type:

Shows the Attribute Type depending on which item is selected under Attributes. The following types are possible: **Text**, **String**, **Integer** or **Real**

Value:

Shows the value of the Attribute. To change, enter a new value or choose a value from the combo box.

Note: If the Attribute is set to *fixed* the **Default** value is shown and the value cannot be changed.

See also:

[Line/ Area Properties: General](#)

Point, Line/Area, Setup Properties: Images

In this Property-Page all images linked to the selected **Point** or **Line/Area** or **TPS Setup** are given in an embedded thumbnail view together with the filename of each image and the date and time when the picture has been taken.

Note:

- This Property-Page is only available if there are images linked to the selected object.

If more than one image is linked to the selected object you may adjust the size of the thumbnails in the embedded view to be able to see more than one thumbnail at a time.

When you select an image a context menu is available from which you may choose to Open the image in the Windows default viewer or to Open the containing folder.

The Delete and Unlink functionality is available for a selection of one or more images.

Add Points to Line/ Border

In addition to the possibility to view and modify the general line and area properties you are also able to add or remove points to or from a line/ area object.

To add points to a line/ border definition:

1. Select the line/ border segment to which you want to add the point(s). Right-click onto the line segment and select **Add points to line/ area** from the context menu.
2. An indicator (*I+*) will be added to the cursor and you can click on the points you wish to add to the line / area border. As each point is selected, the line / area border is re-drawn through the newly selected point.
3. Exit the operation mode of adding points by simply right-clicking into the background.

To add points to the beginning/ end of a line:

1. Select the first/ last line segment. Right-click onto the line segment and select **Add start/ end point to line** from the context menu.
2. An indicator (*I+*) will be added to the cursor and you can click on the point you wish to add to the beginning/ end of the line. As the point is selected, the line is re-drawn starting from or ending in the newly selected point.

Note: The new start/ end segment is automatically selected so that you can directly proceed with adding another new start/ end point.

3. Exit the operation mode of adding points by simply right-clicking into the background.

Remove Points from Line/ Border

In addition to the possibility to view and modify the general line and area properties you are also able to add or remove points to or from a line/ area object.

To remove points from a line/ border definition:

1. Select the point you wish to remove from a line or border definition and select **Remove points from line/area** from the context menu.
2. Confirm with **Yes** to remove the point from the line / area border. If the point belongs to more than one line/ area a dialog offers you the choice to remove the point from all lines or only from specific lines.

Note:

- To remove a series of points from a line / area border definition select the points and select **Remove points from line/area** from the background context menu.
- A minimum of two points must remain in a line or area otherwise the object shall be deleted.

Create arc from previous to next point

This command allows you to create an arc within an existing **Line** or **Area** in  **View/ Edit**.

To create an Arc from an existing Line/Area:

To create an arc from a line/ area, the line/ area object has to consist of at least three points. The arc is always created from the previous to the next point.

- Select the point in the line/ area from which you want to create an arc. Right-click onto the point and select **Create arc from previous to next point** from the context menu.

Note: You cannot create an arc on the first or on the last point in a line since there is not a previous or a next point. In an area the first point is the same as the last point.

The arc will be calculated from the selected point, its preceding point and the following point. The **Line/ Area Properties** will be kept. If the selected point belongs to more than one line/ area select the desired line element which shall be converted into an arc from the **Create Arc from straights** dialog.

See also:

[Convert arc to straights](#)

Convert arc to straights

This command allows you to convert an arc within an existing **Line** or **Area** back to straight lines in  **View/ Edit**.

To convert an existing Arc into straight lines:

An arc of a line or area typically consists of three points or two arc segments.

- In  **View/ Edit** select one segment belonging to the arc and select **Convert arc to straights** from the context menu.

Alternatively: In the Lines/ Areas View open the report view for an individual line or area and select **Convert arc to straights** from the context-menu of the second point of the arc.

Create spline

This command allows you to create a spline within an existing **Line** or **Area** in  **View/ Edit**.

To create a spline:

- Right-click on the line/ area object to be converted into a spline and select **Create spline** from the context menu.

The line/ area will be converted into a spline between its start and end point.

To create a spline between two selected points:

1. With a left mouse-click select the point in the line/ area from which you want the spline to start.
2. Keep the CTRL-key pressed while, with a second left mouse-click, you select a second point in the line/ area on which you want the spline to end.
3. Right-click in the background of the view and select **Create spline between points** from the background menu.

The selected line/ area segments will be converted into a spline.

To create a spline segment:

- Right-click on a line/ area segment and select **Create spline segment** from the context menu.

The selected segment will be converted into a spline. This command is useful if an existing spline shall be extended by a further segment.

The spline will always be calculated according to the selected command. The **Line/ Area Properties** will be kept.

Note:

- Arcs are predominant, i.e. if you select a line which contains an arc to be converted into a spline, the spline will be created up to the first point of the arc and from the end point of the arc onwards. The arc will be kept. Points inside an arc may not be selected for the spline calculation.

Convert spline to straights

A spline can also be reverted to straight line segments.

To convert a spline to straights:

- Right-click on the spline to be converted into straight line segments and select **Convert spline to straights** from the context menu.

The spline will be reverted into straight line segments between its start and end point.

To convert a spline segment to a straight segment:

- Right-click on the spline segment to be converted into a straight segment and select **Convert spline segment to straight** from the context menu.

The selected spline segment will be converted into a straight line segment. The remaining part(s) of the spline will be re-calculated.

The conversion will always be calculated according to the selected command. The **Line/ Area Properties** will be kept.

Link or unlink Images

All images which are available in the **Images** view may be manually **linked** to **points**, **lines** or **areas** within the same LGO project.

To link one or more images from within the Images view:

1. Click onto the  **Images** top node in the tree view to see the complete collection of all available images in the corresponding thumbnail view on the right.

Alternatively, click onto the  **Not linked** node to see only those images in the thumbnail view which are not yet linked.

2. Select the images to be linked in the thumbnail view and choose **Link** either from the context menu or from the **Images** main menu.
If you know that an image is linked already to a specific point, line or area you may also open the thumbnail view for that point, line or area and select the image to be linked again from there.
3. In the **Link Image** dialog select the **Point** or the **Line** or the **Area** to which the selected image(s) shall be linked.
4. Leave the dialog with **OK**.



To link one or more images from within View/ Edit:

1. Right-click onto a point or a line or an area and select **Link image to point/ line/ area ...** from the context menu.
2. In the **Link Image** dialog all images that are available with the current project will be shown to you in a thumbnail view together with the image name.

If you want to be offered for selection just the still unlinked images check the option **Show unlinked images only**.



3. Select the images to be linked with the selected point / line/ area from the thumbnail view.
4. Leave the dialog with **OK**.

The selected image(s) will be linked to the point or line or area as specified in the **Link Image** dialog.

In the  **Images** view a node for  **Points** or  **Lines/ Areas** will be added to the tree view if it is not available yet. If a specific point or line or area does not have images linked before it will be added under its node and in the corresponding thumbnail view the newly linked images will be shown. If a specific point or line or area does already have linked images the newly linked images will be added to the thumbnail view.

In  **View/ Edit** the point symbol changes to indicate that images are linked. If all images that have been linked to a point are unlinked again the point symbol changes back to indicate the current point class.





To unlink one or more images from within the Images view:

1. Open the node for  **Points** or  **Lines/ Areas** and select a specific point or line or area from which one or more images shall be unlinked.
2. In the thumbnail view for the selected object select the image(s) to be unlinked and choose **Unlink** from the context menu.
3. Confirm the warning message that is issued with **Yes** to unlink the selected images.

To unlink one or more images from within View/ Edit:

1. Right-click onto a point or a line or an area to which images are linked and select **Properties...** from the context menu.
2. In the **Properties** dialog go to the **Images** tab and select the images to be unlinked from the selected object in the thumbnail view.
3. Right-click into the selection and choose **Unlink** from the context menu.
4. Confirm the warning message that is issued with **Yes** to unlink the selected images.

Note:

- In the  **Images** view the **Unlink** functionality is only available for specific objects. You cannot unlink images from within the thumbnail view for the  **Images** top node.
- If an image is linked to more than one object it is only moved to the  **Not linked** node in the  **Images** view when it is unlinked from **all** objects.

Graphical Settings: View

This Property-Page enables you to define which graphical elements shall be displayed.

General:

Grid

Check to display a coordinate grid.

Note: To configure the grid see: [Grid](#)

North Arrow

Check to display an arrow in the upper right corner pointing to the north.

Scale Bar

Check to display a Scale Bar in the lower left corner of the screen. The Scale bar will alter its size and description to suit the scale at which you are zoomed in. Additionally, the scale bar will appear on any printout that you make, when activated.

Legend

Check to display a legend listing the point symbols of all possible point classes.

Coordinate Tracking

Check to display the mouse coordinates in the Status Line.

Background Image

Check to display the referenced image which has been attached to the project as a background image.

CAD files

Check to display the CAD files which have been attached to the project and have been activated in the [Project Properties: CAD files](#) dialog page.

Data:

Point Ids

Check to display the Point Identifications

Note: To configure the font see: [Font](#). To configure the color see: [Color](#).

Height Value

Check to display the Height Values. If the view is configured to display *local grid* coordinates either the *orthometric* **or** the *ellipsoidal* height value is displayed **depending on** the choice you made in the [Tools-Options: Units/ Display](#) dialog page.

Note: Only if the requested height mode is available will a height value be displayed. Height values are only displayed if the font for **Point Id** is a  True Type font. To configure the font see: [Font](#).

Thematical Codes

Check to display the Thematical Code

Note: Thematical Code values are only displayed if the font for **Point Id** is a  True Type font. To configure the font see: [Font](#).

Abs. Error Ellipses

Check to display the point accuracy indicators. The point accuracy is represented by the corresponding error ellipse (which represents the two-dimensional 1-sigma confidence region of the point) and the standard deviation of the height (1-sigma confidence region).

Note: To configure scale and color of the accuracy indicators see: [Accuracy](#).

GPS Observations

Check to display the GPS baseline vectors

Note: To configure the color of the baseline vectors see: [Color](#).

TPS Observations

Check to display the TPS (direction and distance) measurements

Note: To configure the color of the TPS observations see: [Color](#).

Azimuth Observations

Check to display the Azimuth measurements

Note: To configure the color of the Azimuth observations see: [Color](#).

Level Observations

Check to display the height difference observations

Note: To configure the color of the Level observations see: [Color](#).

Lines

Check to display all Line objects

Note: To configure the style, color and width of the Line objects see: [Line/ Area Properties](#).

Areas

Check to display all Area objects

Note: To configure the border and shading styles of the Area objects see: [Line/ Area Properties](#).

Avg. Limit exceeded

Check to display a hatched rectangle for points containing measured coordinate triplets that exceed the averaging limit.

GPS Tracks

Check to display Mixed (MXD) or Kinematic chains (tracks).

Note: To configure the color of the tracks see: [Color](#).

GPS Hidden Point Measurements

Check if you want to have details of the Hidden Point calculation displayed in the View/ Edit window.

Level Tracks

Check to display the track along all turning points of a level line, which have position information stored.

Note: To configure the color of the tracks see: [Color](#).

Geoid Contours

Check to automatically calculate and display contour lines of the geoid for the extents of your project.

Note: This option is only available if a coordinate system including a [Geoid Model](#) is attached to the project. The contour lines will be removed if the attached coordinate system changes.

As geoid separations are always stored with respect to the local ellipsoid, contour lines can only be displayed if the view is [configured to Local](#).

Linked images

Check if you want to indicate via a special point symbol if images are attached to a point. The point symbol for linked images is pre-defined and cannot be changed in its representation. If selected the linked images symbol is superimposed on any other point symbol (e.g. on the symbol for the point classes *Measured* or *Control*).

GPS Processing

GPS Processing

The GPS Processing consists of two major parts, the first being the [Selection of Observation Intervals](#) including the selection of [GPS-processing Parameters](#). Most of the tasks in this part are supported by the graphical selection mechanism.

The second is the [Processing](#) itself, which is fully automatic and no user interaction is required.

- The GPS Processing may be accessed via the  **GPS-proc** Tab from within a project window.

When the GPS Processing View is entered, all observation data contained in the active project are displayed in a [Report-View](#) on the left-hand side and the corresponding graphical representation in a [Graphical View](#) on the right-hand side. The Report-View enables you to view and edit detail information of the observation intervals while the Graphical- View displays a graphical representation of each interval and allows you to select them for processing.

Two different [Processing Modes](#) are available - the user may choose the mode which best suits the requirements of the survey.

After the GPS Processing is completed the results can be viewed using the  [Results View](#).

Select from the Index to learn more about GPS Processing:

[Report-View](#)

[Graphical View](#)

[Modify](#)

[Edit Point Properties](#)

[Re-assign Intervals](#)

[Delete an Interval](#)

[Save As](#)

[Export to RINEX](#)

[Interval Properties](#)

[Select an Observation Interval](#)

[Select an Observation Window](#)

[Select a Satellite Window](#)

[Zooming](#)

[Processing Modes](#)

[Processing Parameters](#)

[Process](#)

[Graphical Settings](#)

[Results View](#)

Report View (GPS-processing)

On the left hand side of the GPS processing View the following items of the observation data is listed:

Point Id

Point Identification of the interval

Point Class

Point class of the interval

Start

Start date and time of the interval

End

End date and time of the interval

Duration

Length of interval

GNSS Type

GNSS type: GPS only or GPS/GLONASS

Type

Interval type: Static or Moving

Antenna Height

Height Reading (reduced) + Antenna offset (Vertical distance from point to phase center of antenna)



Height Measurement

Type of height reading: Vertical or Slope Distance. See also: [Antenna Height Reading](#).

Antenna Type

Antenna Type used for the observation track. See also: [Antenna Management](#).

Tip:

- Use the scroll bar at the bottom of the window to display data items other than the Point Id and Start time.
- Drag the splitter bar between the report-view and graphical view to the right to display more data items.
- The Intervals of Stop and Go or Kinematic tracks may be hidden (collapsed) by clicking on the  icon in the report-view. Click on the  icon to redisplay (expand) the collapsed intervals. Use **Collapse All** or **Expand All** from the context-menu to hide or redisplay all intervals.

Related Topic:

[Graphical View](#)

Graphical View (GPS-processing)

In the Graphical View on the right-hand side the observation tracks are displayed with their associated intervals. Grey bars  represent the duration as well as start and end time of each interval. The observation tracks can then be [selected for computation](#). Depending on the selection the color of the intervals will change according to the [Graphical Settings](#).

Different types of observations are possible and displayed as follows:

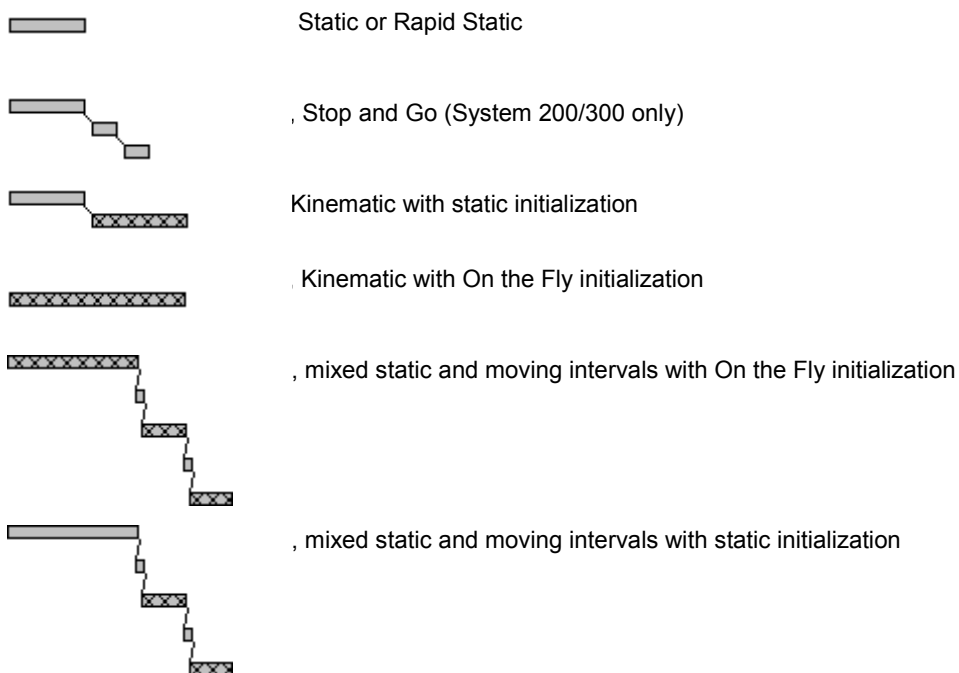

Tip:

- Drag the splitter bar between the Report View and Graphical View to the left to enlarge the Graphical View.

Related Topic:

[Report View](#)

Zooming (GPS-processing)

The original scale of the graphical view is selected in such a way that all observation intervals stored in the current project database fit onto the screen.

The Zoom function can be used to enlarge the graphical view to display more details or allow for a precise window selection.

To Zoom in:

1. In the graphical view right-click on the background and select **Zoom**, or click  on the **Toolbar**.
2. Click the left mouse button and keep it pressed while positioning the cursor to the lower right-hand-corner of the area you want to enlarge. The observation intervals within the rectangle will be enlarged to the extent of the graphical view.

To Zoom out:

In the graphical view right-click on the background and select **Zoom 100%**, or click  on the **Toolbar**. The graphical view displays all observation intervals.

To Zoom to Extent of Interval/Track:

In the graphical view right-click on an interval  and choose **Zoom to Interval**

Alternatively: Choose **Zoom to Track** if a track contains more than one interval and you want to zoom to the whole track.

Zoom to Day:

In the graphical view right-click on the background, select **Zoom to Day** and then **Selected**, to fit all observation intervals of the selected day into the graphical display. Select **Next** or **Previous** to move from one day to another.

Re-assign Intervals

Enables you to re-assign a single static observation interval to another Point Id. E.g. if the same Point Id was occupied twice using static GPS techniques.

1. Right-click on a point and select **Re-assign...**(or **Re-assign interval**)
2. If the selected point consists of more than one interval, select the interval(s) to be re-assigned from the list or press **Select All**.
3. In **From Point Id xx to** select a Point Id to which the interval(s) should be re-assigned from the list of available points or enter a new Point Id.
4. Press **OK** to confirm or **Cancel** to abort the function.

Note:

- Only static intervals can be re-assigned. Instantaneous ("time tagged") points do not have an interval connected and cannot be re-assigned (re-named) to an existing Point Id.
- You can also re-assign an interval to another Point Id by modifying the Point Id to that of an existing Point Id in the GPS-Processing interval view.

Delete an interval

1. In the report-view on the left-hand side **right-click** on an observation interval and select **Delete**
2. Press **Yes** to confirm or **No** to abort the function

Tip:

- If you select a series of Intervals all of them can be deleted at once.

Export to RINEX

Individual Intervals / Tracks within a Project may be exported to RINEX formatted files.

1. In the GPS-processing Report-View (on the left hand side) select individual or a select a series of Intervals.
2. From the Context-Menu (right-click) select **Export to RINEX...**
3. From the browser select the desired directory.
4. Modify the file name if necessary.

Note: By default a file name is suggested with the first 4 characters being equal to the station name contained in the data. The remaining characters are set automatically according to the RINEX file naming convention.

5. If you have selected more than one track and wish to write a separate file for each track then check **Separate files for different tracks.**

Note: The files will be named according to the Point Id, Day of Year and Session number.

6. Check **Ignore windows** if you wish to ignore any window selection made via [Select an observation window](#).

7. Check **Create new file every # hrs** if you want to split the files into pre-defined intervals. Enter a value between 1 and 24 hours.

Note: This function is available for static intervals only. 'Separate files for different tracks' has to be checked before this function becomes available.

8. Select the **GNSS Type** to be exported. You may choose whether you want to export **All** (GPS, GLONASS and Galileo) or **GPS L1+L2 only**.
9. Enter a name for **Observer** and/or **Agency** if you want these names to appear in the header of the RINEX observation file.
10. Press **Save** to write the files or **Cancel** to abort the function.



Related Topic:

- [RINEX File Export](#)

Select an observation interval for computation

Before you can process your baselines (or single point solutions) you have to define which intervals you want to use for processing. If you are processing baselines you have to define which interval shall be used as the reference and which interval shall be used as the rover.

Tip:

- An efficient way to select baselines is to use the Toolbar. Click **Select All**  to select all intervals as Rover, then click the **Reference Tool**  and select the interval(s) you want to use as Reference.

Select an individual observation interval

In the graphical view right-click on an interval  and choose one of the following types:

Rover
Init
Reference
SPP
or
Deselect to remove the selection

Select all observation intervals

1. In the graphical view right-click on the background and choose **Select all as**.
2. Select a type as listed above

Note: Choose **Deselect All** from the context-menu to remove all selections.

Select a series of observation intervals

1. In the graphical view right-click on the background. From **Select Mode** choose a type as listed above or select the type from the Toolbar.
2. An indicator (e.g. ) will be added to the cursor. Click on all the items you want to select as the type you have chosen,
Alternatively: Drag a rectangle around the intervals you want to select.

Select an observation window

Normally, the whole observation period of a track is used for processing. However, the user may wish to process only a subset of the observations taken on a site. Observation windows for individual observation intervals to be included or excluded can be selected.

Individual satellites can be windowed using [Satellite Windows](#).

To precisely set a window to the nearest second, it is possible to manually enter windows. This option can be activated or deactivated under [Tools – Options](#) by selecting the **GPS-processing** tab and ticking the option **Enable keyboard entry for windowing**. This is a global program setting, which applies to all projects. The last-used setting is remembered.

To select an observation window to be included or excluded with keyboard entry activated:

1. In the graphical view right-click on the background and select **Windowing**.
2. Select **Window (Include)** or **Window (Exclude)**.
3. The cursor indicator (Window) will be visible. Drag a rectangle over the period of observation that you wish to include or exclude from the computation. Immediately after a window is created with the mouse, the corresponding property page is displayed showing the full details of the window.
4. After modifying the window extents select **OK** to accept the entries. Selecting **Cancel** results in the whole windowing operation to be cancelled and no window being created.
5. The interval windows that are excluded from the selection are marked as blank spots. 

Note: Several windows per interval can be selected. The excluded parts cannot be edited.

Be aware that the “Start of window” date/ time must be earlier than the “End of window” date/ time. The duration of the window must lie within the observation interval. Otherwise a tool-tip is displayed to advise the user of the inconsistency and the OK button is disabled.

To select an observation window to be included or excluded without keyboard entry activated:

1. In the graphical view right-click on the background and select **Windowing**.
2. Select **Window (Include)** or **Window (Exclude)**.
3. The cursor indicator (Window) will be visible. Drag a rectangle over the period of observation that you wish to include or exclude from the computation. The interval windows that are excluded from the selection are marked as blank spots. 
4. If you want to edit the window afterwards right-click on the remaining subset of observations and select **Edit Window**. The Edit Window property page will appear and the start and stop times defined by the mouse can be manually refined.

Note: Several windows per interval can be selected. The excluded parts cannot be edited.

Be aware that the “Start of window” date/ time must be earlier than the “End of window” date/ time. The duration of the window must lie within the observation interval. Otherwise a tool-tip is displayed to advise the user of the inconsistency and the OK button is disabled.

To activate/deactivate an observation window:

This function allows a window selection to be de-activated (but not removed).

1. In the graphical view right-click on a windowed interval  and select **Activate Windows**.
2. Select one of the following options:
 - All in interval:** De-activates the windows of the selected interval.
 - All in track:** De-activates the windows of all intervals within a track that consists of more than one interval (e.g. MXD track).
 - All:** De-activates all windows of all observation intervals.

Note: Use the same function again to activate the de-activated windows.

Alternatively: Right-click on the background and select **Windowing** and **Deactivate all Windows** or **Activate all Windows** to temporarily deactivate or activate all selected windows of all observation intervals.

To remove an observation window:

This function allows a window selection to be permanently removed.

1. In the graphical view right-click on a window of an interval  and select **Remove Window**.
2. Select one of the following options:
 - Selected:** Removes the selected window only.
 - All in interval:** Removes all windows of the selected interval.
 - All in track:** Removes all windows of the intervals within a track that consists of more than one interval (e.g. MXD track).
 - All:** Removes all windows of all observation intervals.

Alternatively: Right-click on the background and select **Windowing** and **Remove all Windows** to remove all windows of all observation intervals.

Select a Satellite Window

- In the graphical view right-click on an interval  and select **Satellite Windows**.

A graphical view shows all the satellites of the selected observation interval. Grey bars  represent the satellite number, the duration as well as start and end time of each satellite. G denotes GPS satellites and R denotes GLONASS satellites.

This view allows the selection of windows for individual satellites.

To precisely set a window to the nearest second, it is possible to manually enter windows. This option can be activated or deactivated under **Tools – Options** by selecting the **GPS-processing** tab and ticking the option **Enable keyboard entry for windowing**. This is a global program setting, which applies to all projects. The last-used setting is remembered.

To select a satellite window to be included or excluded with keyboard entry activated:

- In the graphical view right-click on the background and select **Window (Include)** or **Window (Exclude)**.
- Drag a rectangle over the observation period of a satellite that you wish to include or exclude from the computation. Immediately after a window is created with the mouse, the corresponding property page is displayed showing the full details of the window.
- After modifying the window extents select **OK** to accept the entries. Selecting **Cancel** results in the whole windowing operation to be cancelled and no window being created.
- The interval windows that are excluded from the selection are marked as blank spots. 

Note: Several windows per satellite can be selected. The excluded parts cannot be edited.

Be aware that the “Start of window” date/ time must be earlier than the “End of window” date/ time. The duration of the window must lie within the observation interval. Otherwise a tool-tip is displayed to advise the user of the inconsistency and the OK button is disabled.

To select a satellite window to be included or excluded without keyboard entry activated:

- In the graphical view right-click on the background and select **Window (Include)** or **Window (Exclude)**.
- Drag a rectangle over the observation period of a satellite that you wish to include or exclude from the computation. The interval windows that are excluded from the selection are marked as blank. 
- If you want to edit the window afterwards right-click on the remaining subset of observations and select **Edit Window**. The Edit Window property page will appear and the start and stop times defined by the mouse can be manually refined.

Note: Several windows per interval can be selected. The excluded parts cannot be edited.

Be aware that the “Start of window” date/ time must be earlier than the “End of window” date/ time. The duration of the window must lie within the observation interval. Otherwise a tool-tip is displayed to advise the user of the inconsistency and the OK button is disabled.

To remove a satellite window:

This function allows a window selection to be removed.

- In the graphical view right-click on a window of a particular satellite 

Select one of the following options:

Remove selected Window: Removes the selected window of the selected satellite only.

Remove all Windows in Satellite: Removes all windows of the selected satellite.

Remove all Windows: Removes all the windows of all satellites.

Alternatively: Right-click on the background and select **Remove all Windows** to remove all windows of all satellites.

To Print the satellite window view:

1. In the graphical view right-click on the background and select **Print**
2. Choose a printer and select **OK** to accept or **Cancel** to abort the function

Processing (GPS)

The computation is completely hidden for the user. All selected data is processed automatically in a batch process without the need for any user interaction.

To start Processing:

- In the graphical view right-click on the background and select **Process** or select  from the Toolbar.

A Processing indicator will display the progress of the computation together with information about the currently processed baseline.

When the computation is completed, the **Results View** is displayed and the baselines that match the **Selection Criteria** (per default baselines with resolved ambiguities) are selected automatically.

Tip:

- To abort the processing press **Cancel**.
- Per default the processing is running in the foreground and after the processing is completed the Results View is displayed. This behaviour can be changed by the **GPS-Processing Options** from the Tools menu.

Processing Modes (GPS)

A selection between the following two processing modes can be made:

Manual

If the user selects the manual mode, he can configure how the data is computed. Baseline Processing and Single Point Positioning (SPP) is possible.

Automatic

If automatic mode has been selected, all logical baseline combinations according to a set of constraints will be processed automatically from the intervals that have been selected. Unlike the baseline- processing mode it is not possible to select a reference site. You can only select roving sites. LGO will automatically select suitable reference sites. For example, if you have stations 1, 2, 3, and 4 with simultaneously logged data and you select them all as roving sites for processing, then the following baseline combinations will be computed. The processing order depends on the parameters defined in [Auto. Processing Parameters](#):

Reference	-	Rover
1	-	a - 2
1	-	b - 3
1	-	c - 4
2	-	d - 3
2	-	e - 4
3	-	f - 4

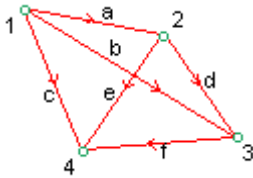

Results View (GPS)

The Results View is used to display the results of the [GPS-Processing](#). The Results View can be accessed using the **Results** tab of a Project window.

For each processing run a set of results will be created. A set of results comprises of a list of **Baselines**, a list of **Points** (rover only), a list of data-processing **Parameters** and a set of [GPS-processing Reports](#).

For each computed baseline (or SPP result) an [analysis tool](#) is available for advanced users to graphically display residuals, elevation, azimuth and DOP values.

After inspection of the data processing results you may select individual or all baselines and [store](#) them in the Project database.

By default each processing run will be named by the date and time the processing was initiated. This name can be modified. The number of processing runs that shall be retained can be set under [Results Configuration](#) (default is 3). If the number of processing runs exceeds the number set in the configuration, the oldest processing run will be deleted.

Select from below to learn more about GPS-Processing Results:

[Baseline Results](#)

[Point Results](#)

[GPS-Processing Parameters](#)

[GPS-processing Reports](#)

[GPS-Processing Analysis Tool](#)

[Modify the Name of a Processing Run](#)

[Delete a Processing Run](#)

[Keep a Processing Run](#)

[Results Configuration](#)

[Default Selection Criteria](#)

[View Configuration](#)

[Store the Results](#)

GPS-processing Parameters

GPS-Processing Parameters

Select the computation parameters before you start your computation. The parameters can be changed individually, but system default settings are also available for all parameters.

After the computation has been performed the GPS-Processing Parameter settings used for the particular computation run are listed in the Results Manager and may also be output via a report.

How to modify GPS-processing Parameters

The GPS-processing Parameter Property-Sheet consists of the following pages:

General

Auto. Processing

In the **General** page an option called 'Show advanced parameters' may be ticked, which then offers you access to two further pages:

Strategy

Extended Output

If this option has been ticked when configuring the default processing parameters under **Tools – Options**, then these two tabs will by default be visible.

GPS-processing Parameters: General

Cut-off angle:

Observations to low elevation satellites can sometimes prove to be problematic and loss of data can occur. In such cases the recommended procedure is to increase the satellite elevation cut-off angle. The system default for the elevation cut-off angle is 15°.

If there are problems with the resolution of ambiguities an increase in the cut-off angle might also improve processing. This is because cutting off the noisier low elevation satellites can reduce the overall phase noise. Care must be taken though to ensure that there still remains sufficient data with a good GDOP.

Ephemeris:

The option to use either **Broadcast** or **Precise** ephemeris is offered. If you wish to use precise ephemeris you must be aware of the fact that currently only the NOAA/NGS SP3 format is supported. **Precise** ephemeris data can be imported using the [Precise Ephemeris Import](#).

If you combine different GNSS systems and precise ephemeris are not available for all systems, then LGO switches to use broadcast ephemeris instead.

Note that when using precise ephemeris for GLONASS satellites, broadcast ephemeris must be available as well to be able to use the precise ephemeris.

Further note that Leica Geosystems is in no way responsible for providing you with precise ephemeris data.

Solution type:

This parameter defines which data shall be used for the computation and whether the phase ambiguities shall be resolved or not. You have the choice between:

- **Automatic**
- **Phase: all fix**
- **Phase: GPS fix, GLONASS float**
- **Code**
- **Float**

The default setting for this option is **Automatic**, which makes the system try to use code and phase observations for the computation and to resolve the ambiguities. Normally there is no need to change this parameter. If, for some reason, only code or phase measurements are available the system automatically switches to use exclusively these measurements for computation, i.e. choosing **Automatic** guarantees for the best possibility being selected without you having to come up for the decision.

Note: When **Automatic** is selected, GLONASS ambiguities will only be tried to be resolved if a receiver from a known manufacturer has been used, i.e. if the receiver type is known.

Whether you select **Automatic** or **Phase: all fix** should make little difference. The results should be more or less identical. Selecting **Phase: GPS fix, GLONASS float** will only attempt to resolve ambiguities for GPS satellites and keep ambiguities for GLONASS satellites at their float values. This may be required when mixing GLONASS data from different manufacturers to avoid additional biases.

Selecting **Code** provides a code only solution and will speed up the computation process in cases where a very high accuracy is not required.

Selecting **Float** will enforce that ambiguities are not resolved. Depending on the **Frequency** setting in the [Strategy](#) page you can process an L1 float, L2 float, L1+L2 float or an L3 float solution. Selecting an L3 float solution is useful when you process long baselines and have long observation times.

Note that if a baseline is longer than the value set under **Fix ambiguities up to** in the [Strategy](#) page, a float solution will be computed automatically.

GNSS type:

This parameter defines whether only **GPS** data shall be used or combined **GPS/GLONASS** or **GPS/Galileo** data. The default setting **Automatic** decides automatically depending on the data stored for reference and

rover.

This parameter can only be set, if GLONASS processing is included in your [licence](#).

Advanced Parameters:

On the bottom of the page you find a checkbox, by the help of which you can decide if you want to go for the specification of advanced processing parameters, or not. Ticking this check-box invokes two further tabs being shown to you for selection. These are:

[Strategy](#) and [Extended Output](#)

Active satellites:

A list box containing the numbers of all satellites from which measurements are available in the current project is displayed. G denotes GPS satellites, R denotes GLONASS satellites and E denotes Galileo satellites. Selected satellites are checked . Satellites can be manually disabled or enabled by clicking on the check box. Inactive satellites are disabled by default.

Note: The current satellite selection is valid for all selected tracks and also applies to SPP calculations. If satellites of individual tracks have to be deselected use [Satellite Windows](#).

GPS-processing Parameters: Strategy

Frequency:

This parameter defines the frequency, with which the data will be processed. LGO offers the following choices (with **L1** denoting GPS **and** GLONASS frequencies and **E1** denoting the Galileo frequency):

- **Automatic** (Default)
- **L1/E1**
- **L2**
- **L1/E1 + L2**
- **Iono free (L3)**

Automatic is the default setting. When chosen LGO will automatically select the best frequency or combination of frequencies for the final solution. If dual-frequency data is available both frequencies will typically be used. If the data additionally offers the L5 frequency then L5 will be included in the computation.

To better understand how LGO proceeds when **Automatic** is chosen [click here](#) and regard the theoretical background.

Because signal delay through the ionosphere is different for the L1/E1 and L2 frequency a linear combination of the two frequencies, which eliminates the influence of the ionosphere can be calculated. However, this so-called L3 solution also destroys the integer nature of the ambiguities. A float solution is computed instead while the ambiguities remain unfixed. For very long baselines (e.g. longer than 80 km) it is not critical to have a float solution (instead of ambiguities fixed). The L3 float solution is accurate enough according to the system specifications provided that the observation time is long enough.

If L1/E1 and L2 ambiguities can be resolved previously a second processing run can be started introducing the fixed L1/E1 and L2 integer ambiguities into the ionospheric-free linear combination. Ionospheric disturbances are eliminated while fixed ambiguities are used. This strategy is preferably used when ambiguities can be resolved but the ionospheric influence is significant (e.g. with baselines longer than 15 km).

With short baselines, though, using the ionospheric-free linear combination would increase the noise with little benefit. A standard L1/E1+L2 solution is best used then.

Selecting **Automatic** makes LGO use an L3 solution if dual-frequency data is available and the baseline is longer than 15 km. If ambiguities have been resolved previously these are introduced into the ionospheric-free solution. If ambiguities have not been resolved, the result will be an L3 float solution. If the baseline is shorter than 15 km L1/E1+L2 will be processed.

Selecting **L1/E1** or **L2** will force the system to use only this particular frequency for computing a solution.

Selecting **L1/E1 + L2** will force the computation to use both frequencies L1/E1 and L2 without a second iono-free processing run independent of the baseline length.

Selecting **Iono free (L3)** makes the system compute an L3 solution independent of the baseline length.

Fix ambiguities up to:

This value defines the maximum distance of a baseline for which the system should try to resolve ambiguities. The system default value is 80km. Although you can set the limitation to a higher value, you should take care when doing so. Certainly there is no point in setting the value unrealistically high. For baselines above the limit a float solution will be computed.

The frequency used for computation depends on the selected **Frequency** parameter. If **Automatic** has been selected an L3 solution will be computed for baselines longer than 15 km. For long baselines (with typically long observation times!) it is not critical to have an L3 float solution (instead of ambiguities fixed). The L3 float solution will be accurate enough according to the system specifications.

Min. duration for float solution (static):

This parameter defines the minimum time for which LGO allows the computation of a float solution for static intervals. For short observation times float solutions may not be accurate enough and a simple code solution may be preferable. The default setting of **300 sec.** makes LGO switch to a code-only solution in case the ambiguities cannot be resolved for observation periods which are shorter than 300 sec.

Sampling rate:

The user can specify how much of the recorded data to use in GPS processing. For example the observation rate set on the field system may have been 1 second. During post-processing of the data in the office using LGO, the user may only want to use every second or third observation for example. The available sampling rates are **0.1, 0.2, 0.5, 1, 2, 3, 4, 5, 6, 10, 12, 15, 20, 30** and **60** seconds. The **use all** option will use all recorded observations.

Tropospheric model:

The troposphere, that part of the atmosphere up to a height of about 30 kilometers causes a delay in the propagation of electromagnetic waves such as those used in GPS. To compute this delay the behavior of the refractive index for the troposphere must be known. Various models exist (all based on information of pressure, temperature and relative humidity of the ground station) which allow this path delay to be computed.

LGO offers the following choice of models:

- **Hopfield**
- **Simplified Hopfield**
- **Saastamoinen**
- **No troposphere**
- **Computed**

The differences that result from using different models are small (a few millimeters). It is recommended that the locally-used model is adopted for all computations in a particular country or area. If you are not familiar with any of these models use the system default **Hopfield**.

The model **No troposphere** does not apply any corrections and should not be used for practical purposes. It might however be interesting for investigation purposes.

Select **Computed** if you want to calculate variations of the tropospheric zenith delay between reference and rover from epoch to epoch. This may be advisable for longer baselines or for baselines with a larger height difference. In these cases tropospheric conditions are assumed to vary over the time or to be different on reference and rover. Selecting the option **Computed** will improve the height component of the processed baseline.

Ionospheric model:

The ionosphere is a tenuous atmosphere of electrically charged gas (plasma) that surrounds the Earth at altitudes between 100-1000 km. The ionosphere causes a signal path delay, which can sometimes amount to several tens of meters.

The **ionospheric model** parameter defines which model is used to reduce the impact of the ionosphere. This is of special importance if you try to resolve ambiguities.

The following models for the ionosphere are available:

- **Automatic** (Default)
- **Computed model**
- **Klobuchar model**
- **Standard**
- **No model**
- **Global / Regional model**

The system default is **Automatic**. LGO selects a model to be used according to the duration of the sessions without you having to interfere and decide on a specific model. For observation times on the reference longer than 45 min. your own ionospheric model may be computed, so that automatically the option **Computed model** will be taken, whereas with shorter observation periods the **Klobuchar model** will be preferred. If no almanac is available, though, **No model** will be used with observation times below 45 min.

If **Computed model** is selected and if the user has at least 45 minutes of static or rapid-static dual-frequency data collected at the reference station, LGO will compute an ionospheric model. This is advantageous, as the model computed is in accordance with conditions prevalent at the time and position of observation. If this model has been selected manually, but less than 45 minutes of data are available the processing parameters will automatically be switched to **No model**.

The **Klobuchar model** reflects the 11-year cycle of solar activity particularly well and can be advantageous during the time of high solar activity. The Klobuchar model should only be selected if observation data from Leica receivers is being used to process, since this kind of data contains the necessary almanac files. If the observation data has been imported via RINEX and the Klobuchar model is selected, the processing parameters automatically switch to **No model** because of the missing almanac.

The **Standard model** is a single layer model that is based upon assumptions on the total amount of electrons and their distribution within this layer. Based on this model the ionospheric path delay is computed at each epoch to each satellite.

Whether it is chosen automatically or manually, the choice of **No model** implies low ionospheric activity. With increasing ionospheric activity it might be better to select a different model. The ionospheric activity follows an eleven years cycle with its last peak in 2002.

In the IGS network global ionospheric models are computed on a daily basis and are available on anonymous FTP accounts free of charge. The University of Bern in Switzerland currently offers such files in Bernese format. LGO supports files in this Bernese format only.

The user may use a **Global / Regional model** if such an ionospheric file is available. If the user selects this option and there is no such file available, the option **No model** will be selected automatically.

To download the daily files from the University of Bern and use them in LGO [proceed as follows](#):

1. Use FTP, the address is **FTP.UNIBE.CH** (or 130.92.4.48)
2. User ID (name) is "anonymous". Use your email address as the password.
3. Change to the directory **aiub/CODE**
4. Change to the directory of the required year.
5. Select the file you require. The naming convention is as follows: CODwwwwd.ION.z
With 'www' being the GPS week and 'd' the day of the week (Sunday = 0, Monday = 1 etc)
6. Use WINZIP to extract the file CODwwwwd.ION.z.
7. When the download is complete, copy the file into the directory of your project. Do not change the file name.

Use stochastic modelling:

Select this option if you want to model the ionosphere additionally by calculating the ionospheric impact for each epoch. Stochastic modelling supports ambiguity resolution on medium and longer baselines when you suspect the ionosphere to be quite active. You should, however, be careful with short baselines since bad data –e.g. influenced by multipath or obstructions- may be misinterpreted as being influenced by ionospheric noise.

Thus, it is recommended to leave the default value for the **Min. distance** set to 8 km. With shorter baselines the ionospheric influence is smaller and stochastic modelling is not necessary.

It is advisable to leave the **ionospheric activity** option set to **Automatic**. LGO will then, depending on the baseline length, automatically set the level by which the changing of the ionospheric activity from epoch to epoch is modelled. You may set the **ionospheric activity** parameter manually to **Low**, **Medium** or **High**, if you have reliable indications on the current ionospheric activity.

Note: The option to **use stochastic modelling** is disabled:

- if Solution Type is set to Code
- if Solution Type is set to Float and Frequency is set to Iono-Free (L3).

GPS-processing Parameters: Extended Output

In this Property page you can select additional information to be calculated during the processing run. The parameters will then be available in the [Results View](#).

Note:

- You have to select the extended output parameters **before** you start the processing run. Only then will they be calculated and displayed in the GPS-Processing Analysis tool and in the GPS Processing reports.

DOP values, Azimuth/ Elevation:

If this option is checked LGO will compute DOP values for each observation as well as azimuth and elevation for each satellite and each observation. The various values can then be displayed graphically in the [GPS-Processing Analysis Tool](#). The minimum and maximum DOP values for GDOP, PDOP, HDOP and VDOP may also be displayed in the [Results View](#) and in the Processing reports.

Storage rate for DOPs/ Azimuth/ Elevation:

From the combo box select the rate at which *DOP values* and/ or *azimuth/ elevation* values are calculated. You can select a rate of **0.1, 0.2, 0.5, 1, 2, 3, 4, 5, 6, 10, 12, 15, 20, 30, 60** or **300** seconds. The storage rate is independent of the sampling rate defined in the [Strategy](#) page. Selecting **20% of data rate** will calculate the values for every 5th observation.

A storage rate for *DOP values* and/ or *azimuth/ elevation* can only be selected if you decided on these values to be calculated.

Residuals:

If this option is checked LGO will compute the Residuals for each epoch, satellite and observation type (code and phase; L1, L2, L3, L4 or L5). The Residuals can then be displayed graphically in the [GPS-Processing Analysis Tool](#).

Auto. Processing Parameters

The Auto. Processing Parameters only apply if the **Processing Mode** has been set to **Automatic**.

The Automated Processing mode will intelligently select the reference and rover stations and process all possible combinations of baselines that conform to the following parameters.

Min. time for common data:

This sets the minimum amount of time over which simultaneous measurements must be taken at two stations before LGO will try to process the baseline between those two stations. The default value is 300 seconds.

Max. baseline length:

Sets the maximum length of baselines up to which LGO will try to process.

Processing mode:

If **all baselines** is selected LGO will process all possible combinations of baselines that conform to the previous two parameters.

If **independent set** has been selected LGO will only process a set of independent baselines. Note that between **n** points which are measured at the same time only **n-1** independent baselines exist.

[Example:](#)

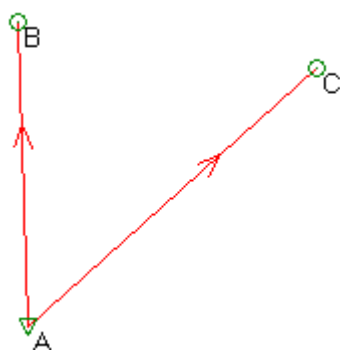
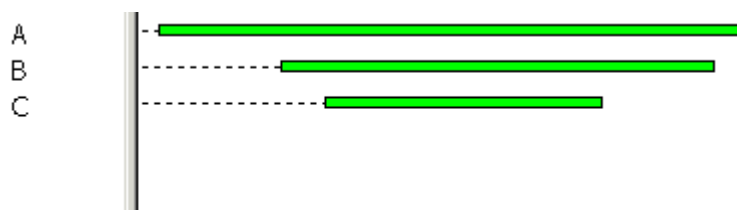

Baselines are also treated as independent if they are mathematically linear-dependent (e.g. 3 baselines building up a triangle), but not measured at the same time.

[Example:](#)

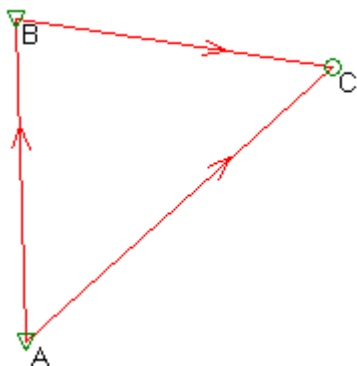

Coordinate seeding strategy:

Selecting **distance** means that the shortest baseline from the first reference point will be computed first. LGO then decides which is the next shortest baseline. This may be from the first point or from the point that was last computed. This line is processed next and then the process is repeated. Note that this is also dependent on the first two parameters set (see above).

Selecting **time** means that the baseline with the longest common observation time will be computed first. Similarly to the distance method, LGO then decides which point has the next longest common observation time and processes that line. The process continues like that. Note that this is also dependent on the first two parameters set (see above).

Session by session: If this option is checked , LGO computes all possible baselines from the reference that has been identified according to the selected seeding strategy before proceeding with the next reference. The point with the longest interval will be selected as the first reference.

Use float solutions as reference:

Allows points, for which only float solutions exist, to be used as reference points for further processing.

Re-compute already computed baselines:

If this option is checked baselines that have been calculated and stored previously will be re-calculated.

Compute baselines between control triplets:

If this option is checked baselines between points having **Control** triplets will also be processed. This may be interesting if the **Control** points are not kept absolutely fixed in a subsequent adjustment.

Modify GPS-processing Parameters

1. From the context menu (right-click) select Processing Parameters.
2. In the Property-Sheet use the tabs to switch between the following pages:

General
Auto. Processing

In the **General** page an option called 'Show advanced parameters' may be ticked, which then offers you access to two further pages:

Strategy
Extended Output

If the default setting is such that these two pages are visible anyhow, then they may be hidden by deselecting this option. Change the default data processing settings under **Tools – Options**.

3. Make your changes or press the **Default** button to apply the default values to the parameters of a page.
4. Press **OK** to confirm or **Cancel** to abort the function.

Note:

- If you intend to modify the default values itself, you may do so under [Tools - Options - Default Parameters](#).

Properties

Display Interval Properties (Track)

Enables you to display and edit the Interval Properties of a Track such as Antenna Properties and Annotations.

1. In the **GPS-Proc** Report View on the left-hand side right-click on an observation interval and select **Properties**.
2. Use the tabs to switch between the following pages:
 - Antenna
 - Annotation
3. Make your changes
 - Note:** Only the fields with white backgrounds may be edited at the particular instant.
4. Press **OK** to confirm or **Cancel** to abort the function.

Interval Properties (Point): Annotation

This Property-Page enables you to display/edit the Annotations of all Intervals for the selected Point.

Interval list box

If more than one Interval exists for a point, select an interval from the list.

Change the annotation 1-4 as required.

Note:

- Annotation 4 may contain the Seismic Record. For more information about Seismic Records please refer to the Technical Reference manual.
- All annotations for all intervals of a point can also be displayed in the [Points Report View](#).

Interval Properties (Point): Antenna

This Property-Page enables you to display/edit the Antenna Type and Height Reading of all Intervals of the selected Track.

Interval list box

If more than one Interval exists for the selected Point, select an interval from the list.

Antenna Type:

Displays the antenna type and allows you to change if necessary. All the antenna types used in the project are listed.

To create a new antenna type, press **View...** to open the Antenna Management property-page. In the local page the antennas associated with the project are displayed, while the global page show all antennas defined with the Antenna Management tool. To copy an antenna from global to local (project) use **Ctrl-C** and **Ctrl-V** from the keyboard or open the [Antenna Management](#) and drag an antenna definition to the Antenna View of the project.

Horizontal Offset:

This value depends on the antenna type selected. See also: [Antenna Management](#).

Vertical Offset:

This value depends on the antenna type selected. See also: [Antenna Management](#).

Height Reading:

The height reading that was measured and entered in the field.

Measurement Type:

The Height Reading can be measured **Vertical** or as a **Slope** distance. See also: [Antenna Height Reading](#).

Total vertical Height:

Vertical distance from the point on the ground to the mechanical reference plane on the antenna.

Interval Properties (Track): Annotation

This Property-Page enables you to display/edit the interval (point) annotation.

Interval list box:

If a track consists of more than one interval, select an interval from the list.

Change the annotation 1-4 as required.

Note:

- Annotation 4 may contain the Seismic Record. For more information about Seismic Records please refer to the Technical Reference manual.
- All annotations for all intervals of a point can also be displayed in the [Points Report View](#).

Interval Properties (Track): Antenna

This Property-Page enables you to display/edit the antenna type and reading of all intervals of a track.

Interval list box:

If a track consists of more than one interval, select an interval from the list.

Antenna Type:

Displays the antenna type and allows you to change if necessary. All the antenna types used in the project are listed.

To create a new antenna type, press **View...** to open the Antenna Management property-page. In the local page the antennas associated with the project are displayed, while the global page show all antennas defined with the Antenna Management tool. To copy an antenna from global to local (project) use **Ctrl-C** and **Ctrl-V** from the keyboard or open the [Antenna Management](#) and drag an antenna definition to the Antenna View of the project.

Horizontal Offset:

This value depends on the antenna type selected. See also: [Antenna Management](#).

Vertical Offset:

This value depends on the antenna type selected. See also: [Antenna Management](#).

Height Reading:

The height reading that was measured and entered in the field.

Measurement Type:

The Height Reading can be measured **Vertical** or as a **Slope** distance. See also: [Antenna Height Reading](#).

Total vertical Height:

Vertical distance from the point on the ground to the mechanical reference plane on the antenna.

Change antenna height for all moving parts (non-instantaneous points) of track

Change antenna height for all instantaneous points in track

Depending on the measuring mode the antenna height for the moving intervals may be different from the antenna height of the static intervals. I.e. if you are using a vehicle for the moving intervals and a pole for the static intervals you may want to change the height for either the moving intervals only or for the moving and the static intervals. Or you want to change the height of individual static intervals or all static intervals together.

For System500 data this applies to the Mixed Track (MXD) only.

For System 200/300 this applies to time tagged points in the case of KIS and KOF data and to the static intervals in the case of SGS data.

Note:

- Within the Office software you have the possibility to modify the antenna details type and height reading after the data has been assigned to a project.
- When changing the height reading of an observation interval on a reference the coordinates of the reference will remain unchanged, but all rover coordinates computed with respect to this reference observation will be shifted by dh. This shift also has its effect on the baseline properties.
- If the height reading of a rover observation is changed, then just that one measured triplet will be affected. This shift also has its effect on the properties of that particular baseline.
- If you change the antenna type, this will have no direct effect on the associated coordinates. When changing the antenna type re-processing of the baselines is recommended.

Point Properties (GPS-proc)

This Property-Sheet enables you to display and/or modify the point properties.

1. In the report-view on the left-hand side right-click on an observation interval and select **Edit Point...**

Use the tabs to switch between the following pages:

General

Stochastics

Thematical Data

Reliability (available only if the reliability has been previously calculated using the Adjustment component)

Mean (available only if more than one baseline for a particular point exists)

Hidden Point (Position) (available only if the selected point is a Hidden Point)

Hidden Point (Height) (available only if the Hidden Point has height properties attached)

2. Make your changes

Note: Only the fields with white background may be edited at the particular instant.

3. Press **OK** to confirm or **Cancel** to abort the function.

Graphical Settings

Graphical Settings (GPS-processing)

The Graphical Settings Property-Sheet consists of the pages **General** and **Styles and Colors**.

1. In the graphical view right-click in the background and select **Graphical Settings...**
2. In the Property-Sheet use the tabs to switch between the following pages:
 - General
 - Styles and Colors
3. Make your changes or press the **Default** button to apply the default values to the parameters of a page.
4. Press **OK** to confirm or **Cancel** to abort the function.

Graphical Settings: General (GPS-proc)

Grid Scale:

The Grid lines are the vertical lines in the graphical view that represent the time intervals. If **automatic** is checked a suitable grid scale will be chosen automatically by the system and the time marks in the heading will change accordingly.

To select a user-defined interval, deselect **automatic**, chose **Days, Hours, Minutes, or Seconds** and enter a time interval.

Text:

Using these check-boxes you can select to display additional information to the observation interval bars in the graphical view.

Show Point Id --- 5972 To show the point id of an interval

Show Duration ----- 10' 45" To show the duration of an interval

Clear background --- 5972 10' 45" To cut out the text from the background. Select this option if you have chosen a dark background color for the reference interval.

Tip: Displaying this information can be useful when printing.

Printing:

Select **Condensed** if you want to reduce the height of the graphical elements for printing.

Graphical Settings: Styles and Colors (GPS-proc)

Use this Property-Page to define the colors and line types for manual selection:

Reference:

Select the color for the **Reference** tracks from the list.

Background:

Select the color for the **Background of the Reference** tracks from the list.

Rover:

Select the color for the **Rover** tracks from the list.

Init:

Select the color for the **Initialization on known point** tracks from the list.

SPP:

Select the color for **Single Point Positioning** tracks from the list.

Real-time only:

Select the color for the **Real-time only** tracks from the list. These are the tracks for which no raw data is available.

Deselect:

Select the color for **Deselected** tracks from the list.

Track:

Select the color and the line type for the **Track lines** (horizontal lines) from the list.

Grid:

Select the color and the line type for the **Grid lines** (vertical lines) from the list.

TPS Processing

TPS-Processing

The **TPS-Proc** view enables you to display all **Setup Applications**, all **Traverses** and all **Sets of Angles Applications** within a project. The **Setups**, **Traverses** and **Sets of Angles** are displayed in a **user-configurable** report view.

- The TPS-Processing may be accessed via the  **TPS-Proc** Tab from within a project window.

The tree-view lists all  **Setups**,  **Traverses** and  **Sets of Angles** each indicated by its Station or Traverse ID and its Date/ Time.

Setup Applications:

When you click on the  **Setups** node in the tree-view all Setup Applications within the project will be listed in the corresponding report-view.

For each setup the folder in the tree-view contains the  **Setup Observations** and the  **Survey Observations**.

 The **Setup Observations** list all measurements included in the definition of the Setup application. Such observations contributed to setting the orientation and, depending on the setup method, to setting the station coordinates.

 The **Survey Observations** contain all sideshots taken with the orientation of the selected setup.

Setups may be **deleted without** deleting the included observations.



Via the TPS-Proc view you may access the **Properties** of the TPS Setups and Observations. From within the **Setup Properties** dialog you can **Recalculate** setup applications. You can also re-calculate all setups which are stored with the 'Allow automatic update' flag using the **Update Setups** command.



In addition you can change the setup coordinates for **Smart Station** setups using the **Exchange Coordinate System** command if the existing coordinates have been derived with a preliminary coordinate system.

To get an overview on the setup data in a printable report, including information like the method that was used, the observations and target coordinates used in the calculation and/or the calculation results invoke the **Setup Report**.

Traverses:

Traverses consist of **Setups** and may either be imported from the SmartWorx Traverse Application or be **created manually** from Setup Applications stored in the **TPS-Proc** view.

When you click on the  **Traverses** node in the tree-view all Traverses within the project will be listed in the corresponding report-view. When you click on a single  **Traverse** in the tree-view the **Traverse Booking Sheet** and a graphical representation of the selected traverse will be displayed in the right-hand side **Traverse View**.

For each traverse the folder in the tree-view contains the  **Traverse Observations** and the  **Survey Observations**.

 The **Traverse Observations** include all the measurements on a Setup in the traverse to its backsight setup and its foresight setup.

 The **Survey Observations** contain all sideshots taken from a setup in the traverse. If Check Points have been measured for the selected traverse the measurements to those check points will be included in the respective Survey Observations node.

Traverses may be **deleted** without deleting the included setups.

Via the TPS-Proc view you may access the **Properties** of a Traverse. From within the **Traverse Properties** dialog you can **Recalculate** a traverse.

The **Processing Parameters** may be set individually and the computation results may be viewed in a **Traverse Report**, which may be printed or saved as an HTML file.





In addition you can change the setup coordinates in a traverse for **Smart Station** setups using the **Exchange Coordinate System** command if the existing coordinates have been derived with a preliminary coordinate system.

A summary of the different ways in which a traverse may be measured is given in the overview topic: **Traversing techniques**.

Sets of Angles Applications:

When you click on the  **Sets of Angles** node in the tree-view all Sets of Angles Applications within the project will be listed in the corresponding report-view.

For each Sets of Angles the folder in the tree-view contains the included  **Observations** and the  **Results**.

-  The **Observations** list all measurements included in the definition of the Sets of Angles calculation. For each target point and set observations may be included in both faces.
-  Under **Results** the reduced observations for each target point are listed in the report view on the right-hand side. Additionally, the  **Sets of Angles Report** may be invoked for each  **Sets** from the **Results** tree.

Sets of Angles applications may be **deleted without** deleting the included observations.

Via the TPS-Proc view you may access the **Properties** of the Sets of Angles applications. From within the **Sets of Angles Properties** dialog you can **view the results** for each target point, **activate** or **de-activate** entire sets or target points (in all sets) and **recalculate** the application.

The tolerances for residuals and face differences can be set in the **Sets of Angles Tolerances** dialog.

To get an overview on the Sets of Angles calculation in a printable report, including information on the instrument that has been used in the field, on the mean errors calculated for the sets of angles and on the point results, the residuals and face differences invoke and see the **Sets of Angles Report**.

See also:

[Create a Setup Application](#)

[Exchange Coordinate System](#)

[Allow automatic update](#)

[Update Setups](#)

[Setup Report](#)

[Setup Properties](#)

[TPS Observation Properties](#)

[New Traverse](#)

[Delete a Traverse](#)

Traverse View

Traverse Report

Traverse-processing Parameters

Traverse Properties

Create a Sets of Angles Application

Sets of Angles Tolerances

Sets of Angles Properties

Sets of Angles Report

Calculate geometrical PPM

With each TPS Observation the geometrical PPM factor is stored and used to calculate the horizontal distance and the coordinates of the target points. Modifying the geometrical PPM does not change the original slope distance measurement.

You can display and modify the geometrical PPM of a TPS observation in the [Observations View](#) or in the **Survey Observations** report view of the [TPS-Processing](#) tabbed view.

To modify the geometrical PPM:

- Highlight one or more TPS observations and select **Edit geometrical PPM...** from the context menu.

In the **Calculate geometrical PPM** dialog you may decide to **manually** calculate the PPM factor from the projection scale factor, the height scale factor and an individual scale factor. If a coordinate system is attached to the project, you may alternatively decide to **automatically** calculate the geometrical PPM from the parameters defining the coordinate system and from the station heights.

Manual calculation:

If you select **Manual** in the **Calculate Scale** combo-box, you may enter the following parameters:

- Scale at Central Meridian
- Offset to the Central Meridian
- Height above Reference Ellipsoid
- Individual PPM

The Map Projection Scale Factor (**Map Proj. PPM**), the Height Scale Factor (**PPM above Ref.**) and the total geometrical PPM factor are then calculated from the input parameters.

Automatic calculation:

If you select **Automatic** in the **Calculate Scale** combo-box, the Map Projection Scale Factor (**Map Proj. PPM**) is calculated automatically for each selected TPS observation using the coordinate system attached to the project and the local grid coordinates of the station coordinates. The Height Scale Factor (**PPM above Ref.**) is calculated using the height of the setup point.

If more than one observation was selected, the calculated scale factors can be displayed by scrolling through the observations listed on the page.

Note:

- Modifying the **geometrical PPM** is not allowed if the observation is used in a **Resection** or **Multiple Backsights** setup application.

Calculate atmospherical PPM

With each SmartWorx TPS observation the atmospherical PPM factor is stored, which was used on the instrument to calculate the slope distance. Modifying the atmospherical PPM will change the original slope distance measurement. As a consequence the measured coordinates of the target point will be modified.

You can display and modify the atmospherical PPM of a TPS observation in the [Observations View](#) or in the **Survey Observations** or **Setup Observations** report view of the [TPS-Processing](#) tabbed view.

To modify the atmospherical PPM:

- Highlight one or more TPS observations and select **Edit atmospherical PPM...** from the context menu.

In the **Calculate atmospherical PPM** dialog you may decide to either calculate the PPM factor from the measured meteorological data (temperature, pressure, humidity) or to enter the scale factor manually.

- Modify the values for **Temperature**, **Atmospheric Pressure** and **Relative Humidity** in the **Setting** column via in-line editing. The **Units** may be switched via in-line editing, too. The entered **Setting** value is adapted automatically.

Note: Instead of the Atmospheric Pressure you may enter the **Elev. above MSL** and instead of the Relative Humidity you may enter the **Temp. Wet-Bulb**. Switch the options via in-line editing.

Note:

- When modifying the atmospherical PPM of a **setup** or **traverse** observation it is recommended to re-calculate the setup or traverse.

Exchange Coordinate System (Smart Station)

This command enables you to recalculate the station coordinates of a TPS setup or the coordinates of a set of points if the coordinate system used to derive the coordinates changes.

To exchange a coordinate system becomes necessary if your setup coordinates have been derived using a Smart Station instrument and only a preliminary coordinate system was available in the field.

To invoke the functionality:

- For a single TPS setup invoke the functionality from the [Setup Properties: General](#) page by pressing the  button in the lower left corner of the dialog.
- To exchange the coordinate system for one or for more than one setup select the setup(s) in the **TPS-Proc** report view and select **Exchange Coordinate System...** from the context menu or from the TPS-Proc main menu.
- You can also select a series of points in the **View/ Edit** or in the **Points** tabbed view and select **Exchange Coordinate system...** from the background context menu or from the main menu.

The **Exchange Coordinate System Wizard** starts.

Start:

In the **Start** page of the wizard you are presented with a list of all point triplets which will be recomputed. The points are given together with their local grid coordinates in a configurable report view.

- If you have selected a TPS setup in the **TPS-Proc** view, then the Reference triplet of the station setup and all connected measured point triplets will automatically be included in the list.
- If you have selected a series of points in **View/ Edit** or in the **Points** view, then the list of points is based upon the selection. It is influenced, though, by some conditions which add or remove points to or from the list as follows:
 - Only points stored with **Local Grid** coordinates are displayed. Point triplets which are **not** stored as Local Grid (but e.g. as WGS84) cannot and will not be transformed.
 - The points must have position information. **Height-only** point triplets will be **ignored**.
 - Only Point classes **Estimated**, **Measured**, **Reference**, **Adjusted** and **Control** will be listed.
 - Measured point triplets, **to which** an **observation** has been made, will be **removed** from the list, **if** the reference point (the TPS setup point) from which the observation has been made is **not included** in the selection **either**.
 - If you have selected a **Reference** point triplet, then **all** connected measured point triplets will automatically be included in the list.

By this selection mechanism it is ensured that setup and target points are always **transformed together**. Inconsistencies are avoided.

Coordinate System selection:

In the **Coordinate System selection** page of the wizard:

- Determine the **old** and the **new** coordinate system. All coordinate systems stored in the [Coordinate System Management](#) (except WGS1984 and None) are offered for selection.

- Decide if you want to **Keep the heights** of the preliminary system and transform only the position to the new coordinate system.
- Decide if you wish to **Attach the new coordinate system to the project**. This is recommended to ensure that any GPS measured points fit to the newly transformed TPS points.

Finish:

In the **Finish** page of the wizard the new local grid coordinates are listed for all point triplets. They are derived by transforming the original grid coordinates to **WGS84** using the **old coordinate system** and re-transforming the coordinates back to local grid using the **new coordinate system**.

- Click **Finish** to update all points in the database. The existing local grid coordinates will be replaced with the coordinates as displayed in this page.
- Click **Back** if you want to modify the coordinate systems.
- Click **Cancel** to abort the operation without any changes to your project coordinates.



Note:

- Since the backsight coordinates change together with the station coordinates for all setups of method **Set Orientation** or **Known Backsight** the orientation of the setup is updated after executing the **Exchange Coordinate System** command.

Setups

Create a Setup Application

Setups **measured** with the SmartWorx **Setup Application** will automatically be listed as  **Setups** in the **TPS-Proc** view. They contain information on the **Setup method** and the observation type (**Setup observations** are clearly differentiated from **Survey Observations**).

However, setups that have been imported from a GSI or TDS file or that have been manually **created** in the  **View/ Edit** or the  **Adjustment** component lack information on the **Setup method** and the **Observation type**.

Thus, to recognize such setups as **Setup Applications** and have them displayed as  **Setups** in the  **TPS-Proc** view they have to be manually defined via the **New Setup application...** functionality.

To create a Setup Application:

1. In the  **TPS-Proc** view right-click on  **Setups** in the tree view and select **New Setup application...** from the context menu.

Alternatively, right-click in the **Setups** report view and select **New Setup application...** from the context menu.



The **New Setup Wizard** starts up.

2. In the **Start** page of the wizard select the TPS *Reference* point from which the Setup observations that shall make up the new Setup Application have been measured. Click **Next**.
3. In the **Select Setup** page select one of the Setups that have been measured or manually created on this *Reference* point.

Note: Only those Setups will be offered for selection that have not been used already for creating a Setup Application, i.e. a Setup can only be used once for creating a Setup Application.

Click **Next**.

4. In the **Select Setup Observations** page select the **Setup Method** that shall be used for calculating the new Setup. In the left-hand side report view select (an) observation(s) from the currently selected TPS *Reference* point to one or more target points.

In the left-hand report view (multi-)select the required target points and press the  button to add the observation(s) to the right-hand side graphical view. To remove an observation again from the graphical view, select it in the graphical view and press the  button.

Alternatively, right-click on the observation in the graphical view and select **Remove** from the context menu.

Note: If a method allows for just one observation (Set Orientation or Known Backsight) to be selected, multi-select is not possible and the observation added to the graphical view will instantly be removed again at the moment another observation is added to the graphical view. For 'Resection' and 'Multiple Backsights' methods at least two observations must be added to the calculation.

5. Click the **Finish** button to calculate the Setup. All observations added to the graphical view will be used in the calculation. Multiple observations to the same point will be averaged for the calculation. The current coordinates of the backsight point(s) will be used to calculate backsight azimuth, orientation and/or the Reference coordinates of the setup.

The newly calculated Setup will be stored and added to the list of  **Setups** in the **TPS-Proc** view. It may be flagged now to **Allow automatic update** and it may take part in the **Update Setups** process.

To get an overview on the setup data, like the method that was used, the observations and target coordinates used in the calculation and/or the calculation results invoke the [Setup Report](#).

Note:

- For the setup method *Resection Helmert* only observations with distance measurements are offered for selection.
If the current triplet of the backsight is a position-only point, then the observation will only be offered for *Resection* and *Multiple Backsights* setups and only if a distance measurement is included.
- Even if the Setup calculation fails the Setup will be added to the list of Setups in the TPS-Proc view. But its Orientation and the coordinates of the TPS *Reference* point remain the same as the input values, i.e. Orientation and coordinates are not re-computed.

Tip:

- To view/ edit the [Observation Properties](#) right-click on an observation either in the left-hand report view or in the graphical view and select **Properties...** from the context menu.

To view the [Point Properties](#) right-click on a point in the graphical view and select **Properties...** from the context menu.
- To zoom in and out of the graphical view right-click and select **Zoom In/ Out** from the background menu.
- [Panning](#) may be switched on from the background menu to be able to comfortably navigate within the graphical view.
- To modify the settings for the graphical view right-click and select [Graphical Settings...](#) from the background menu. If a background image is attached to the project it may be switched on in the graphical view via the **Graphical Settings....**

Delete a Setup Application



Enables you to delete a **Setup Application** in the  **TPS-Proc** component.

1. In the Setups report view highlight a **Setup** and select **Delete** from the context menu.
2. Press **Yes** to confirm or **No** to exit without deleting.

Note:

- The **observations** included in the Setup to be deleted **will be kept**.

Edit a Setup Application

Existing Setups listed under  **Setups** in the  **TPS-Proc** view may be edited to change the **Setup Method** or to add/ remove observations to/ from the Setup calculation.

To edit a Setup Application:

1. In the **TPS-Proc** view right-click on a **Setup** and select **Edit Setup...** from the context menu.
2. In the **Edit Setup** dialog add/ remove observations to/ from the Setup as required and change the selected **Setup Method** if necessary.
3. Leave the dialog with **OK** to apply the changes. The Setup will be re-calculated.

To get an overview on the setup data, like the method that was used, the observations and target coordinates used in the calculation and/or the calculation results invoke the **Setup Report**.

See also:

[Setup Properties: General](#)

[Setup Properties: Observations \(Set Orientation, Known Backsight\)](#)

[Setup Properties: Observations \(Resection, Multiple Backsights, Height Transfer\)](#)

[Create a Setup Application](#)

Tip:

- To view/ edit the **Observation Properties** right-click on an observation either in the left-hand report view or in the graphical view and select **Properties...** from the context menu.
To view the **Point Properties** right-click on a point in the graphical view and select **Properties...** from the context menu.
- To zoom in and out of the graphical view right-click and select **Zoom In/ Out** from the background menu.
- **Panning** may be switched on from the background menu to be able to comfortably navigate within the graphical view.
- To modify the settings for the graphical view right-click and select **Graphical Settings...** from the background menu. If a background image is attached to the project it may be switched on in the graphical view via the **Graphical Settings...**

Allow automatic update

If in the **Setup Properties: Observations** page for **Set Orientation** and **Known Backsight** setup applications or for **Resection** and **Multiple Backsights** setup applications the flag called **Allow automatic update** is active, then the respective setup is included into the automatic **Update Setups** process. The status may be changed to include or exclude a setup in or from the automatic recalculation of multiple setups.

To change the 'Allow automatic update' status:

1. Click on the  **Setups** node in the **TPS-proc** tree view.
2. In the corresponding report view (multi-) select the Setup(s) for which you want to activate or de-activate the flag.
3. Right-click into the selection and select **Allow automatic update** from the context menu. The status will be changed for all selected setups.

You may check the current status in the **Allow autom. update** column.

Note:

- For single setups the **Allow automatic update** status may also be changed in the respective **Setup Properties: Observations** page.

Update Setups

This command enables you to recalculate multiple setups when new coordinates are available for your backsight points.

To invoke the operation:

- Select **Update setups** from the background menu of the **TPS-Proc** view or from the **TPS-Proc** main menu.

When you execute this command the office software will loop over all TPS setups stored in the **TPS-Proc** view and will recalculate all setups which have the **Allow automatic update** checkbox ticked in the **Setup Properties: Observations** page. The operation makes use of the grid coordinates (current point class) of the backsight points to recalculate the orientation and to, subsequently, update all measured points connected to each setup. All types of setups including 'Resection' methods and 'Multiple Backsights' may be included in the automatic update.

Depending on the complexity of the project it may be necessary to inspect the current coordinates of the backsight points before.

Note:

- After importing the data the **Allow automatic update** box is checked for all setups which had the 'Update later' option set on the instrument. However, it is possible to modify the setting later so that setups may be included or excluded manually from the automated update.
- You may include or exclude multiple setups from the automatic update mechanism by selecting **Allow automatic update** from the context menu of the **Setups** report view in the **TPS-Proc** tabbed view.
- Every setup will only be recalculated once when executing the Update setups command. The update is performed in chronological order starting with the oldest setup.
- For setups of method 'Height Transfer' automatic update is not supported.

See also:



[Allow automatic update](#)

[Setup Properties: Observations \(Set Orientation, Known Backsight\)](#)

[Setup Properties: Observations \(Resection, Multiple Backsights\)](#)

Setup Report

To get an overview on one or more Setups in your project you may invoke the **Setup Report**.

- In the **TPS-proc** tree view right-click on a  Setup in the  **Setups** node and select **Setup Report** from the context menu.

Alternatively: Right-click on a Setup in the **Setups** report view and select **Setup Report** from the context menu.

Note: To get a report on several Setups at a time multi-select the Setups to be included in the report in the **Setups** report view, right-click into the selection and select **Setup Report** from the context menu.

The report opens in a stand-alone window and is listed in the **Open Documents** list bar.

Stand-alone reports can be saved as HTML files or printed:

- To save a report as an HTML file right-click inside the report and select **Save As...**
- To print a report right-click inside the report and select **Print**. A **Print Preview** is also available from the context menu.
- To select the **contents** and the **format** of the report right-click and select **Properties...** from the context menu or click  in the **Reports** toolbar. For further details refer to: [Configure a Report](#).

When the report has been configured to display all possible sections it presents you with the following information:

- Project Information**
- Instrument Information**
- Setup Method**
- Setup Observations**
- Target Coordinates**
- Fixpoints**
- Target Residuals**
- Setup Results**
- Station Coordinate Comparison**

Project Information

[Example:](#)

Project Information

Project name: P_TPS
 Date created: 24-01-07 12:38:39
 Manager: Mr. Johnson
 Client: Little Hut Company
 Street: Woods Lane
 Coordinate system name: utm32n
 Application software: LEICA Geo Office 5.1

This section gives you general information on the [Project Properties](#), like the project name, creation date and time and the attached coordinate system.

If information has been entered in the [Dictionary](#) page of the **Project Properties** dialog these pieces of information will be added to this section of the report.

Instrument Information

[Example:](#)

Instrument Information

Instrument Type: TCRP120X
 Instrument Serial Number: 212862
 Instrument Height: 1.69000 m
 Setup Time: 05/27/2005 10:54:21
 Geom.ppm (min-max): 442.5 - 442.5
 Atm.ppm (min-max): 12.4 - 16.3

This section gives you information on the instrument that was used in the field to measure the setup. The instrument type and serial number are listed, together with the instrument height and the time when the setup was measured. In addition information on the range of Geometrical and Atmospheric ppm values is given, summarized for all Setup observations.

Setup Method

This section lists the [Setup Method](#) that was used for calculating the setup for which the report has been invoked.

Setup Observations

[Example:](#)

Setup Observations

Point ID	Hz	V	Sl.Dist	H.Dist	Refl.Hgt	Refl.Type
R-01	343.5699 gon	100.1018 gon	46.4206 m	46.3998 m	1.8500 m	Leica 360° Prism
R-02	247.6853 gon	99.8482 gon	27.3114 m	27.2991 m	1.8500 m	Leica 360° Prism
R-03	42.3712 gon	98.9580 gon	32.6344 m	32.6155 m	1.8500 m	Leica 360° Prism

In this section the **Setup Observations** that were measured and used for the calculation of the setup are listed.

Target Coordinates

In this section the measured coordinates of the points to which the Setup Observations were made (of the **Target** points) are listed.

Fixpoints

For the methods *Resection*, *Resection Helmert*, *Multiple Backsights* and *Known Backsight* a sub-section with the Control coordinates of the **Fixpoints** that were used in the calculation will be added.

Target Residuals

[Example:](#)

Target Residuals						
Point ID	dHz	dDist	dE	dN	dH	Use
R-01	-0.0049 gon	-0.0013 m	0.0038 m	-0.0005 m	0.0020 m	3D
R-02	0.0080 gon	-0.0009 m	-0.0025 m	-0.0025 m	-0.0020 m	3D
R-03	0.0043 gon	0.0025 m	-0.0013 m	0.0031 m	-	2D

In this section the differences between the *measured* Target Coordinates and the *Fixpoints* are listed as the resulting **Target Residuals**.

Setup Results

[Example:](#)

Setup Results			
Station ID:	ST_03		
Easting:	546583.1795 m	Sd. E:	0.0028 m
Northing:	5250746.8021 m	Sd. N:	0.0028 m
Height:	450.9168 m	Sd. Hgt:	0.0020 m
Use scale:	Yes		
Calculated scale:	-230.3		
Orientation:	286.0345 gon		
Apply scale to survey obs:	No		

At the end the **Results** of the Setup calculation are listed, i.e. the station coordinates, the used and calculated scale factor, the calculated orientation and whether the scale factor is to be applied to the **Survey Observations** made on this setup.

Station Coordinate Comparison

[Example:](#)

Station Coordinate Comparison

	Point ID	Easting	Northing	Ortho.Hgt
CTRL:	ST_03	546583.1800 m	5250746.8000 m	450.9100 m
REF:	ST_03	546583.1795 m	5250746.8021 m	450.9168 m
Delta:	ST_03	0.0005 m	-0.0021 m	-0.0068 m

If, except from the calculated station coordinates (calculated from the Setup Observations), the point on which the setup is calculated (the station) has a *Control* triplet, too, then a **Coordinate Comparison** between the *Reference* and the *Control* triplet will be calculated and the results are listed in this section of the report.

Note:

- If the report is invoked for more than one setup then the single setups are reported on in the same order as they are listed in the **Setups** report view.

TPS Processing Guide

Whenever new coordinates become available for stations, on which a TPS setup exists, it may be required to update the reference coordinates assigned to the TPS setup as well as the orientation of the setup.

For the following operations such a case is automatically detected and you are suggested to perform these operations automatically:

- When a **traverse** was re-calculated and stored, all sideshots of the traverse are automatically updated. In this case it is checked whether on any of the sideshots a TPS setup exists and you are suggested to update this setup.
- When a GPS baseline is **stored** in the **Results Manager**, it is also checked whether a TPS setup exists for the rover point and you are suggested to update this setup. This will typically happen when post-processing *SmartStation* setups.

Whenever such a case is detected, the **TPS Processing Guide** dialog is displayed. This dialog lists all TPS setups, for which new coordinates have been stored in a report view. Activate all setups for which you want to perform the update and press **OK**. Alternatively press **Cancel** to abort the function.

The following operations will be done:

- The *Reference* triplet will be **updated** with the highest triplet (apart from the existing *Reference* triplet) available for the point after the previous store operation. This will automatically shift all connected TPS target points or GPS rover points.
- Afterwards the orientation of the setup will be re-calculated using the new setup coordinates. Changes in the orientation will also be applied to all connected TPS target points.

See also:

[Update Reference Triplet](#)

[Setup Properties](#)

Setup Properties

Setup Properties

This Property-Sheet enables you to display and/or modify the TPS **Setup properties** stored in the **TPS-proc** view.

1. Right-click on a setup in the tree-view or in the corresponding report view and select **Properties...** from the context menu.

Depending on the method the selected setup has been measured with one of the two different **Observations** pages will be displayed in addition to the **General** Setup properties:

General

Observations (Set Orientation, Known Backsight)

Observations (Resection, Multiple Backsights, Height Transfer)

Images (only available if at least one image is linked to the selected setup)

2. Make your changes.

In the **Observations** page you can **recalculate** the setup. Changes of the setup coordinates or orientation will be applied to recalculate all connected Survey Observations.

Press **OK** to confirm or **Cancel** to abort the function.

Setup Properties: General

This property page enables you to display or edit general information of SmartWorx TPS setups.

Date/ Time:

Displays the **Date/Time** the setup was created.

Method:

Displays the **method** the selected setup was measured with. The method cannot be changed for a selected setup. The following methods are possible:

Set Orientation:	Instrument was set up on a known point and oriented to a known azimuth.
Known Backsight:	Instrument was set up on a known point and oriented to a known backsight point.
Multiple Backsights:	Instrument was set up on a known point. The Orientation and/ or height were calculated by measuring to known target points.
Height Transfer:	Instrument was set up on a known point. The height was calculated by measuring to known target points.
Resection/ Resection Helmert:	Instrument was set up on an unknown point. Station coordinates and the orientation were calculated by measuring to known target points.
Orientate to Line:	Station coordinates and Orientation were derived from measuring to two points which define a local coordinate system.



Point Id:

Displays the **Point Id** of the selected setup. You may deactivate the setup by clearing the **Active** check box. This will exclude the setup and any associated observations from the adjustment computation.

Easting, Northing, Height:

Displays the **reference coordinates** and the associated standard deviations for the selected setup in local grid.

If necessary the point coordinates may be changed. Subsequently, all target coordinates connected to the setup will be shifted by the same amount.

Note: You can use the buttons in the lower left corner of the page to  **Copy** or  **Paste** the complete coordinate triplet to or from the clipboard.

Use the  button to **exchange the coordinate system** from which your setup coordinates have been derived. This functionality is available for setup coordinates that have been derived on a **Smart Station** instrument with a preliminary coordinate system.

Instrument Height:

Displays the **instrument height** on the selected setup. If necessary the instrument height may be changed.

If the instrument height was used in the field to calculate the height of the target points (**Set Orientation**, **Known Backsight**), then a change in the instrument height will automatically modify the heights of all connected target points by the same amount.

For the **Resection** methods and the methods **Multiple Backsights** and **Height Transfer** a change in the

instrument height only modifies the height of the setup, but not the heights of the connected target points, unless the height of the setup was excluded from the setup calculation.

Instrument type/ SN:

Displays the type of instrument used on the selected setup and its serial number.

Centring Error:

The **Centring error** defines the predicted error that could have been made when centring the instrument over the point. If necessary the centring error may be changed.

Height Error:

The **Height error** defines the predicted error when measuring the instrument height. If necessary the height error may be changed.

Tip:

- To get an overview on the setup data in a printable report, including information like the method that was used, the observations and target coordinates used in the calculation and/or the calculation results invoke the [Setup Report](#).

Setup Properties: Observations (Resection, Multiple Backsights, Height Transfer)

For the 'Resection' methods and the methods 'Multiple Backsights' and 'Height Transfer' the **Observations** page displays the following information:

Point Id:

Displays the Point Id of the selected setup.

Report view:

Displays all observations used within the setup application together with the target point coordinates and the residuals of the calculation.

Note: The coordinates displayed are the **current** point coordinates of the target points.

The following items can be modified by selecting **Modify** from the context menu:

- **Point Id:** Select an existing Point Id. The grid coordinates of the current point triplet will be filled into the **Coordinates** columns.
- **Use:** Select 'Use' if the observation shall be used for the position and/ or height calculation. Choose between **3D**, **2D**, **1D** and **No**.
- **Easting, Northing, Ortho. Height:** Modify the grid coordinates of the target points if required. The modified coordinates will be used for the calculation, but will not be stored in the project.
- **Target Height:** Change the target height if required. This will not affect the target coordinates.
- **Reflector Type:** Modify the reflector type if required. Changes in the additional constant will be applied to the measured slope distances. The coordinates of the target points will not be changed.

Computed Coordinates:

Displays the current coordinates and standard deviations for the selected setup. The computed coordinates will be updated when you press the **Recalculate** button.

Computed Orientation/Scale:

Displays the current orientation and scale of the selected setup. The computed orientation and scale will be updated when you press the **Recalculate** button.

Allow automatic update:

This setting can be used to automatically recalculate multiple setups. The status may be changed to include or exclude a setup in or from the automatic **Update Setups** process.

Recalculation of setups:

To recalculate the coordinates and/ or the orientation proceed as follows:

1. Modify any of the observations used in the setup application.
2. From the **Compute** combo-box in the upper right corner select which elements of the setup shall be recalculated.

For **Resection/ Resection Helmert** choose between:

- Easting, Northing, Height and Orientation
- Easting, Northing and Height
- Easting, Northing and Orientation

For **Multiple Backsights** choose between:

- Height and Orientation
- Height
- Orientation

The elements not computed remain as stored.

3. From the **Scale** combo-box select, whether you want to calculate a scale factor for your distances (**Yes**) or whether you want to keep the scale factor which was used in the field (**No**).
4. From the **Method** combo-box select, whether you want to calculate using **Least squares** or **Robust** techniques. The difference between the two methods is the weighting that gets applied to the observations. With the Robust method the weights are calculated from the fit between the observed and the computed values. This allows for good results even in case that errors are in the data, provided that sufficient target points have been observed.

For setups of type *Resection Helmert* you can select from the **Height** combo-box how the heights derived from the setup observations shall be weighted. You can choose between $1/d$ and $1/d^2$.

5. Press the **Recalculate** button. The computed coordinates and/ or the computed orientation will be updated. The residuals of the computation are displayed in the corresponding columns of the report view.
6. If you selected to calculate the **Scale**, the resulting value will be displayed as well. Check **Apply to survey observations**, if you wish to use the calculated scale factor as a geometrical ppm for all connected survey observations.
7. Leave the property page with **OK**. All connected measured point triplets calculated from the modified setup will be updated according to the new station coordinates and new orientation.

Note:

- If you recalculate a setup of method 'Orientate to Line', it will be processed as a standard Resection.
- For setups of the method 'Height Transfer' only the station height will be recalculated. Station coordinates, orientation and scale will be kept and are not available for selection. Automatic update is not supported.

Setup Properties: Observations (Set Orientation, Known Backsight)

For the methods 'Set Orientation' and 'Known Backsight', the **Observations** page displays the following information:

Point Id:

Displays the Point Id of the selected setup.

Backsight Point Id:

Lists the backsight Point Id used in the setup application together with its grid coordinates.

Note: The coordinates displayed are the **current** point coordinates of the backsight point. In case of method 'Set Orientation' the coordinates may not be available, if no distance was measured.

TPS observations:

The TPS Observations (**Direction**, **Distance** and **Zenith Angle**) are displayed and cannot be changed.

Azimuth:

Displays the azimuth to the backsight Point Id used for setting the orientation. This value can only be modified for setups of method 'Set Orientation'. When recalculating the orientation by selecting a different backsight point, the **Orientation** will be updated when pressing **Re-calculate**.

Allow automatic update:

This setting is activated, if 'Update later' was set in the field for backsight points for which new coordinates will be available later. In the Office the flag is used to automatically recalculate multiple setups. The status may be changed to include or exclude a setup in or from the automatic **Update Setups** process.

Orientation:

Displays the current orientation of the selected setup.

Recalculation of setups:

To recalculate the orientation of your setup, you have the following possibilities:

- Modify the grid coordinates of your backsight point. Press the **Recalculate** button to compute the new azimuth and the new orientation. Leave the property page with **OK** to update all measured point coordinates connected to the setup.
- Select a new backsight Point Id from the drop-down list. The grid coordinates of the current point triplet for the selected point will be loaded. Press the **Recalculate** button to compute the new azimuth and the new orientation. Leave the property page with **OK** to update all measured point coordinates connected to the setup.
- For setups of method 'Set Orientation' you can additionally directly change the azimuth value. Note, that you only can either enter a new azimuth **or** modify the backsight point. Press the **Recalculate** button to update the orientation. Leave the property page with **OK** to update all measured point coordinates connected to the setup.

Point, Line/Area, Setup Properties: Images

In this Property-Page all images linked to the selected **Point** or **Line/Area** or **TPS Setup** are given in an embedded thumbnail view together with the filename of each image and the date and time when the picture has been taken.

Note:

- This Property-Page is only available if there are images linked to the selected object.

If more than one image is linked to the selected object you may adjust the size of the thumbnails in the embedded view to be able to see more than one thumbnail at a time.

When you select an image a context menu is available from which you may choose to Open the image in the Windows default viewer or to Open the containing folder.

The Delete and Unlink functionality is available for a selection of one or more images.

Traverses

New Traverse

This functionality enables you to create a new traverse from existing **TPS Setups** stored in the **TPS-Proc** view.

- To create a new traverse right-click on the  **Traverses** node in the tree-view and select **New Traverse...** from the context-menu.

In the **New Traverse** dialog:

1. Enter a **Traverse Id**.
2. Select a setup from the right-hand view and press  to add the setup to the traverse which will subsequently be built up in the left hand view. After a setup has been included in the traverse (left-hand view) the right-hand view is updated to list only those setups, which have a **Setup Observation** to the currently last Setup Point in the traverse.

Note: If the first setup contains more than one **Setup Observation** (e.g. in case of a **Resection** setup), select the observation that shall be used as the initial **Backsight Point Id**.

3. For the last setup select the **Foresight Point Id** from the list of observations. This observation will be used as the final foresight in the traverse.
4. Press **OK** to store the traverse.

Note:

- Each setup can only be included in one traverse. Setups which are already included in a traverse will not be available for selection in the right-hand view any more.
- You can remove a setup from the traverse before finally storing the traverse by right-clicking onto the setup in the left-hand view and selecting **Delete** from the context menu. All following setups will be removed as well.
- A setup which has a setup observation only to the following traverse station can also be used as the start point of the traverse. However, since such traverses do not have an initial backsight, they can only be processed by entering a **Start Azimuth** in the **Traverse Properties** dialog or by using the **Helmert 2D method**.

Delete a Traverse

Enables you to delete traverses in the  **TPS-proc** component.



1. Right-click on a  **Traverse** in the tree view and select **Delete** from the context menu.
2. Press **Yes** to confirm or **No** to exit without deleting the traverse.

Note:

- If you select more than one traverse then all of them can be deleted at once.
- If a traverse is deleted all included setups will be kept.

Traverse Report

To get an overview on the results of a traverse calculation you may invoke the **Traverse Report**.

- In the **TPS-proc** tree view right-click on a  Traverse in the  **Traverses** node and select **Traverse Report** from the context menu.

Alternatively: Right-click in the upper part of the **Traverse view** (in the Booking Sheet) and select **Traverse Report** from the context menu.

The report opens in a stand-alone window and is listed in the **Open Documents** list bar.

Stand-alone reports can be saved as HTML files or printed:

- To save a report as an HTML file right-click inside the report and select **Save As....**
- To print a report right-click inside the report and select **Print**. A **Print Preview** is also available from the context menu.
- To select the **contents** and the **format** of the report right-click and select **Properties...** from the context menu or click  in the **Reports** toolbar. For further details refer to: [Configure a Report](#).

Note:

- The contents of a Traverse Report always reflect the current status of the traverse calculation. If the traverse is **re-calculated** with different settings the report has to be invoked again.

When the report has been configured to display all possible sections it presents you with the following bits of information:

- Project Information**
- Traverse Information**
- Processing Parameters**
- Traverse Results**
- Traverse Station Differences**
- Observations**

Project Information

[Example:](#)

Project Information

Project name:	Traverse Final
Date created:	11/11/2005 13:55:32
Coordinate system name:	utm32
Application software:	LEICA Geo Office 3.0

This section gives you general information on the **Project Properties**, like the project name, creation date and time and the attached coordinate system.

If information has been entered in the [Dictionary](#) page of the Project Properties dialog these pieces of information will be added to this section of the report.

Traverse Information

[Example:](#)

Traverse Information

General:

Traverse Id:	TRAV
Time:	11/11/2005 12:56:33
Traverse Start Point:	1003
Traverse End Point:	1015
Number of Points:	7
Total Length:	421.278 m

Accuracies:

1D Accuracy:	1 / 39636.987	
2D Accuracy:	1 / 9811.689	
Length of Error:	0.043 m	
Direction of Error:	389.5015 gon	
Length Error:	0.033 m	✓
Max. Length Error:	0.205 m	
Cross Error:	0.027 m	✓
Max. Cross Error:	0.219 m	
Max. Height Correction:	-	
Max. Height Error:	0.010 m	
Angular Misclosure:	0.0284 gon	✓
Max. Angular Error:	0.0665 gon	
Misclosure in Departure:	-0.007 m	
Misclosure in Latitude:	0.042 m	
Misclosure in Height:	0.011 m	

This section supplies you with **General** information on the traverse for which the report has been invoked, such as the **Traverse Id**, its **Start** and **End Point**, the **Number of Points** (stations) included in the traverse and its **Total Length**.

Furthermore you get a list of detailed information on the **Accuracies** that have been achieved with the current calculation. The listed values correspond to the properties listed in the [Traverse Properties: General](#) page.

If the traverse has been adjusted with the **2D Helmert** method the two **Common Points** will be listed together with the calculated **Shift**, **Rotation** and **Scale factor**. **Length errors** and **Cross errors** will not be displayed.

Processing Parameters

[Example:](#)

Processing Parameters

Angle Balancing

Method: Equally

Traverse Adjustment

Method: Compass Rule

Height Balancing

Method: No Distribution

Calculated Scale

Scale: 0.99963298

Apply to survey observations: No

The **Processing Parameters** (i.e. the **Methods** for the **Traverse Adjustment**, the **Angle Balancing** and the **Height Balancing**) as set for the current calculation are listed. Additionally, the **Calculated Scale** is given together with the information whether it has been applied to connected Survey Observations or not.

Traverse Results

[Example:](#)

Traverse Results

Station	Easting	Northing	Height	Orientation
1003	546617.137 m	5250531.198 m	449.515 m	72.2483 gon
1005	546533.214 m	5250509.095 m	450.296 m	72.2459 gon
1006	546455.453 m	5250463.243 m	450.303 m	72.2504 gon
1007	546432.822 m	5250518.633 m	449.938 m	72.2590 gon
1009	546412.360 m	5250569.144 m	449.693 m	72.2631 gon
1011	546409.928 m	5250624.829 m	449.307 m	72.2694 gon
1015	546479.676 m	5250649.955 m	449.541 m	72.2790 gon

The results of the current traverse calculation are listed: Each **Station** is listed with its current local grid coordinates (**Easting**, **Northing** and **Height**) and its current **Orientation**. The **Check Points** are listed with their currently calculated local grid coordinates and the coordinate **Differences** to their **Control** triplets. The less these differences are the better the traverse calculation fits.

The items listed in this report section correspond to the items listed in the **Traverse Properties: Stations** page and the **Traverse Properties: Check Points** page.

Traverse Station Differences

[Example:](#)

Traverse Station Differences

Station	Delta Easting	Delta Northing	Delta Height
1003	0.0000 m	0.0000 m	0.0000 m
1005	0.0107 m	-0.0089 m	0.0000 m
1006	0.0219 m	-0.0181 m	0.0000 m
1007	0.0293 m	-0.0242 m	0.0000 m
1009	0.0360 m	-0.0297 m	0.0000 m
1011	0.0429 m	-0.0354 m	0.0000 m
1015	0.0521 m	-0.0430 m	0.0000 m

This section displays the differences in Easting, Northing and Height between the initial *Reference* triplet coordinates and the re-calculated *Reference* triplet coordinates for all traverse station points.

Observations

[Example:](#)

Observations

Setup Point Id	Backsight Point Id	Foresight Point Id	Hz	V	Slope Dist.	Horiz. Dist.
1003	1004	-	0.0000 gon	100.1207 gon	99.192 m	99.147 m
1003	-	1005	211.3594 gon	99.5961 gon	86.824 m	86.784 m
1005	1003	-	11.3594 gon	100.6485 gon	86.828 m	86.785 m
1005	-	1006	193.8321 gon	100.0669 gon	90.308 m	90.268 m
1006	1005	-	393.8321 gon	100.1476 gon	90.310 m	90.270 m
1006	-	1007	303.0472 gon	100.6027 gon	59.872 m	59.843 m
1007	1006	-	103.0472 gon	99.8044 gon	59.866 m	59.839 m
1007	-	1009	303.2339 gon	100.5013 gon	54.529 m	54.503 m
1009	1007	-	103.2339 gon	99.9126 gon	54.529 m	54.505 m
1009	-	1011	324.9526 gon	100.6324 gon	55.766 m	55.738 m
1011	1009	-	124.9526 gon	99.7506 gon	55.775 m	55.750 m
1011	-	1015	5.7087 gon	99.9423 gon	74.172 m	74.139 m
1015	1011	-	205.7087 gon	100.3825 gon	74.169 m	74.135 m
1015	-	1016	0.3403 gon	100.4482 gon	99.769 m	99.722 m

This section corresponds to the contents of the Traverse Booking Sheet in the [TPS-Processing: Traverse View](#). For each Station the averaged backsight and foresight observations are listed.

Traversing techniques

Various types of Traverse-processing are supported in the office software. The availability of the different computation methods depends on how the traverse is built and for which points *Control* coordinates are available.

In the diagrams below the following abbreviations are used:

- A ... Start point of the traverse with the first station setup.
- B ... End point of the traverse with the last station setup.
- A0 ... Initial Backsight at point A.
- B0 ... Final Foresight at point B.
- 1, 2, (3) ... Points within the traverse.

Traverse closed in position

Control coordinates are available for start point, end point, initial backsight and final foresight. This is the recommended method. Angular and coordinate misclosures can be calculated and distributed. Instead of *Control* coordinates for the initial backsight a *Start Azimuth* can alternatively be used. Instead of *Control* coordinates for the final foresight an *End Azimuth* can alternatively be used.

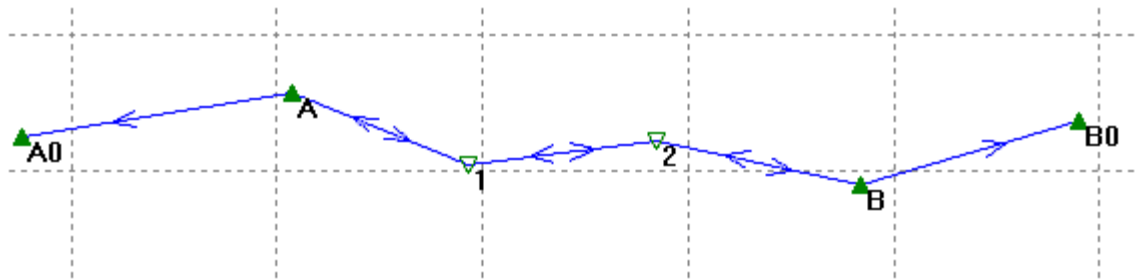

Traverse closed in position – without angular closure

If *Control* coordinates are available for start point, end point and initial backsight, but not for the final foresight, then only coordinate misclosures, but no angular misclosure can be calculated and distributed. Instead of *Control* coordinates for the initial backsight a *Start Azimuth* can alternatively be used.

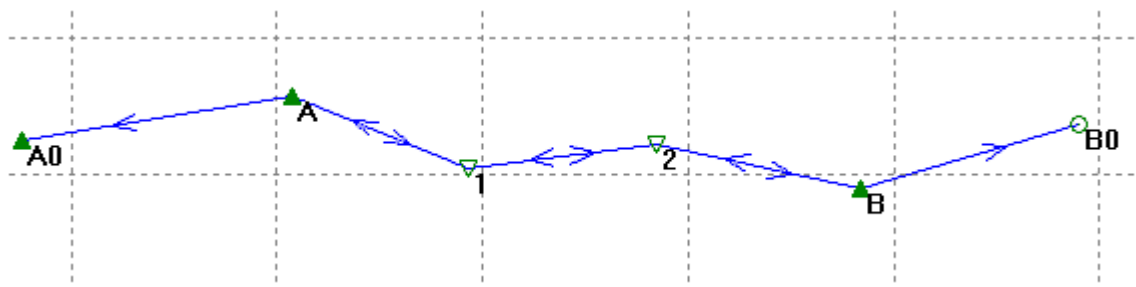

Open (flying) traverse

If *Control* coordinates are only available for start point and initial backsight (or alternatively a *Start Azimuth* is given) neither angular nor coordinate misclosures can be calculated and the traverse is not controlled in any way. However, it is still possible to calculate new station coordinates and update the sideshots.

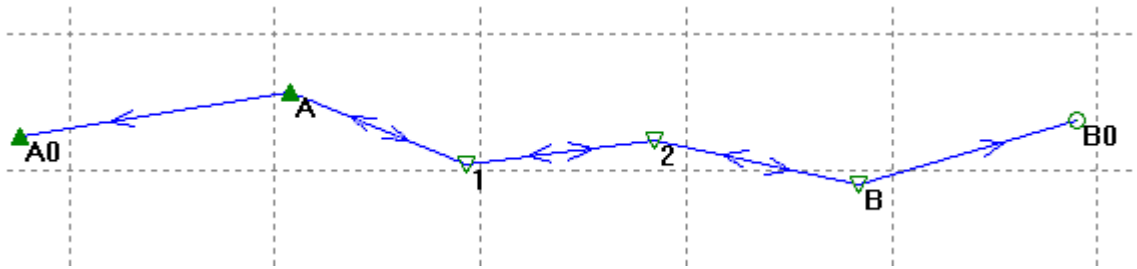

Minimally constrained traverse

If two *Control* coordinates are available, one for either start point A or initial backsight A0, and one for either end point B or final foresight B0, then the traverse can be transformed to the given *Control* coordinates by using the *2D Helmert Adjustment Method*. A typical example is a traverse starting on a known *Control* point (A) and closing on a known point without occupying the final *Control* point (B0) with the instrument. Angular and coordinate misclosures cannot be calculated.

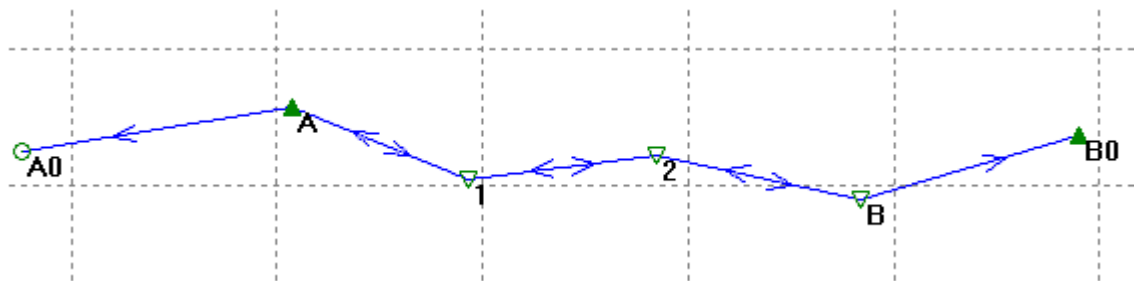

Note: When choosing **Adjustment Method 2D Helmert** the height misclosure will be calculated between the given heights of the two used *Control* points (A and B0 in this case), and not between the start and end point.

Closed loop traverse

The case of a traverse building a geometrically closed loop can be considered as a special case of a traverse closed in position, where start point and end point co-incide ($A=B$) and the instrument has been set up on the start point again. For this case no *Control* coordinates are required for A0 and/or B0 to calculate the angular misclosure.

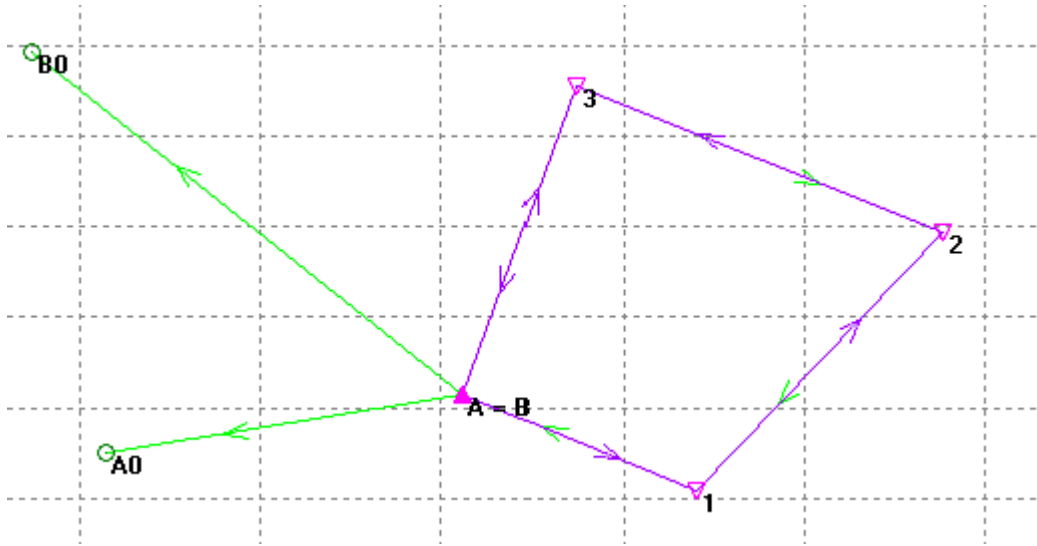

A loop traverse can also be built without setting up the instrument on the start point again by using the end point B as the initial backsight ($A0=B$) and the start point A as the final foresight ($B0=A$). Angular and coordinate misclosures will be calculated without the need for *Control* coordinates on points A and B. For the distribution of coordinate misclosures a distance must have been measured for the final traverse leg.

For this type of closed traverse loop no **End Azimuth** can be entered in the **Traverse Properties**. A **Start Azimuth** can be used to define the azimuth of the initial backsight (= final traverse leg).

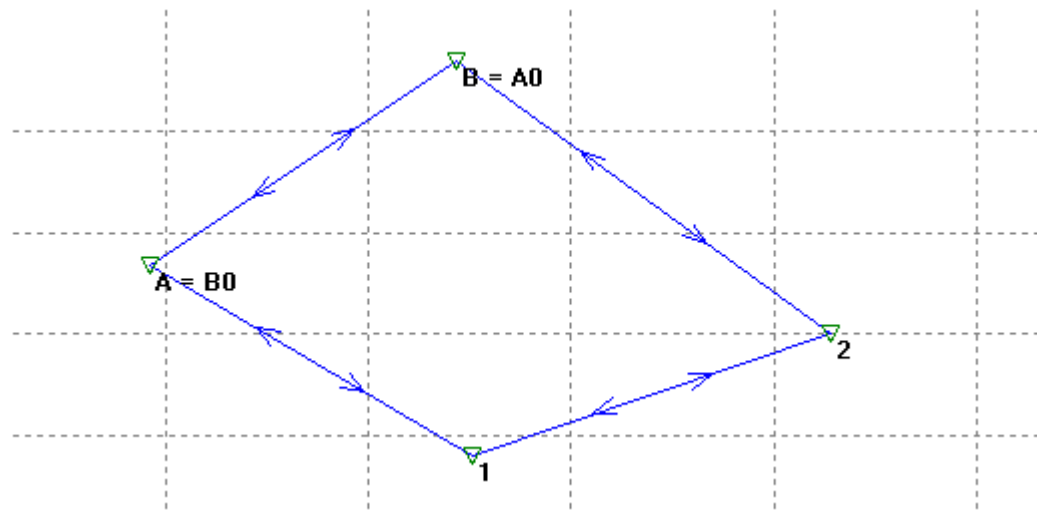

Note:

- If a traverse contains setups on any of the side shots (“loose traverse legs”) these can automatically be adjusted when storing the traverse results by using the **TPS Processing Guide**.

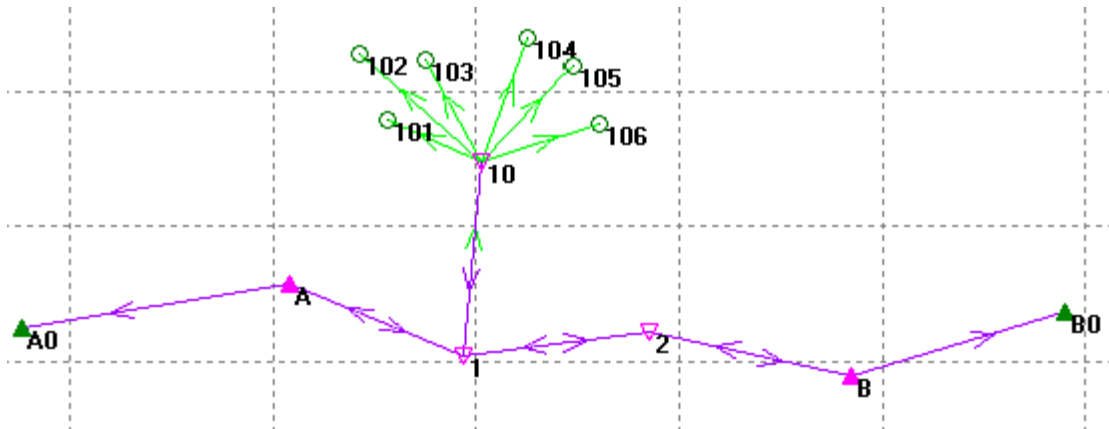

- For all cases in which *Control* coordinates are required, it is only necessary that *Control* triplets are stored for the point. They do not have to be the *current* triplet.

Traverse-processing Parameters

Traverse-processing Parameters

Select the computation parameters before you recalculate a traverse. The parameters can be changed individually, but system default settings are also available for all parameters.

After a traverse has been recomputed the **Traverse-processing Parameters** can be displayed in the [Traverse Report](#).

[How to modify the Traverse Processing Parameters](#)

The Traverse-processing Parameters Property-Sheet consists of the following pages:

[Traversing](#)

[Angle Balance](#)

[Height Balance](#)

See also:

[Traversing techniques](#)

Traverse-processing Parameters: Traversing

Adjustment method:

Choose the method how the coordinate misclosure (Easting, Northing) shall be distributed.

If you select **Compass Rule** the coordinate misclosure will be distributed with respect to the length of the traverse legs. The Compass Rule assumes that the biggest error comes from the longest traverse observations. This method is suitable when the precision of the angles and distances are approximately equal.

If you select **Transit Rule** the coordinate misclosure will be distributed with respect to the coordinate changes in Easting and Northing. Use this method if the angles were measured with a higher precision than the distances.

If you select **No Adjustment** the coordinate misclosures will **not** be distributed to the station coordinates.

If you select **2D Helmert** the traverse will be adjusted by a 2D Helmert transformation. Shift, Rotation and Scale factor will be computed and applied to the traverse.

Max. Length Error:

The tolerance for the Length Error is defined as $F = a + b \cdot L + c \cdot \sqrt{L}$. This formula contains the constants **a**, **b** and **c** and the total traverse length **L**. If the computed Length Error exceeds the Max. Length Error, a warning message will be displayed and the Length Error will be marked in the [Traverse Report](#).

Max. Cross Error:

The tolerance for the Cross Error is defined as $F = a + d \cdot L + e \cdot n \cdot \sqrt{n}$. This formula contains the constants **a**, **d** and **e** and the number of stations **n**. If the computed Cross Error exceeds the Max. Cross Error, a warning message will be displayed and the Cross Error will be marked in the [Traverse Report](#).

Apply Scale to survey observations

Tick this checkbox, if you wish to apply the scale factor resulting from the traverse computation to all survey observations connected to any of the setups contained in the traverse. If this setting is active the geometrical ppm stored with these survey observations will be changed, which in turn affects the measured point coordinates of all connected survey points when being applied.

Note:

- **Control** coordinates have to be stored for the **Start** and **End** Point in the traverse if you wish to calculate and distribute the coordinate misclosure by either the **Compass Rule** or the **Transit Rule**.
- The **Compass Rule** is also known as the **Bowditch** method.
- If you choose to adjust the traverse by a **2D Helmert** transformation it is not necessary to define a max. length error and a max. cross error. The corresponding functionality will not be available. The scale factor is automatically applied as part of the transformation.
- A summary of the different ways in which a traverse may be measured is given in the overview topic: [Traversing techniques](#).

Traverse-processing Parameters: Angle Balance

Adjustment method:

Choose the method how the angular misclosure shall be distributed.

If you select **Equally** the angular misclosure will be divided by the number of traverse angles and the same correction will be applied to each setup.

If you select **By Distance** the angular misclosure will be distributed with respect to the length of the traverse legs. The shorter a traverse leg is, the bigger the correction will be.

If you select **No Distribution** the angular misclosure will not be distributed to the traverse angles.

Max. Angular Error

The tolerance for the Angular Error (in 0.01 gons) is defined as $F = a + (b/L) + (n-1) \cdot \sqrt{n}$. This formula contains the constants **a** and **b**, the total traverse length **L** and **n**, the number of stations. If the computed **Angular Misclosure** exceeds the **Max. Angular Error**, a warning message will be displayed and the Angular Misclosure will be marked in the [Traverse Report](#).

Note:

- The selected Angle Balance Method will be applied to calculate the coordinate misclosures. To distribute the coordinate misclosures to the station coordinates select the Adjustment Method in the [Traversing](#) page as required.
- **Control** coordinates have to be stored for the **Start** Point, the **initial** Backsight Point, for the **End** Point and for the **last** Foresight Point of the traverse if you wish to calculate and distribute the angular misclosure either **Equally** or **By Distance**.
- A summary of the different ways in which a traverse may be measured is given in the overview topic: [Traversing techniques](#).

Traverse-processing Parameters: Height Balance

Adjustment method:

Choose the method how the height misclosure shall be distributed.

If you select **Equally** the height misclosure will be divided by the number of stations and the same correction will be applied to each station height.

If you select **By Distance** the height misclosure will be distributed with respect to the length of the traverse legs. The longer a traverse leg is, the bigger the correction will be.

If you select **No Distribution** the height misclosure will not be distributed to the station heights.

If you select **Keep Heights** the heights of the stations will be kept and only the position information of the traverse stations will be updated.

Max. Height Error per station point

Define the tolerance for the Height Misclosure.

If the computed **Height Misclosure** divided by the number of stations exceeds the **Max. Height Error per station**, a warning message will be displayed and the Height Misclosure will be marked in the [Traverse Report](#).

Note:

- If *2D Helmert* has been chosen as the **Adjustment method** in the [Traversing](#) page, then the height misclosure will be calculated and distributed between the two *Control* points of the Helmert transformation. For all other methods the height misclosure is always calculated and distributed between start and end point of the traverse.
- A summary of the different ways in which a traverse may be measured is given in the overview topic: [Traversing techniques](#).

Modify Traverse Processing Parameters

1. In the **TPS-Proc** view right-click and select **Processing parameters...** from the context menu.
Alternatively: Select  **Processing parameters...** from the **TPS-Proc** main menu or click on the corresponding toolbar button in the **Standard** toolbar.
2. The following pages will be displayed in the **Configure Traverse-processing Parameters** dialog:

Traversing
Angle Balance
Height Balance

The **default** Processing settings can be changed under **Tools - Options: Default Parameters**.
3. Make your changes or press the **Default** button to apply the default values to the parameters in the selected page.
4. Press **OK** to confirm or **Cancel** to abort the function.

Note:

- If you intend to modify the default values, you may do so under **Tools - Options**.

Traverse Properties

Traverse Properties

This Property-Sheet enables you to display the **Traverse properties** and to **recalculate** a traverse stored in the **TPS-proc** view.

1. Right-click on a Traverse in the tree-view or in the Traverse Booking Sheet and select **Properties...** from the context menu.

The following pages will be displayed in the **Traverse Properties** dialog:

General
Check Points
Stations

2. In the **General** page you can **recalculate** the traverse. Additionally, you may modify the Traverse Id.

Press **OK** to confirm or **Cancel** to abort the function.

Traverse Properties: General

This property page enables you to display general information on SmartWorx traverses. To get information on the different ways in which a traverse may be measured, please, see the overview topic: [Traversing techniques](#).

Date/ Time:

Displays the Date and Time when the traverse was created. If the traverse was measured using the Traverse Application on the instrument this is the time when the application was started. For manually created traverses this is the time when the traverse was stored in the office software.

Traverse Id:

Unique identification of the traverse. You may deactivate the traverse by clearing the **Active** check box. This will exclude all setups included in the traverse and all associated observations from the adjustment computation.

Use start/ end Azimuth:

Check one or both of these options if you want to enter and use a given **start** and/ or **end Azimuth** value for calculating the traverse instead of calculating the azimuth from *Control* coordinates of the initial backsight point (Known Backsight on the first point in the Traverse) and/ or from *Control* coordinates of the final foresight point (known foresight on the last point in the Traverse).

Note: Only if these options are selected will the entered Azimuth values be used.

If *Control* triplets exist for the start and the end point of the traverse then the **coordinate** misclosures may be computed in addition to the angular misclosure.

If the **Adjustment Method 2D Helmert** has been chosen in the [Traverse-processing Parameters: Traversing](#) page the following options will be available instead of the 'Use start/ end Azimuth' functionality:

Start/ End Point:

From the combo boxes select the point(s) that shall serve as the **start** or **end** point of the traverse in the calculation of the 2D Helmert transformation.

As start point either the first point in the traverse **or** the initial backsight point may be selected **if for both** *Control* triplets exist. As end point either the last point in the traverse **or** the final foresight point may be selected **if for both** *Control* triplets exist.

Properties

Lists the Traverse Properties. To save or print the properties select **Save as...** or **Print** from the context menu.

The misclosures of the computation (**angular** and **coordinate misclosures**) are shown. The **Length Error**, **Cross Error** and **Height Error** are derived from the coordinate misclosures and are listed together with the maximum allowed errors as specified in the [Traverse-processing Parameters](#). The **1D** and **2D Accuracies** are displayed as a ratio of the error against the **Total Distance**.

If the traverse has been adjusted with the **2D Helmert** method the two **Common Points** will be listed together with the calculated **Shift**, **Rotation** and **Scale factor**. **Length errors** and **Cross errors** will not be displayed then.

Use the  button to [exchange the coordinate system](#) from which the coordinates of the traverse setups have been derived. This functionality is available for setup coordinates that have been derived on a **Smart Station** instrument with a preliminary coordinate system.

Recalculation of traverses:

1. To recalculate a traverse using the selected **Traverse-processing Parameters** press **Recalculate**. The currently selected **Adjustment method** is displayed above the **Properties** view.
2. Press **OK** to apply the changes. On all stations the *Reference* point triplets will be replaced with the newly computed coordinates. The orientations will be updated for each setup in the traverse. All connected measured point triplets calculated from the modified setups will be updated according to the new station coordinates and new orientations.

Note:

- To calculate the angular misclosure either the **start** and **end Azimuth** values must be given or **Control** coordinates must be stored for the **Start** Point, the **initial** Backsight Point, for the **End** Point and for the **last** Foresight Point of the traverse.

To calculate coordinate misclosures (Latitude, Departure and Height) **Control** coordinates must be stored for the **Start** Point and for the **End** Point of the traverse.

If neither **start** and **end Azimuth** values nor **Control** coordinates are given a warning message will be issued and the coordinates of traverse stations will be calculated without angular balance and without any distribution of the coordinate misclosures.

To set the *Control* values for the local grid coordinates (**Easting**, **Northing** and **Height**) as required go to the **Point Properties: General** page and select **Point Class Control**.

Traverse Properties: Check Points

This property page enables you to display information on the Check Points that have been measured from any of the setups included in the traverse. All points within the selected traverse to which **Survey Observations** (sideshots) have been made and which in addition have a **Control** triplet stored, will be listed as a Check Point.

Traverse Id:

Displays the Id of the selected traverse.

Report view:

Lists all Check Points that have been measured for the selected traverse with their local grid coordinates. When the traverse is **re-calculated** in the **General** page the **dEasting**, **dNorthing** and **dHeight** values are updated for all check points taking into account the newly computed orientations. The smaller the differences are the better the traverse fits.

Traverse Properties: Stations

This property page enables you to display information on the station coordinates that have been calculated for all setups in the traverse.

Traverse Id:

Displays the Id of the selected traverse.

Report view:

The report view displays the local grid coordinates and the orientations currently stored or newly computed for all stations contained in the traverse. When a traverse has been recalculated the differences between the stored coordinates and orientations and the newly computed values is displayed as well.

When leaving the **Traverse Properties** with **OK** the reference triplets and the orientations will be updated for all setups that are listed in the **Stations** page.

Traverse View

TPS-Processing: Traverse View

If a  **Traverse** is selected in the **TPS-Processing** tree-view, the right-hand view changes to display the **Traverse Booking Sheet** and a corresponding graphical representation of the traverse, the so-called **Traverse View**.

The **Traverse Booking Sheet** lists the observations to the **Backsight** Point Id and to the **Foresight** Point Id for each Setup in the traverse. Direction (**Hz**), Zenith Angle (**V**), **Slope Distance**, **Horizontal Distance** and **Height Difference** can be displayed. If multiple measurements exist for a Foresight or Backsight point then the averaged observations will be displayed.

Setup Point Id	Backsight Point Id	Foresight Point Id	Hz	V	Slope Dist.	Horiz. Dist.	Height Diff.
1003	1004	-	0.0000	100.1207	99.1920	99.1475	0.0327
1003	-	1005	211.3594	99.5961	86.8244	86.7838	0.7714
1005	1003	-	11.3594	100.6485	86.8280	86.7846	-0.7890
1005	-	1006	193.8321	100.0669	90.3083	90.2679	0.0007
1006	1005	-	393.8321	100.1476	90.3103	90.2697	-0.0138
1006	-	1007	303.0472	100.6027	59.8721	59.8427	-0.3716
1007	1006	-	103.0472	99.8044	59.8656	59.8386	0.3591
1007	-	1009	303.2339	100.5013	54.5287	54.5027	-0.2542



The Traverse Booking Sheet offers the following functionality:

- To modify a **Setup Point Id** right-click onto the Setup Point Id and select **Modify...** from the context menu.
- To modify the **Traverse-processing Parameters** right-click into the booking sheet and select **Processing Parameters** from the context menu.
- To **recalculate** a traverse right-click into the booking sheet, select **Properties...** from the context menu and press the **Recalculate** button in the **Traverse Properties: General** page.
- To view the stored **Traverse Properties** in an **HTML Report** right-click into the booking sheet and select **Traverse Report** from the context menu.
- To exchange the coordinate system for all setups included in the traverse right-click into the booking sheet and select **Exchange Coordinate System** from the context menu.

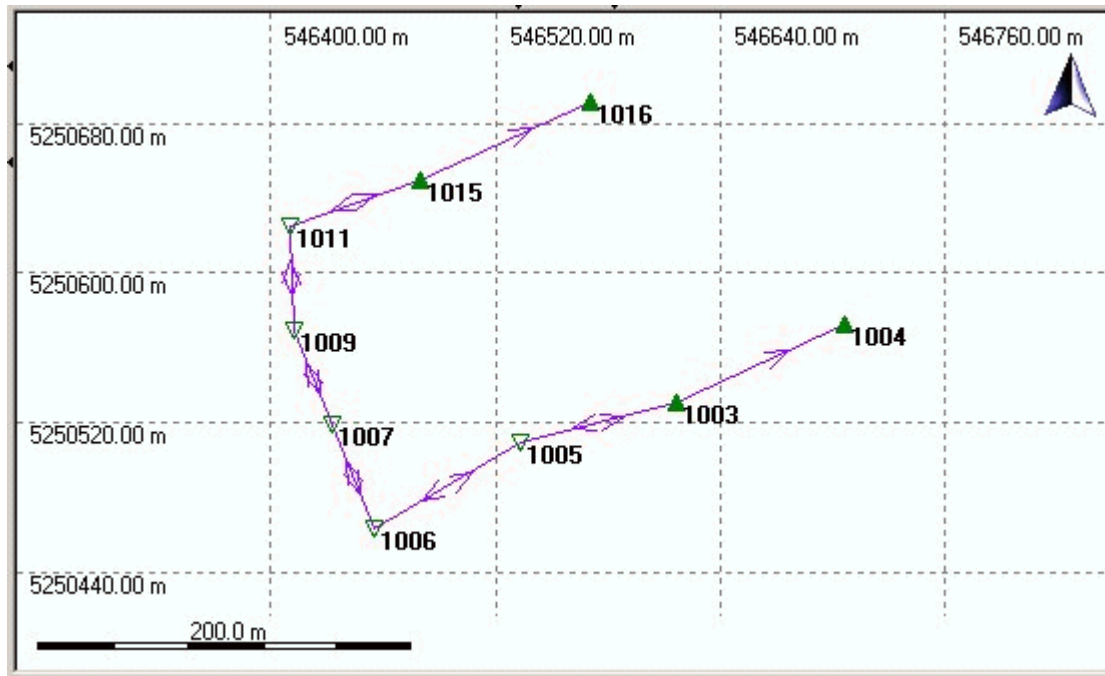
The lower part of **Traverse View** offers a graphical representation of the data given in the booking sheet. All **Setups** and  **Traverse Observations** are displayed. **Survey observations** are not included to provide a clearer overview on the traverse.



The Traverse View offers the following functionality:

- To **zoom in or out** of the view right click and select **Zoom In**, **Zoom Out** or **Zoom 100%** from the view's background menu. Alternatively, use the corresponding toolbar buttons (, ) from the **View** toolbar.
- By default, **Panning** is switched on so that you can comfortably navigate within the view.
- To modify the Graphical Settings right-click and select **Graphical Settings...** from the background menu. Via the Graphical Settings functionality you may even decide to activate a **background image** for the view. The background image has to be attached to the project first. You may do so in the **Background Image** page of the **Project Properties** dialog.

Zooming (Traverse-processing)

The original scale of the **Traverse View** is selected in such a way that the whole traverse fits into the view.

Via the Zoom functionality different sections of the traverse may be enlarged to inspect the details.

To Zoom in:

1. In the graphical view right-click and select **Zoom In** from the background menu.
Alternatively: Select  from the **Toolbar**.
The symbol of the cursor changes to a magnifying glass.
2. Draw a rectangle around the area you want to enlarge. To do so click the left mouse button and keep it pressed while positioning the cursor to the lower right-hand-corner of the area you want to enlarge.

The section of the traverse within the rectangle will be enlarged to the extent of the graphical view.

To Zoom out:

In the graphical view right-click and select **Zoom Out** or **Zoom 100%** from the background menu.

Alternatively: Select  or  from the **Toolbar**.

The **Zoom 100%** functionality resizes the view to its original extents in one step.

Sets of Angles

Create a Sets of Angles Application

Sets of angles **measured** with the SmartWorx **Sets of Angles Application** will automatically be listed as  **Sets of Angles** in the **TPS-Proc** view.

If sets of angles have been measured in the field without making use of the Sets of Angles application on the instrument then the sets may be manually created in the office software.

To create a Sets of Angles Application:

1. In the  **TPS-Proc** view right-click on  **Sets of Angles** in the tree view and select **New Sets of Angles...** from the context menu.

Alternatively, right-click in the **Sets of Angles** report view and select **New Sets of Angles...** from the context menu.

The **New Sets of Angles Wizard** starts up.



2. In the **Start** page of the wizard select the TPS *Reference* point for which the Sets of Angles application shall be defined. Click **Next**.
3. In the **Select Setup** page select one of the Setups that have been measured or manually created on this *Reference* point.

Note: Only those Setups will be offered for selection that have not been used already for creating a Sets of Angles application, i.e. a Setup can only be used once for creating a Sets of Angles application.

Click **Next**.

4. In the **Select Sets of Angles Observations** page select the **Number of Sets** that shall be included in the application. Each set has to be manually created then.

In the left-hand report view (multi-)select the target observations that shall be included into the selected set. If the report view is sorted by **Date/ Time** (default) the required observations can easily be selected in a single block. Face I and II may be included in a single step.

Press the  button to add the selected observations to the right-hand side graphical view. To remove an observation again from the graphical view, select it in the graphical view and press the  button. Alternatively, right-click on the observation in the graphical view and select **Remove** from the context menu.

5. Repeat step 4. for each set. The sets have to be selected one after the other from the combo box at the top.
6. Click the **Finish** button to calculate and create the Sets of Angles.

The newly calculated Sets of Angles will be stored and added to the list of  **Sets of Angles** in the **TPS-Proc** view.

To get an overview on the Sets of Angles data including information on the instrument that has been used in the field, on the mean errors calculated for the sets of angles and on the point results, the residuals and face differences invoke and see the [Sets of Angles Report](#).

Note:

- In a set a point may only be selected once. It must not but may be selected in face I and II. Face I is sufficient, though. Observations that cannot be selected any more because another observation to the same target point in the same face has already been assigned, are indicated by a different color.
- All points belonging to the first set must also be included in all following sets. It must be the same points, not less and no more.
- The selected number of sets have to be created completely before the dialog may be left with **Finish**.

Tip:

- To view/ edit the **Observation Properties** right-click on an observation either in the left-hand report view or in the graphical view and select **Properties...** from the context menu.

To view the **Point Properties** right-click on a point in the graphical view and select **Properties...** from the context menu.

- To zoom in and out of the graphical view right-click and select **Zoom In/ Out** from the background menu.
- **Panning** may be switched on from the background menu to be able to comfortably navigate within the graphical view.
- To modify the settings for the graphical view right-click and select **Graphical Settings...** from the background menu. If a background image is attached to the project it may be switched on in the graphical view via the **Graphical Settings...**

Delete a Sets of Angles Application

Enables you to delete a **Sets of Angles application** in the  **TPS-Proc** component.







1. In the Sets of Angles report view highlight a **Sets of Angles** and select **Delete** from the context menu.
2. Press **Yes** to confirm or **No** to exit without deleting.

Note:

- The **observations** included in the Sets of Angles to be deleted **will be kept**.

Sets of Angles Report

To get an overview on one or more Sets of Angles in your project you may invoke the **Sets of Angles** Report.

- In the **TPS-proc** tree view open a  **Sets of Angles** in the  **Sets of Angles** node and click on  **Report** in the  **Results** folder to open the **Sets of Angles** report embedded in the right-hand report view.
- In the **TPS-proc** tree view right-click on a  **Sets of Angles** in the  **Sets of Angles** node and select **Sets of Angles Report** from the context menu to open the report in a stand-alone window. The report will then be listed in the **Open Documents** list bar.

Alternatively: Right-click on a Sets of Angles in the **Sets of Angles** report view and select **Sets of Angles Report** from the context menu.

Note: To get a report on several Sets of Angles at a time multi-select the Sets of Angles to be included in the report in the **Sets of Angles** report view, right-click into the selection and select **Sets of Angles Report** from the context menu.

Embedded reports and stand-alone reports can be saved as HTML files or printed:

- To save a report as an HTML file right-click inside the report and select **Save As...**
- To print a report right-click inside the report and select **Print**. A **Print Preview** is also available from the context menu.
- To select the **contents** and the **format** of the report right-click and select **Properties...** from the context menu or click  in the **Reports** toolbar. For further details refer to: [Configure a Report](#).

When the report has been configured to display all possible sections it presents you with the following information:

- Project Information**
- Instrument Information**
- Sets of Angles Information**
- Point Results**
- Residuals/ Face Differences**

Project Information

[Example:](#)

Project Information

Project name:	SOA
Date created:	18-06-07 13:30:06
Coordinate system name:	None
Application software:	LEICA Geo Office 8.0

This section gives you general information on the **Project Properties**, like the project name, creation date and time and the attached coordinate system.

If information has been entered in the [Dictionary](#) page of the **Project Properties** dialog these pieces of information will be added to this section of the report.

Instrument Information

[Example:](#)

Instrument Information

Instrument Type:	TCRP1202
Instrument Serial Number:	220035
Instrument Height:	2.000 m
Setup Time:	15-05-06 14:21:45

This section gives you information on the instrument that was used in the field to measure the Sets of Angles. The instrument type and serial number are listed, together with the instrument height and the time when the Sets of Angles were measured.

Sets of Angles Information

[Example:](#)

Sets of Angles

Time:	15-05-06 14:21:45
Number of Points:	5
Number of Sets:	3
Mean Error of avg direction (Hz):	0.0002 gon
Mean Error of avg vertical angle (V):	0.0002 gon
Mean Error of avg distance:	0.000 m
Mean Error of single direction (Hz):	0.0004 gon
Mean Error of single vertical angle (V):	0.0004 gon
Mean Error of single distance:	0.000 m

Tolerances	Hz	V	Distance
Residuals	0.0010 gon	0.0010 gon	0.005 m
Face Diff.	0.0010 gon	0.0010 gon	0.005 m

This section lists the number of measured sets together with the number of points included in the sets. The accuracies (mean errors) are listed for the reduced and single observations.

The Tolerance values as set in the [Tolerances](#) dialog are listed, too.

Point Results

[Example:](#)

Point 11

Mean of all sets (Hz): 31.2259 gon
 Mean of all sets (V): 88.4875 gon
 Mean of all sets (Dist): 249.023 m

Set	Use	Hz	V	Distance	Target height	Refl.Type		
1	✓	31.2248 gon	88.4876 gon	249.023 m	1.67500 m	Leica Circ Prism		
2	✓	31.2266 gon	88.4875 gon	249.023 m	1.67500 m	Leica Circ Prism		
3	✓	31.2263 gon	88.4873 gon	249.023 m	1.67500 m	Leica Circ Prism		

Set	Use	Res. Hz	Res. V	Res. Dist.	Face Diff Hz	Face Diff V	Face Diff Dist	Tolerance exceeded
1	✓	0.0011 gon	-0.0002 gon	0.000 m	0.0003 gon	0.0011 gon	0.000 m	⚠
2	✓	-0.0007 gon	-0.0000 gon	0.000 m	0.0009 gon	0.0017 gon	0.001 m	
3	✓	-0.0004 gon	0.0002 gon	0.000 m	0.0008 gon	0.0019 gon	0.001 m	

For each target point a sub-section is added to the report in which the observations (direction, distance and vertical angle) are listed as averaged from face I and II and reduced to the first point in each set. Additionally, the **Target Height** and **Reflector Type** used in each set are given.

At the top of each sub-section the mean observations averaged from all sets are listed for a point.

If in the [report template](#) the **Residuals/ Face Differences** section is selected to be switched on for display in the report then underneath the point results the residuals of the single observations to their mean values and the differences between the Face I and Face II observations are listed for each measured set.

If one of the tolerance values as defined in the [Sets of Angles Tolerances](#) dialog is exceeded for at least one of the residuals or one of the face differences in a set then a warning (⚠) will be issued in the **Tolerance exceeded** column.

Sets of Angles Tolerances

To invoke the Sets of Angles Tolerances dialog:

- Right-click in the Sets of Angles report view and select **Sets of Angles Tolerances...** from the context or background menu.

In this dialog you may define tolerance values for the residuals and face differences resulting from a Sets of Angles calculation.

Residuals Hz, V, Slope Dist.:

Define a tolerance for the residuals resulting from a Sets of Angles calculation for the reduced direction, vertical angle and slope distance.

Face Differences Hz, V, Slope Dist.:

Define a tolerance for the differences between face I and II resulting from a Sets of Angles calculation for the direction, vertical angle and slope distance within a single set.

If one of the tolerance values is exceeded a warning message () is issued in the [Sets of Angles Properties](#) and in the [Report](#).

If one of the options is de-selected the corresponding values resulting from a calculation will not be checked for whether the tolerance is exceeded.

Sets of Angles Properties

Sets of Angles Properties

This Property-Sheet enables you to display the **Sets of Angles properties** and to **recalculate** a Sets of Angles application stored in the **TPS-proc** view.

1. Right-click on a Sets of Angles application in the tree-view or in the corresponding report views and select **Properties...** from the context menu.

The following pages will be displayed in the Sets of Angles Properties dialog:

General

Targets

2. In the **General** page you can view some general properties and result values. In the **Targets** page you can view the results for each target point and **recalculate** the application.

Press **OK** to confirm or **Cancel** to abort the function.

Sets of Angles Properties: General

This property page enables you to display general information on a Sets of Angles application.

Station Point Id:

Displays the Point Id of the selected station setup. For every point multiple Sets of Angles applications may be stored.

Date/ Time:

Displays the Date and Time when the Sets of Angles application was created. If the application was measured using the SmartWorx TPS Sets of Angles application this is the time when the application was started. For manually created sets of angles this is the time when the application was stored in the office software.

Instrument Type / SN:

Displays the type of instrument used and its serial number.

Properties

Lists the general Sets of Angles properties. To save or print the properties select **Save as...** or **Print** from the context menu.

The number of sets and the number of target points in each set are displayed. Information on the accuracies is given for the observations (horizontal angle, vertical angle and slope distance) reduced from all sets and for single observations.

Recalculation of Sets of Angles:

To recalculate a Sets of Angles application switch to the [Targets](#) page, where you can **activate** or **de-activate** sets or target points (for all sets) and recalculate the application.

Sets of Angles Properties: Targets

This property page enables you to display the observations for each target point (averaged for face I and II and reduced to the first point) in each set, to **activate** or **de-activate** sets or target points (for all sets) and **recalculate** the application.

Station Point Id:

Displays the Point Id of the selected station setup.

Target Point Id:

From the combo box select one of the target points included in the Sets of Angles application. The report view below will change to display the set results for the selected target point. To de-activate a target point for **all** sets from the calculation de-select the **Activate** checkbox. The point will be de-activated in **all** sets.

Report view

Displays the following results for each set of the selected target point.

H_z, V, Slope Dist.: Observations averaged for face I and face II and reduced to the first point. The horizontal distance and height difference can be displayed as well.

Residuals H_z, V, Slope Dist.: Difference between the set result and the mean of all sets. If one of the residuals exceeds the **tolerances** a warning symbol is displayed for this set.

Face Differences H_z, V, Slope Dist.: Absolute difference between face I and face II for each set. If one of the face differences exceeds the **tolerances** a warning symbol is displayed for this set.

To deactivate a complete set de-select the checkbox in the report view for any of the target points. The set will be de-activated for **all** target points.

Computed Mean of all Sets:

Displays the current, reduced observations resulting from all sets for the selected target point. The computed observations will be updated when you press the **Recalculate** button.



Recalculation of Sets of Angles:

To recalculate the Sets of Angles application proceed as follows:

1. Decide if you wish to de-activate a set or target point for all sets. Press **Recalculate** to display the updated results.
2. Leave the property page with **OK** to store the newly calculated result.

Graphical Settings

Graphical Settings (TPS-processing)

In the  **Setups** component the **Graphical Settings** dialog enables you to configure the map view included in the **New Setup** wizard or in the **Edit Setup** dialog. In the  **Traverses** component the **Graphical Settings** dialog enables you to configure the graphical **Traverse View**. In the  **Sets of Angles** component the **Graphical Settings** dialog enables you to configure the map view included in the **New Sets of Angles** wizard.

You may configure which items shall be displayed and select the colors for the graphical elements and the font for text items.

1. From the view's background menu (right-click) select **Graphical Settings...**
2. In the **Graphical settings** dialog use the tabs to switch between the following pages:
 - View**
 - Grid**
 - Color**
 - Font**
3. Make your changes or press the **Default** button to apply the default values to the parameters of a page.
4. Press **OK** to confirm or **Cancel** to abort the function.

Graphical Settings: View

This Property-Page enables you to define which graphical elements shall be displayed in the [Traverse View](#) or in the [New Setup/ Edit Setup](#) map views or in the [New Sets of Angles](#) map view.

General:

Grid

Check to display a coordinate grid.

Note: To configure the grid see: [Grid](#).

North Arrow

Check to display an arrow in the upper right corner pointing to the north.

Scale Bar

Check to display a Scale Bar in the lower left corner of the view. The Scale bar will alter its size and description to suit the scale at which you are zoomed in. Additionally, the scale bar will appear on any printout that you make, when activated.

Legend

Check to display a legend listing the point symbols of all possible point classes.

Coordinate Tracking (only available in the Traverse View)

Check to display the mouse coordinates in the Status Line.

Background Image

Check to display the referenced image which has been attached to the project as a background image.

Data:

Point Ids

Check to display the Point Identifications.

Note: To configure the font see: [Font](#).

Graphical Settings: Color

This Property-Page enables you to set the color of the database items.

- In the **Color** column double-click onto the corresponding color field and select a color from the in-line edit combo box.

Setup/ Traverse Observations/ Sets of Angles Observations

Select a color from the in-line edit combo box to set the color of the Setup or Traverse measurements or of the Sets of Angles measurements.

Background

Select a color from the in-line edit combo box to set the color of the view's background.



Level Processing

Level-Processing



The processing of Level data is fully automated and no user interaction is required.

- The Level Processing may be accessed via the  **Level-Proc** Tab from within a project window.

When the Level Processing View is entered, all jobs contained in the active project are displayed in the Tree-View on the left-hand side.

- Click on the main folder  **Jobs** to display all jobs contained in the project in the right-hand **Jobs Report-View**.
- Click on a  **job** to obtain detailed information on the line(s) in the right-hand **Lines Report-View**.
- Click on a  **line** to obtain detailed information on the observations in the **booking sheet** on the right-hand side. A graphical representation of the level line is given in the **Level Line view** underneath the booking sheet.

Use the different **Report Views** to start processing on different levels:

- To process **a specific level line** start the processing from within the **booking sheet**. Right-click in the booking sheet and select **Process** from the context-menu. Alternatively, select  **Process** from the Level-Proc main menu or the toolbar.
- To process **several lines** in a job in a single processing run select the lines to be processed in the **Lines Report View** and start the processing. Right-Click on one of the selected lines and select **Process** from the context-menu. Alternatively, select  **Process** from the Level-Proc main menu or the toolbar. The selected lines will be processed.

If you select a job in the **Tree-View** and start the processing then from the main menu **all lines** contained in the job will be processed in one run.

- To process **all lines in several jobs** in a single processing run select the jobs to be processed in the **Jobs Report-View** and start the processing. Right-click on one of the selected jobs and select **Process** from the context menu. Alternatively, select  **Process** from the Level-proc main menu or the toolbar. The selected jobs will be processed.

If you select **Jobs** in the **Tree-View** and start the processing then from the main menu **all lines in all of the jobs** contained in the project will be processed in one run.

After the Level-Processing is completed the results can be viewed and stored in the  **Results View**.

Select from the list below to learn more about Level-Processing:

[Jobs Report View](#)

[Lines Report View](#)

[Booking sheet](#)

[Level Line view](#)

[Join or split level lines](#)

[De-activate Points and Observations in the Booking Sheet](#)

[Modify Point Heights in the Booking Sheet](#)

Create Control

Level-processing Parameters

Processing Level lines

Results View

Level-Processing: Jobs Report View

If the  **Jobs** folder is selected in the Level-Proc Tree-View then on the right-hand side of the Level-Processing View by default the following items of the Level project are listed:

Job name:

Identification of the job(s) contained in a project.

Operator name:

Identification of the man/ woman who has operated the instrument in the field for that particular job.

Comment 1/2:

Possibly entered annotations as to e.g. bad weather conditions, obstructions in the sight etc.

Date/ Time:

Date of recording the line.

Right-click on the Report-View column headings and select **Columns...** to configure the visible columns of the Jobs Report-View.

Possible operations in the Jobs Report View:

- Select **Modify** from the context-menu to modify **Job Name**, **Operator Name** or the **Comments**.
- Select **Delete** from the context-menu to delete job(s) from the project.
- Right-click and select **Processing Parameters...** to **modify the Level-processing parameters**.
- If one or more jobs are highlighted and you select **Process** from the context menu, all lines within all selected jobs will be automatically processed.

Level-Processing: Lines Report View

If a job is selected in the Level-Proc Tree-View then on the right hand side of the Level-Processing View by default the following items of the Job data are listed:

Line Name

Identification of the line(s) contained in a job.

Method

Observation method used with a line. The available methods are:

BF: Backsight - Foresight

BFFB: Backsight - Foresight - Foresight - Backsight

aBF: alternate Backsight - Foresight

aBFFB: alternate Backsight - Foresight - Foresight - Backsight

Staff ID 1/2

Identification of the two staffs that have been used for measuring the level line.

Start Point ID

Point Identification of the start point.

Time

Date of recording the line.

Right-click on the Report-View column headings and select **Columns...** to configure the visible columns of the Lines Report-View.

The following additional columns may be displayed:

No. Observations:

Indicates the total number of observations. At each setup at least two observations are taken depending on the **observation mode**. For BFFB sequences at least four observations are taken plus possibly repeated measurements and intermediate sights.

No. Stations:

Indicates the number of setups in the line.

Line Length:

Indicates the length of the line as the sum of the backsight and foresight distances at each station.

Dist. Balance:

Is the difference between the distance to the backsight point and the foresight point.

Total Station Diff.:

Indicates the sum of all station differences as computed at each station in the level line.

Comments:

Possibly entered annotations as to e.g. bad weather conditions, obstructions in the sight etc.

Possible operations in the Lines Report View:

- Select **Modify** from the context-menu to modify **Line Name**, **Staff ID 1/ 2** or the **Comments**.
- Select **Delete** from the context-menu to delete individual lines. If you delete the last line in a job, the job will also be deleted.
- Right-click and select **Join level lines** to connect existing level lines.
- Right-click and select **Processing Parameters...** to **modify the Level-processing parameters**.

- If one or more lines are highlighted and you select **Process** from the context menu, the selected lines will be automatically processed.

Join Level Lines

In the  **Level-Processing** component you may select separate Level Lines to be **joined** into one.

- Right-click onto a  **Level Line** in the tree-view or in the **Lines Report View** and select **Join Level Line...** from the context menu.

Alternatively: Right-click into the **Booking Sheet** of a Level Line to invoke the functionality.

In the **Join Level Line** dialog:

1. Select the lines to be joined in the right-hand report view and press  to add each line to the left hand report view. The right-hand report view offers all lines contained in all jobs for selection. The lines in the left-hand report view will be joined in the order in which they have been added to the view. The **Name** of the New Line will be the same as the name of the line that has first been added to the left-hand view.

Note: You can join two or more lines from the same or from different jobs.

2. Press **OK** to join the lines.

The tree-view changes to show the newly joined line in the  **Job** folder that contained the line which has first been selected for joining. The lines that have been joined to the first line disappear.

Note: The height difference observations indicating the total height difference of a level line are automatically updated when joining level lines.

Level Lines may also be split. To split a line:



- Right-click on a line in the **Booking Sheet** indicating the levelled point height and select **Split Level Line** from the context menu.

Note: A line may be split on any levelled point in a line.

Processing Level lines

The computation of level lines is an automated procedure without the need for any user interaction.

To process a Level line:

- Click on a  Level line in the tree-view of the Level-Proc tab to open the **booking sheet**.
- Right-click in the booking sheet and select **Process** from the context-menu or select  from the Toolbar or the Level-Proc main menu.

When the computation is completed by default the view is switched automatically to the **Results View**, where the processing results can be inspected and stored. To change the default behaviour go to **Tools - Options - Default Parameters** and change the corresponding setting.

Tip:

- More than one level line may be processed at a time. You may process several lines in a job, complete jobs or even several jobs in a project in a single processing run. Select the lines or jobs to be processed in the **Lines Report View** or the **Jobs Report View**. Select **Process** from the context-menu or from the Toolbar or the Level-Proc main menu.

Note:

- If the level line to be processed comprises an invalid Point Id sequence, which does not allow processing, then that computation run will be cancelled and a warning message will be issued.
- To **undo** a processing run for a special level line right-click in the booking sheet and select **Reset Heights** from the context menu.

Booking Sheet

Level-Processing: Booking sheet

If a Line  is selected in the Level-Processing Tree-View, the Report-View on the right-hand side changes to display the so-called booking sheet and a corresponding graphical representation of the level line (the so-called **Level Line view**). The booking sheet is the electronic representation of the level fieldbook and, therefore, has a lot of similarities with the classic, hand-written level fieldbook. By default the following items of the level line are listed:

Point Id	Back	Intrm.	Intrm. Type	Fore	Distance	Height	Point Class	Point Subclass	Code	Comment
<input checked="" type="checkbox"/> 1000						1000.0000	Control	Fixed in Height		
<input checked="" type="checkbox"/> 1000	1.2263				3.79					
<input checked="" type="checkbox"/> 1				1.3862	3.80					
<input checked="" type="checkbox"/> 1				1.3862	3.80					
<input checked="" type="checkbox"/> 1000	1.2264				3.79					
<input checked="" type="checkbox"/> 1						999.8402	Measured	None	-	

Point Id

Point identification.

Back

Backsight staff reading. Depending on the **observation method** you have one or two backsights for one instrument setup.

Intrm.

Intermediate staff readings. Next to the level line you might want to take intermediate sights. The heights of such intermediate points are determined by single, uncontrolled staff readings. Intermediate points are staff setups which are not part of the line but which are supposed to be read correctly when the line turns out to be inside the **limits** set for processing.

Intrm. Type

Defines the type of measurement in the **Intermediate** column. The Intrm. Type may be either *Intermediate Measurement*, *Set out* or *Measurement only*.

Fore

Foresight staff reading. Depending on the **observation method** you have one or two foresights for one instrument setup.

Distance

Distance between the level instrument and staff 1/ 2. Ideally the distances should be the same to cancel errors due to curvature and refraction.

Height

The height of a point as calculated in relation to the Start Height. Control heights are fixed, while measured heights are adjusted when a level line is **processed** in LGO.

Point Class

Type and/ or source of a point height. Points may be either of **class** *Measured*, *Averaged* or *Control*. Note that only classes *Measured* and *Control* are displayed in the booking sheet. *Averaged* heights are only shown in the Points View.

Point Subclass

The point subclass supplies additional information relevant to the individual class. Points of **class** *Measured* may have **subclass** *Raw* or *Processed*. Points of **class** *Averaged* always have **subclass** *None*. Points of **class** *Control* always have subclass *Fixed in Height*.

Code

This column displays the Thematical code which has been attached to the points.

Comment

For each measurement on the DNA a comment can be recorded. This is normally related to the measurement. The user can also enter a comment for a measurement in the booking sheet.

Right-click on the Report-View column headings and select **Columns...** to configure the visible columns of the Booking sheet.

The following additional columns may be displayed:

Diff. B1-B2

For **BFFB sequence** measurements the difference between the first and second backsights is recorded. Ideally the difference should be 0.

S/O Diff. Hgt

The Set Out Difference in Height is the difference between the height measured and the fixed height (the height planned).

S/O Diff. Delta Hgt

Is the difference between the measured difference in height and the planned difference in height. (This Diff. Hgt utilises the Backsight measurement.)

S/O Diff. Dist

Is the difference between the measured distance to a set out point and the planned distance to a setout point.

Diff. F1-F2

For **BFFB sequence** measurements the difference between the first and second foresights is recorded. Ideally the difference should be 0.

Source

Indicates where the measurements came from. Measurements downloaded from the Leica digital levels will have the source *Measured*.

Station No.

Indicates at which Station the measurements were taken. Each level line starts at Station 1.

Station Diff.

The station difference is used for **BFFB (and aBFFB)** sequence measurements. It is the sum of the differences in the backsights and foresights.

Total Station Diff.

The Total Station Difference is a running total of the Station Differences for every station in the level line up until that point.

Dist. Balance

The Distance Balance is the difference between the distance to the backsight point and the foresight point.

Total Dist.

The Total Distance is a running total of the Backsight distance and Foresight distance at each station.

Easting

If the Easting has been recorded it can be displayed in the booking sheet.

Northing

If the Northing has been recorded it can be displayed in the booking sheet.

Diff Hgt.

The Height Difference is the difference between the height of the Backsight point and Foresight point of a setup.

Sequ. Diff. Hgt.

The Sequential Height Difference is the height difference between successive intermediate, set-out or foresight points of a station, in the order of measurement.

No. Measurements

Is the number of measurements taken by the instrument for that observation. This is displayed for measurement modes *rept. Single, mean, mean+s and median*.

Earth curv. corr.

Indicates whether the Earth Curvature Correction has been applied to the observations.

Int. time

This column shows the integration time for measurements. The NA3003 level has integration times of 2,3,4...9 seconds.

Measure mode

The measure mode indicates how the observations were taken. The DNA series levels have *single*, *repeat single*, *mean*, *mean+s* and *median* measure modes.

Spread

The spread is the difference between the highest and lowest observations in *repeat single*, *mean*, *mean+s* or *median* measure modes.

Std. Dev

This column shows the Standard Deviation of an observation recorded in *repeat single*, *mean*, *mean+s* or *median* measure mode. To edit one or more Standard Deviations highlight one or more staff reading and select [Edit Standard Deviations...](#) from the context menu.

Std. Dev. Mean

The Standard Deviation Mean is the Mean of all the Standard Deviations calculated in the level line up to that point. It can be used for finding the average variation in the measurements, rather than the variation for each observation.

Type

The Type indicates what sort of data the Booking Sheet line contains. *Backsight 1*, *Backsight 2*, *Foresight 1*, *Foresight 2*, *Intermediate Sight*, *Measurement Only*, *Set Out* and *Point Height* can all be displayed in lines of the booking sheet.

Most of the items in the booking sheet are read-only. The only items which may be modified in the office are:

- the Point Id
- the Height
- the Point Class and Subclass
- the [Standard Deviations](#)
- the Comment

In the Booking Sheet it is also possible to split a level line:

- Right-click on a line indicating the levelled point height and select **Split Level Line** from the context menu. A line may be split on any levelled point in a line, resulting in a new level line stored in the same job.

You can also invoke the functionality to [join level lines](#) from the context-menu in the Booking Sheet.

Select from below to learn more about the booking sheet:

[De-activate Points and Observations in the Booking Sheet](#)

[Modify Point Ids in the Booking Sheet](#)

[Modify Point Heights in the Booking Sheet](#)

[Edit Level Standard Deviations](#)

[Create Control \(Level\)](#)

[Point Classes and Subclasses \(Level\)](#)

[Changing Point Classes in the Booking Sheet](#)

[Join level lines](#)

[Level-processing Parameters](#)

[Processing Level lines](#)

[Level-Processing: Level Line view](#)

Level observation techniques

There are four major techniques how level lines may be observed.

Backsight - Foresight (BF):

The pattern for **BF** measurements is that you have one backsight to the previous point in the level line and one foresight to the next point in the level line. In between you may have as many intermediate sights as you like. For the intermediate points as well as for the next point in the level line point heights are calculated and saved together with the measurements in the GSI or DNA file.

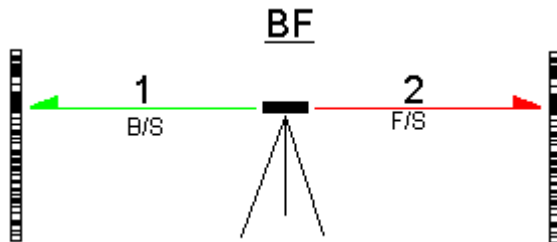

Booking Sheet example (BF):

Point Id	Back	Intrm.	Intrm. Type	Fore	Distance	Height
<input checked="" type="checkbox"/> 100						100.0000
<input checked="" type="checkbox"/> 100	1.7687				3.90	
<input checked="" type="checkbox"/> 1				1.7724	3.86	
<input checked="" type="checkbox"/> 1						99.9963
<input checked="" type="checkbox"/> 1	1.8753				3.85	
<input checked="" type="checkbox"/> 2				1.7722	3.86	
<input checked="" type="checkbox"/> 2						100.0994
<input checked="" type="checkbox"/> 2	1.7685				3.90	
<input checked="" type="checkbox"/> 3				1.7723	3.86	
<input checked="" type="checkbox"/> 3						100.0956
<input checked="" type="checkbox"/> INT 1		1.7723	Msmt.only		3.86	
<input checked="" type="checkbox"/> 3	1.7684				3.90	
<input checked="" type="checkbox"/> 4				1.8751	3.84	
<input checked="" type="checkbox"/> 4						99.9889
<input checked="" type="checkbox"/> 4	1.7721				3.86	
<input checked="" type="checkbox"/> 5				1.7684	3.90	
<input checked="" type="checkbox"/> 5						99.9926
<input checked="" type="checkbox"/> 5	1.8751				3.84	
<input checked="" type="checkbox"/> INT 2		1.7722	Msmt.only		3.86	
<input checked="" type="checkbox"/> INT 3		1.7722	Msmt.only		3.86	
<input checked="" type="checkbox"/> INT 4		1.7722	Msmt.only		3.86	
<input checked="" type="checkbox"/> 6				1.7686	3.90	
<input checked="" type="checkbox"/> 6						100.0991

Backsight - Foresight - Foresight - Backsight (BFFB):

The pattern for **BFFB** measurements is that you have first a backsight to the previous point in the level line, then a foresight to the next point in the level line. After that you make a second foresight to the next point and a final second backsight to the previous point before you leave the setup. After the first backsight you may have as many intermediate sights as you like. For the intermediate points as well as for the next point in the level line point heights are calculated and saved together with the measurements in the GSI or DNA file.

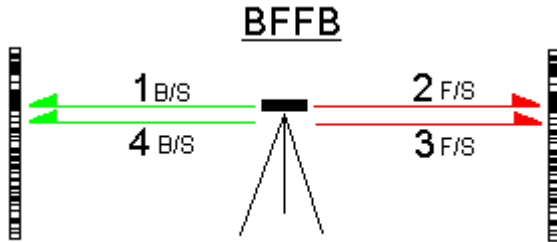

Booking Sheet example (BFFB):

Point Id	Back	Intrm.	Intrm. Type	Fore	Distance	Height
<input checked="" type="checkbox"/> 20						222.2220
<input checked="" type="checkbox"/> 20	1.7350				4.23	
<input checked="" type="checkbox"/> 21				1.8399	4.23	
<input checked="" type="checkbox"/> 21				1.8399	4.23	
<input checked="" type="checkbox"/> 20	1.7349				4.22	
<input checked="" type="checkbox"/> 21						222.1170
<input checked="" type="checkbox"/> 21	1.2561				4.13	
<input checked="" type="checkbox"/> 22				1.9433	4.29	
<input checked="" type="checkbox"/> 22				1.9433	4.29	
<input checked="" type="checkbox"/> 21	1.2560				4.13	
<input checked="" type="checkbox"/> 22						221.4298
<input checked="" type="checkbox"/> 22	1.8393				4.23	
<input checked="" type="checkbox"/> 23				1.2561	4.13	
<input checked="" type="checkbox"/> 23				1.2561	4.13	
<input checked="" type="checkbox"/> 22	1.8393				4.23	
<input checked="" type="checkbox"/> 23						222.0129

alternate Backsight - Foresight (aBF):

The pattern for **aBF** measurements is that after you had a backsight to point A and a foresight to point B on the first setup, you'll have first the foresight to point C and then the backsight to point B on the second setup. On the third setup you'll first take the backsight to point C again and so on. You alternate the observation sequence from one setup to the next, i.e. after you observed a **BF** sequence you always observe an **FB** sequence next. Doing so you may reduce errors caused by inaccuracies of the bubble.

Intermediate sights may be taken after each **BF/ FB** sequence. For the intermediate points as well as for the next point in the level line point heights are calculated and saved together with the measurements in the GSI or DNA file.

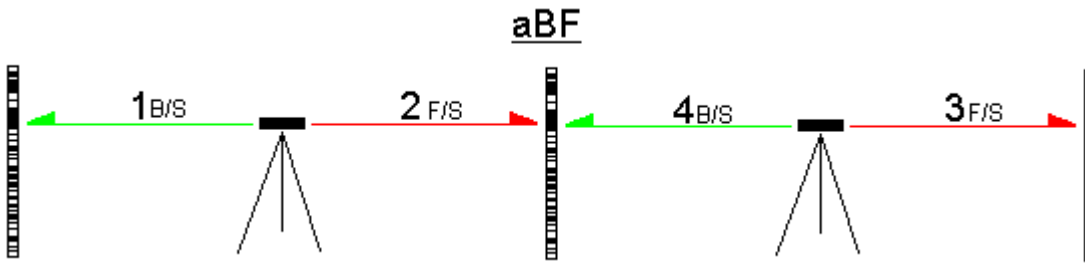

[Booking Sheet example \(aBF\):](#)

Point Id	Back	Intm.	Intm. Type	Fore	Distance	Height
<input checked="" type="checkbox"/> 500						500.5000
<input checked="" type="checkbox"/> 500	1.9426				4.28	
<input checked="" type="checkbox"/> 15				1.2561	4.13	
<input checked="" type="checkbox"/> 15						501.1866
<input checked="" type="checkbox"/> 16				1.8395	4.23	
<input checked="" type="checkbox"/> 15	1.2564				4.13	
<input checked="" type="checkbox"/> 16						500.6034
<input checked="" type="checkbox"/> 16	1.7426				4.23	
<input checked="" type="checkbox"/> 17				1.8404	4.23	
<input checked="" type="checkbox"/> 17						500.5056

alternate Backsight - Foresight - Foresight - Backsight (aBFFB):

The pattern for **aBFFB** measurements is that you observe a **BFFB** sequence on the first setup and an **FBBF** sequence on the next setup. The second next observation sequence will be a **BFFB** again and so on. You alternate the observation sequence from one setup to the next. Doing so you may reduce errors caused by inaccuracies of the bubble.

Intermediate sights may be taken after each **BFFB/ FBBF** sequence. For the intermediate points as well as for the next point in the level line point heights are calculated and saved together with the measurements in the GSI or DNA file.

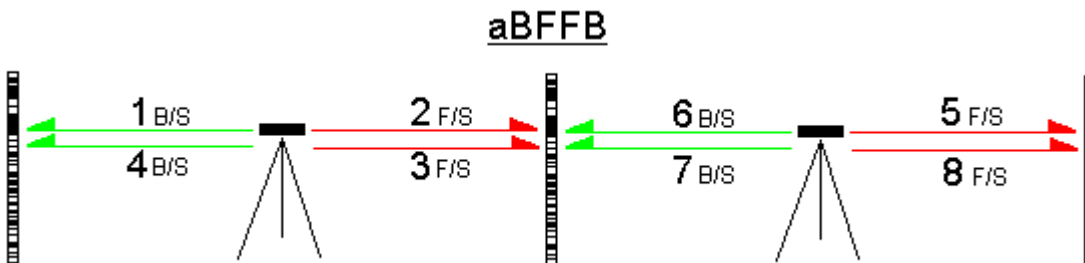

[Booking Sheet example \(aBFFB\):](#)

Point Id	Back	Intrm.	Intrm. Type	Fore	Distance	Height
<input checked="" type="checkbox"/> 1000						1000.0000
<input checked="" type="checkbox"/> 1000	1.2263				3.79	
<input checked="" type="checkbox"/> 1				1.3862	3.80	
<input checked="" type="checkbox"/> 1				1.3862	3.80	
<input checked="" type="checkbox"/> 1000	1.2264				3.79	
<input checked="" type="checkbox"/> 1						999.8402
<input checked="" type="checkbox"/> 2				1.7302	3.79	
<input checked="" type="checkbox"/> 1	1.5036				3.81	
<input checked="" type="checkbox"/> 1	1.5036				3.81	
<input checked="" type="checkbox"/> 2				1.7301	3.79	
<input checked="" type="checkbox"/> 2						999.6136

Point Classes and Subclasses (Level)

The **point class** describes the type and/or source of a point height. For each point there may exist more than one height in the LGO database.

The point classes represent the hierarchical order of a point's heights. The **Points View** displays the currently active point class for each point. By default the height with the highest class is active.

The point class in the **booking sheet** is independent of the currently active point class in the Points View. In the booking sheet the only two point classes to be displayed are *Measured* and *Control*. Other classes like for example *Averaged* may only be displayed in the Points View.

See also: [Changing Point Classes in the Booking Sheet](#)

The **point subclass** supplies additional information relevant to the individual class. The subclass indicates to the user the source the height came from.

The following list shows the Point Classes in ascending hierarchical order:

<u>Class Id</u>	<u>Description</u>
Measured	<p>Class of heights that have either been calculated by the Level instrument while the Level line was measured or that have been processed in LGO.</p> <p>Measured point heights can be modified in the booking sheet. Accordingly, all measured heights in the level line will be shifted by the same amount.</p> <p>Depending on the source of the measured height a point of this class may have the following subclasses:</p> <ul style="list-style-type: none"> - None: if the height is the measured raw height as it has been imported from the level instrument via Raw Data Import. - (Level) Processed: if the point has a height resulting from a processing run in LGO. <p>Note: <i>Measured</i> is the only point class which can comprise more than one height coordinate. If more than one measured height exists for a point the average will automatically be calculated. Points with an averaged height coordinate are awarded the additional class <i>Averaged</i>.</p>
Averaged	<p>Class of points for which more than one height of class <i>Measured</i> exists. The subclass of <i>Averaged</i> is always <i>None</i>.</p>
Control	<p>To process a level line in LGO at least one point must be of class <i>Control</i>. Control heights are retained in a processing run. They serve as the basis relative to which all other points are computed.</p> <p>By default the first point in a level line will be set to class <i>Control</i> when importing level raw data. It is assumed that the first point in a line has the known start height. To change the default and fix point heights manually in the booking sheet select Create Control from the context-menu.</p> <p>In level projects the subclass of <i>Control</i> points is <i>Fixed in Height</i>.</p> <p>Note: When you create a control you may fix the point's height to a different value than the measured height value. Changing the point height in creating a control does not simultaneously affect the heights of all other points. Neither the heights of all measured points in the line nor the heights of other controls will be shifted by the same amount.</p>

Changing Point Classes in the Booking Sheet

In the [booking sheet](#) a point can either have class *Measured* only or it can have both, class *Measured* and class *Control*. Since the booking sheet represents the classical level fieldbook points cannot be set to class *Averaged*.

If for a point both, a *Measured* **and** a *Control* height are stored in the database you may decide on which class you want to have displayed in the booking sheet.

- Right-click on the point class of such a point and select Modify from the context-menu. Alternatively, double-click on the point class and change the class to be displayed via inline editing.

Note:

- Only if the point's class is set to *Control*, its height will be hold fixed in the next processing run. If class *Measured* is active the control height will be ignored in processing

See also:

[Create Control \(Level\)](#)

[Point Classes and Subclasses \(Level\)](#)

Create/ Delete Control (Level)

Heights which are meant to be retained in a processing run have to be set to **point class** *Control*. For example, the heights of known points, which you have come across while measuring the level line, may be fixed by setting them to class *Control*.

To create a *Control* highlight the point in the booking sheet and select **Create Control** from the context-menu. A control height will be added for that point and its class will change to *Control*.

When creating a *Control* its height may either be left identical to the measured height or may be set to a different value. Changing the point height when creating a *Control* leaves all other heights in the line unaffected until the results of the next processing run are stored.

If a *Control* already exists for a particular point then the **Create Control** option changes to **Delete Control** in the context-menu. This allows you to remove a control height from a point.

Note:

- If a point has class *Control* but is **set back to** *Measured* in the booking sheet then the *Control* will be ignored in the next processing run. Only if *Control* is the **active** class then will the height of that point be hold fixed in processing.

See also:

[Point Classes and Subclasses \(Level\)](#)

[Changing Point Classes in the Booking Sheet](#)

[Modify Point Heights in the Booking Sheet](#)

Reset Heights

If you have processed a level line and adjusted the heights you may undo the computation run by resetting the heights.

- Right-click into the booking sheet and select **Reset Heights** from the context-menu. Alternatively, select **Reset Heights** from the Level-Proc main menu.

All heights in the line will be reset to those that have been initially imported during **Level Raw Data Import**. This means that manually entered *Control* heights, **modified** *Measured* heights as well as processed (**adjusted**) heights will be reset.

Activate/ De-activate Points and Observations in the Booking Sheet

In the **booking sheet** each measurement and point height has its own check-box for activating or de-activating the measurement or point height.

- Click on a check-box or select **Activate/ De-activate** from the context menu to activate/ de-activate individual observations or point heights.

Directly after import all checkboxes are active except for those measurements that have been repeated in the field. When you **de-activate measurements** to *line points* it depends on the **observation method** how the processing will react:

- If you de-activate a backsight or a foresight to a point in a **BF** or an **aBF** level line, then the line will be broken and all heights following the de-activated observation will not be calculated.

Example:

Point Id	Back	Fore	Distance	Height
<input checked="" type="checkbox"/> 1				111.1110
<input checked="" type="checkbox"/> 1	1.7343		4.23	
<input checked="" type="checkbox"/> 3		1.8390	4.23	
<input checked="" type="checkbox"/> 3				111.0064
<input checked="" type="checkbox"/> 3	1.2556		4.13	
<input checked="" type="checkbox"/> 4		1.9420	4.29	
<input checked="" type="checkbox"/> 4				110.3199
<input type="checkbox"/> 4	1.9421		4.29	
<input checked="" type="checkbox"/> 5		1.2553	4.13	
<input checked="" type="checkbox"/> 5				111.0066
<input checked="" type="checkbox"/> 5	1.8390		4.23	
<input checked="" type="checkbox"/> 6		1.7346	4.22	
<input checked="" type="checkbox"/> 6				111.1111
<input checked="" type="checkbox"/> 6	1.8398		4.23	
<input checked="" type="checkbox"/> 7		1.2552	4.13	
<input checked="" type="checkbox"/> 7				111.6956

BS de-activated (point 4 checkbox)

heights not processed (heights for points 5, 6, 7)

- If you de-activate a backsight and/ or a foresight to a point in a **BFFB** or an **aBFFB** level line, then the line remains unbroken. The station is re-computed using the remaining measurements.

Example:

Point Id	Back	Fore	Distance	Height
<input checked="" type="checkbox"/> 34				2.0731
<input checked="" type="checkbox"/> 8006	1.3517		20.21	
<input type="checkbox"/> 35		1.6312	19.29	
<input checked="" type="checkbox"/> 35		1.6312	19.29	
<input checked="" type="checkbox"/> 8006	1.3517		20.21	
<input checked="" type="checkbox"/> 8006				1.7935
<input checked="" type="checkbox"/> 35	1.5001		18.52	
<input checked="" type="checkbox"/> 8007		1.6910	18.39	
<input checked="" type="checkbox"/> 8007		1.6910	18.39	
<input checked="" type="checkbox"/> 35	1.5001		18.52	
<input checked="" type="checkbox"/> 35				1.6025

measurement un-checked (point 35 checkbox)

height still processed (heights for points 8006, 35)

- If you de-activate both backsights or foresights to a point in a **BFFB** or an **aBFFB** level line, then the line is broken and all heights following the de-activated observation will not be calculated.

Example:

Point Id	Back	Fore	Distance	Height
<input checked="" type="checkbox"/> 34	1.6326		19.29	
<input checked="" type="checkbox"/> 8006		1.3531	20.20	
<input checked="" type="checkbox"/> 8006		1.3530	20.20	
<input checked="" type="checkbox"/> 34	1.6326		19.29	
<input checked="" type="checkbox"/> 34				2.0731
<input type="checkbox"/> 8006	1.3517		20.21	
<input checked="" type="checkbox"/> 35		1.6312	19.29	
<input checked="" type="checkbox"/> 35		1.6312	19.29	
<input type="checkbox"/> 8006	1.3517		20.21	1.7935
<input checked="" type="checkbox"/> 8006				
<input checked="" type="checkbox"/> 35	1.5001		18.52	
<input checked="" type="checkbox"/> 8007		1.6910	18.39	
<input checked="" type="checkbox"/> 8007		1.6910	18.39	
<input checked="" type="checkbox"/> 35	1.5001		18.52	
<input checked="" type="checkbox"/> 35				1.6025

Observation de-activated

Observation de-activated

Height not processed

Height not processed

When you **de-activate the measurement** to an *intermediate* or a *set-out point* then that single height will not be calculated in processing.

Example:

Point Id	Back	Intm.	Intm. Type	Fore	Distance	Height
<input checked="" type="checkbox"/> 2	1.5320				20.78	
<input checked="" type="checkbox"/> 3				2.5306	14.13	
<input checked="" type="checkbox"/> 3						25.8033
<input type="checkbox"/> 2201		1.8399	Interm.		4.12	
<input checked="" type="checkbox"/> 2201						25.3330
<input checked="" type="checkbox"/> 2601		1.6717	Interm.		15.00	
<input checked="" type="checkbox"/> 2601						25.5012
<input checked="" type="checkbox"/> 3	1.3695				5.96	
<input checked="" type="checkbox"/> 4				1.8473	15.05	
<input checked="" type="checkbox"/> 4						25.3256

measurement un-checked

height not processed

If you **de-activate the height** of a *line point*, an *intermediate point* or a *set-out point* then the respective height will not be re-calculated when processed.

Example:

Point Id	Back	Fore	Distance	Height
<input checked="" type="checkbox"/> 1				111.1110
<input checked="" type="checkbox"/> 1	1.7343		4.23	
<input checked="" type="checkbox"/> 3		1.8390	4.23	
<input checked="" type="checkbox"/> 3				111.0064
<input checked="" type="checkbox"/> 3	1.2556		4.13	
<input checked="" type="checkbox"/> 4		1.9420	4.29	
<input type="checkbox"/> 4				110.3199
<input checked="" type="checkbox"/> 4	1.9421		4.29	
<input checked="" type="checkbox"/> 5		1.2553	4.13	
<input checked="" type="checkbox"/> 5				111.0066
<input checked="" type="checkbox"/> 5	1.8390		4.23	
<input checked="" type="checkbox"/> 6		1.7346	4.22	
<input checked="" type="checkbox"/> 6				111.1111

de-activated

height not calculated

Modify Point Heights in the Booking Sheet

To modify point heights in the [booking sheet](#) double-click on the height and change it via inline editing. Alternatively, right-click on a point height and select Modify from the context-menu.

- If you modify a **measured** height, then all measured heights in the level line will be shifted by the same amount.
- If you modify a **control** height, this leaves all other heights in the line unaffected until the results of the next processing run are stored.

See also:

[Point Classes and Subclasses \(Level\)](#)

[Create Control \(Level\)](#)

[Reset Heights](#)

[Changing Point Classes in the Booking Sheet](#)

Modify Point Ids in the Booking Sheet

To modify a Point Id in the [booking sheet](#):

- Double-click on the Point Id and change it via in-line editing.

Alternatively, right-click on a Point Id and select **Modify** from the context menu.

The Point Id will be changed for the **Foresight**, the **Point Id Height** and the **Backsight** row in the booking sheet.

Note:

- It is not allowed to change via **Modify** a Point Id to another Point Id for which a level measurement already exists in the open project. If you wish to re-name a Point Id to an already existing one then you have to go via the [Re-assign Measured triplet](#) functionality, which is available from the booking sheet context menu.

Edit Level Standard Deviations

With each level staff reading a standard deviation is stored and can be displayed in the [Booking sheet](#). Editing the standard deviation will modify the standard deviation of the levelled point height and the standard deviation of the [height difference observation](#) of the total level line.

To modify the standard deviation of level staff readings:

- Highlight one or more lines in the Booking Sheet indicating level height readings and select **Edit Standard Deviations...** from the context menu. Enter the value that shall be applied to the selected staff readings and press OK. The standard deviations for the point height and for the total level line will be updated.

Note:

- Standard Deviations for level height readings can also be applied during Level raw data import using the [Import Settings: Standard Deviations](#).

Level Line View

Level Processing: Level Line view

The Level Line view is a graphical representation of the data given in the [booking sheet](#). The profile of the selected level line is visualized, i.e. the rises and falls resulting from calculated point heights. Since the distances between the instrument setups and the staff setups are known a proportionally correct overview on the line structure may be provided.

A graphical representation of the backsight and foresight measurements as well as of the instrument and staff setups may be switched on or off via the [Graphical Settings](#).

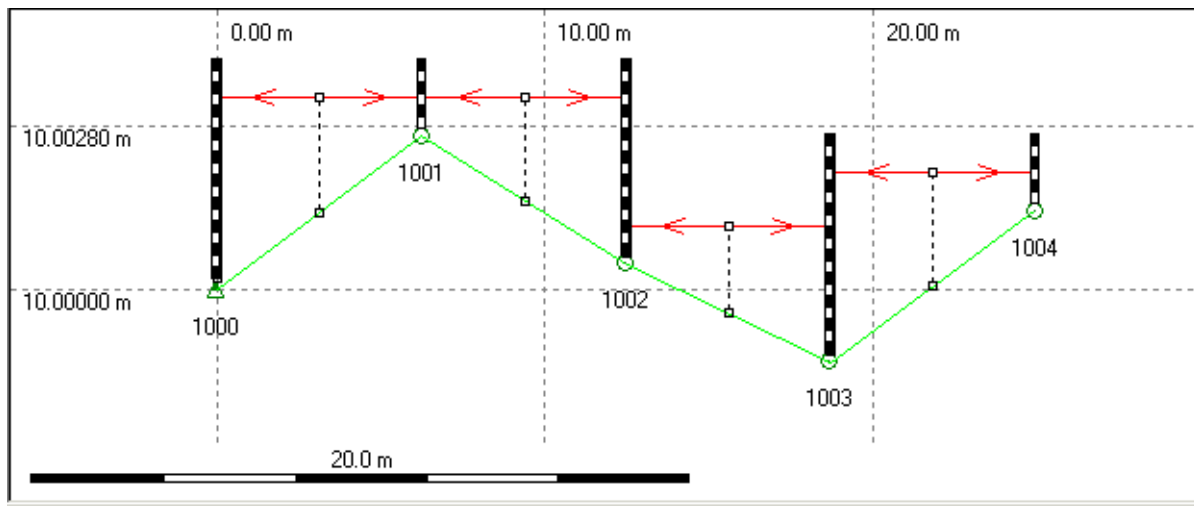

Select from below to learn more about the Level Lines view:

[Zooming \(Level-Processing\)](#)

[Vertical Exaggeration](#)

[Graphical Settings \(Level-Processing\)](#)

Zooming (Level-Processing)

The original scale of the graphical view is selected in such a way that all observations belonging to the selected level line fit into the view.



Via the Zoom functionality different sections of the level line may be enlarged to inspect the details.

To Zoom in:

1. In the graphical view right-click and select **Zoom In** from the background menu.
Alternatively: Select  from the **Toolbar**.
The symbol of the cursor changes to a magnifying glass.
2. Draw a rectangle around the area you want to enlarge. To do so click the left mouse button and keep it pressed while positioning the cursor to the lower right-hand-corner of the area you want to enlarge.

The section of the level line within the rectangle will be enlarged to the extent of the graphical view.

To Zoom out:

In the graphical view right-click and select **Zoom Out** or **Zoom 100%** from the background menu.
Alternatively: Select  or  from the **Toolbar**.

The **Zoom 100%** functionality resizes the view to its original extents in one step.

Note:

- You may change the vertical exaggeration by selecting **Vertical Exaggeration...** from the background context menu.

Vertical Exaggeration

When you open the [Level Line view](#), the profile of the selected level line is exaggerated in height to fit into the size of the view. You may change the vertical exaggeration by selecting **Vertical Exaggeration...** from the background context menu. Enter a new value or move the slider to modify the exaggeration factor for the heights.

Graphical Settings

Graphical Settings (Level-Processing)

The **Graphical settings** dialog enables you to configure the Level Lines view. You may configure which items to display and select the colors of graphical elements and the font for text items.

1. From the context menu (right-click) or the **View** main menu select **Graphical Settings....**
2. In the **Graphical settings** dialog use the tabs to switch between the following pages:

View
Grid
Color
Font

3. Make your changes or press the **Default** button to reset the parameters to their default values.
4. Press **OK** to confirm or **Cancel** to abort the function.

Graphical Settings: View

This Property-Page enables you to define which graphical elements shall be displayed in the Level Lines view.

General:

Grid

Check to display a level profile grid.

Note: To configure the grid see: [Grid](#)

Scale Bar

Check to display a Scale Bar in the lower left corner of the screen. The Scale bar will alter its size and description to suit the scale at which you are zoomed in. Additionally, the scale bar will appear on any printout that you make, when activated.

Legend

Check to display a legend listing the point symbols of all possible point classes.

Coordinate Tracking

Check to display the mouse coordinates in the Status Line.

Measurements/ Staves

Check to display the measurements to the levelled points and staff symbols on the levelled points.

Setups

Check to display the point of the instrument setup.

Data:

Point Ids

Check to display the Point Identifications.

Note: To configure the font see: [Font](#).

Graphical Settings: Color

This Property-Page enables you to set the color of the database items.

- In the **Color** column double-click onto the corresponding color field and select a color from the in-line edit combo box.

Measurements

Select a color from the in-line edit combo box to set the color of the levelling measurements (observations).

Level

Select a color from the in-line edit combo box to set the color of the levelled heights.

Level-processing Parameters

Level-processing Parameters

Select the computation parameters before you start your computation. The parameters can be changed individually, but system default settings are also available for all parameters.

After the computation has been performed the Level-processing Parameter settings used for the particular computation run are listed in the **Results Management** and may also be output via the [Summary Report](#).

[How to modify Level-processing Parameters](#)

The Level-processing Parameters Property-Sheet consists of the following pages:

[Level Line](#)

[Observations](#)

[Point Heights](#)

[Staff Corrections](#)

Level-processing Parameters: Level Line

Adjustment method

Choose adjustment per station or per distance. In case of adjustment per station the misclosure is equally divided among all stations. In case of adjustment per distance, the levelling distance is taken into account, because most systematic errors are proportional with this distance.

Misclosure E

The Misclosure tolerance of a Level line is defined as $E = a + b \cdot \sqrt{L}$. This formula contains the two constants **a** and **b** and **L**, the sum of the backsight and foresight distances. The sum of the backsight and foresight distances is averaged when measuring in the BFFB levelling sequence. **a** and **b** are empirically derived factors. **a** is the factor relating to the instrument (usually 0.002) while the **b** constant is a factor for each particular class of levelling.

1st order levelling $b = 0.005$

2nd order levelling $b = 0.008$

3rd order levelling $b = 0.012$

If the processing formula $E = b \cdot \sqrt{L}$ is required a 0.000 value can be entered in the Misclosure's **a** field. If one or more distances are missing in a level line, the misclosure tolerance is reduced to $E = a$.

Height error per station

The maximum Height error per station is equal to the Misclosure tolerance E divided by the number of stations.

Distance balance

The total Distance balance is defined as the sum of all backsight distances minus the sum of all foresight distances.

Level-processing Parameters: Observations

Double observation check

The Double observation check can only be applied when using a BFFB levelling sequence. BFFB levelling sequences imply that on each station four measurements are done: backsight (B1), foresight (F1), again foresight (F2) and again backsight (B2). The difference between the two backsights (B1-B2) and the difference between the two foresights (F1-F2) ought to be lower than the Double observation check. In an ideal situation these differences are zero.

Station difference

Like the Double observation check, the Station difference is also only determined in case of BFFB levelling sequences. The two height differences, (B1-F1) and (B2-F2), which can be calculated from the measurements ought to be the same in an ideal situation and therefore should not differ more than the Station difference tolerance.

Max. sight distance

The Maximum sight distance of fore- and backsights is set to restrict errors which increase with the distance.

Min. ground clearance

The Minimum ground clearance is the minimum staff reading to prevent errors due to lines of sight being close to the ground.

Stakeout difference

The Stakeout difference is the difference between the observed height and its fixed height. In an ideal situation this difference is zero.

Level-processing Parameters: Point Heights

Height spread

The Height spread tolerance is the maximum variation of the heights within a level line. It is the difference between the smallest and the largest height.

Maximum difference from fixed height

To restrict the difference of a calculated height from observations and any fixed height for a point, the 'Maximum difference from fixed height' tolerance is set.

Level-processing Parameters: Staff Corrections

Staff Corrections:

If this option is checked the following correction formula is applied to staff readings before they are used in processing:

$$L = L' \left[1 + \left(\alpha * (T - T_0) \right) * 10^{-6} \right]$$

with:

L	=	corrected staff reading (in metres)
L'	=	measured staff reading (in metres)
α	=	expansion coefficient (ppm/ C°)
T	=	temperature (C°)
T₀	=	calibration temperature (20 C°)

Expansion coefficient:

The expansion coefficient is the α value in the formula. This value varies depending on the type of staff used. Typical expansion coefficients are:

Invar	< 1 ppm/ C°
Dry Wood	5 ppm/ C°
Fibreglass	< 10 ppm/ C°
Aluminium	24 ppm/ C°

Temperature during Measurement:

The temperature during measurement is the **T** value in the formula. Enter the actual temperature determined while you were observing the level line to be processed.

Calibration Temperature:

The calibration temperature **T₀** is the temperature that the staff is calibrated for. This will normally be 20C°.

Modify Level-processing Parameters

1. From the context menu (right-click) select Processing Parameters.
2. In the Property-Sheet use the tabs to switch between the following pages:

[Level Line](#)
[Observations](#)
[Point Heights](#)
[Staff Corrections](#)

Change the default Processing settings under **Tools – Options**.

3. Make your changes or press the **Default** button to apply the default values to the parameters of a page.
4. Press **OK** to confirm or **Cancel** to abort the function.

Note:

- If you intend to modify the default values, you may do so under [Tools - Options - Default Parameters](#).

Adjustment

Adjustment

Adjustment is an optional component in LGO and Flex Office. It enables you to perform the following tasks:

- Network simulations based upon default observation precisions to find out how good the design of your network is before you measure. Details on selecting and using the design capabilities are given in [Using the Design capabilities](#).
- Network adjustment of GPS baselines and terrestrial data (directions, distances, zenith angles, azimuths and height differences) and detection of outliers within the network.

The Adjustment component uses observations and point coordinates within a project database. Refer to [Raw Data Import](#) on how to import raw data to a project.

GPS baseline information may also be imported via ASCII files. Additionally, observations may be imported by using the [Drag and Drop](#) capability.

If a Coordinate System is attached to a Project or if *WGS84* and *Local* coordinates are stored in your project, you may switch the view to display either *WGS84* coordinates or *Local* coordinates. The coordinate type is fixed to *WGS84 Geodetic* or *Local Grid* in the graphical views.

To comfortably navigate within the view [Panning](#) is, by default, switched on. The [Scroll to selected point](#) tool makes it easy to focus on a special point. To enlarge or reduce the view make use of the **Zoom** functionality.

- The adjustment component may be accessed via the  **Adjustment** Tab from within a Project window.

Select from the list below to learn more about Adjustment:

[New](#)

[Activate / De-activate](#)

[Delete](#)

[Zoom In](#)

[Zoom Out](#)

[Zoom 100%](#)

[Panning](#)

[General Parameters](#)

[Pre-analysis](#)

[Compute Network](#)

[Compute Loops](#)

[Store](#)

[Results](#)

[Observations View](#)

[Graphical settings](#)

[Point Properties](#)

[Observation Properties](#)

[All about Adjustment](#) - This topic offers basic ideas, mathematical concepts and stochastic models used in least squares adjustment.

[Note on adjusting GPS and Terrestrial measurements](#) - This topic offers steps to follow in computing least squares adjustments containing GPS and Terrestrial measurements.

Panning

Panning is a feature of most of the graphical views inside LGO. It allows you to comfortably move a view without having to scroll left and right and up and down.

- Click with the left mouse button into a graphical view (the cursor changes into a 'hand') and keep it pressed to move the displayed area into any direction.

The Pan mode is by default switched on.

- To switch the Panning functionality off click the corresponding toolbar button  or de-select **Panning** from the view's background menu.
- To temporarily switch off the Panning mode keep the **Shift**-key pressed.

To select a series of points and/ or observations while Panning is **switched on**:

- Keep the **Shift**-key pressed to drag a rectangle around the items you want to select.

Keep the **Shift**-key or the **Ctrl**-key pressed to select individual items or draw separate rectangles around several groups of items.

To 'Drag and Drop' data items while Panning is **switched on**:

- Keep the **Shift**-key pressed while dragging and dropping (copying and pasting) data items according to the rules given in the corresponding topic.

Note:

- Panning is also available in the graphical views inside **Wizards**. In Wizards the Panning functionality is by default switched off.

Zoom In

1. In the graphical view select **Zoom In** either from the context-menu (**right-click** in the background of the view) or from the **View** main menu, or click the -button in the **Toolbar**. The cursor's shape switches to a magnifying glass.
2. Take that cursor and click with the left mouse button into the view's background. The area around the cursor will be enlarged and centered.
or
Take that cursor, click with the left mouse button into the view's background and keep the mouse button pressed while dragging a rectangle to the lower right-hand-corner of the area you want to enlarge. The content of the rectangle will be enlarged.
3. Use the arrow keys from your keyboard to navigate left, right, up or down, or use the scroll bars on the left and bottom of the graphical window.

Alternatively:

- Use the “+” -key on your keyboard to enlarge the view.

Zoom Out

1. In the graphical view select **Zoom Out** either from the context-menu (**right-click** in the background of the view) or from the **View** main menu, or click the -button in the **Toolbar**. The cursor's shape switches to a magnifying glass.
2. Take that cursor and click with the left mouse button into the view's background. The area around the cursor will be reduced and centered.

Alternatively:

- Use the “-”-key from your keyboard to reduce the view.

Zoom 100%

- In the graphical view select **Zoom 100%** either from the context-menu (**right-click** in the background of the view) or from the **View** main menu, or click the -button in the **Toolbar**. The view will be zoomed to the extent needed for fitting all points and baselines as well as kinematic chains exactly into the graphical window.

Alternatively:

- Press <Home> on the keyboard to zoom to complete extent including kinematic chains.
- Press <Ctrl><Home> on the keyboard to zoom to the extents of points only.

Tip:

- Use the arrow keys from your keyboard to navigate left, right, up or down.

Points and Observations

New: Point, Setup, Observation (Adjustment)

This command allows you to create new Points, Setups or Observations.

An instrument **Setup** describes the type of Instrument that was used on a particular point and the centring / height errors. Setups of type **GPS**, **TPS**, **Azimuth** or **Level** can be created. In case of a **TPS** setup, the instrument height may be entered.

An **Observation** describes the type and the actual value(s) of the measurement, the standard deviation of the measurement and the centring / height errors of the target point.

Note:

- A Setup can only be created for existing points.
- An Observation between two points can only be created if an instrument Setup for the start / reference point is defined.

Select from the list below to learn more about the New command:

[New Point](#)

[New Setup](#)

[New Observation](#)

New Point (graphical views)

Allows you to graphically or manually add a new point to the database.

1. **Right-click** in the place within the background of the graphical window where you want to create a new point and select **New Point**.
2. Enter **Point Id**.
3. Optionally, adapt the parameters and/or the coordinates of the point.
4. Press **OK** to confirm or **Cancel** to abort the function.

Tip:

- Click **Apply** instead of OK if you want to manually enter a **series of points**.
- You can also create a new 2D point by **double-clicking** in the graphical window. The coordinate class *Estimated* and a Point Id (New Point 1, New Point 2...) will be assigned automatically.

Note:

- If the location of the new point is selected graphically using the mouse, the accuracy of the coordinates depends on the resolution of your computer's screen as well as on the size of the area being displayed (zoom status).

New Setup

Enables you to add a new Instrument Setup to a point. A Setup describes the type of Instrument that was used on a particular point. Thus, with GPS measurements a Setup will be where a GPS reference station was situated, with TPS measurements it will be where the instrument was situated and with Level measurements it will be where the level line started.

The centring / height errors may be entered. With TPS Setups the instrument height may be entered additionally.

1. **Right-click** on a point and select **New** and **Setup**.
2. From the list box **Type** choose one of the following:
 - GPS
 - TPS
 - Azimuth or
 - Level
3. In case of *TPS* enter the **Instrument Height**.
4. Modify the default **Centring** and **Height error** if necessary (not available for *Level* Setups).
Note: The default values may be set via Configuration **General Adjustment: Centring / Height**.
5. Press **OK** to confirm or **Cancel** to abort the function.

Note:

- A Setup can only be created for existing points. A Setup on the reference (start) point needs to be defined before a **new observation** from this point can be created.
- When a GPS Setup is selected, the instrument height may not be edited. This is due to the fact that the Adjustment does not obtain this information from LGO and a change in instrument height would require re-processing the GPS baselines.
- With a TPS Setup, all categories are available for editing. From manually created TPS setups **new TPS Setup applications** can be created in the **TPS-Proc** View.
- With an Azimuth Setup only the centring error may be edited. This is because there is no height information and only horizontal angles are of concern.
- With a Level Setup centering and height errors do not show up.

New Observation

Enables you to define a new observation between two existing points. New observations can only be defined in the **Adjustment** component.

1. **Right-click** on a point you want to use as the reference (start) point and select **New** and **Observation**.
2. **Click** on the target (end) point.
Note: If more than one type of setup exists for the selected start point, select the required observation type (e.g. GPS, TPS) from the list box.
3. Enter the observation values, the centring and height errors for the target point and the absolute plus relative estimates or the elements of the Qxx matrix.
Note: This page does **not** pop up if the **Data Creation Parameters: Observation** are set to **not Show details on creation** and if only one type of setup exists.
4. Press **OK** to confirm or **Cancel** to abort the function.

Note:

- Before you are able to create an observation between two existing points a **Setup** has to be defined for the reference (start) point.

Point Properties

Point Properties (graphical views)

This Property-Sheet enables you to display and/or modify the Point Properties.

1. In the Graphical-View right-click on a Point and select **Properties**.
 Alternatively: Double-click on a Point.
2. Use the tabs to switch between the following pages:
 - General
 - Stochastics
 - Setup
 - Thematical Data
 - Reliability (available only if the reliability has been previously calculated using the Adjustment component)
 - Mean (available only if more than one coordinate triplet of class *Measured* for a particular point exists)
 - Images (available only if at least one image is linked to the selected point)

Hidden Point functionality is only available for **GPS** measurements. **Hidden Point Properties** can only be displayed in the **View/ Edit** component or in the **Points View**:

 - Hidden Point (Position) (available only if the selected point is a Hidden Point)
 - Hidden Point (Height) (available only if the Hidden Point has height properties attached)
3. Make your changes
 Note: Only the fields with a white background may be edited at that particular instant.
4. Press **OK** to confirm or **Cancel** to abort the function.

Alternatively:

- Select a Point from the List-box  and press Edit selected Point  from the Toolbar.

Point Properties: Setup

Enables you to display/edit the instrument Setup of a point. A Setup describes the type of Instrument that was used on a particular point. Thus a Setup in the case of GPS will be where a GPS reference station was situated, in the case of terrestrial measurements it will be where the instrument was situated.

List box

Displays the **Date/Time** the setup was created, the **Type** of setup and the **Point Id**. If more than one Setup for a particular point exists, select from the list.

Setup type:

The setup type is displayed but can not be changed via Point Properties.

Instrument height:

If the setup type is TPS you may change the instrument height.

For **SmartWorx TPS setups** the following changes are applied when changing the Instrument height: If the instrument height was used in the field to calculate the height of the target points (**Set Orientation**, **Known Backsight**), then a change in the instrument height will automatically modify the heights of all connected target points by the same amount.

For the **Resection** methods and the methods **Multiple Backsights** and **Height Transfer** a change in the instrument height only modifies the height of the setup, but not the heights of the connected target points, unless the height of the setup was excluded from the setup calculation.

If the setup was not imported from SmartWorx raw data (but using GSI or TDS raw data import or if it was manually entered), then a change of the Instrument height will always modify all connected target points.

Centring error:

The centring error defines the predicted error that could have been made when centring the instrument (reference) over the point.

Height error:

The Height error defines the predicted error when measuring the instrument (reference) height.

Active:

You may deactivate the setup by clearing the Active check box. This will remove the setup and any associated observations from the adjustment computation.

Note:

- When a GPS setup is selected, the instrument height may not be edited. This is due to the fact that the Adjustment does not obtain this information from LGO and a change in instrument height would require a re-computation of the GPS baselines.
- With a TPS Setup, all categories are available for editing.
- With an Azimuth Setup only the centring error may be edited. This is because there is no height information and only horizontal angles are of concern.

Observation Properties

Observation Properties

This Property-Sheet enables you to display and/or modify the observation properties.

1. Right-click on an observation in the graphical view and select **Properties**.

One or more of the following Property-Pages will be displayed:

- GPS** - GPS Baseline information
- RTK Info** - Info on the used reference station network
- TPS** - TPS angle and distance measurements
- Azimuth** - Horizontal angle reading from theodolite or compass
- Level** - Height difference observation.

2. Make your changes

Note: Only the fields having a white background may be edited at the particular instant. Measurements are only editable if the observation has been manually entered.

Press **OK** to confirm or **Cancel** to abort the function.

Observation Properties: GPS

This Property-Page enables you to display/edit GPS observations.

List box

Displays the **Date/Time** the observation was created, the Reference Id (**From**) and the Rover Id (**To**). Select from the list, if more than one observation exists.

Active:

You may deactivate the observation by clearing the check box. This will ignore the observation for the adjustment computation.

Centring Error:

The centring error defines the predicted error that could have been made when centring the target (rover) over the point.

Hgt. Error:

The Height error defines the predicted error when measuring the target (rover) height.

Target Hgt:

The target height 0.000 is displayed and may not be edited. This is because the Adjustment does not obtain this information from LGO and a change in height would require a re-computation of the GPS baselines.

Baseline Vector:

The three baseline components **DX**, **DY**, and **DZ** of the observation data are displayed.

Note: The baseline components may only be edited if they have been created manually by using the **New Observation** command.

Use covariance matrix:

Use absolute plus relative estimates:

Allows to select the weighting scheme and edit the values. The weighting scheme used will depend on where the GPS observation data has come from. GPS observations from baseline processing, imported from other projects or imported as a SKI Baseline Vector ASCII file will use the covariance matrix by default. If instead of this you wish to use the absolute plus relative estimates, you may do so here. GPS Observations that have been created manually will most likely have an absolute and a relative estimate.

Observation Properties: RTK Info

This Property-page displays information on the real-time solution either computed with the differential correction data received from a single base reference station or by making use of a reference station network via a server. It is only displayed if the observation has been calculated using RTK.

List box

Displays the **Date/Time** when the observation was created, the Reference Id (**From**) and the Rover Id (**To**). Select from the list, if more than one observation exists.

Solution type:

There are two different solution types when RTK is used to compute a Rover position: **Network** and **Single baseline**.

A **Network** solution always includes the data from more than one reference station to compute corrections. The network consist of cells each of which is made up of at least three reference stations.

Network type:

Lists the kind of solution used within a reference station network. Available are **FKP**, **VRS**, **i-Max**, **Max** and **Nearest** as different kinds of a network solution.

If **Nearest** is shown this indicates that a single base solution has been computed from within the network.

RTK data format:

Lists the format of the transmitted correctional data. Available are:

- Leica 4G, - Leica
- RTCM v3
- CMR/CMR+
- RTCM 1,2 v2, - RTCM 9,2 v2, - RTCM 18,19 v2, - RTCM 20,21 v2
- SBAS

No. of ref. stations used:

If **Network Type Max** has been used then the number of reference stations that have been used to compute the corrections for a rover position are listed here.

Mountpoint:

A Mountpoint is an identification name from which real-time corrections are to be received.

Network operator:

Lists the operator of the used reference station network.

IP address/ Port:

To get access to an NTRIP server its IP address and Port have to be known. Both are listed here.

GPUID:

GPUID is a user authentication at a server via NMEA.

Rover inside of network:

Indicates whether the rover has been inside the network cell used for computing the correction data and which level of accuracy can be expected accordingly. If the rover is inside the cell the correction data can be interpolated best. If the rover is outside the cell the accuracy of the rover position is diminished.

Observation Properties: TPS

This Property-Page enables you to display/edit TPS observations.

List box

Displays the **Date/Time** the observation was created, the Setup Id (**From**) and the Target Id (**To**). Select from the list, if more than one observation exists.

Active:

You may deactivate the observation by clearing the check box. This will ignore the observation for the adjustment computation.

Centring Error:

The centring error defines the predicted error that could have been made when centring the target over the point.

Hgt. Error:

The Height error defines the predicted error when measuring the target height.

Target Hgt:

The target height is displayed and may be edited.

When changing the target height the height of the measured target coordinates will be shifted by the same amount.

TPS Observation:

The **direction**, **distance** and **zenith angle** are displayed and may be de-activated. De-activated observations are not used in an Adjustment calculation. The TPS observations (direction, distance and zenith angle) can only be edited for manually entered observations.

Standard deviations: The absolute and relative standard deviations can be edited for all TPS observations.

Reflector type:

The [reflector type](#) for the selected observation is displayed and may be changed. The **Add. Const.** for the selected reflector type is displayed next to the reflector type.

All default reflector types are available in the list and can be selected together with their additional constants.

- To add a new reflector type right-click into the **Reflector type** combo box and select **New**.

You can then enter a name and edit the additional constant for this reflector type. Changing the **Add. Const.** modifies the measured slope distance and the target point of the observation. Manually entered reflector types will be available for all observations of the selected project.
- To delete one or all user-defined reflector types right-click into the combo box and select **Delete** or **Delete All**.

Offsets:

The offsets of the selected observation (in **Length** and/ or **Cross** and/or **Height**) are displayed and may be changed. Changing the **Offsets** modifies the measured TPS observation(s) and the target point of the observation.

Note:

- Modifying **Target heights** and **Reflector types** is not allowed if the observation is used in a **Resection** or **Multiple Backsights** setup application. You can modify these items in the corresponding [Setup Properties: Observations](#) page, which enforces a re-calculation of the setup. Modifying **Offsets** is only allowed for Survey Observations.

- You can change the target height, the reflector type or the offsets simultaneously for more than one observation in the **Observations View** or in the **Survey Observations** report view in the **TPS-Proc** tabbed view.

Observation Properties: Azimuth

The **Setup** point and **Target** point are displayed. The **centring error** may be edited if required.

The observation data is displayed below this in the **Observations** box. The **Azimuth** together with its **standard deviation** is displayed and is available for editing if required.

Observation Properties: Level

This Property-Page enables you to display/edit height difference observations.

List box

Displays the **Date/Time** the observation was created, the Start Point Id (**From**) and the End Point Id (**To**) of the level line. Select from the list, if more than one observation exists.

Active:

You may deactivate the observation by clearing the check box. The observation will be ignored in the adjustment computation.



Height Difference Observation:

The **Height difference** together with its **Absolute Standard Deviation** and the **Distance levelled** are displayed. The values can only be edited for manually entered height difference observations.

Observations View

The Observation View gives you an overview on all observations (GPS, TPS, Level and Azimuth observations) contained in a project. It is available in the **Adjustment** and in the **View/ Edit** graphical views.

To invoke the Observation view:

- Right-click in the background of the  **Adjustment** or the  **View/ Edit** graphical view and select **View Observations...** from the background context menu or from the main menu.

The Observations view opens up in a stand-alone floating window. It's a two-pane view offering a tree view on the left-hand side and a corresponding report view on the right-hand side.

You may select from two different tree-views.

The **From** tab lists all points (GPS, TPS, Level and/ or Azimuth setups) in a project from which observations have been made to several target points. Depending on the kind of setups contained in the project the corresponding report view offers up to four different tabs (**GPS**, **TPS**, **Level** and/ or **Azimuth**) each listing the **observation properties** for each target point that has been measured from the selected setup.

The **To** tab lists all target points contained in a project. Depending on the kind of setups (GPS, TPS, Level or Azimuth) from which the target points have been measured the corresponding report view offers up to four different tabs (**GPS**, **TPS**, **Level** and/ or **Azimuth**) each listing the **observation properties** for each setup from which the selected target point has been measured.

Example:

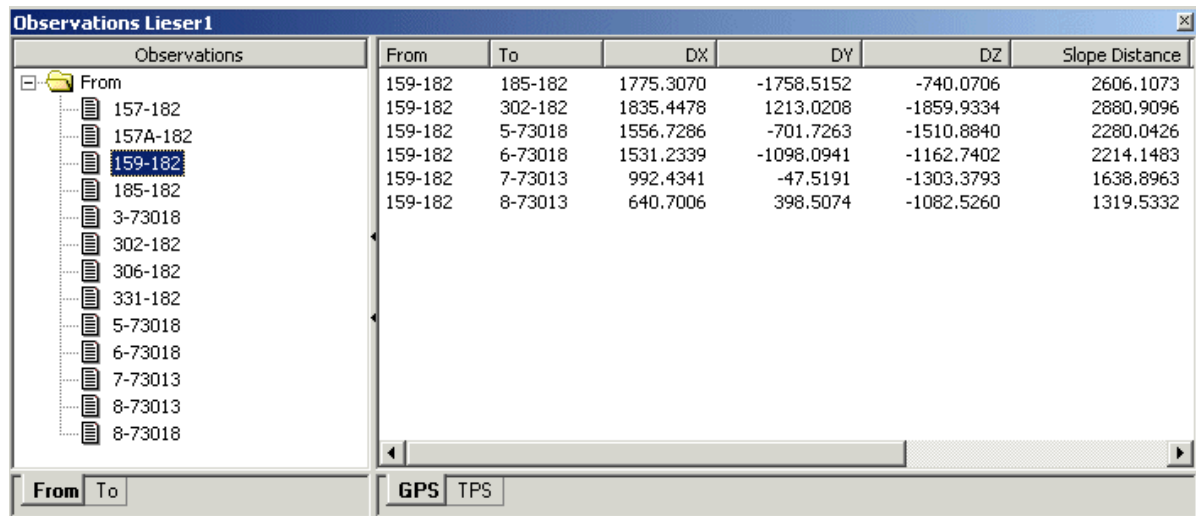

The screenshot shows a window titled "Observations Lieser1" with a tree view on the left and a data table on the right. The tree view shows a folder "From" containing several sub-items, with "159-182" selected. The data table has columns for "From", "To", "DX", "DY", "DZ", and "Slope Distance".

From	To	DX	DY	DZ	Slope Distance
159-182	185-182	1775.3070	-1758.5152	-740.0706	2606.1073
159-182	302-182	1835.4478	1213.0208	-1859.9334	2880.9096
159-182	5-73018	1556.7286	-701.7263	-1510.8840	2280.0426
159-182	6-73018	1531.2339	-1098.0941	-1162.7402	2214.1483
159-182	7-73013	992.4341	-47.5191	-1303.3793	1638.8963
159-182	8-73013	640.7006	398.5074	-1082.5260	1319.5332

The report views offer the following functionality:

- Select **Properties...** from the context menu to display the observation properties of the selected observation. For details see:

[Observation Properties: GPS](#)
[Observation Properties: TPS](#)
[Observation Properties: Level](#)
[Observation Properties: Azimuth](#)

Observation Properties: RTK Info

- Select **Zoom to Observation** from the context menu to zoom the graphical view to the extents of the selected observation(s).
- To delete one or more observations select the observations to be deleted and select **Delete** from the context menu.
- In the **TPS** observation tab you can modify the target height, the reflector type, the offsets and the geometrical or the atmospheric ppm simultaneously for more than one observation. Select the observations and choose **Edit Target Height...** or **Edit Reflector Type...** or **Edit Offsets...** or **Edit geometrical PPM...** or **Edit atmospheric PPM...** from the context menu.

For **single** observations the target height, the reflector type or the offsets may also be modified via the in-line edit functionality. Select the observation and right-click onto the item to be changed in its respective column. From the context menu select **Modify...** Alternatively, double-click slowly onto the item to be changed to open the in-line edit field.

Modifying the target heights updates the measured point coordinates. Modifying reflector types updates the slope distances and the measured point coordinates. Modifying offsets updates the measured TPS observation(s) and the measured point coordinates. [Modifying the geometrical ppm](#) updates the horizontal distances and the measured point coordinates. [Modifying the atmospheric ppm](#) updates the original slope distance and the measured point coordinates.

Note: Modifying target heights, reflector types or geometrical ppm values is not allowed if the observation is used in a 'Resection' or 'Multiple Backsights' setup application. You can modify target heights or reflector types in the corresponding [Setup Properties: Observations](#) page, which enforces a re-calculation of the setup. Modifying offsets is only allowed for Survey Observations.

- In the **TPS** and in the **GPS** observation tab you can modify the target/ rover point codes for one or more points simultaneously.

The thematical code of a single target/ rover point may be modified via the in-line edit functionality. Select the observation and right-click onto **Code** column. From the context menu select **Modify...** Alternatively, double-click slowly onto the code to be changed to open the in-line edit field. All point codes that are available in the Codelist of the active project will be offered for selection.

To modify the thematical code for **more than one** target/ rover point at once select the set of points to be modified, right-click into the selection and select **Edit Target Point Code.../ Edit Rover Point Code...** from the context menu. Again all point codes that are available in the Codelist of the active project will be offered for selection.

Note: Attribute values which might have been defined for the selected Target/ Rover point(s) are removed when changing the code. They would have to be re-defined for each target/ rover point in the [Point Properties: Thematical data](#) dialog page if desired.

Note:

- When you select a setup/ target point in one of the tree views the point will simultaneously be selected in the Select point combo box of the **Scroll&Query** toolbar.

Activate / De-activate Points, Setups and Observations (graphical views)

Allows you to activate or de-activate points, setups and/or observations. If a point, a setup or an observation is deactivated it is still visible on the screen and stored in the database.

See [Graphical Settings: Color](#) to set the color for de-activated points and observations.

Activate:

- Highlight a de-activated point/ setup or observation and select **Activate** from the context menu or from the main menu.
or
Select a series of de-activated points/ setups or observations and select **Activate** and then either **Points/ Setups** or **Observations**.

De-activate:

- Highlight a point/ setup or observation and select **De-activate** from the context menu or from the main menu.
or
Select a series of points/ setups or observations and select **De-activate** and then either **Points/ Setups** or **Observations**.

Note:

- If more than one **setup** or **observation** exists for a point or between two points then the single setups and observations may be activated or deactivated via the corresponding property pages.
- Deactivated points, setups or observations will not be used in the optional Adjustment component.
- Observations connected to deactivated **points** will not be displayed.
- Deactivated **points** can be ignored in [ASCII Export](#).

Delete: Point, Setup, Observation

You may delete Points, Triplets, Setups and/or Observations from the database.

Select from the list below to learn more about the Delete command:

[Delete Points/ Triplets](#)

[Delete Setups](#)

[Delete Observations](#)

Delete Points/ Triplets (graphical views)

Enables you to delete all or individual coordinate class triplets of a Point.

To delete a point:

1. Highlight a point and select **Delete** and then **Point** from the context-menu or from the **View/ Edit** or **Adjustment** main menu.
2. Press **Yes** to confirm or **No** to exit without deleting.

Note:

- If you delete a Point, all coordinate triplets and all associated data including raw data will be deleted permanently from the database.

To delete point triplets:

To delete a particular coordinate class (coordinate triplet) of one or a series of points, highlight the point(s) to be deleted, and select **Delete** and then **Triples** from the context menu or the **View/ Edit** or **Adjustment** main menu and select an individual class from the list.

Note:

- If you delete the only coordinate triplet that exists for a point, the entire point will be deleted from the database.
- If you delete the *Averaged* point triplet, **all** *Measured* triplets will be deleted as well.

Tip:

- If you select a series of Points all of them can be deleted at once. To select all points you may also press Ctrl-A on the keyboard.

Delete Setups

Enables you to delete Point Setups in the **View/ Edit** and in the **Adjustment** component.

1. Highlight a point, select **Delete** and then **Setup** from the context menu or from the **View/Edit** or **Adjustment** main menu.

Note: If more than one Setup exists, you will be prompted.

2. Press **Yes** to confirm or **No** to exit without deleting.

Tip:

- If you select a series of Setups (points) all of them can be deleted at once.
- If a Setup is deleted in **View/Edit** or in the **Adjustment** view, all observations associated with that setup will be deleted also.
- Setup Applications stored in the **TPS-Proc** view can be deleted via the context menu of the TPS-Proc view. The **observations** included in the **Setup Application to be deleted will be kept**.

Delete Observations

Enables you to delete observations from the database. An observation may be a processed baseline or a manually entered terrestrial observation from the Adjustment component.

1. Highlight an observation and select **Delete** and then **Observation** from the context menu or from the **View/Edit** or **Adjustment** main menu.

Note: If more than one Observation exists, you will be prompted.

2. Press **Yes** to confirm or **No** to exit without deleting.

Tip/Note:

- GPS raw data are NOT deleted if you delete a baseline.
- If you select a series observations all of them can be deleted at once.
- If you want to delete an observation (baseline) that consists of more than one track, a dialog box appears allowing you to select individual tracks.

Pre-analysis

The Pre-analysis computation is used for checking the network prior to the adjustment. Quality control checks as well as mathematical checks on the data are carried out.

- Right-click and select Pre-analysis from the context-menu. This functionality can only be selected, if under **Graphical Settings – View** either GPS or TPS or Azimuth or Level or a combination of these four observation types has been ticked. De-activated observations do not take part in the Pre-analysis computation either.

The computation is performed using the MOVE3 Adjustment kernel licensed to LEICA Geosystems AG by Grontmij Geo Informatie, bv, Rosendaal, The Netherlands. For detailed information refer to: www.move3.com.

The results of the Pre-analysis computation are contained in the **Pre-analysis Report**.

Compute Network

The network computation performs either the adjustment computation or the design simulation, depending on the parameters set under [General Parameters: Control](#).

- Right-click and select **Compute** from the context-menu or click the  toolbar button. In both cases **Compute** can only be selected, if under [Graphical Settings – View](#) either GPS or TPS or Azimuth or Level or a combination of these observation types has been ticked. De-activated observations do not take part in the Adjustment computation either.

The computation is performed using the MOVE3 Adjustment kernel licensed to LEICA Geosystems AG by Grontmij Geo Informatie, bv, Rosendaal, The Netherlands. For detailed information refer to: www.move3.com.

The results of the network computation are contained in the [Network Report](#).

Compute Loops

Of all the possible loops you might determine in a network some are redundant because they comprise of two or more smaller loops. The Loops functionality is used for the automatic computation of network loops and loop misclosures. It detects the complete set of the shortest loops, i.e. any other loop can be constituted from a combination of the loops found. The shortest loop is the one with the minimum number of sides. The calculated closing errors are tested using the **W-Test**. Note that the routine does not use approximate and known coordinates, and does not necessarily use all observations.

- Right-click in the **Adjustment** View and select **Compute Loops** from the context-menu. Alternatively, select **Compute Loops** from the **Adjustment** main menu.

The computation is performed using the MOVE3 Adjustment kernel licensed to LEICA Geosystems AG by Grontmij Geo Informatie, bv, Rosendaal, The Netherlands. For detailed information refer to: www.move3.com.

The computation results are stored in the **Loops Report** and can be viewed via the **Results - Loops** entry in the **Adjustment** main menu. The loops and closing errors are listed per loop type as described below.

The following types of loops can be detected in a network:

1. GPS baseline loops

In a GPS baseline loop the three sums of all coordinate differences DX, DY and DZ yield closing errors in X, Y and Z.

2. Direction & distance loops

In a direction & distance loop the sum of the angles in the loop should be a multiple of 200 gon or 180 deg. The remainder is the angular closing error. The closing errors in X (local Easting) and Y (local Northing) are computed in a local XY system, with the positive Y axis parallel to the first side of the loop, and the X axis perpendicular to it.

Note: If the two directions of one angle in a loop are not from the same setup, the angular closing error cannot be computed. The closing errors in X and Y however can still be computed by starting at the point with the missing angle. If two or more angles are missing no closing errors can be computed.

3. Zenith angle & distance loops

In a zenith angle & distance loop the sum of the derived trigonometric height differences also yields a closing error in height.

4. Height difference loops

In a height difference loop the sum of all height differences equals the closing error in height.

Loops formed with combinations of these types are not considered.

Instrument heights (loop types 3 and 4), scale factors (loop types 2 and 4) and vertical refraction coefficients (loop types 2 and 4) are accounted for.

According to the **Dimension** set under **General Adjustment Parameters: Control** the computation will be based upon 3D, 2D or 1D measurements.

- If the Dimension is set to **3D** then **all types of loops** will be considered in the computation.
- If the Dimension is set to **2D** then only **types 1 and 2** will be considered in the computation.
- If the Dimension is set to **1D** then only **types 3 and 4** will be considered in the computation.

Note:

- The Compute Loops functionality is an automated process. GPS baseline loops may also be computed manually in **View/ Edit** via the **Loop Misclosure** functionality. The Compute Loops functionality as integrated into the Adjustment component is always applied to the unadjusted network and may be used independent of the **protected Adjustment** component.

Graphical Settings

Graphical Settings (Adjustment)

The Graphical Settings Property-Sheet enables you to configure the graphical view. You may configure which items to display, select the colors of graphical elements and the font for text items.

1. From the context menu (right-click) or the **View** main menu select **Graphical Settings...**
2. In the Property-Sheet use the tabs to switch between the following pages:

View
Accuracy
Grid
Color
Font

3. Make your changes or press the **Default** button to apply the default values to the parameters of a page.
4. Press **OK** to confirm or **Cancel** to abort the function.

Graphical Settings: View

This Property-Page enables you to define which graphical elements shall be displayed.

General:

Grid

Check to display a coordinate grid.

Note: To Configure the grid see: [Grid](#).

North Arrow

Check to display an arrow in the upper right corner pointing to the north.

Scale Bar

Check to display a Scale Bar in the lower left corner of the screen. The Scale bar will alter its size and description to suit the scale at which you are zoomed in at. Additionally, the scale bar will appear on any printout that you make, when activated.

Legend

Check to display a legend listing the point symbols of all possible point classes.

Coordinate Tracking

Check to display the mouse coordinates in the Status Line.

CAD files

Check to display the CAD files which have been attached to the project and have been activated in the [Project Properties: CAD files](#) dialog page.

Data:

Point Ids

Check to display the Point Identifications

Note: To configure the font see: [Font](#). To configure the color see: [Color](#).

Height Value

Check to display the Height Values. If the view is configured to display *local grid* coordinates either the *orthometric* or the *ellipsoidal* height value is displayed **depending on** the choice you made in the [Tools-Options: Units/ Display](#) dialog page.

Note: Only if the requested height mode is available will a height value be displayed. And height values are only displayed if the font for **Point Id** is a  True Type font. To configure the font see: [Font](#).

Thematical Codes

Check to display the Thematical Code

Note: Thematical Code values are only displayed if the font for **Point Id** is a  True Type font. To configure the font see: [Font](#).

Abs. Error Ellipses

Check to display the point accuracy indicators. The point accuracy is represented by the corresponding error ellipse (which represents the two-dimensional 1-sigma confidence region of the point) and the standard deviation of the height (1-sigma confidence region).

Note: To configure scale and color of the accuracy indicators see: [Accuracy](#).

Rel. Error Ellipses

Check to display the observation accuracy indicators. The observation accuracy is represented by the corresponding error ellipse (which represents the two-dimensional 1-sigma confidence region of the observation) and the standard deviation of the height difference(1-sigma confidence region).

Reliability

Check to display the point reliability indicators. The point reliability is represented by the corresponding rectangle (which represents the two-dimensional reliability of the point coordinates) and a vertical bar (which represents reliability of the height)

GPS Observations

Check to display the GPS baseline vectors

Note: To configure the color of the baseline vectors see: [Color](#).

TPS Observations

Check to display the TPS (direction and distance) measurements

Note: To configure the color of the TPS observations see: [Color](#).

Azimuth Observations

Check to display the Azimuth measurements

Note: To configure the color of the Azimuth observations see: [Color](#).

Level Observations

Check to display the height difference observations

Note: To configure the color of the Level observations see: [Color](#).

Avg. Limit exceeded

Check to display a hatched rectangle for points containing measured coordinate triplets that exceed the averaging limit.

Note:

- Those observation types (GPS, TPS, Azimuth and Level) which are switched off will also not be used in the adjustment.

Graphical Settings: Accuracy

This Property-Page enables you to set the scale and color of the point accuracy indicators.

The point accuracy is represented by the corresponding error ellipse (which represents the two-dimensional 1-sigma confidence region of the point) and the standard deviation of the height (1-sigma confidence region).

Abs. Error Ellipses

Enter a value between 0.00001 – 1 to set the scale of the point accuracy indicators.
Select a color from the combo box.

Rel. Error Ellipses

Enter a value between 0.00001 – 1 to set the scale of the observation accuracy indicators.
Select a color from the combo box.

Reliability

Enter a value between 0.00001 – 1 to set the scale of the point reliability accuracy indicators.
Select a color from the combo box.

Graphical Settings: Grid

This Property-Page enables you to set the interval, style and color of the coordinate grid.

Type

Select *Automatic*. Depending on the zoom status of the view a suitable grid spacing will be chosen automatically.

Select *Geodetic* and enter the grid spacing in degrees.

Select *Grid* and enter the grid spacing in linear units.

Grid style

Select between *Cross* and *Full* to display cross symbols or full gridlines.

Line style

Select a line style from the list if full gridlines are displayed.

Color

Select a color from the combo box.

Note:

- For the **Level Lines view**, for the **TPS-Proc Traverse view**, for the **Cogo Map view** and for the **Surfaces 2D view** only the **Grid Type Automatic** is available.

Graphical Settings: Color

This Property-Page enables you to set the color of the database items.

- In the **Color** column double-click onto the corresponding color field and select a color from the in-line edit combo box.

Selected Observations

Select a color from the in-line edit combo box to set the color of selected point symbols and observations.

De-activated Observations

Select a color from the in-line edit combo box to set the color for de-activated point symbols and observations.

Point Symbols

Select a color from the in-line edit combo box to set the color of the point symbols.

GPS Observations

Select a color from the in-line edit combo box to set the color of the GPS baselines.

TPS Observations

Select a color from the in-line edit combo box to set the color of the TPS measurements.

Setup/ Traverse Observations

Select a color from the in-line edit combo box to set the color of the Setup and Traverse measurements.

Azimuth Observations

Select a color from the in-line edit combo box to set the color of the azimuth measurements.

Level Observations

Select a color from the in-line edit combo box to set the color of the direct leveling measurements.

Outlier

Select a color from the in-line edit combo box to set the color of the biggest outlier.

Background

Select a color from the in-line edit combo box to set the color of the view's background.

Graphical Settings: Font

This Property-Page enables you to set the Font for **Point Ids**, **Legend** and **Grid** labels.

- Click on the corresponding radio button to open the standard Windows font dialog. Select font, size, color etc. Press **OK** to confirm or **Cancel** to abort the function.

Note:

- The font for Point Id is also valid for displaying the Height and Thematical Code values. Height and Thematical Code values are only displayed if you select a  True Type font.
- For points resulting from **Cogo Calculations** but not being stored in the project, yet, a font may be selected separately.

Tip:

- Refer to Windows Help on how to use fonts.

Using the Design capabilities

In order to check a network design and calculate a priori values without making any actual observations, proceed as follows:

1. Create your Points using the [New Point](#) command.
2. Create the Setups at those points using the [New Setup](#) command.
3. Create the Observations using the [New Observation](#) command.
4. From the Context-Menu (right-click) select **Configuration** and **General Parameters**. In the [Control](#) page select **Design – selection based on theoretical observations**.
5. [Compute](#) the network.
6. The results will be presented in the [Network Report](#).

Note on adjusting GPS and Terrestrial measurements

When you want to adjust GPS baselines together with Terrestrial data, all the measurements have to be referred to the same local ellipsoidal system. The terrestrial measurements will already be in this local system but the GPS baselines will be in WGS84.

The following steps must be taken in order to achieve meaningful results when adjusting Terrestrial data with GPS data:

1. Use existing GPS baseline data from the current project, copy baselines from other projects or import via **SKI ASCII** file.
2. Import the Terrestrial data via **Raw data import** or enter the measurements manually using the **New** command from the Context-menu.
3. In general, at least three points in the network must be fixed. This can be absolutely fixed or weighted fixed according to the standard deviations of the point. Right-click on a point, select **Properties** and change the Point Class to *Control*. Fixed points are set as weighted or not under Configuration, **General Parameters: Known Station**.
4. Under Configuration, **General Parameters: Coordinate System** change the Coordinate System to *Local Geodetic* and enable the computation of rotation and scale parameters.
5. Check if **General Parameters: Control** are set correctly.
6. **Compute** the Network.

Note on heights:

- You may enter either local ellipsoidal heights or orthometric heights for the fixed points. If orthometric heights are given, the geoid-ellipsoid separations are largely absorbed by the estimated transformation parameters and the adjusted coordinates will have orthometric heights, if this was configured in the **General Parameters: Coordinate System** page. This approach to obtain orthometric heights directly works well when the geoid-ellipsoid separation changes only slowly and consistently in the network area.

Configuration

Configuration Adjustment

The Configuration menu contains settings that configure set the way in which the adjustment is computed and the way the results of that adjustment is presented.

Select from the list below to learn more about Configuration:

[General Parameters](#)

[Terrestrial Parameters](#)

[Data Creation](#)

General Adjustment Parameters

General Adjustment Parameters

This Property-Sheet enables you to define the General Adjustment Parameters:

1. From the context menu (right-click) select **Configuration** and **General Parameters**.
2. In the Property-Sheet use the tabs to switch between the following pages:

- Control
- Standard Dev.
- Centring / Height
- Known Station
- Test Criteria
- Coordinate System

3. Make your changes or press the **Default** button to apply the default values to the parameters of a page.
4. Press **OK** to confirm or **Cancel** to abort the function.

General Parameters: Control

The Control page enables you to define parameters that affect the adjustment mode, number of iterations and iteration criteria.

Mode:

Design - enables you to design a network and simulate an adjustment based on theoretical observations to obtain predicted precisions of the coordinates. Actual observation data is not used. The accuracy information that is applied to the observations is that set in [Standard Deviation](#).

Adjust - will perform an adjustment computation using the accuracy information imported from the field observations, i.e. real observations, if this information is available.

Max. no. of iterations:

This sets the maximum number of iterations or runs of calculation that will be performed in order to try to reach the iteration criteria (see below). It prevents the computation going into an endless loop if there are problem observations and the iteration criteria cannot be met. With GPS observations, 1 iteration is normally sufficient to meet the iteration criteria. The Adjustment component will automatically finish the computation if (for example), the iteration criteria are met in the first iteration and 3 iterations have been set.

Iteration criteria:

The iteration criteria is the size of the correction to the coordinates which must be reached before iterations will stop (subject to Max no. of iterations).

Dimension:

This setting allows you to choose between performing a 1D-, 2D- or 3D Adjustment. Depending on the chosen dimension the following types of data will be adjusted:

3D:

3D data will be adjusted. Where only 2D or 1D data is available (e.g. Level observations within a GPS network), the 2D and 1D observations will be adjusted as well.

2D:

If your network contains GPS baselines these will always be adjusted in 3D even if the dimension is set to 2D.

TPS slope distances & zenith angles will be reduced to horizontal distances. Slope distances without zenith angles are ignored in the adjustment.

Level height differences are not included in a 2D solution.

1D:

GPS baselines are not included in a 1D adjustment.

TPS slope distances & zenith angles will be reduced to trigonometric height differences. TPS directions are ignored.

In addition, the **Dimension** setting affects the [Loops computation](#). The Loops computation will include the same observations as specified for the adjustment (3D, 2D or 1D).

[Overview table:](#)

	GPS	TPS	Level
3D	DX, DY, DZ	Direction & Zenith angle & slope dist.	height diff.
2D	DX, DY, DZ	Direction & horizontal dist.	-----

1D	-----	Trig. height diff.	height diff.
----	-------	--------------------	--------------

Use Sets of Angles results:

When calculating a network adjustment all **active** observations will be used. Check this option, if you wish to use **only the reduced observations** for all **Sets of Angles** applications stored in the project. The single observations contained in the Sets of Angles will then not be used. All observations stored with the same setup, but not being used within the Sets of Angles application will be skipped as well. The standard deviations for the reduced observations will be taken from the Sets of Angles calculation (i.e. the mean error of the averaged observations).

Include turning points of level lines:

For processed level lines the total height difference of the line is used as an observation. Check this option, if you wish to include the turning points of the level line and feed the subsequent height differences into the adjustment computation instead. This may be required if adjusted heights are needed for any of the turning points or if intermediate sights shall be adjusted as well.

Note: Due to the high number of observations with small redundancy the statistical test figures may become less informative if this option is selected.

General Parameters: Standard Deviation

The Standard Deviation page enables you to define the default accuracy applied to any new observation that is manually created or that shall be applied as the default to all observations during the adjustment computation.

Basically you can define the accuracy of an observation by defining the accuracy of the measurement between the two points. Additionally, if required, define the accuracy with which the two end points of the measurement were located using [Centring / Height](#).

Each type of measurement supported by the Adjustment component is given together with the currently defined default standard deviation. The given standard deviations may be amended if required. The standard deviations are defined in terms of an **Absolute** accuracy and a **Relative** accuracy. For example, with a GPS baseline an **absolute** value of 0.01m followed by a **relative** value of 1 ppm (part per million) renders a standard deviation of 10mm (absolute) plus $1 \times 5\text{mm} = 15\text{mm}$ when applied to a 5 km baseline.

Note: Scale factor corrections for TPS distance observations may be defined under [Scale factor correction](#).

Compute using:

- **individual settings for all observations** - uses the individual accuracy that was assigned to the observation during creation.
- **the default settings to all observations** - uses the default accuracy defined above for all observations.

When adjusting GPS observations (baselines) the following two options are available additionally:

- **the default settings to GPS observations only** - uses the default accuracy for GPS observations from above and the individual accuracy for terrestrial observations.
- **the default settings to terrestrial observations only** - uses the default accuracy for terrestrial observations and the individual accuracy for GPS observations.

General Parameters: Centring / Height

The Centring / Height page enables you to define the default accuracy applied to any new Setup or Observation that is manually created or that shall be applied as the default to all observations during the adjustment computation.

The Centring and Height accuracy of the two end points (Reference/Setup and the Rover/Target) may be defined in addition to the [Standard Deviation](#) of a measurement.

The **Centring** error defines the predicted error that could have been made when centring the instrument/target over the point. The **Height** error defines the predicted error when measuring the height of the instrument/target above the point.

These values may be assigned to observations or setups as they enter a network by setting the appropriate Data Creation Parameters of [Observations](#) or [Setups](#).

Compute using:

ignore centring and height errors - will set all centring and height errors to zero (i.e. there will not be any centring and height error).

individual settings for all observations - uses the centring and height error that was applied when the observation was created.

the default settings to all observations - uses the default centring and height error as defined above.

General Parameters: Known Station

This page enables you to define how to treat Known Stations (control points) in the adjustment.

Treat control points as absolutely fixed (Constrained Adjustment)

When the fixed stations are treated as absolutely fixed, they may not move in any direction and the standard deviations of the fixed stations will be ignored.

Treat control points as weighted fixed according to standard deviations (Weighted Constrained Adjustment)

When the fixed stations are treated as relatively fixed, you may enter the standard deviations of the fixed stations and this will be taken into account in the adjustment computation.

General Parameters: Test Criteria

This page enables you to set the Test Criteria for the adjustment.

Alpha (%)

This is the probability of rejecting a good observation. 5% is selected as default as this is seen as a good compromise. Setting the Alpha value too low may result in a bad observation being accepted.

1-Beta (%)

This can be defined as the power of the test or the probability of accepting a bad observation. 80% is selected by default as this is seen as a good compromise. Setting the Beta value too high may result in good observations being rejected.

Note: The Alpha and Beta settings are subjective and should be made by the experienced surveyor who carried out the field work. If in doubt as to what Alpha and Beta should be set to, accept the default values suggested.

Sigma a priori (GPS)

This value is to compensate for optimistic GPS observations. Quite often, observations coming from GPS post-processing programs are overly optimistic in their accuracy information. This in itself does not matter when adjusting GPS observations alone but is important when combining GPS and terrestrial observations.

Sigma a posteriori

This is a global value that adjusts for the uncertainty of the a priori value. It will affect the estimated precision of the adjusted coordinates. You may, if required only apply the sigma a posteriori if the adjusted coordinates fail the so-called F-test. The F-test is a test that is applied to the sigma a priori and sigma a posteriori. If they are statistically different it indicates that the stochastic values awarded to the observations were incorrect (assuming outliers have been removed). Applying the sigma a posteriori would then compensate for this problem.

General Parameters: Coordinate System

This page enables you to define parameters that affect the Coordinate System in which the adjusted coordinates are presented i.e. to which coordinate system the known (fixed) stations refer to.

GPS measurements are always made on the WGS84 ellipsoid. However, if required you can output results in any local ellipsoidal system. In this case the Adjustment component needs to be able to transform the GPS baselines during the adjustment. The required transformation parameters may be known to you already or you may wish to compute them.

If you are combining terrestrial observations with GPS observations your terrestrial observations will always be in a local ellipsoidal system while your GPS observations will be in WGS84 system.

You can also adjust terrestrial observations in a local grid system. The adjusted coordinates will then also refer to this local grid.

Coordinate system:

Choose **WGS84** if you want to adjust your observations to the WGS84-coordinates of the Known (fixed) Stations.

Choose **Local Geodetic** if you have a local coordinate system attached to your project and you want to adjust the observations to the local coordinates of the Known (fixed) Stations.

Note: The transformation used in your local coordinate system has to be either a **Classical 3D** or **None** for this option to become active.

See [Project Management](#) on how to attach a local coordinate system to a project.

Choose **Local Grid (Terrestrial only)** if you want to adjust pure terrestrial observations in a local grid system. In this case no information on the local ellipsoid is necessary. **Note:** Only terrestrial observations are adjusted if this option is selected. If there are GPS observations among your terrestrial observations the GPS observations will be ignored. Choose **Local Geodetic** if you want to compute a **combined** adjustment.

Height mode:

Choose **Ellipsoidal** if you want to adjust your observations to the ellipsoidal height of the Known (fixed) Stations.

Note: If the ellipsoidal height of a Known Point is not defined a Geoid separation of zero will be assumed.

Choose **Orthometric** if you want to adjust your observations to the orthometric height of the Known (fixed) Stations.

Note: If the orthometric height of a Known Point is not defined a Geoid separation of zero will be assumed.

The adjusted coordinates will have ellipsoidal or orthometric heights depending on the selected height mode.

Note: If orthometric heights are available for the Known Points and a geoid model is included in the coordinate system attached to the project then proceed as follows:

1. [Calculate geoid separations](#) for your project.
2. Run the adjustment with setting the height mode to **ellipsoidal**.

After the adjustment the geoid separations will be applied again to get the orthometric heights of the adjusted coordinates.

Transformation:

In order for the transformation to take place, there are four parameters that are required - three rotations about each axis and a scale factor. These are the parameters that are required when transforming observations.

Note: For transformation of coordinates or points, up to 7 parameters may be required and therefore the Datum/Map component should be used.

If you know the transformation parameters, enter them by double clicking on each parameter and entering the **Value**. Double click on the **Compute** parameter and set it to be inactive by selecting **No**.

If you do not know the transformation parameters, double click on each **Compute** parameter in turn and set it to be computed by selecting **Yes**.

Note:

- In order to compute transformation parameters you should hold at least three of your points fixed. Failure to do so will create error messages when the network computation is carried out. It is also important to note that the computed transformation parameters are only valid for transforming GPS baselines - they are not to be used for transforming coordinates.

Terrestrial Adjustment Parameters

Terrestrial Adjustment Parameters

This Property-Sheet enables you to set certain correction factors which may be used in conjunction with terrestrial observations:

1. From the context menu (right-click) select **Configuration** and **Terrestrial Parameters**.
2. In the Property-Sheet use the tabs to switch between the following pages:
 - Vertical refraction coefficient
 - Azimuth offset
 - Scale factor correction
3. Make your changes or press the **Default** button to apply the default values to the parameters of a page.
4. Press **OK** to confirm or **Cancel** to abort the function

Terrestrial Parameters: Vertical refraction coefficient

This Property-Page enables you to define the vertical refraction coefficient, which accounts for the influence of refraction on zenith angles:

Default value:

The default value is 0.13, which is a typical value that may be changed if required.

Note: As the Vertical refraction coefficient will apply to all vertical angle measurements in the Network, it should only be used in networks that cover relatively small areas.

Select **Apply to zenith / vertical angles** if you want to apply the above set default value to all vertical angles.

Select **Do not apply to zenith / vertical angles** if you wish to apply the corrections to the vertical angles individually before entering the data into the Adjustment.

Alternatively select **Estimate** if you wish to estimate the vertical refraction coefficient. This will mainly be used where there are many vertical angle measurements and a good estimate can be obtained.

Terrestrial Parameters: Azimuth offset

This Property-Page enables you to define the azimuth offset, which accounts for systematic biases in the azimuth measurements.

Default value:

Enter an offset if required.

Note: It is a constant offset for (E.g.) magnetic azimuths to geodetic azimuths. The Adjustment component always takes azimuth readings as geodetic.

Select **Apply to azimuths** if you want to apply the above set default value to all vertical angles.

Select **Do not apply to azimuths** if you wish to apply the offset to the azimuths individually before entering the data into the Adjustment.

Alternatively select **Estimate** if you wish to estimate the offset. This will mainly be used where there are many azimuth measurements and a good estimate can be obtained.

Terrestrial Parameters: Scale factor correction

This Property-Page enables you to define the scale factor, which will be applied to distance measurements and is an additional factor used to correct for (E.g.) atmospheric conditions.

Default value:

Enter a value in ppm (part per million).

Select **Apply to distances** if you want to apply the above default value to all distances.

Select **Do not apply to distances** if you wish to apply the scale factor to the distances individually before entering the data into the Adjustment.

Alternatively select **Estimate** if you wish to estimate the scale factor. This will mainly be used where there are many distance measurements and a good estimate can be obtained.

Data Creation Parameters of Adjustment

Data Creation Parameters of Adjustment

This Property-Sheet enables you to define the Data Creation Parameters. These parameters are used when you are manually entering Observation or Setup data:

1. From the context menu (right-click) or the **Adjustment** main menu select **Configuration** and **Data Creation**.
2. In the Property-Sheet use the tabs to switch between the following pages:
 - Observation
 - Setup
3. Make your changes or press the **Default** button to apply the default values to the parameters of a page.
4. Press **OK** to confirm or **Cancel** to abort the function.

Data Creation: Observation

This Property-Page enables you to set parameters that will be used when you are creating new Observations manually.

Interface:

Multiple 'To' station selection will enable you to select multiple target stations from the same reference/setup.

Show details on creation allows you to display the observation details as the observations are created.

Stochastic defaults at target / rover:

Select between standard deviation and centring and height precisions or standard deviation only. The default values will be applied to new observations as set in the General Adjustment Parameters [Centring / Height](#) and [Standard Deviation](#).

Note: At least the standard deviations will always be applied since there is no point in trying to adjust a network of fixed points!

Data Creation: Setup

This Property-Page enables you to set parameters that will be used when you are creating new Setups manually.

Stochastic defaults at setup / reference:

Select between centring and height precisions or none. If you select centring and height precisions, the default values will be applied to new setups as set in the General Adjustment Parameters [Centring / Height](#)

Results

Results

The Results menu provides you with the means to display specific reports on your results.

- From the background context menu (right-click) select **Results** and then one of the following:

Pre-analysis

To display the [Pre-analysis report](#).

Network

To display the [Network report](#).

Loops

To display the [Loops report](#).

Delete Stored Values

On activating this functionality, all adjusted triplets in the selected project will be deleted and the menu item itself will simultaneously be de-activated. **Delete Stored Values** is active when one or more points in the selected project contain an adjusted triplet. The same functionality can be achieved by selecting all points and activating the main menu item [Edit-Delete-Triplets-Adjusted](#).

Adjustment Pre-analysis Report

To get an overview on the pre-analysis that has been performed for the adjustment of your network you may invoke the **Adjustment Pre-Analysis** Report.

- From the **Adjustment** main menu select **Results** and then **Pre-analysis** to get a report on the pre-analysis that has been performed for your network adjustment.
Alternatively: Right-click and select **Results** and then **Pre-analysis** from the background context menu.

The report opens in a stand-alone window and is listed in the **Open Documents** list bar.

Stand-alone reports can be saved as HTML files or printed:

- To save a report as an HTML file right-click inside the report and select **Save As...**
- To print a report right-click inside the report and select **Print**. A **Print Preview** is also available from the context menu.
- To select the **contents** and the **format** of the report right-click and select **Properties...** from the context menu or click  in the **Reports** toolbar. For further details refer to: [Configure a Report](#).

Some or all of the following information will appear in the report depending on the type of network, the type of observations included and the contents of the report as configured in the [Report Template properties - Contents](#) page:

- [Project Information](#)
- [General Information](#)
- [Configuration Defects](#)
- [Check of Input Data](#)

Project Information

This section gives the Project name and the version of the integrated Adjustment processing kernel.

General Information

The **Type** of network may be:

- Inner constrained - No points in the network are held fixed.
- Minimally constrained - One position and one height held fixed, (not necessarily on the same point). The adjustment will tend to swing the network around the fixed point.
- Fully constrained - Two or more points are kept fixed.
- Weighted constrained: Control points are treated fixed according to their standard deviations. This can be configured in the [General Adjustment Parameters: Known Station](#) page.

Stations

Lists the number of (partly) known and unknown stations.

Observations

Lists the type and number of observations contained in the network as well as the Inner constraints.

The inner constraints is the datum defect of the network. In case of a free GPS network it will be set to 3. This means that 3 artificial constraints have been set in order to be able to calculate the adjustment. In case of a network combining terrestrial and GPS measurements the datum defect will be set to 7 (depending on the terrestrial observations used). In case of a free adjustment of height difference observations it will be set to 1. When at zero, the adjustment is constrained by the user in some way.

Unknowns

Lists the type and number of unknown elements that will be computed by the network adjustment computation.

The **Degree of freedom** is calculated from the number of observations (including the inner constraints) minus the number of unknowns.

Configuration Defects

Reports on unknowns which cannot be solved (singularities).

Check of Input Data

- Observations:**
This reports on multiple observations to the same point that differ by a certain amount and therefore may be suspect. If there is a high probability that an error exists, this will be marked with  at the end of the line. Other reported suspect observations are left to the discretion of the user.
- Observations and Approximate Coordinates:**
This reports on observations checked against the pseudo-observations derived from the approximate coordinates. Those observations where a large difference is identified are listed.
- Possibly Identical Observations:**
This reports on observations which are suspect to be identical. You may wish to inspect, if these are really separate observations.
- Possibly Coinciding Stations:**
This reports on stations which have a distance smaller than 2 meters. Such stations are suspect to be identical, but have not been given the same point Id.

Adjustment Network Report

To get an overview on the adjustment that has been performed for your network you may invoke the **Adjustment Network Report**.

- From the **Adjustment** main menu select **Results** and then  **Network** to get a report on the adjustment that has been performed for your network.
Alternatively: Right-click and select **Results** and then **Network** from the background context menu.

The report opens in a stand-alone window and is listed in the **Open Documents** list bar.

Stand-alone reports can be saved as HTML files or printed:

- To save a report as an HTML file right-click inside the report and select **Save As...**
- To print a report right-click inside the report and select **Print**. A **Print Preview** is also available from the context menu.
- To select the **contents** and the **format** of the report right-click and select **Properties...** from the context menu or click  in the **Reports** toolbar. For further details refer to: [Configure a Report](#).

Some or all of the following information will appear in the report depending on the type of adjustment, the type of observations included in the adjustment computation and the contents of the report as configured in the [Report Template properties - Contents](#) page:

- [Project Information](#)
- [General Information](#)
- [Input data](#)
- [Adjustment Results](#)
- [Testing and Estimated Errors](#)
- [Warning Messages](#)

Project Information

This section gives you general information on the [Project Properties](#), like the project name, creation date and time, the time zone and the attached coordinate system. You also get information on the version of the integrated Adjustment processing kernel.

If information has been entered in the [Dictionary](#) page of the Project Properties dialog these pieces of information will be added to this section of the report.

General Information

Adjustment

This section gives you general information on the type of adjustment that has been performed.

The **Type** of network may be:

- Inner constrained: none of the points in the network is kept fixed.
- Minimally constrained: one position and one height are kept fixed (not necessarily on the same point). The adjustment will tend to swing the network around the fixed point.

- Fully constrained: two or more points are kept fixed.
- Weighted constrained: Control points are treated fixed according to their standard deviations. This can be configured in the [General Adjustment Parameters: Known Station](#) page.

The dimension is indicated as set in the [General Adjustment parameters: Control](#) page.

Coordinate system and Height mode are indicated as set in the [General Adjustment parameters: Coordinate System](#) page.

The number of iterations that were taken in order to reach the maximum coordinate correction is given. The iteration criteria and maximum number of iterations are defined in the [General Adjustment parameters: Control](#) page.

Stations

This sections shows the number of (partly) known or fixed stations and the number of unknown stations in the computation.

Observations

Lists the type and number of observations contained in the network as well as the inner constraints and the transformation parameters that have been selected for computation. If points are kept fixed for the adjustment, the known coordinates are also counted as observations.

The inner constraints is the datum defect of the network. In case of a free GPS network it will be set to 3. This means that 3 artificial constraints have been set in order to be able to calculate the adjustment. In case of a network combining terrestrial and GPS measurements the datum defect will be set to 7 (depending on the terrestrial observations used). The inner constraints of a free adjustment of height difference observations will be set to 1. When at zero, the adjustment is constrained by the user in some way.

Unknowns

Lists the type and number of unknown elements that will be computed by the network adjustment computation.

The **Degree of freedom** is used to compute the sigma a posteriori and is defined as the number of observations (including the inner constraints) minus the number of unknowns.

Testing

[Example:](#)

Testing

Alfa (multi dimensional):	0.7072	
Alfa 0 (one dimensional):	5.0 %	
Beta:	80.0 %	
Sigma a-priori (GPS):	20.0	
Critical value W-test:	1.96	
Critical value T-test (2-dimensional):	2.42	
Critical value T-test (3-dimensional):	1.89	
Critical value F-test:	0.96	
F-test:	1.44	 (rejected)

Results based on a-posteriori variance factor

Displays the various values computed for the various tests that will be made in the adjustment computation.

-Alpha (multi dimensional) - Level of significance of multi-dimensional F test.
-Alpha (one-dimensional) - Level of significance of one-dimensional W-test.
-Beta - The power of all tests.
-Sigma a-priori (GPS) - The entered value that will compensate for the generally over optimistic nature of GPS standard deviations. This can be set to be applied or not under Configuration, [General Adjustment Parameters: Test Criteria](#).

-Critical value [W-test](#) - Value above which an observation will fail the W-test. Test of one dimension.
-Critical value [T-test](#) - Value above which an observation will fail the T-test. Test of 1 or 2 or 3 dimensions depending on the observation or coordinate type to be tested.
-Critical value [F-test](#) - Test of whole network. A global value that should approximate to 1.

F-test - The result of the F-test, which confirms the correctness of the stochastic model of the global network (sigma a posteriori). It is stated below this whether or not the sigma a posteriori has been applied to the results.

Input data

Depending on the type of adjustment and the type of included observations the report may be configured to show the following sub-sections:

- Approximate Coordinates:**
The unadjusted input coordinates of all stations are given. Fixed stations are marked in the report.
- Additional Parameters:**
In this sub-section the **General transformation parameters** and the **Terrestrial parameters** are listed as they have been set under **Configuration - General parameters - Coord. System** and **Configuration - Terrestrial Parameters**. The terrestrial parameters are applied to **Terrestrial observations** included in the adjustment.
- Observations:**
The unadjusted observations are displayed: the observation type, the **Station** name (this might be a GPS reference station, a TPS setup or the start point of a level line), the **Target** name (this might be a GPS Rover, a TPS target or the end point of a level line), the Instrument height (**St ih**) (terrestrial observations only), the target height (**Tg ih**) (terrestrial observations only) and the actual observation value (**Reading**).
- Standard Deviations:**
The following information is given in a six column table:
Observation type, the **Station** name (this might be a GPS reference station, a TPS setup or the start point of a level line) the **Target** name (this might be a GPS Rover, a TPS target or the end point of a level line). Then for terrestrial measurements the absolute part of the standard deviation (**Sd abs**), the relative part of the standard deviation (**Sd rel**) and the total standard deviation (**Sd tot**) calculated from the absolute and relative standard deviations and the centring and height errors.

For GPS observations, the three columns (**Cor**) are used to display the correlation matrix calculated from the co-variance information supplied from baseline processing or input by the user.

Note that the **Centring error** and the **Height of instrument error** (if used) are included in the input standard deviations.

Adjustment Results

Depending on the type of adjustment and the type of included observations the report may be configured to show the following sub-sections:

- Coordinates:**
These are the adjusted coordinates. The **Station** name is given, followed by the coordinate (e.g. Latitude/ Longitude, Easting/ Northing or Height), the adjusted **Coordinate** value and the adjusted value minus the

approximate (unadjusted) value (**Corr**). The standard deviation (**Sd / Prec**) of the adjusted value will be presented at the confidence level specified in the [Report Template Properties: Confidence Levels](#) page.

[Example:](#)

Coordinates

Station	Coordinate	Corr	Sd		
157-182	Latitude	46° 53' 06.28265" N	-0.0002 m	0.0066 m	
	Longitude	13° 31' 34.39944" E	0.0039 m	0.0038 m	
	Height	890.2463 m	-0.0447 m	0.0159 m	
157A-182	Latitude	46° 52' 58.13907" N	0.0013 m	0.0106 m	
	Longitude	13° 30' 42.67026" E	-0.0004 m	0.0101 m	
	Height	728.9362 m	0.0037 m	0.0263 m	
159-182	Latitude	46° 54' 09.42748" N	0.0000 m	-	fixed
	Longitude	13° 31' 04.29143" E	0.0000 m	-	fixed
	Height	1061.1185 m	0.0000 m	-	fixed

Additional Parameters:

The additional parameters specified in the Options menu under Configuration, [Terrestrial Parameters](#) and the transformation parameters [General Parameters: Coordinate System](#) are given as used to match GPS and terrestrial observations.

For each additional parameter the adjusted value for the parameter (**Adj val**), the adjusted value minus the approximate (unadjusted) value (**Corr**) and the standard deviation of the adjusted parameter (**Sd**) are displayed.

[Example:](#)

Additional Parameters

	Adj val	Corr	Sd
Scale factor S0:	0.9999960916	-0.0000039084	0.0000008068
Vertical refraction coefficient Z0:	0.20	0.07	0.03
GPS rotation x-axis:	13.64712 "	13.64712 "	0.30180 "
GPS rotation y-axis:	-38.49551 "	-38.49551 "	0.53676 "
GPS rotation z-axis:	-9.99997 "	-9.99997 "	0.27561 "
GPS scale factor:	1.0000044900	0.0000044900	0.0000005855

Observations and Residuals

The adjusted observations are presented. The observation type (e.g. DX or DH) is given followed by the instrument **Station** name (this might be a GPS reference station, a TPS setup or the start point of a level line), the **Target** name (this might be a GPS rover, a TPS target or the end point of a level line), the adjusted observation value (**Adj obs**), the unadjusted value minus the adjusted value (**Resid**), the correction in Easting, Northing and Height (**Resid (ENH)**) and the standard deviation of the adjusted value (**Sd**).

Via a hyperlink on the observation type you may enter the [Observations](#) dialog from inside the report to inspect the observation properties.

Note that this functionality is not available if the observation is the result of a Sets of Angles application **and** Sets of Angles results **are configured to be used** in the [General Adjustment Parameters: Control](#) page.

[Example:](#)

Observations and Residuals

	Station	Target	Adj obs	Resid	Resid (ENH)	Sd
R0	159-182	8-73018	390.82849 gon	-0.00044 gon	-	0.00076 gon
S0			2749.5587 m	-0.0007 m	-	0.0043 m
Z0			107.60310 gon	0.00630 gon	-	0.00057 gon
R1	159-182	8-73018	390.82908 gon	-0.00018 gon	-	0.00076 gon
Z0			107.60310 gon	0.00600 gon	-	0.00057 gon
R2	159-182	8-73018	278.63481 gon	0.00004 gon	-	0.00076 gon
R3	159-182	8-73018	256.00198 gon	0.00012 gon	-	0.00076 gon
DX	159-182	8-73013	640.7520 m	-0.0514 m	-0.0165 m	0.0087 m
DY			398.5367 m	-0.0293 m	0.0283 m	0.0051 m
DZ			-1082.5067 m	-0.0194 m	-0.0530 m	0.0084 m

- GPS Baseline Vector Residuals:**
If GPS observations are included in the adjustment this section will be included in the logfile. It shows the length of the baseline (**Adj. vector**), the residual for each baseline vector and its corresponding value in terms of parts-per-million (ppm) with respect to the baseline length.

- External Reliability:**
This can be defined as the largest effect of an undetected error on a coordinate component due to a connected observation.

For each **Station** name and coordinate component (e.g. Latitude/ Longitude, Easting/ Northing or Height) the external reliability (**Ext Rel**) is displayed together with the observation or fixed station coordinate that causes the external reliability value.

[Example:](#)

External Reliability

Station		Ext Rel [m]		Station	Target
157-182	Latitude	0.0157	Latitude	159-182	-
	Longitude	0.0167	Longitude	306-182	-
	Height	0.0344	Height	3-73018	-
157A-182	Latitude	0.0352	S0	331-182	157A-182
	Longitude	0.0191	Longitude	3-73018	-
	Height	0.0579	Height	3-73018	-

- Absolute Error Ellipses:**
These are the error ellipses for each point. The **Station** is given followed by the magnitude of the axes of the ellipse (**A** and **B**), the ratio of A to B (**A/B**), the angle about which the ellipse is rotated (**Psi**) relative to North and the height precision (**Sd Hgt**). Values for **A**, **B** and **Sd Hgt** are displayed at the given confidence level as specified under [Report Template Properties: Confidence Levels](#).

- Relative Error Ellipses:**
The relative error ellipses give an indication of the precision between two connected stations.

The connected **Stations** are given followed by the magnitude of the axes of the ellipse (**A** and **B**), the ratio of A to B (**A/B**), the angle about which the ellipse is rotated (**Psi**) relative to the connecting line between the two stations and the relative height precision (**Sd Hgt**). Values for **A**, **B** and **Sd Hgt** are displayed at the given confidence level as specified under [Report Template Properties: Confidence Levels](#).

Testing and Estimated Errors

Depending on the type of adjustment and the type of included observations the report may be configured to show the following sub-sections:

- Coordinate Tests:**
This section only appears when known (fixed) coordinates are used. The **Station** name is given followed by the coordinate component, the minimal detectable bias (**MDB**), which is the minimum value of error that can be detected by the outlier test, the Bias to Noise Ratio (**BNR**) which is the effect of the MDB on the

network (consistency is desirable here), the value of the **W-test** (outlier test for each coordinate component) and the value of the **T-test** (outlier test for coordinate triplet). Possible outliers (fail W-test and/or T-test) are marked with .

Observation Tests:

The results of the statistical tests performed upon the observations are presented. The observation type is given followed by the instrument **Station** name (this might be a GPS reference station, a TPS setup or the start point of a level line), the **Target** name (this might be a GPS rover, a TPS target or the end point of a level line), the minimal detectable bias (**MDB**) which is the value below which outliers cannot be detected, the redundancy (**Red**) of the observation in percentage terms, the bias to noise ratio (**BNR**) which is the effect of the MDB on the whole network (consistency is desirable here), the **W-test** value and the **T-Test** value for a complete GPS baseline vector. If points are connected to the network with only a single (free) observation, then this observation cannot be tested and the values will not be available. Observations that fail the W-test and/or the T-test are considered outliers and will be marked with .

[Example:](#)

Observation Tests

	Station	Target	MDB	Red	BNR	W-Test	T-Test
R0	159-182	8-73018	0.00528 gon	79	0.1	-0.29	
S0			0.0332 m	84	1.1	-0.07	
Z0			0.00957 gon	97	0.4	1.90	
R1	159-182	8-73018	0.00528 gon	79	0.1	-0.12	
Z0			0.00957 gon	97	0.4	1.81	
R2	159-182	8-73018	0.00528 gon	79	0.1	0.03	
R3	159-182	8-73018	0.00528 gon	79	0.1	0.08	
DX	159-182	8-73013	0.0801 m	97	0.7	0.03	1.72
DY			0.0353 m	85	1.1	-1.45	
DZ			0.0607 m	82	1.3	-1.09	

Redundancy Graphics:

The distribution of the redundancy numbers of all observations is graphically displayed in a histogram. The percentage of observations which have a redundancy lower than 10 is marked with a red bar.

[Example:](#)

Redundancy:

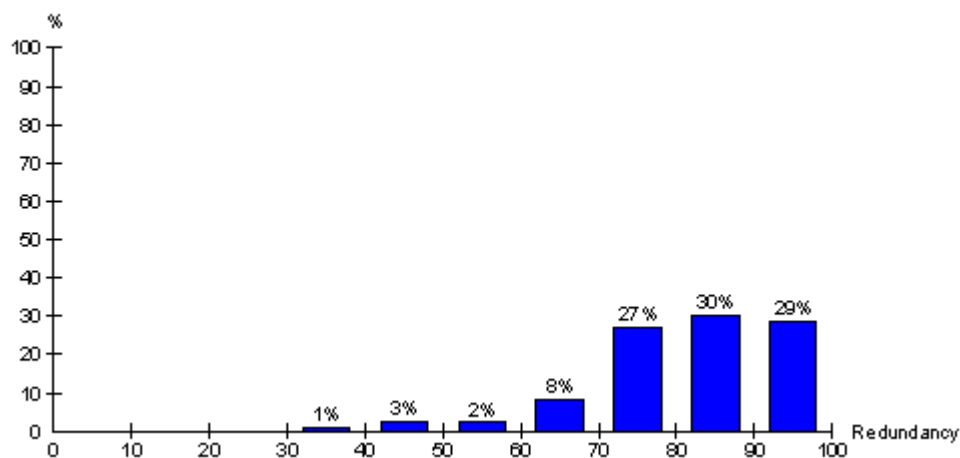

- Right-click into the histogram to get access to **Copy** and **Save** functionality for the graphics.

Observation Test Graphics (W-Test, T-Test):

The distribution of the results of the **W-Test** and the **T-Test** is graphically displayed in a histogram. The percentage of observations which are above the critical value for each test are marked with a red bar.

[Example:](#)

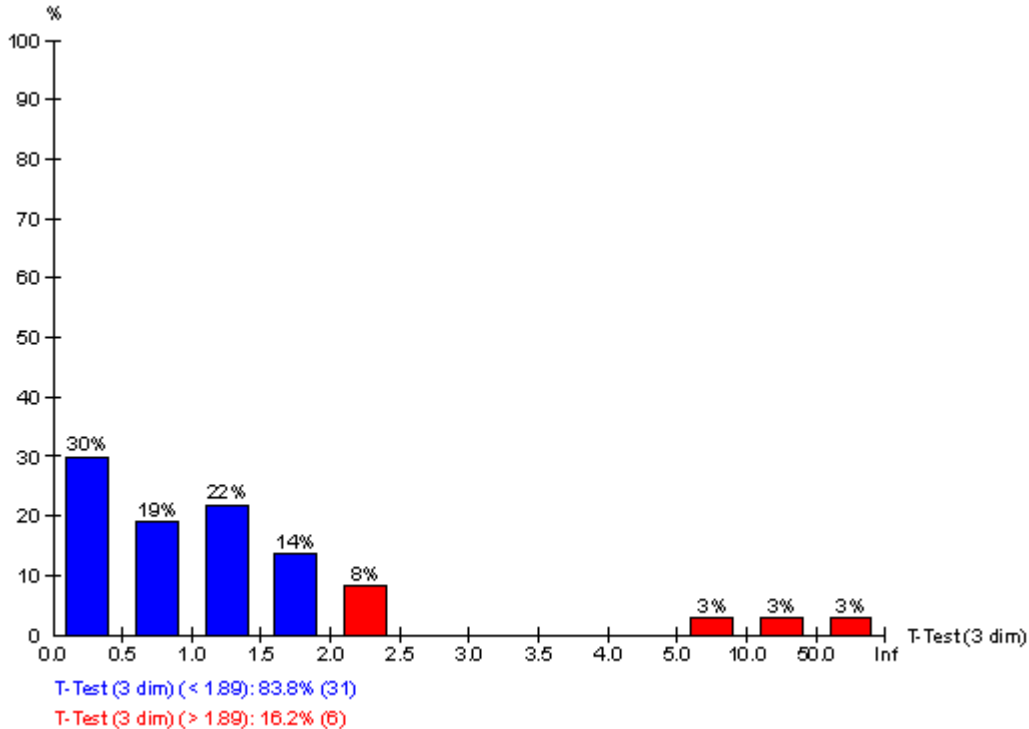

- Right-click into the histogram to get access to **Copy** and **Save** functionality for the graphics.

Estimated Errors (Coordinates):

This section may contain the following tests performed on the fixed station coordinates:

Estimated Errors for Coordinates with Rejected W-Tests:

The 10 coordinates that fail the **W-test** by the largest amount are presented with an estimation of the error that could have caused the rejection. The **Station** name is given followed by the coordinate component, the **W-test** value, the **Factor** by which the W-test critical value is exceeded and the estimated error (**Est err**).

Estimated Errors for Stations with Rejected T-Tests

This is very similar to the above but is in terms of the 3-dimensional T-Test on points. Therefore, the estimated errors are presented as vector components.

Estimated Errors (Observations):

This section may contain the following tests performed on the observations:

Estimated Errors for Observations with Rejected W-Tests:

The 10 observations that have failed the W-test by the largest amount are displayed in descending order of magnitude of failure. The observation type is given followed by the **Station** name (this might be a GPS reference station, a TPS setup or the start point of a level line), the **Target** name (this might be a GPS rover, a TPS target or the end point of a level line), The **W-test** value, the factor (**Fact**) by which the observation failed the test and the estimated error (**Est err**) of the observation.

Estimated Errors for Observations with Rejected T-Tests:

This is very similar to the Estimated Errors for Observations with Rejected W-Tests but is concerned with the 3 dimensional observation and not with single components of observations.

Estimated Errors for Observations with Rejected Antenna Height W-Tests:

If an error in GPS Antenna heights is suspected, an estimation of this error is given. The observation type is given followed by the instrument **Station** name (GPS reference station), the **Target** name (GPS rover), the **W-test** value, based upon the alternative hypothesis of an **antenna height error**, the factor (**Fact**) by which the value exceeds the critical value of the W-test, the minimal detectable bias (**MDB**) and the estimated

antenna error (**Est ant err**).

Error Messages

All errors and warnings occurring during the adjustment computation are listed in this section.

Adjustment Loops Report

To get an overview on the loops computation that has been performed for your network you may invoke the **Adjustment Loops** Report.

- From the **Adjustment** main menu select **Results** and then **Loops** to get a report on the Loops computation that has been performed for your network.
Alternatively: Right-click and select **Results** and then **Loops** from the background context menu.

The report opens in a stand-alone window and is listed in the **Open Documents** list bar.

Stand-alone reports can be saved as HTML files or printed:

- To save a report as an HTML file right-click inside the report and select **Save As...**
- To print a report right-click inside the report and select **Print**. A **Print Preview** is also available from the context menu.
- To select the **contents** and the **format** of the report right-click and select **Properties...** from the context menu or click  in the **Reports** toolbar. For further details refer to: [Configure a Report](#).

Some or all of the following loop types will be reported depending on the kind of observations used and the contents of the report as configured in the [Report Template properties - Contents](#) page:

- [Project Information](#)
- [GPS Baseline Loops](#)
- [Direction and Distance Loops](#)
- [Zenith Angle and Distance Loops](#)
- [Height Difference Loops](#)
- [Warning Messages](#)

Project Information

This section gives you general information on the [Project Properties](#), like the project name, creation date and time, the time zone and the attached coordinate system.

If information has been entered in the [Dictionary](#) page of the Project Properties dialog these pieces of information will be added to this section of the report.

Additionally this section displays the **Critical value** for the outlier tests performed on the loops and the **Dimension** as defined in the [General Adjustment Parameters: Control](#) page.

GPS Baseline Loops

[Example:](#)

Loop 1

From	To	dX[m]	dY[m]	dZ[m]
159-182	3-73018	2302.9718	-1950.3427	-1573.2470
3-73018	306-182	-892.1744	4465.0318	102.1715
306-182	159-182	-1410.8098	-2514.6796	1471.0609
X:	-0.0124 m	W-Test:	-0.45	
Y:	0.0095 m		0.65	
Z:	-0.0146 m		-0.60	
Easting:	0.0121 m	W-Test:	0.77	
Northing:	-0.0028 m		-0.11	
Height:	-0.0174 m		-0.68	
Closing error:	0.0214 m	(1.9 ppm)	Ratio:	(1:523571)
Length:	11194.7417 m			



In this section all the GPS Baseline Loops that have been found and calculated in your network are listed.

For each loop the points making up the loop are given followed by the **closing error** in Cartesian WGS84 coordinates and the **length** of the error vector. An outlier test is performed for each loop. The value of the **W-test** (outlier test for each coordinate component) is displayed next to the closing errors in X, Y and Z. Possible outliers, which fail the W-test, are marked with .

Direction and Distance Loops

[Example:](#)

Loop 1

From	To		
1	2		
2	3		
3	4		
4	5		
5	1		
X:	-0.0198 m	W-Test:	-2.11 
Y:	-0.0078 m		-0.71
Closing error Angles:	0.00787 gon		2.28 
Closing error:	0.0212 m	(34.3 ppm)	Ratio:(1:29175)
Length:	619.7674 m		

In this section all the Direction and Distance Loops that have been found and calculated in your network are listed.

For each loop the points making up the loop are given followed by the **closing error** for the angle and for the local coordinates X and Y. The closing errors in X (local Easting) and Y (local Northing) are computed in a local XY system, with the positive Y axis parallel to the first side of the loop, and the X axis perpendicular to it. An outlier test

is performed for each loop. The value of the **W-test** is displayed next to the closing errors. Possible outliers, which fail the W-test, are marked with .

Zenith Angle and Distance Loops

In this section all the Zenith Angle and Distance Loops that have been found and calculated in your network are listed.

For each loop the points making up the loop are given followed by the **closing error** in height derived from the trigonometric height differences in the loop. An outlier test is performed for each loop. The value of the **W-test** is displayed next to the closing error. Possible outliers, which fail the W-test, are marked with .

Height Difference Loops

In this section all the Height Difference Loops that have been found and calculated in your network are listed.

For each loop the points making up the loop, the height differences and the distances of the level lines are given followed by the **closing error** in height and the total length of the loop. An outlier test is performed for each loop. The value of the **W-test** is displayed next to the closing error. Possible outliers, which fail the W-test, are marked with .

Warning Messages

All errors and warnings occurring during the loops computation are listed in this section.

All about Adjustment

All about Adjustment

Explains why adjustment is necessary, the mathematics and statistics behind it and how the testing is carried out.

[Introduction](#)

[Least Squares Adjustment](#)

[Precision and Reliability](#)

[Statistical Testing](#)

Introduction

It is important for a surveyor, as for any other professional, to assess and control the quality of his work. The reasons for this are obvious:

- the work will have to meet certain requirements, so it is essential to be able to assess whether the requirements are met;
- when for some structural (bad design) or incidental reason (observation error) the requirements are not met, tools must be available to improve the situation.

Knowing about the costly consequences of ill-designed networks or undetected errors, especially when these deficiencies are discovered in an advanced stage of the survey, it is clear that quality control will save both time and money. Quality control has gained importance in survey work due to the instrumental developments in recent years. Modern survey instruments are capable of producing a bulk of survey data, thus demanding efficient tools for assessing their sufficiency and accuracy.

Besides instrumental developments, also developments in survey software have opened the way for an increase in the application of quality control. Not long ago the quality assessment of survey networks by means of reliability parameters and statistical testing, was reserved for specialists able to operate complex computer systems. Nowadays by the introduction of easy to operate PC based software packages, quality control can reach professionals on all sorts of different levels.

In this part of the manual quality control for geodetic networks is introduced by means of a review of (the parameters of) precision and reliability, according to the 'Delft Method':

- The control of the propagation of random errors, present in the observations, into the coordinates is measured in terms of precision.
- The identification of gross errors and/or biases in the observations and the control over the sensitivity of the data to these errors and biases is measured in terms of reliability.

Relationship between Adjustment, Precision, Reliability and Testing

From observations carried out in the field, the surveyor will have to compute an end result: the coordinates. When redundant observations are available, as it should be, a strategy has to be chosen so as to get a unique and optimal solution. In geodesy, this strategy usually is the least squares adjustment. It is based on the following criterion: the sum of squares of the observational residuals must be minimized. After carrying out a least squares **adjustment** we know that we have the best possible solution based on the available observations.

Having determined a solution, it is important for the surveyor to be able to assess the quality of this solution. It is therefore necessary to somehow quantify the quality. By doing so, it can be verified whether the network meets the requirements. For example, a surveyor working as a contractor will know before delivery whether or not and to what extent the quality of the network meets the client's demands. This works two ways:

- a network of poor quality will not be accepted by the client, this will obviously cause problems;
- a network with a far better quality than asked for by the client, is often undesirable from a cost-efficiency point of view.

The **quality** of a network, whether already measured or only existing as a design, can be assessed in terms of **precision** and **reliability**. Both precision and reliability can be quantified by parameters which will be discussed in the other topics.

By designing a network keeping in mind the demands on precision and reliability, it is possible to control the quality. However, designing a 'perfect' network is not enough. Practice has learned that, mainly due to human failures, about 1 in every 100 observations is erroneous.

This means that the quality control will have to include some sort of **statistical testing**, in order to clear the result of possible outliers. The effectiveness of the testing will depend on the reliability of the network. The more reliable a network is, the higher the probability that outliers will be detected by the testing.

The explanation above should clarify the relationship between the least squares adjustment, the precision and reliability concept, and the statistical testing. To summarize, one could say that:

- the least squares adjustment will produce the best possible result, given the available data;
- the statistical testing checks the result in order to make it 'error-free';
- the precision and reliability parameters quantify the quality of the result.

Quality Control in Network Planning

As explained in [Relationship between Adjustment, Precision, Reliability and Testing](#), the quality of a network can be assessed in terms of precision and reliability. This valuation may take place before the start of the actual measurements in the field, namely during the **planning** or **design** of the network. Usually the study of topographic maps of the area and reconnaissance in the field precedes the initial design. The outcome of the (initial) network design depends on the purpose of the network and on related demands on precision and reliability. Furthermore the location of the known stations and the characteristics of the area (e.g. mountainous or flat) can affect the design.

A number of general rules of thumb apply for network design:

- Aim for a balanced distribution of known stations over the network. Moreover, the integration of known stations should be acceptable from a precision and reliability point of view, e.g. an intersection by at least three, preferably four directions.
- Try to include loops in the network, keeping in mind that the lesser the number of stations in a loop, the better the reliability. In 2D networks, the reliability of loops can be improved by measuring directions and distances to temporarily monumented auxiliary stations.
- Strive for network sides of approximately equal length.

Note that when establishing a GPS network with a number of simultaneously operating receivers (at least three), the actually planned network configuration can be altered even after completion of the measurements in the field. In case of N receivers, the number of possible baselines is $N*(N-1)/2$. However, only a subset of $N-1$ linearly independent baselines should be selected for computation in the raw data processing.

Precision and reliability of a network design can be examined based on the following input:

- Approximate coordinates of all stations, e.g. scaled off from topographic maps. (Since observation readings are not available, approximate coordinates can not be computed.)
- Observations, i.e. not the actual readings but station and target information, and the intended type of observation.
- Known stations
- The stochastic model of observations and known stations, i.e. a-priori standard deviations.

The output of the design computation is:

- Absolute and relative standard ellipses.
- A-posteriori standard deviations of observations.
- A-posteriori standard deviations of stations.
- Minimal Detectable Bias (MDB) of observations.
- Minimal Detectable Bias (MDB) of known stations.
- Bias to Noise Ratio (BNR) of observations.
- Bias To Noise Ratio (BNR) of known stations.

Based on this output, the network can be further improved until the requirements are satisfied. The design process is presented by the scheme below.

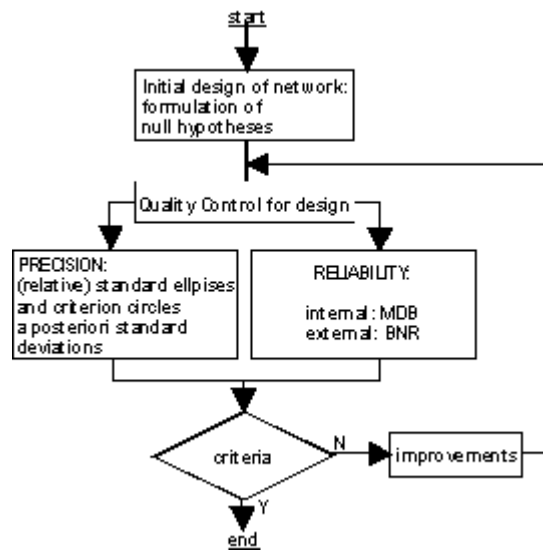

Least Squares Adjustment

Least Squares Adjustment

In this section the basic ideas of least squares adjustment are introduced, together with the concepts of mathematical and stochastic models. Furthermore, important notions such as approximate values, nuisance parameters, and constraints are explained.

[General Remarks on Least Squares Adjustment](#)

[Mathematical Model](#)

[Stochastic Model](#)

[Free and Constrained Adjustments](#)

[Formulae](#)

Least Squares Adjustment: General remarks

It is common practice for a surveyor to carry out extra measurements when establishing a geodetic network. This will enable compensation for a possible loss of observations and, more important, the quality of the network can be improved. As a consequence of the extra measurements there is no longer a unique solution which satisfies the conditions in the network exactly (e.g. the angles of a triangle should add up to 200 gon). Therefore a method is needed to correct the observations in order to make them meet the conditions. The amount by which each observation has to be corrected is called the observation residual. The **least squares adjustment** method will make the observations fit into the model by minimizing the sum of squares of the observation residuals. The residuals are referred to as **least squares corrections**.

Any least squares adjustment model consists of two equally important components: the mathematical model and the stochastic model. The mathematical model is a set of relations between the observations and the unknowns. The stochastic model describes the expected error distribution of the observations.

Mathematical Model

Usually in a survey, the observables themselves are not the quantities, which we are aiming for. Instead, we use the observations to determine unknown parameters, e.g. the coordinates of stations in a network. The observations are expressed as a function of the parameters in the so-called functional or **mathematical model**.

In some cases, the model representing the relations between the observables and the unknown parameters is very simple. The relation, for instance, in a 1-dimensional leveling problem between the observed height differences and the unknown heights is simply linear:

$$\Delta X_{ij} = h_j - h_i$$

More complicated is the case for a GPS network where the unknowns are coordinates (X,Y,Z) to be determined in a reference system different from that of the observed baselines ΔX :

$$\Delta X_{ij} = \text{function} (\alpha, \beta, \gamma, \mu, X_{1f}, Y_{1f}, Z_{1f}, X_{jf}, Y_{jf}, Z_{jf})$$

with

$\alpha, \beta, \gamma, \mu$ as transformation parameters.

As the least squares approach requires linear equations, the model above must be linearized. Usually this means that a number of **iterations** is needed to reach a solution. Moreover, **approximate values** for the coordinate unknowns in the adjustment are required. Bad approximate values can lead to an increasing number of iterations or, in the worst case, to no convergence at all.

Since coordinates are our main concern, other unknowns in the mathematical model are not always useful for us. Unknowns such as the transformation parameters mentioned above, are called additional or **nuisance** parameters. Typical nuisance parameters are: transformation parameters, scale factors, azimuth offsets, orientation unknowns and refraction coefficients. Some of these parameters can be kept fixed at a certain value, in which case they are not corrected in the adjustment. Whether or not to fix parameters is a question which can not easily be answered. We must always be careful to avoid overconstraining as well as overparameterization. The introduction of refraction coefficients for example, could result in the absorption of systematic effects which are not caused by refraction. However, ignoring the refraction, when in fact it does have an influence on the measurements, will cause an equally unfavourable effect. The success of what could be referred to as 'tuning' of the model will depend largely on the user's expertise.

A scale factor may be estimated for the distance measurements. The aim of introducing a free scale factor in the adjustment is to overcome a possible bias in the internal scale of the measurement equipment and, in more general terms, to prevent the overconstraining of the network in a free adjustment. A free scale factor will 'shrink' or 'blow up' the network in order to make it fit onto the known stations in constrained adjustments. As a result, in some situations a free scale factor may obstruct the statistical testing of known stations. An outlier in the coordinates of a known station could remain undetected when, due to the 'shrink' or 'blow up' effect, the network can still be forced to fit the known stations without any rejections. The outlier in question is absorbed by the scale factor, which will consequently have a value distinctly different from 1.0. It is therefore recommended to examine the value of the scale factor after the adjustment and, in case of doubt, to re-run the adjustment with a fixed scale.

An adjustment will fail when the mathematical model, as represented by the design matrix and normal matrix (see [Formulae](#)), is singular. Singularity is caused by:

- an ill-posed problem;
- an improperly formulated model.

The problem may be ill-posed because we expect too much from the observations, or because too few observations were included. An example of an ill-posed problem is the determination of the 2D coordinates of an unknown station by a single horizontal direction from another station. A model is improperly formulated, when too many parameters are included. In general an improperly formulated model does not correctly represent the existing physical reality.

For computerized solutions to least squares problems the **ill-conditioning** of the normal matrix N could result in singularity.

Singularity is the limiting case of ill-conditioning. An ill-conditioned matrix can become 'singular' as a result of the internal accuracy limits of the computer hardware. An example of an ill-conditioned problem is the intersection of a station by two or more nearly parallel directions.

Apart from the problems mentioned above, an adjustment of terrestrial observations cannot be solved unless the location, orientation and scale of the network are established, i.e. a 'datum' must be defined. This is done by imposing **constraints** on the solution. The minimum number of constraints depends on the dimension of the network:

- In a **3D** network there are 3 translations, 3 rotations and 1 scale factor. The singularity is then eliminated by fixing at least 7 coordinates of 3 stations (Lat1, Lon1, h1, Lat2, Lon2, h2, h3).

Stochastic Model

A geodetic observable, such as a direction, distance or height difference, is a random or stochastic variable. A stochastic variable cannot be described by a single and exact value because there is an amount of uncertainty involved in the measurement process. For example, repeatedly measuring the distance between two stations will result in a range of different values. This variation is accounted for by a probability distribution. This means that in addition to the mathematical model, it is necessary to formulate a second model which describes the stochastic deviations of the observations; the **stochastic model**.

For geodetic observables a normal probability distribution is assumed (see below). This distribution is based on the **mean μ** and the standard **deviation σ** .

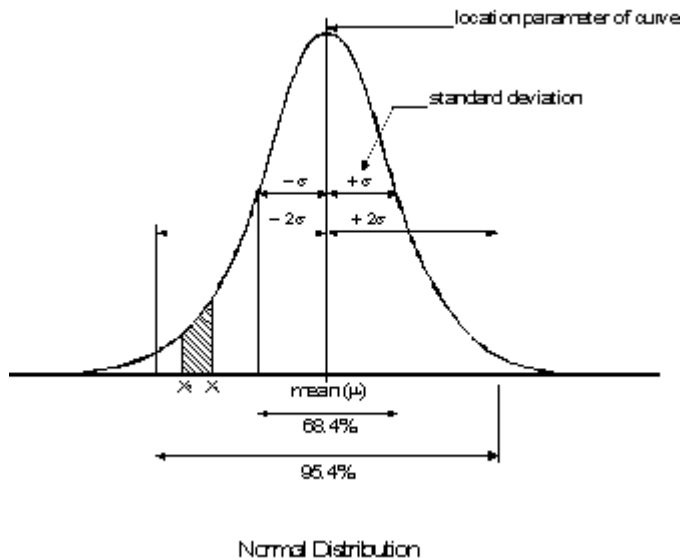

The mean μ represents the value of the mathematical expectation of the observable. The standard deviation is a measure of the dispersion or spread of the probability. The standard deviation characterises the **precision** of the observable (see [Precision](#)). The square of σ is called the **variance**. By definition there is a 0.684 probability that normally distributed stochastic variables will fall within a window limited by $-\sigma$ and $+\sigma$. For a window limited by -2σ and $+2\sigma$ this probability is 0.954. In general, the probability that a stochastic variable takes a value between x_1 and x_2 is equal to the area enclosed by the curve, and the x_1 and x_2 ordinates. This is the shaded area in the diagram above.

It is possible for two or more observables to be interdependent or **correlated**. This means that a deviation in one observable will influence the other. The correlation between two observables x and y is mathematically expressed by the covariance σ_{xy} . The covariance is also used in the correlation coefficient, defined as:

$$\rho = \frac{\sigma_{XY}}{\sigma_X \sigma_Y}$$

The coefficient takes values between minus and plus one:

$$-1 \leq \rho \leq 1$$

If the observables are not interdependent it follows that $\rho = 0$. The vector elements (DX,DY,DZ) of a GPS baseline are an example of correlated observables. To express this correlation a 3x3 matrix is used. This symmetric matrix is a combination of standard deviations and correlation coefficients:

$$\text{Des and Adjust } \rho - \text{matrix} = \begin{bmatrix} \sigma_{DX} & & \\ \rho_{DXDY} & \sigma_{DY} & \\ \rho_{DXDZ} & \rho_{DYDZ} & \sigma_{DZ} \end{bmatrix}$$

In essence the stochastic model consists of a choice for the probability distribution of the observables. Practically this means that for each observable a standard deviation σ is chosen. The value for σ is based on knowledge about the measurement process (conditions in the field, type of instrument) and experience. The standard deviation of most observables is supposed to consist of an absolute part, and a relative part. In the relative part the dependence on the distance between station and target, which characterises the precision of most observables, is accounted for. The thus defined standard deviations are entered in the variance-covariance matrix Σ_b (see [Formulae](#)). The precision of the unknowns in the adjustment depends on the precision of the observables given in Σ_b , and on the propagation of this precision through the mathematical model.

Free and Constrained Adjustments

The adjustment of a network is usually subdivided into two separate steps or phases:

- free network adjustment;
- constrained adjustment.

This approach is intended to separate the testing of observations and known stations.

A free network can be defined as a network of which the geometrical layout is determined by the observations only. The position, scale and orientation of the network are fixed by a minimum number of constraints, through the base stations. Thus, the base stations impose no extra constraints on the adjustment solution. In a free network adjustment the emphasis is laid on the quality control of the observations, rather than on the computation of coordinates. Selecting other stations to fix the position, scale and orientation will change the coordinates, but not the statistical testing.

Having eliminated possible outliers in the observations in the free adjustment, the network can be connected to the known stations. This does impose extra constraints on the solution. Now the emphasis is on the analysis of the known stations and on the computation of the final coordinates. There are two types of constrained adjustments: **absolutely** constrained and **weighted** constrained. The difference between these two types is in the coordinate computation. In an absolutely constrained adjustment the coordinates of the known stations are kept at their original value, i.e. they do not receive a least squares correction. An absolutely constrained adjustment is sometimes called a **pseudo least squares adjustment**. In a weighted constrained adjustment however, the known stations do receive a correction. The choice for an absolutely or weighted constrained adjustment leaves the testing results unchanged.

Formulae

The (linearized) mathematical model is:

$$b + e = Ax + a$$

with

b = (m) vector of observations;

e = (m) vector of corrections;

A = (m x n) design matrix;

x = (n) vector of unknowns;

a = (n) vector of constants.

The stochastic model is:

$$\Sigma_b = \sigma^2 Q = \sigma^2 P^{-1}$$

with

Σ_b = (m x m) variance-covariance matrix;

σ^2 = a-priori variance-of-unit-weight;

Q = (m x m) weight coefficient matrix;

P = (m x m) weight matrix.

The least squares criterion is:

$$e^t P e = \text{minimum}$$

The solution is:

$$x = N^{-1} A^t P (b - a)$$

$$s^2 = e^t P e / (m - n)$$

with

$N = (A^t P A)$, (n x n) normal matrix;

s^2 = a-posteriori variance-of-unit-weight.

The variance-covariance matrix of the unknowns:

$$\Sigma_x = \sigma^2 N^{-1}$$

Note : the a-priori σ^2 is used, not the a-posteriori s^2

In case of a linearized mathematical model, the solution for the vector of unknowns x is available after a series of iterative updates Δx of the approximate values:

$$x = x_0 + \Delta x$$

After each iteration, the new solution is compared with the previous one. If the difference between the two solutions satisfies the iteration criterion, the iteration process is ended and the last solution is regarded as final.

Precision and Reliability

Precision and Reliability

The result of an adjustment must be precise **and** reliable. It is not enough for an observation to be precise, meaning that repetition will lead to a high degree of closeness. Observations should also be reliable, i.e. close to the **true** value. The accuracy or, more generally, the quality of a network can therefore be described by two elements: precision and reliability. In this chapter, the parameters which quantify precision and reliability will be reviewed.

General remarks

Precision

Reliability

Precision and Reliability: General remarks

Before proceeding to a more in depth treatment, it is important to realize that precision and reliability are two separate notions. A measurement process can be very precise, but is therefore not necessarily reliable. On the other hand, a reliable process is not always a precise one. Compare the relative frequencies f_A and f_B of two measurement processes A and B (see diagrams below). The precision of process A is better than of process B; the degree of closeness of the observations in process A is higher. But although process A is more precise, it is not very reliable. A systematic error has resulted in a shift of the frequency distribution, away from the true value μ . Process B is not very precise, but definitely more reliable, since its distribution is close to the true value μ . In this section the precision and reliability concept is introduced, together with the tools implemented for the analysis of precision and reliability of a network.

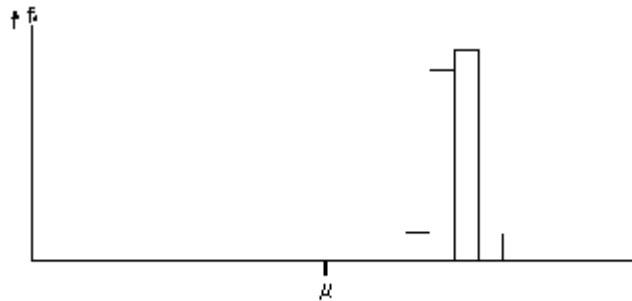

Relative frequency of measurement process A

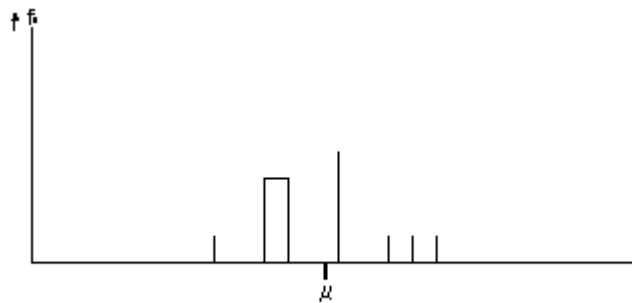

Relative frequency of measurement process B

Precision

In the **Least Squares Adjustment** section the standard deviation of an observable is introduced. It is necessary to describe an observation by both the measured value, and the standard deviation. The standard deviation expresses the stochastic variabilities of the observation. The precision of a network can be defined as the influence of the stochastic variabilities of the network observations on the coordinates.

The a-posteriori standard deviations of all observations and stations are presented. For presenting the precision of stations **standard ellipses** are often used. Standard ellipses can be regarded as the 2-dimensional equivalent of standard deviations. These ellipses are also known as confidence ellipses. There is a certain level of confidence, that a station can be found within the area enwrapped by its ellipse. For standard ellipses the level of confidence is 0.39 (to get a level of confidence of 0.95 the axes have to be multiplied by a factor 2.5). **Absolute** standard ellipses represent the propagation of random errors through the mathematical model into the coordinates. **Relative** standard ellipses represent the precision between station pairs. The shape of an ellipse is defined by the semi major axis A and semi minor axis B. The orientation of an absolute standard ellipse is defined by the angle Phi between the semi major axis and the Y-North axis of the coordinate system. The orientation of a relative standard ellipse is defined by the angle Psi between the semi major axis and the connecting line between station and target.

Reliability

The reliability of a network can be described in terms of the sensitivity to the detection of outliers. Reliability can be subdivided into **internal** and **external** reliability:

- **Internal reliability** is expressed by the **Minimal Detectable Bias** (MDB). The MDB presents the size of the smallest possible observation error, still detectable by the statistical test (datasnooping) with a probability equal to the power β of the test. A large MDB indicates a weakly checked observation or coordinate. Thus, the larger the MDB the poorer the reliability. If an observation is not checked at all, no MDB can be computed and the observation is marked as a 'free observation'.
- **External reliability** is expressed by the **Bias to Noise Ratio** (BNR). The external reliability is used as a measure to determine the influence of a possible error in the observations on the adjusted coordinates. The BNR of an observation reflects this influence, whereby the size of the observation error is defined equal to the MDB of that particular observation. The BNR is a dimensionless parameter combining the influence of a single observation on all coordinates. A practical interpretation can be given if we regard the BNR as an upperbound for the ratio between the influence ∇ of the MDB of an observation on any coordinate x , and the a-posteriori standard deviation σ of this coordinate:

$$\left| \frac{\nabla_x}{\sigma_x} \right| \leq \text{BNR}$$

In other words: the BNR can be interpreted as the ratio between reliability and precision. It is desirable that the BNR is homogeneous for the entire network.

An important quality of both the MDB and BNR is that they are **independent** of the choice of base stations.

To illustrate the behaviour of the reliability parameters, consider the example presented in the following table.

Observation	Reading (m)	MDB (m)	BNR	W-test
Distance A-B	1051.426	0.048	10.8	-0.76
Distance A-B + Δ	1051.476	0.048	10.8	3.53**

Example Internal and External Reliability

In this example the distance A-B is an observation in a network which has been adjusted and tested. As follows from the last column of the table, the testing has accepted this observation (critical value W-test = 3.29). The internal reliability is given by an MDB of 0.048 m. This means that an error of this size will probably be detected by the W-test (see [W-Test](#)). To verify this, an error Δ of 0.05 m is introduced in the distance A-B. The network is now adjusted and tested again, including this simulated error. Indeed as seen from the second value in the last column, the observation is now rejected by the W-test because the critical value is exceeded.

The external reliability is given by a BNR of 10.8. This means that the influence of the MDB of 0.048 m on any coordinate in the net, is smaller than 10.8 times the a-posteriori standard deviation of the coordinate. For general purpose networks it is desirable to have a homogeneous external reliability. The network in the example is considered as homogeneous, when the BNR values of all observations are on the same level. Alternatively the network is inhomogeneous when the BNR of e.g. distance A-B strongly exceeds the BNR of other observations in the network. In that case the network is unstable or inhomogeneous, i.e. the reliability depends mainly on the correctness of one single observation.

Statistical Testing

Statistical Testing

The aim of statistical testing is to check whether the mathematical and stochastic model (see [Least Squares Adjustment](#)) are a correct representation of 'reality'. Furthermore, it is important to detect possible outliers (blunders) in the observations which could ruin the achievable accuracy. This makes statistical testing essential for the process of quality control. The statistical testing presented here is carried out together with the least squares adjustment. It is based on the analysis of least squares residuals. The detection of blunders can also be carried out prior to the adjustment by e.g. a check on loop misclosures or on erroneous station numbering. These checks are regarded as part of the preprocessing and are not further discussed here.

Different types of statistical tests are implemented: the [F-test](#), [W-test](#) and [T-test](#). The T-Test is a 3-dimensional test and is, therefore, not available when adjusting pure Level observations.

In this section the testing procedures are explained, preceded by a general description of hypothesis testing. In the final paragraphs attention is paid to the interpretation of the testing results and estimated errors.

Related topics:

[General remarks](#)

[F-Test](#)

[T-Test](#)

[W-Test](#)

[Estimated Errors](#)

[Interpreting Test Results](#)

[Antenna Height-test](#)

Statistical Testing: General remarks

The mathematical and stochastic model are based on a set of assumptions. This set is called a statistical **hypothesis**. Different assumptions will result in different hypotheses. Statistical testing is used to verify the hypotheses. A special set of assumptions is referred to as the **null-hypothesis** H_0 . This hypothesis implies that:

- there are no gross errors (blunders) present in the observations;
- the mathematical model gives a correct description of the relations between the observations and the unknown parameters;
- the chosen stochastic model for the observations appropriately describes the stochastic properties of the observations.

It is clear that there are two possible outcomes for the testing of a hypothesis: acceptance or rejection. A specific cut-off point or **critical value** decides over acceptance and rejection. The critical values establish a window of acceptance. The further beyond this window, the less certain the set of assumptions is satisfied. Critical values are determined by the choice of a **level of significance** α . The probability that the critical value is exceeded, although the set of assumptions is valid, is equal to α . In other words, α is the probability of an incorrect rejection. Alternatively the complementary **level of confidence** $1-\alpha$, is a measure of the confidence one can have in the decision.

In the testing of the null-hypothesis H_0 there are two unfavourable situations that might occur:

- Rejection of H_0 while in fact it is true. The probability of this situation occurring is equal to the significance level α . This situation is called a Type I error (table below).
- Acceptance of H_0 while in fact it is false. The probability of this situation occurring is $1-\beta$, with β the **power** of the test. This situation is called a Type II error (table below).

SITUATION	DECISION: accept H_0	DECISION: reject H_0
H_0 true	correct decision: probability = $1-\alpha$	Type I error: probability = α
H_0 false	Type II error: probability = $1-\beta$	correct decision: probability = β

Testing of null Hypotheses

Methods are reviewed for testing the null-hypothesis and alternative hypotheses in [F-Test](#) , [W-Test](#) and [T-Test](#) .

F-Test

The F-test is a very commonly used multi-dimensional test for checking the null-hypothesis H_0 . The F-test is often called the overall model test, because it tests the model in general.

The F-value is given by the expression:

$$F = s^2 / \alpha^2$$

with

s^2 = a-posteriori variance factor, depending on the computed residuals and the redundancy;

α^2 = a-priori variance factor.

The F-value is tested against a critical value of the F-distribution, which is a function of the redundancy and the significance level α . There are three sources of rejection, further described below, namely: gross errors, incorrect mathematical model, and incorrect stochastic model.

The information provided by the F-test, namely acceptance or rejection of the null-hypothesis, is not very specific. Therefore if H_0 is rejected, it is necessary to find the cause of the rejection by tracing errors in observations or assumptions. If we suspect that the H_0 is rejected due to a gross error present in one of the observations, the W-test is required. The so-called **datasnooping** utilizes the W-test in order to seek for errors in individual observations. The F- and W-test are linked by a common value of the power β . This is the so-called B-method of testing. The W-test and the B-method are described in the next paragraph.

The H_0 is likewise rejected when the mathematical model is incorrect, or not refined enough. For example: the vertical refraction coefficient is disregarded, or observations related to different datums are combined without solving the parameters of the datum transformation. In this case the mathematical model has to be improved, in order to prevent an inferior outcome.

Another source of rejection is a too optimistic a-priori variance-covariance matrix. Such a rejection can easily be remedied by increasing the input standard deviations of the observations. Of course we should remain aware of the purpose of statistical testing; the purpose is not to have all observations accepted, but rather to detect outliers and model errors.

Of course a combination of the three sources of rejection above can also occur.

W-Test

A rejection of the F-test does not directly lead to the source of the rejection itself. In case the null-hypothesis is rejected, other hypotheses must be formulated which describe a possible error, or a combination of errors.

There is an infinite number of hypotheses which can be formulated as an alternative for the null-hypothesis. The more complex these hypotheses become, the more difficult they will be to interpret. A simple but effective hypothesis is the so-called **conventional alternative hypothesis**, based on the assumption that there is an outlier present in one single observation while all others are correct. The one-dimensional test associated with this hypothesis is the W-test.

The assumption of a single outlier is often very realistic. A strong rejection of the F-test can often be traced back to a gross error or blunder in just one observation. There is a conventional alternative hypothesis for each observation, which implies that each individual observation is tested. The process of testing each observation in the network by a W-test is called **datasnooping**.

The size of the least squares correction alone is not always a very precise indicator when checking the observations for outliers. A better test quantity, though only suited for uncorrelated observations, is the least squares correction, divided by its standard deviation. For correlated observations, e.g. the three elements of a baseline, the complete weight matrix of the observations must be taken into account. This condition is fulfilled by the test quantity W of the W-test, which has a standard normal distribution and is most sensitive for an error in one of the observations.

The critical value W_{crit} depends on the choice of the significance level α_0 . If $W > W_{crit}$ (the W-test is rejected), there is a probability of $1 - \alpha_0$ that the corresponding observation indeed holds an outlier. On the other hand there is a probability α_0 that the observation does not hold an outlier, which means the rejection is unjustified. In geodesy values for α_0 between 0.001 and 0.05 are most commonly chosen. The table below presents an overview of the α_0 -values and the corresponding critical values. The actual choice depends on how strict and rigid we want to test the observations. A very strict testing (a small critical value), will lead to a larger α_0 and consequently an increasing probability of rejection of valid observations. An $\alpha_0 = 0.001$ means one false rejection in every 1000 observations. This has proven to be a workable choice in practice.

sign. level α_0	0.001	0.010	0.050
critical value W-test	3.29	2.58	1.96

Significance level/critical value overview

Essential for the B-method of testing is that an outlier is detected with the same probability by both the F-test and the W-test. For this purpose the power β of both tests is fixed on a level of usually 0.80. The level of significance α_0 of the W-test is also fixed, which leaves the level of significance α of the F-test to be determined. Having α_0 and β fixed, α depends strongly on the redundancy in the network. For large scale networks with many observations and a considerable amount of redundancy, it is difficult for the F-test to react on a single outlier. The F-test, being an overall model test, is not sensitive enough for this task. As a consequence of the link between the F-test and the W-test by which the power is forced at 0.80, the level of significance α of the F-test will increase. Considering the above, it is common practice to always carry out the datasnooping, no matter the outcome of the F-test.

During the datasnooping, each individual observation is tested through a conventional alternative hypothesis. However, as mentioned before, other alternative hypotheses can be formulated as well. A special hypothesis has been implemented, in order to trace **antenna height errors** in GPS baselines. The hypothesis is based on the fact that the direction of an antenna height error will coincide with the direction of the local vertical. The antenna height W-test has proven to be a very efficient tool, for instance in tracing 10 cm antenna height reading errors.

T-Test

As discussed in [W-Test](#), the W-test is a 1-dimensional test which checks the conventional alternative hypotheses. These hypotheses assume that there is just one observation erroneous at the time. This so-called datasnopping works very well for single observations, e.g. directions, distances, zenith angles, azimuths and height differences. However, for some observations such as GPS baselines, it is not enough to test the DX-, DY-, DZ-elements of the vector separately. It is imperative to test the baseline as a whole as well.

For this purpose the T-test is introduced. Depending on the dimension of the quantity to be tested, the T-test is a 3- or 2-dimensional test. As with the W-test, the T-test is also linked to the F-test by the B-method of testing. The T-test has the same power as both other tests, but has its own level of significance and its own critical value (see tables below).

sign level α_0	0.001	0.010	0.050
sign. level α (2 dim)	0.003	0.022	0.089
critical value T-test	5.91	3.81	2.42

Overview of significance level/critical value for 2 dimensional T-test, based on α_0 of W-test

sign level α_0	0.001	0.010	0.050
sign. level α (3 dim)	0.005	0.037	0.129
critical value T-test	4.24	2.83	1.89

Overview of significance level/critical value for 3 dimensional T-test, based on α_0 of W-test

The T-test is equally useful when testing known stations. The datasnopping will test for an outlier due to, e.g. a typing error, in either the X East, **or** Y North, **or** h-coordinate. The deformation of a station might not be detected by the datasnopping when the deformation-shifts decomposed in X East, Y North, and h-direction are relatively small. For the testing of a possible deformation influencing both the X East, **and** Y North, **and** h-coordinate a different alternative hypothesis is needed. The 3-dimensional T-test on the complete coordinate triplet is better equipped to trace the deformation, although it will not be able to trace the exact direction in which the station has moved.

Note: The situation in which the W-test is accepted, and the associated T-test of the observation is rejected, which is not unlikely in practice, does not imply a contradiction. It is simply a matter of testing different hypotheses.

Antenna Height-test

During the datasnoping, each individual observation is tested through a conventional alternative hypothesis. However other alternative hypotheses can be formulated as well. In the Adjustment a special hypothesis is implemented, in order to trace **antenna height errors** in GPS baselines. The hypothesis is based on the fact that the direction of an antenna height error will coincide with the direction of the local vertical. The antenna height W-test has proven to be a very efficient tool, for instance in tracing 10 cm antenna height errors.

The antenna height test is always computed if GPS-baselines are used. The test consists of three **W-test** computations:

- East-component
- North-component
- Height-component

The antenna height is only rejected if the height –component is rejected and the northing- and easting-component are accepted.

Interpreting Test Results

When dealing with testing results we always have to keep in mind that a certain amount of probability is involved in the process, and that there is no 'absolute truth'. Statistics in general should be used with discretion, i.e. in conjunction with common sense, practical experience and external independent evidence.

As discussed in the **F-test** explanation a rejection of the F-test, meaning a rejection of H_0 , could be due to:

- gross errors or blunders;
- an incorrect mathematical model;
- an incorrect stochastic model.

The fact that also a combination of these rejection sources is possible, makes it difficult to give any strict rules for drawing conclusions from the F-test value. In general, a rejected F-test in combination with a pattern of rejected W-tests points to a model error. An incidental W-test rejection points to one or more gross errors or blunders.

Since the F-test, W-test and T-test are linked, it is best to interpret both tests combined:

- A rejected F-test in combination with a limited number of W-test (T-test) rejections usually points to one or more gross errors.
- If the F-test is rejected and all observations of a specific type (e.g. all zenith angles) are rejected as well, the problem could be the mathematical model which needs correction or refinement. For instance, if all W-tests for the zenith angles are rejected, it may be useful to include refraction coefficients.
- If the F-test is rejected as well as most of the W-test values (without extremes), the problem could be the stochastic model. The input standard deviations are then too optimistic. On the other hand, if the F-test value is well below the critical value, and the W-test (T-test) values are all close to zero, the input standard deviations could be too pessimistic.

Suppose that the dataspooing on the observations in a network has resulted in a (limited) number of rejections. It is assumed that the rejections are not caused by mathematical model errors, and that obvious errors such as typing mistakes have been fixed. This leaves a number of options:

- **Remove the corresponding observation.** This is a valid but rather abrupt way of handling rejections. Remember that the removal of observations decreases the redundancy, and therefore influences precision and reliability.
- **Remeasure the corresponding observation.** Remeasuring observations is an obvious but often expensive way to eliminate rejections, especially when the fieldwork is already completed. It is therefore recommended to process as much of the data as possible on the site.
- **Increase the standard deviation of the corresponding observations.** Increasing the standard deviation of an observation will always work, meaning that it will always result in lowering the F-, W-, T-test values. However, one should keep in mind that the goal is not to get all tests accepted, but rather to detect blunders or model errors.
- **Ignore the rejections.** This option is obviously very risky and is only applicable in case the W-test values just exceed the critical value. It is useful to look at the estimate of the error involved with the rejection, and to see whether it is acceptable or not. We also have to remember that, depending on the level of significance, there is always a probability of rejecting a valid observation.

It must be stressed that an observation must never be edited in order to make it better fit in with the other observations of the network, unless there is clear evidence of the source of the errors, e.g. a typing error.

Estimated Errors

The size of the error responsible for the rejection of an observation or known coordinate is estimated by Design and Adjustment. This so-called estimated error is a useful tool, but should be handled with care:

- Only the estimated error associated with the largest W-test or T-test should be considered.
- As far as the W-test is concerned, the estimated error is based on the conventional alternative hypothesis that just one observation or known coordinate contains an error. Consequently if more errors are present in the network the result of the estimation could be meaningless, unless errors have been made (geographically) far apart.
- As far as the T-test is concerned, the estimated error is based on the hypothesis that just one GPS baseline or known station contains an error. Consequently if more errors are present in the network the result of the estimation could be meaningless, unless errors have been made (geographically) far apart. The test results and estimated errors are only meaningful when observational errors have been filtered out in the foregoing free adjustment and testing phase.

Points

Points View

The Points View enables you to display a list of all available points within a Project. The Points are displayed in a user configurable [Report View](#).

- The Points View may be accessed via the  **Points** Tab from within an open Project.
Alternatively: The Points View may be displayed upon selecting **Points** in the Tree-View of the Project Management.

Select from the Index to learn more about the Points View:

[Add New Points](#)

[Activate / De-activate Points](#)

[Delete Points/ Triplets](#)

[Assign points to a surface](#)

[Modify Point items](#)

[Save As](#)

[Send To](#)

[Shift/ Rotate/ Scale](#)

[Exchange Coordinate System \(Smart Station\)](#)

[Update Reference Triplet](#)

[Rename Tool](#)

[Point Editor](#)

[Point Properties](#)

[Configure the Points View](#)

[Move / Copy Points](#)

[Notes about Drag and Drop \(Copy & Paste\) points](#)

Configure the Points View

The **Points View** can be configured such that you can decide which kind of coordinate representation you want to see and which items of Quality information shall be listed.

In the Points View you may switch between the coordinate system (*WGS84* or *Local*) and you may switch between the coordinate type (*Cartesian*, *Geodetic* or *Grid*) to be displayed.

The graphical views **View/ Edit** and **Adjustment** also offer the possibility to switch between the *WGS84* coordinate system and a *Local* coordinate system. The coordinate type is fixed to *WGS84 Geodetic* or *Local Grid* in the graphical views.

Select the Coordinate System

- In the **View** main menu or the **Coordinate Format** Toolbar select between  *WGS84* and  *Local*, or right-click on a column heading, select **Coord. System** and choose a system from the list.



Alternatively: Use **Ctrl-W** or **Ctrl-G** to switch from *WGS84* to *Local*.

To be able to switch between the *WGS84* and *Local* coordinates of a point, a Coordinate System defining the parameters for the conversion must be attached to the Project.

Note: You can switch the Points view also if the conversion is not possible and even if no Coordinate System is attached. Points which cannot be converted will not be displayed in this case.

Tip: To see all points in the Coordinate System in which they are stored to the database, select Coordinate System and then **As Stored** from the **View** main menu.

Select the Coordinate Type

- In the **View** main menu or the **Coordinate Format** Toolbar select between  *Cartesian*,  *Geodetic* and  *Grid*, or right-click on a column heading, select **Coord. Type** and choose a type from the list.

To be able to switch between the *Cartesian*, *Geodetic* and *Grid* coordinates of a point a Coordinate System defining the parameters for the conversion must be attached to the Project. Note that *Grid* is only possible if the Coordinate System is *Local*.

Note: You can switch the Points view also if the conversion is not possible and even if no Coordinate System is attached. Points which cannot be converted will not be displayed in this case.

Tip: To see all points in the Coordinate Type in which they are stored to the database, select Coordinate Type and then **As Stored** from the **View** main menu.

Select the Coordinate Quality

- In the Report-View of **Points** right-click on a column heading and select **Coord. Quality**. Select the coordinate quality items that shall be displayed :

Standard Deviations, *Var-covariance elements* and/or *Quality*.

Configure the columns

- Right-click on the column heading and select **Columns...** In the Columns dialog configure
 - which columns you want to see (via the check-boxes or via the **Show/ Hide** buttons).
 - the column order (via the **Move up/ Move down** buttons).
 - the column width (in pixels).

Click **Reset** to restore the original settings.

Related topics:

[Report-View](#)

Add a New Point to the Points View

1. From the Context-Menu (right-click) select **New....**
2. Enter a unique **Point Id**.
3. Change **Point Class and Subclass** if necessary.
4. Select the **Coordinate Type** and **Format**. Additionally, if you add a new point to a Project select between **WGS84** and **Local** coordinates.
5. If the coordinate format includes height, select between **Ellipsoidal** and **Orthometric** height.
6. Enter the Point **Coordinates** and if necessary **Geoid Separation**.
7. Enter the **Standard deviations** (optional).

Note: To toggle between **standard deviations** and **quality** information right-click in the background of the page.

8. Press **OK** to confirm or **Cancel** to abort the function.

Point Properties

Point Properties (Points View)

This Property-Sheet enables you to display and/or modify the point properties.

1. Right-click on a point in the Report-View and select **Properties**.

Use the tabs to switch between the following pages:

General

Stochastics

Thematical Data

Reliability (available only if the reliability has been previously calculated using the Adjustment component)

Mean (available only if more than one coordinate triplet of class *Measured* for a particular point exists)

Images (available only if at least one image is linked to the selected point)

Hidden Point functionality is only available for **GPS** measurements. **Hidden Point Properties** can only be displayed in the **View/ Edit** component or in the **Points View** of LGO:

Hidden Point (Position) (available only if the selected point is a Hidden Point)

Hidden Point (Height) (available only if the Hidden Point has height properties attached)

2. Make your changes.

Note: Only the fields with white background may be edited at that particular instant.

3. Press **OK** to confirm or **Cancel** to abort the function.

Note:

- This Property-Sheet does not list all possible point properties. All point properties at once may be displayed in the Report-View only. Please refer to [Point Properties: All](#) for a complete description of all point properties.

Point Properties: All

Point Id

Point Identification

Point Class

Indicates the hierarchical position of a coordinate triplet for a point. For a complete listing of all Point Classes refer to [Point \(Coordinate\) Classes and Subclasses](#). When working with pure Level data only a limited number of Point Classes is of relevance. In this case refer to [Point Classes and Subclasses \(Level\)](#).

Point Subclass

Certain Point Classes may have a Subclasses defined e.g. to describe the source of the coordinate triplet.

Date / Time

Date and Time the point triplet was created.

Coordinate Type

Displays the coordinate representation type: *Cartesian*, *Geodetic* or *Grid*. Additionally it allows you to alternate between *WGS84* and *Local* coordinate system.

Coordinate Format

Coordinate representations of the selected coordinate type:

- Cartesian: *X, Y, Z*

- Geodetic:

Latitude, Longitude
Latitude, Longitude, Height
Height

- Grid (only available if the Coordinate System is set to *Local*):

Easting, Northing
Easting, Northing, Height
Height

Geoid Separations are available in all Coordinate Formats if the Coordinate System is set to *Local*.

Coordinate Source X,Y / Coordinate Source Z

Refers to the source as to how the coordinate triplet was created. The Coordinate Source is displayed separately for the position and height component.

X,Y,Z or Lat., Long., Height or Easting, Northing, Height

Values for the point coordinate triplets. The format depends on the Coordinate Type.

Geoid Sep.

The Geoid Separation is the difference between ellipsoidal and orthometric height

Coding Columns

The Coding Columns **Code Group**, **Code**, **Description** and **Attributes** enable you to get an overview of the Thematical coding which has been attached to points. Due to the relationships between the data in these columns, the data fields for these columns are read-only, i.e. they cannot be **modified**. As default, these columns are hidden.

The **Attributes** column may contain more than one attribute for a point. In this case the single attributes are delimited by a forward slash. The specific values are assigned to the single attributes with the help of the equals sign.

Annotations

Displays all annotations that have been recorded on this point in the field. Note that for each occupation

interval up to 4 annotations can be entered on the field system. In the office software these annotations are delimited by a forward slash.

M0, Q11-Q33

Elements of the Variance – Covariance Matrix of the coordinate triplet.

Sd. X (Lat., East.)

Standard deviation: $Sd_{(X, Lat., East.)} = M_0 \cdot \sqrt{Q_{11}}$

Sd. Y (Long., North.)

Standard deviation: $Sd_{(Y, Long., North.)} = M_0 \cdot \sqrt{Q_{22}}$

Sd. Z (Height)

Standard deviation: $Sd_{(Z, Height)} = M_0 \cdot \sqrt{Q_{33}}$

Posn. Qlty

Position Quality: $Posn. Qlty = M_0 \cdot \sqrt{Q_{11} + Q_{22}}$

Hgt. Qlty

Height Quality: $Hgt. Qlty = M_0 \cdot \sqrt{Q_{33}}$

Posn. + Hgt. Qlty

Position and Height Quality: $Pos. + Hgt. Qlty = M_0 \cdot \sqrt{Q_{11} + Q_{22} + Q_{33}}$

Semi-major (a) / Semi-minor (b) / Orientation (Phi)

Elements of the error ellipse.

Sd. Height

Standard deviation of the height as an equivalent to the error ellipse.

Reliability (E-W) / Reliability (N-S) / Reliability Height

The absolute Reliability is derived using the optional Design and Adjustment module. The elements are split up in a East-West, North-South and Height component.

Averaging Limit Column

With the help of this indicator you may -if desired- get an overview of all points exceeding the averaging limit. To group all these points together you may make use of the **sort functionality**. Deactivating all those points may serve as an **export filter**.

The principle is that **all** measured triplets will be considered to decide whether the limit has been exceeded, regardless of their **Use**-status. If one or more triplets exceed the limit, the point is flagged. The **averaging limit indicator** is displayed regardless of whether the current triplet is of class **Average**.

Any time you associate different triplets with a point or you change the averaging limit of the project the **Averaging Limit**-status will be updated.

Point Properties: General

This Property-Page enables you to display/ edit General Point Properties.

Point Id

Point Identification

Point Class

Indicates the hierarchical position of a coordinate triplet for a point. The currently selected point class is active for the selected point. It may be changed to any of the other classes that are available for the selected point.

For a complete list of all Point Classes refer to [Coordinate \(Point\) Classes and Subclasses](#).

Point Subclass

Certain Point Classes may have a Subclasses defined e.g. to describe the source of the coordinate triplet.

Coordinate Type:

Displays the coordinate representation type: *Cartesian*, *Geodetic* or *Grid*. Additionally it allows you to alternate between *WGS84* and *Local* coordinate system.

Coordinate Format

Coordinate representations of the selected coordinate type:

- **Cartesian:** X, Y, Z
- **Geodetic:** Latitude, Longitude, Height
- **Grid:** Easting, Northing, Height (only available if the Coordinate System is set to *Local*)

Note: The order of *Easting* and *Northing* depends on the coordinate order set under [Tools - Options: Units/Display](#).

The Geoid separation is the difference between ellipsoidal and orthometric height. Geoid Separations can be added to all Coordinate Formats if the Coordinate System is set to *Local*.

Note: This input field is only visible if the Coordinate Format includes a Geoid Separation.

Height Mode:

If the Coordinate System is set to *Local*, height values may be displayed as follows:

- *Ellipsoidal* Heights above the Ellipsoid
- *Orthometric* Heights above mean sea level



The **values** of the point coordinate triplets are displayed depending on whether *Cartesian*, *Geodetic* or *Grid* has been chosen as **Coordinate Type**.

The **standard deviation** is listed to the right of each coordinate value. The standard deviations are derived from the elements of the variance – covariance matrix as follows:

$$\begin{aligned}
 Sd_{(X, Lat, North)} &= M_0 \cdot \sqrt{Q_{11}} \\
 Sd_{(Y, Lon, East)} &= M_0 \cdot \sqrt{Q_{22}} \\
 Sd_{(Z, Height)} &= M_0 \cdot \sqrt{Q_{33}}
 \end{aligned}$$

Tip: Right-click in the background of the General page to display the Coordinate Quality instead of Standard Deviations and vice versa.

In case a **Reference point** has been selected for display, the coordinate triplet is editable. Subsequently, all GPS rover coordinates and all TPS target coordinates computed with respect to modified reference coordinates will be shifted by the same amount as the reference coordinate triplet itself. In case GPS and TPS observations are connected to the same reference then a coordinate system must be attached to the project to be able to convert the amount of the shift from *WGS84* to *Local Grid*.

The complete coordinate triplet can be **copied**  to the clipboard and subsequently **pasted**  into another triplet of the same or of a different point. Use the corresponding buttons in the lower left corner of the **Point Properties: General** page.

Note: Paste is only allowed if the coordinate type and system matches and if the triplet is editable.

Point Properties: Stochastics

This Property-Page enables you to display/edit the stochastic information of a point that refer to the point accuracy.

M0, Q11-Q33

Elements of the upper triangle of the variance - covariance matrix

Semi-major (a)

Semi-major axis of the error ellipse

Semi-minor (b)

Semi-minor axis of the error ellipse

Orientation (Phi)

Orientation of the semi-major axis

Sd. Height

Standard deviation of the height as an equivalent to the error ellipse.

Point Properties: Thematical Data

This Property-Page enables you to display/edit the attached Thematical Coding information of a point. Thematical Coding information is only available if a Codelist is attached to the project. If Thematical Codes have been used in the field for data collection a Codelist is automatically transferred to the project during data import.

Note:

- If you change the thematical code of a point you can only select Codes that are defined in the Codelist. To create new Codes and Code Groups use the [Codelist Tab](#).
- The thematical code of a point can also be changed via in-line editing in the **Points View** or in the [Observations View](#) in the **View/ Edit** or the **Adjustment** component. Only Codes that are defined in the Codelist of the active project are available for selection.
- Codes may also be changed **for a multiple selection** of points. On how to proceed in this case refer to the topic: [Modifying Point Codes](#).

Point Id:

Shows the point identification as read-only.

Code Group:

Shows the attached Code Group. To change select a different Code Group from the list.

Code:

Shows the attached Code. To change select a different Code from the list.

Description:

Shows the Description of the Code as read-only.

Attributes:

Lists the Attributes of the attached Code.

Type:

Shows the Attribute Type depending on which item is selected under Attributes. The following types are possible: **String**, **Integer** or **Real**

Value:

Shows the value of the Attribute. To change enter a new value or choose a value from the list. Press **Erase** to delete the value.

Note: If the Attribute is set to *fixed* the default value is shown and the value can not be changed.

Point Properties: Reliability

This Property-Page displays the external reliability rectangle of a point. The external reliability can be defined as the largest effect of an undetected error on a coordinate component due to a connected observation. See also [All about Adjustment: Reliability](#).

The reliability is available only if a point has been adjusted using the adjustment component and has been determined by at least two independent measurements.

E-W: Reliability in East-West direction (Longitude)

N-S: Reliability in North-South direction (Latitude)

Height: Reliability in Height

Point Properties: Mean

If point coordinates are determined by two or more measurements, the software automatically takes the mean (average) of all solutions (*Measured* coordinate triplets). This Property-Page enables you to display all *Measured* coordinate triplets for a point and their differences to the mean.

Note:

- This Property-Page is only available if more than one measurement exists for a particular point.

Point Id:

Point Identification

Averaging Limit:

Defines the maximum distance limit within which a coordinate triplet is automatically used to calculate a mean (average). This limit can be set via Project Management under [Project Properties: General](#).

Note: A solution has to comply with both limits (*Position* and *Height*) to be automatically averaged.

Current Mean Coordinates:

Displays the coordinates of the selected point and the Coordinate Quality (CQ).

List box:

Lists all *Measured* coordinate triplets for a point and the differences in position and height to the mean.

Measurements that exceed the Averaging Limit are marked with  in the **Use** column.

You may also manually accept or reject measurements for Mean calculation.

Computed Coordinates:

Displays the number of coordinate triplets that exceed the averaging limit and the mean (averaged) coordinates based upon the current selection in the *Use* column.

Tip:

- A summary of all points with mean coordinates is available in the [Mean Coordinates and Differences Report](#).

Related topics:

How to activate/ de-activate measurements for Mean calculation

Point, Line/Area, Setup Properties: Images

In this Property-Page all images linked to the selected **Point** or **Line/Area** or **TPS Setup** are given in an embedded thumbnail view together with the filename of each image and the date and time when the picture has been taken.

Note:

- This Property-Page is only available if there are images linked to the selected object.

If more than one image is linked to the selected object you may adjust the size of the thumbnails in the embedded view to be able to see more than one thumbnail at a time.

When you select an image a context menu is available from which you may choose to Open the image in the Windows default viewer or to Open the containing folder.

The Delete and Unlink functionality is available for a selection of one or more images.

Point Properties: Hidden Points

Hidden Points are points that cannot be measured by GPS due to satellite shading, which may be caused by trees overhead, the close proximity of buildings etc.

Nevertheless, such points can be captured by using one of the following methods with System 500 and GIS System 50 sensors:

- **Bearing and Distance**
- **Double Bearing**
- **Double Distance**
- **Chainage and Offset**

Note: For further description of these methods see the [Technical Reference Manual](#).

Depending on whether height information is attached to the Hidden Point the point property sheet offers you one or two additional pages:

- [Hidden Point \(Position\)](#) and/ or
- [Hidden Point \(Height\)](#)

Both are designed to enable editing and subsequent re-calculation.

Hidden Point (Position)

When **Hidden Points** have been measured and imported to LGO you will be offered one or two additional pages on the corresponding **Point Properties** pages. The **Position page** will always be available for points of subclass **Hidden**.

If a point has been measured twice or more as a **Hidden Point** you may select single intervals from the combo box at the top of this page.

Method:

Each **Hidden Point** must have been measured using one of the following techniques:

- **Bearing and Distance**
- **Double Bearing**
- **Double Distance**
- **Chainage and Offset**

The method will be indicated to you in this combo box.

Note: For further description of the above mentioned methods see the [Technical Reference Manual](#).

Posn. measurement qty:

Here you are presented with the Position Quality of the **Hidden Point** as it has been configured on the sensor in the field. It may be edited in this box for each point.

Depending on the method the following Hidden Point parameters are displayed and may be edited:

Bearing and Distance:

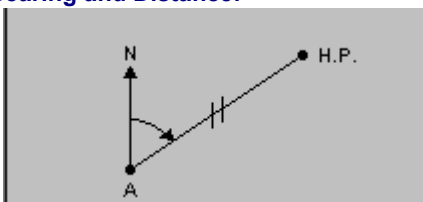

Editable elements:

Auxiliary point A
Bearing
Distance

Double Bearing:

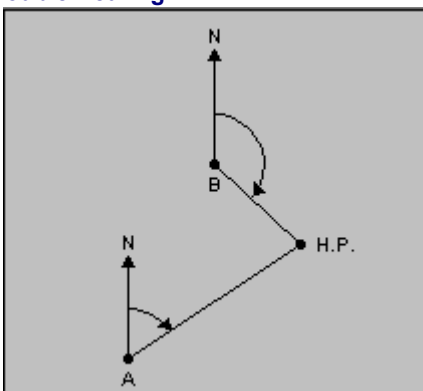

Editable elements:

Auxiliary point A
Bearing (A)
Auxiliary point B
Bearing (B)

Double Distance:

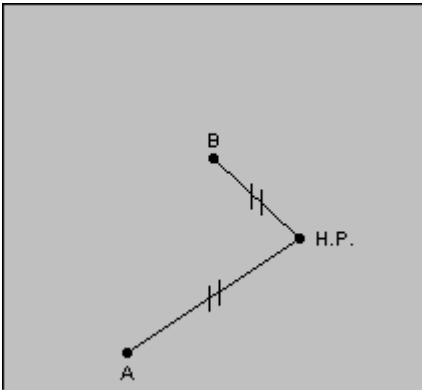

Editable elements:

- Auxiliary point A
- Distance (A)
- Auxiliary point B
- Distance (B)
- Point is to the (left or right)

Chainage and Offset:

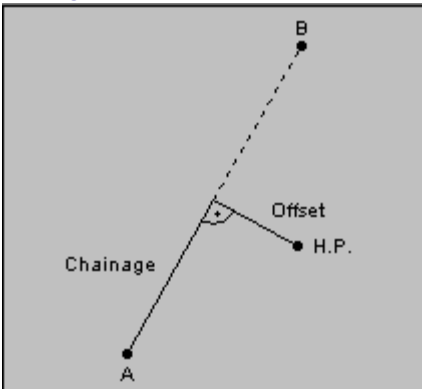

Editable elements:

- Auxiliary point A
- Auxiliary point B
- Chainage
- Offset
- Point is to the (left or right)

If you want the chainage to be reverted check **Chainage from Auxiliary point B to Auxiliary point A.**

Hidden Point (Height)

This page will only be available if the **Hidden Point** has height properties attached.

Method:

The height of a Hidden Point may have been derived by either applying the height difference measurement on only one auxiliary point or by applying the mean height difference derived from measurements on two auxiliary points or by applying a height difference derived from a slope distance and elevation angle measurement on an auxiliary point. No matter which method has been applied, it will always be read-only and is not editable. The following three methods are available:

- Height difference
- Height difference mean
- Slope distance and elevation angle

Hgt. measurement qlty:

Here you are presented with the Height Quality of the **Hidden Point** as it has been configured on the instrument in the field. It may be edited in this edit field for each point.

Depending on whether the height has been determined as an average or not, you will be presented with either the height measurement based upon auxiliary point A **or** B or with height measurements on A **and** B. In both cases the functionality for the edit fields and combo boxes described below is the same.

Auxiliary point A/ B:

Select the auxiliary point from which the height of the hidden point shall be derived. You may choose between the auxiliary points used in the [position calculation](#).

Height of auxiliary point A/ B:

The WGS84 height of the selected auxiliary point is indicated to you.

Height difference from auxiliary A/ B (Height difference methods):

Here you can edit the height difference(s) between the selected auxiliary point(s) and the **Hidden Point**.

Slope distance/ Elevation angle (Slope distance and elevation angle method):

Here you can edit the slope distance and elevation angle measured on the auxiliary point to the **Hidden Point**. Changes result in a different height difference being calculated and applied.

Difference in the two solutions:



If an average height has been calculated for the Hidden Point, then the difference between the two height solutions from which the average has been calculated will be indicated to you.

Point Editor

The Point Editor is a spreadsheet style window which allows you to easily enter and/ or edit local grid coordinates for existing or new points in an LGO project.

To be able to open the Point Editor the coordinates in your project either have to be stored as local grid or a coordinate system has to be attached for WGS84 data.

To invoke the Point Editor:

1. In  **View/ Edit** or in the  **Points** view switch the view to **Local Grid** in the **Coordinate Format** toolbar.
2. Right-click into the view's background to invoke the Point Editor with an empty spreadsheet. If one or more points are selected these will already be entered into the spreadsheet when the Point Editor is opened.

Alternatively, select  **Open Point Editor** from the **View/ Edit** or the **Points** main menu or from the **toolbar**.

3. Leave the Point Editor with **OK** to take your entries and/ or changes over into the active project.

The following point information is shown in the Point Editor:

Point Id:

The Id(s) of the selected point(s) are shown and may be edited. Ids for new points may be entered.

Point Class:

The current class of the selected point(s) is displayed but cannot be modified. The class of newly entered points is always *Control*.

Easting, Northing, Ortho. Height:

The local grid coordinates of the selected point(s) are displayed. If the **Point Class** is *Control* the coordinates may be edited. The coordinates for new points may be entered. The coordinate order will be as set under **Tools-Options: Units/Display**.

Code, Code Group:

If the selected point(s) have a code attached it will be displayed as well as the code group it belongs to. Codes and Code Group may always be changed or newly entered. Select a code from the drop-down list (slow double-click) or enter a new code. You may either select a code group for newly entered codes or the new codes will be inserted into the Default code group automatically.

Note:

- The Point Editor opens by default with a limited number of lines displayed for entering data. To extend the list simply click ENTER after you have completed the last line and a new line will be added automatically.
- The columns may be arranged and configured as in any of the **report views** including sorting, moving, hiding and viewing and a resetting the configuration.

Modifying Point Items

Enables in-line editing of selected items.

1. Right-click on the item to be edited and select **Modify...** from the context menu.
Alternatively: Double-click slowly onto an item.
2. Change the value or select a value/ property from the list.
3. Click **Enter** to confirm or **Esc** to abort the function.

Note:

- Only items that are allowed to be modified at the particular time or instant are active.

For detailed information on special items see also:

[Modifying Point Classes](#)

[Modifying Point Codes](#)

Modifying Point Codes

In the **Points View** and in the **Observations View** the thematical point code can be changed for single points or a multiple selection of points.

For **single** points the code can be changed either via the **Point Properties: Thematical Data** property-page or via **in-line editing**.

If the code(s) for **more than one** point shall be changed simultaneously:

1. Select the points for which the code shall be changed.
2. Right-click into the selection and select **Edit Thematical Data...** from the context menu. In the **Observations View** select **Edit Target/ Rover Point Code...** from the context menu.

In this dialog:

3. Select a Code from the same or another Code Group. All point codes that are available in the Codelist of the active project will be offered for selection.
4. Leave the dialog with **OK** to apply the selected Code Group, Code and Code Description to all points included in the selection.

Note: Attribute values which might have been defined for the selected point(s) are removed when changing the code. They would have to be re-defined for each point in the **Point Properties: Thematical data** dialog page if desired.

Modifying Point Classes in the Points View

In the **Points View** the point class can be changed for single points or a multiple selection of points.

For **single** points the class can be changed either in the **General** page of the **Point Properties** dialog or via **in-line editing**.

If the class shall be changed for **more than one** point simultaneously:

1. Select the points for which the class shall be changed.
2. Right-click into the selection and select **Change current Point Class...** from the context menu. From the sub-menu that pops up then select the point class to be applied to the selection.

Note:

- If for one or more points in a selected set of points the selected point class **does not exist** then the current class will not be changed for this or these specific point(s).

For example, if in a set of *Control* points there is one point that has class *Averaged* lying underneath and if for the whole set the class shall be changed to *Measured*, then for all points **except** the one point that also has class *Averaged* the Point class shall be changed to *Measured*. The one point with class *Averaged* underneath will remain unchanged because for averaged points class *Measured* is not unique.

Point (Coordinate) Classes and Subclasses

The coordinate class describes the type and/or source of a coordinate triplet. For each point there may exist more than one coordinate triplet in the Office database.

The coordinate classes represent the hierarchical order of the coordinate triplets. The **Points View** displays the active coordinate triplet for each point. By default the triplet with the highest class is active.

E.g. if you import GPS raw data, the points are imported with *Navigated* coordinate triplets attached. After processing the baseline a coordinate triplet *Measured* is added to the point. After processing another baseline for the same point another coordinate triplet *Measured* is added and an average is calculated. The average calculation adds another coordinate triplet of class *Average* to the point. Later the point is used in an Adjustment which adds the adjusted coordinates as a coordinate triplet of class *Adjusted* to the point and so on.

The point subclass on the other hand gives an indication to the user as to the source from which the coordinate came.

The following list represents the Coordinate Classes in the ascending hierarchical order:

<u>Symb</u>	<u>Class Id</u>	<u>Description</u>
+	Estimated	<p>This coordinate class is required to support the Adjustment component when terrestrial observations are involved. Before an adjustment can begin, provisional (<i>estimated</i>) coordinates are required for each point.</p> <p>The subclass of <i>Estimated</i> is always None.</p>
□	Navigated	<p>Navigated coordinates derived using the uncorrected Code solution of a single epoch. E.g. points that are imported via GPS data import and that have not yet been post-processed are awarded point class <i>Navigated</i>.</p> <p>The subclass of <i>Navigated</i> is always Code only</p>
⊗	Single point position	<p>Coordinates derived using the Single Point Positioning (SPP) processing of the GPS-Processing kernel or a GPS receiver.</p> <p>The subclass of <i>Single point Position</i> is always Code only</p>
⊙	Measured	<p>Coordinates that have been differentially corrected using GPS post-processing or Real-time are awarded this point class. Target points of TPS observations will also have coordinate class <i>Measured</i>.</p> <p>Note that only the class <i>Measured</i> can hold more than one coordinate triplet. If more than one coordinate triplet for one point exists, the different coordinate triplets are automatically averaged and the point is awarded the point class <i>Average</i>.</p> <p>Depending on the source of the coordinate triplet, the point may have the following subclasses:</p> <ul style="list-style-type: none"> - Code Only Code only solution from post-processing - Phase Fixed Phase solution from post-processing - Phase Phase solution from RTK - None Target point of a TPS observation - Hidden Calculated solution for a Hidden Point - (Aux) With this suffix the auxiliary points for Hidden Points will be marked.
⊕	Averaged	<p>Averaged coordinates of points for which two or more measurements exist. Averaging algorithms exist in the office software as well as on the sensor.</p> <p>Note: Measured triplets stored in different coordinate systems (WGS84 or Local) or coordinate types (Cartesian, Geodetic or Grid) can also be averaged if the attached coordinate system allows the conversion.</p> <p>The subclass of <i>Averaged</i> is always None.</p>
▽	Reference	<p>For points that have been used as a Reference for GPS Post-Processing or</p>

GPS Real-Time, a coordinate triplet of class *Reference* will be added. Such GPS Reference triplets will always be stored in the WGS84 coordinate system.

Point class *Reference* is also used for points which are associated with a setup which has connected TPS or Level observations in Adjustment.

Note: Only one Reference triplet can exist for anyone point.



Adjusted

Coordinates that have been adjusted using the Adjustment program.

Note: Since GPS Hidden Points do not take part in the Adjustment they will not be awarded point class Adjusted afterwards even though subsequently their coordinates might have changed. Thus, when you want to export e.g. all adjusted points, be aware that you have to export the Hidden Points separately.



Control

Coordinates of class *Control* primarily serve as fixed coordinates for the network adjustment. It is the highest point class and should be used if you enter Coordinates manually. Depending on whether they are fixed in position, fixed in height or both, they may have different subclasses and will be represented by different symbols:

 **Fixed in Position and Height**

 **Fixed in Position**

 **Fixed in Height**

Note:

- Coordinates that are manually entered may be awarded either the point class **Estimated** or **Control** only.

Tip:

- On how to copy and paste triplets easily refer to: [Copy and Paste triplets in the Point Properties: General page](#).

Point Classes and Subclasses (Level)

The **point class** describes the type and/or source of a point height. For each point there may exist more than one height in the LGO database.

The point classes represent the hierarchical order of a point's heights. The **Points View** displays the currently active point class for each point. By default the height with the highest class is active.

The point class in the **booking sheet** is independent of the currently active point class in the Points View. In the booking sheet the only two point classes to be displayed are *Measured* and *Control*. Other classes like for example *Averaged* may only be displayed in the Points View.

See also: [Changing Point Classes in the Booking Sheet](#)

The **point subclass** supplies additional information relevant to the individual class. The subclass indicates to the user the source the height came from.

The following list shows the Point Classes in ascending hierarchical order:

<u>Class Id</u>	<u>Description</u>
Measured	<p>Class of heights that have either been calculated by the Level instrument while the Level line was measured or that have been processed in LGO.</p> <p>Measured point heights can be modified in the booking sheet. Accordingly, all measured heights in the level line will be shifted by the same amount.</p> <p>Depending on the source of the measured height a point of this class may have the following subclasses:</p> <ul style="list-style-type: none"> - None: if the height is the measured raw height as it has been imported from the level instrument via Raw Data Import. - (Level) Processed: if the point has a height resulting from a processing run in LGO. <p>Note: <i>Measured</i> is the only point class which can comprise more than one height coordinate. If more than one measured height exists for a point the average will automatically be calculated. Points with an averaged height coordinate are awarded the additional class <i>Averaged</i>.</p>
Averaged	<p>Class of points for which more than one height of class <i>Measured</i> exists. The subclass of <i>Averaged</i> is always <i>None</i>.</p>
Control	<p>To process a level line in LGO at least one point must be of class <i>Control</i>. Control heights are retained in a processing run. They serve as the basis relative to which all other points are computed.</p> <p>By default the first point in a level line will be set to class <i>Control</i> when importing level raw data. It is assumed that the first point in a line has the known start height. To change the default and fix point heights manually in the booking sheet select Create Control from the context-menu.</p> <p>In level projects the subclass of <i>Control</i> points is <i>Fixed in Height</i>.</p> <p>Note: When you create a control you may fix the point's height to a different value than the measured height value. Changing the point height in creating a control does not simultaneously affect the heights of all other points. Neither the heights of all measured points in the line nor the heights of other controls will be shifted by the same amount.</p>

Activate / De-activate Points (Points View)

Allows you to **Activate** or **De-activate** Points of a Project manually. If a Point is deactivated it is still visible on the screen and stored in the Project database. When exporting points, de-activated points may be included via the **Settings** pages of the various **ASCII Export** types. De-activated Points are marked with a blank check box to the left of the Point Id.

Note: Additionally, de-activated points are not used in the optional adjustment component.

Activate:

- Highlight a de-activated Point and select **Activate** from the context menu or from the **Points** main menu.
or
Select a series of de-activated Points and select **Activate**.

De-activate:

- Highlight a de-activated Point and select **De-activate** from the context menu or from the **Points** main menu.
or
Select a series of Points and select **De-activate**.

Alternatively:

- Use the check box to the left of the Point Id to activate or deactivate points.
- Be aware that single points as well as groups of points may also be activated or de-activated with the help of **Filters**.

Delete Points/ Triplets (Points View)

Enables you to delete a coordinate class (coordinate triplet) of a point or to delete an entire point.

To delete a point:

1. Highlight a Point and select **Delete** and then **Points** from the context-menu or from the **Points** main menu.
2. Press **Yes** to confirm or **No** to exit without deleting.

Note:

- If you delete a Point, all coordinate triplets and all associated data including raw data will be deleted permanently from the database.

To delete point triplets:

To delete a particular coordinate class (coordinate triplet) of one or a series of points, highlight the point(s) to be deleted, go to **Delete** and then **Triplets** in the context-menu or the **Points** main menu and select an individual class from the list.

Note:

- If you delete the only coordinate triplet that exists for a point, the entire point will be deleted from the database.
- If you delete the *Averaged* point triplet, **all** *Measured* triplets will be deleted as well.

Tip:

- If you select a series of points all of them can be deleted at once.

Shift/ Rotate/ Scale

Shift/ Rotate/ Scale

The **Shift/ Rotate/ Scale** wizard enables you to transform a set of **grid** coordinates into new coordinates using a *Classical 2D Helmert* transformation for the **position** and a *shift* for the **height** component.

The **parameters** of the transformation can either:



- be entered manually
- be computed independently (by comparing a set of points)
- be derived from a rigorous Helmert transformation.

The transferred **grid** coordinates replace the existing **grid** coordinates of the selected points. If you want to keep the original grid coordinates, too, you should create a **backup** copy of your project first.

Note:

- Only coordinates stored as **local grid** can be transformed.
- You can be sure that setup and target points will only be transformed **together**. It is **not** possible to transform only the setup coordinates or only the target coordinates of TPS observations.

To invoke the wizard:

- Select the points to be transformed either graphically in the  **View/Edit** tabbed view or in the  **Points** view of your project and select **Shift/Rotate/Scale...** from the corresponding main menu or from the background menu.

Depending on the **method** that shall be used for calculating the shift, rotation and scaling parameters you will be guided through the following wizard pages:

Enter manually or calculate separately:

Shift/ Rotate/ Scale Wizard - Start

Shift/ Rotate/ Scale Wizard - Shift

Shift/ Rotate/ Scale Wizard - Rotation

Shift/ Rotate/ Scale Wizard - Scale

Shift/ Rotate/ Scale Wizard - Transformation parameters

Shift/ Rotate/ Scale Wizard - Finish Transformation

Calculate using Common Points:

Shift/ Rotate/ Scale Wizard - Start

Shift/ Rotate/ Scale Wizard - Transformation parameters

Shift/ Rotate/ Scale Wizard - Common Points

Shift/ Rotate/ Scale Wizard - Transformation parameters

Shift/ Rotate/ Scale Wizard - Finish Transformation

Tip:

- If you want to use **Filter Settings** to select the points, set the filter criteria as required and apply them to **activate** a subset of points. Afterwards select **Select checked items** from the **Points** context menu to **select** the active subset of points as input to the Shift/ Rotate/ Scale wizard.

Shift/ Rotate/ Scale Wizard - Start

In the **Start** page of the **Shift/ Rotate/ Scale** wizard you are presented with a list of all point triplets which will be affected by the transformation. The points are given together with their local grid coordinates in a configurable report view.

The list of points is based upon the selection of points as given in the **View/ Edit** or **Points** tabbed view when invoking the wizard. It is influenced, though, by some conditions which add or remove points to or from the list as follows:

- Only points stored with **Local Grid** coordinates are displayed. Point triplets which are **not** stored as Local Grid (but e.g. as WGS84) cannot and will not be transformed.
- The points must have position information to apply the 2D transformation. **Height-only** point triplets will only be shifted in height.
- Only Point classes **Estimated, Measured, Reference, Adjusted** and **Control** will be listed.
- Measured point triplets, **to which** an **observation** has been made, will be **removed** from the list, **if** the reference point (the TPS setup point) from which the observation has been made is **not included** in the selection **either**.
- If you have selected a **Reference** point triplet, then **all** connected measured point triplets will automatically be included in the list.
- If you have selected the **Start** point and the **End** point of a **level line**, then the measured point triplets of all turning points will also be included.

By this selection mechanism it is ensured that setup and target points are always **transformed together**. Inconsistencies are avoided.

You can decide on this wizard page which **method** shall be used for calculating the shift, rotation and scaling **parameters**.

- Select **Enter manually or calculate separately** if you want to either enter known parameters or calculate the parameters independently using points stored in the project.

Click **Next** to proceed to the [Shift/ Rotate/ Scale Wizard - Shift](#) page.

- Select **Calculate using Common Points** if you want to calculate the parameters for a Classical 2D Helmert transformation by matching common points. The **new** coordinates of the common points can be taken from any project.

Click **Next** to proceed to the [Shift/ Rotate/ Scale Wizard - Common Points](#) page.

Shift/ Rotate/ Scale Wizard - Shift

In this page you may determine the **Shift** parameters for the 2D-Helmert transformation and the shift in height.

Shift parameters:

Enter the shift parameters **dE**, **dN**, **dH** manually. If you want the shifts in Easting, Northing and Height to be calculated from two points in the project or from two manually entered sets of coordinates select

Calculate using Points.

The shift will be applied to all points listed in the [Start](#) page.

Calculate using Points:

Select two points between which the shift vector shall be calculated. From the drop-down lists you may select any point which is either stored in local grid or can be converted to local grid in the project. You can also enter Easting, Northing and Height manually.

The calculated differences in Easting, Northing and Height will be indicated as the shift parameters in the **dE**, **dN**, **dH** edit fields. The shift will be applied to all points listed in the [Start](#) page.

Click **Next** to proceed with the [Shift/ Rotate/ Scale Wizard - Rotation](#) page.

Shift/ Rotate/ Scale Wizard - Rotation

In this page you may determine the **Rotation** parameters for the 2D-Helmert transformation.

Rotation parameters:

Enter the rotation angle **Rz** manually. If you want the rotation to be calculated from points in the project select **Calculate using Points**.

Select an **Origin** for the rotation. Enter the Easting and Northing coordinates manually or select any point which is either stored in local grid or can be converted to local grid in the project from the drop-down list.

Based on the given Origin the rotation will be applied to all points listed in the [Start](#) page.

Calculate using points:

The rotation can be computed from the difference between two azimuth values. Enter the **old** and the **new azimuth** values manually or select two points from which the old and new azimuth shall be calculated. From the drop-down lists you may select any point which is either stored in local grid or can be converted to local grid in the project.

The rotation angle **Rz** is calculated as the difference between the two azimuth values (**new** minus **old**).

The calculated rotation angle will be indicated in the **Rz** edit field. Based on the given Origin the rotation will be applied to all points listed in the [Start](#) page.

Click **Next** to proceed with the [Shift/ Rotate/ Scale Wizard - Scale](#) page.

Shift/ Rotate/ Scale Wizard - Scale

In this page you may determine the **scale factor** for the 2D-Helmert transformation.

Scale factor:

Enter the scale factor manually.

If you want the scale factor to be calculated from two given distances select **Calculate using Distances**.

If you want the scale factor to be calculated from the distances between two pairs of points in the project select **Calculate using Points**.

Calculate using Distances:

Enter two distances (**old** and **new**) for the computation of the scale factor. The scale factor is derived by dividing the **new** by the **old** distance.

The calculated scale factor will be indicated in the scale factor edit field.

Calculate using Points:

Select two pairs of points (**old** and **new**) from which the scale factor shall be calculated. From the drop-down lists you may select any point which is either stored in local grid or can be converted to local grid in the project.

For both of the selected pairs of points (**old** and **new**) the distances between **Point Id 1** and **Point Id 2** will be calculated. The scale factor is derived by dividing the **new** by the **old** distance.

The calculated scale factor will be indicated in the scale factor edit field. The scale factor will be applied to the selection of points listed in the **Start** page.

Click **Next** to proceed with the [Shift/ Rotate/ Scale Wizard - Transformation parameters](#) page.

Tip:

- If you want to transform the distance between a pair of given points to a specified new distance, proceed as follows:

Select **Calculate using Points** and select the **Point Ids** between which the **old** distance shall be calculated from the corresponding drop down lists.

After that de-select **Calculate using Points**. **Calculate using Distances** becomes active. Enter the **new** distance manually.

The scale factor will then be computed from the **computed old** and the **manually entered new** distances.

Shift/ Rotate/ Scale: Transformation parameters

In this page you may select which transformation parameters shall be calculated when points are matched in the [Common Points](#) page.

Number of parameters:

Select **all** to compute all parameters for a Classical 2D Helmert transformation.

Select one of the predefined number of parameters (**2 shifts** or **2 shifts, rotation**). For the parameters that are set to **No**, a **Value** (which will be held fixed throughout the computation) can be introduced. Double-click on the parameter in the column **Value**, change the value and press Enter.

Shift/ Rotate/ Scale Wizard - Common Points

In this page you may determine the parameters for a Classical 2D Helmert transformation and a shift in height by matching common points.

The view is divided into 3 separate report views:

- The top left view lists all point triplets as given in the **Start** page plus all *Averaged* triplets stored as local grid.
- The top right view offers local grid points for matching. These points may be taken from any available project.
- The bottom view shows the matched coordinate pairs.

To match common points:

1. Click on a point in the top left view (System A).
2. From the drop-down list select the project from which you want to select a common point. All point triplets that are either **stored** in *local grid* or can be **converted** to *local grid* are listed in the top right report view (System B). Double-click onto any of the points to **match** Point A and B. Both points will be listed as **Point A** and **Point B** in the bottom report view.
3. Repeat steps 1. and 2. until all points (at least 2 points) are matched. The transformation is **re-calculated** with each additionally selected and matched common point. The bottom view indicates the **residuals** of the transformation in the columns **dE**, **dN**, **dH**.

Note: To remove a pair of matched points right-click onto the pair of points and select **Delete** from the context menu.

Once sufficient points are matched click **Next** to proceed with the **Shift/ Rotate/ Scale Wizard - Transformation parameters** page.

Note:

- You can select common points from different projects by selecting another project from the drop-down list after a point has been matched.
- If you want to manually enter coordinates for the common points:
 - Select **None** from the Project drop-down list.
 - Right-click into the top right report view (System B) and select **New Point...** from the background menu.
 - Modify the **Point Id** and **Coordinates** of the newly created common point via in-line editing or by selecting **Modify...** from the context menu.

Shift/ Rotate/ Scale Wizard - Transformation parameters

This page gives you an overview on the manually entered or calculated transformation parameters.

- **dE, dN, dH**: Shift parameters in Easting, Northing and Height.
- **Rz, Easting, Northing**: Rotation angle and coordinates of the rotation origin.
- **Scale factor**

To save the 2D transformation enter a **Name** and press **Save**.

The Classical 2D transformation will be added to the list of transformations in the [Coordinate System Management](#).

Note: The height shift will not be stored.

Click **Next** to [finish](#) the transformation.

Shift/ Rotate/ Scale Wizard - Finish Transformation

This page lists all triplets of all points that will be transformed using the parameters as indicated in the [Transformation parameters](#) page.

- Click **Finish** to update all points in the database. The existing local grid coordinates will be replaced with the coordinates as displayed in this page.
- Click **Back** if you want to modify the transformation parameters.
- Click **Cancel** to abort the operation without any changes to your project coordinates.

Note:

- As all raw observations remain unchanged, the orientation of all TPS setups included in the selection will be updated after finishing the Shift/ Rotate/ Scale wizard.

Exchange Coordinate System (Smart Station)

This command enables you to recalculate the station coordinates of a TPS setup or the coordinates of a set of points if the coordinate system used to derive the coordinates changes.

To exchange a coordinate system becomes necessary if your setup coordinates have been derived using a Smart Station instrument and only a preliminary coordinate system was available in the field.

To invoke the functionality:

- For a single TPS setup invoke the functionality from the **Setup Properties: General** page by pressing the  button in the lower left corner of the dialog.
- To exchange the coordinate system for one or for more than one setup select the setup(s) in the **TPS-Proc** report view and select **Exchange Coordinate System...** from the context menu or from the TPS-Proc main menu.
- You can also select a series of points in the **View/ Edit** or in the **Points** tabbed view and select **Exchange Coordinate system...** from the background context menu or from the main menu.

The **Exchange Coordinate System Wizard** starts.

Start:

In the **Start** page of the wizard you are presented with a list of all point triplets which will be recomputed. The points are given together with their local grid coordinates in a configurable report view.

- If you have selected a TPS setup in the **TPS-Proc** view, then the Reference triplet of the station setup and all connected measured point triplets will automatically be included in the list.
- If you have selected a series of points in **View/ Edit** or in the **Points** view, then the list of points is based upon the selection. It is influenced, though, by some conditions which add or remove points to or from the list as follows:
 - Only points stored with **Local Grid** coordinates are displayed. Point triplets which are **not** stored as Local Grid (but e.g. as WGS84) cannot and will not be transformed.
 - The points must have position information. **Height-only** point triplets will be **ignored**.
 - Only Point classes **Estimated, Measured, Reference, Adjusted** and **Control** will be listed.
 - Measured point triplets, **to which** an **observation** has been made, will be **removed** from the list, **if** the reference point (the TPS setup point) from which the observation has been made is **not included** in the selection **either**.
 - If you have selected a **Reference** point triplet, then **all** connected measured point triplets will automatically be included in the list.

By this selection mechanism it is ensured that setup and target points are always **transformed together**. Inconsistencies are avoided.

Coordinate System selection:

In the **Coordinate System selection** page of the wizard:

- Determine the **old** and the **new** coordinate system. All coordinate systems stored in the **Coordinate System Management** (except WGS1984 and None) are offered for selection.

- Decide if you want to **Keep the heights** of the preliminary system and transform only the position to the new coordinate system.
- Decide if you wish to **Attach the new coordinate system to the project**. This is recommended to ensure that any GPS measured points fit to the newly transformed TPS points.

Finish:

In the **Finish** page of the wizard the new local grid coordinates are listed for all point triplets. They are derived by transforming the original grid coordinates to **WGS84** using the **old coordinate system** and re-transforming the coordinates back to local grid using the **new coordinate system**.



- Click **Finish** to update all points in the database. The existing local grid coordinates will be replaced with the coordinates as displayed in this page.
- Click **Back** if you want to modify the coordinate systems.
- Click **Cancel** to abort the operation without any changes to your project coordinates.

Note:

- Since the backsight coordinates change together with the station coordinates for all setups of method **Set Orientation** or **Known Backsight** the orientation of the setup is updated after executing the **Exchange Coordinate System** command.



Rename Tool

The Rename Tool offers you the chance to rename a selection of points or lines/ areas.

- In  **View/ Edit** or in the  **Points View** select the points to be renamed and open the  **Rename Tool ...** from the **View/ Edit** or the **Points** main menu

Alternatively: Open the **Rename Tool ...** from the **View/ Edit** background menu or the **Points** context menu.

- In the **Lines/ Areas View** select the lines/ areas to be renamed and open the **Rename Tool ...** from the context menu.

The selected points or lines/ areas are listed in the Rename Tool with their **Current ID** and their **New ID**. If you see that by chance a point or line/ area is included that shall not be renamed it may be deleted from the selection by pressing the  **Delete item** button. You may also change the order of the points in the list by selecting a point and pressing the  **Move up/ down** buttons.

General:

Insert new ID:

Insert a new Id for the selected points. The new Id can be composed of new alphanumeric characters plus the **current Id** or **parts of the current Id**. Additionally, a **numeric counter** may be inserted. Spaces, dashes, dots and underscores may serve as separators.

Add/ insert current ID:

Press the button to insert the Id which the point(s) or line(s)/ area(s) currently have into the **Insert new ID** field. Before or after you may enter any combination of alphanumeric characters or add a counter to modify the current ID as desired.

Add/insert part of current ID:

Press the button to select and insert a part of the Id which the point(s) or line(s)/ area(s) currently have into the **Insert new ID** field. Before or after you may enter any combination of alphanumeric characters or add a counter to modify the partly used current ID as desired.

Add/ insert numeric counter:

Press the button to insert a numeric counter for renumbering the IDs. The following selection fields become active to define the counter:

Start counter at:

Define the number to start counting with.

Increment counter by:

Define how the counter shall be incremented.

Counter digits:

Define the digits that shall be reserved for inserting the counter.

A preview of the newly defined ID is given in the list below.

When you have finished redefining the IDs for the selected points, lines/ areas press **OK** to confirm the renaming and close the tool.

Press **Apply** to confirm the renaming and take over the **New IDs** as **Current IDs** as the basis for the next change without closing the tool. New IDs that are confirmed with **Apply** are remembered and offered in the **Insert new ID** drop down list for future selection.

Search and Replace:

Search for:

You may search for parts of the **current** Point or Line/ Area Ids that shall be renamed and replace these parts with a new combination of alphanumeric characters. You may also search for Spaces, dashes, dots and underscores to be replaced.

Note: Ids that have previously been confirmed by **Apply** are identified as the current Ids.

Replace with:



Define a replacement for the **Search** string. Spaces, dashes, dots and underscores may also serve or be included as part of the **Replace** string. If you want to remove a fixed part of the current IDs leave the replace string **empty**.

Again a preview of the **new** Point Ids is given in the list below.

When you have finished searching for and replacing IDs for the selected points, lines/ areas press **OK** to confirm the renaming and close the tool.

Press **Apply** to take over the **New IDs** as **Current IDs**. Search and Replace strings that have been confirmed with **Apply** are offered in the drop-down lists to be selected for future Search and Replace runs.

Move / Copy Points

1. In the **Points** Report-View of a Project select the points you want to copy or move.
2. Choose  **Copy** from the **Edit** menu or Toolbar.
3. Scroll to the **Points** Report-View of another Project.
4. Choose  **Paste** from the **Edit** menu or Toolbar.

Alternatively:

- Use **Drag and Drop** to move points from one location to another.

Tip:

- You can duplicate a point if you copy and paste it into the original Project. A new point with the point id extension (2) will be created.

Note:

- A selection of points may also be **sent to** the **Hard disk** or to a **Local memory device** via the **Send To** functionality in order to create a job that can be used with a SmartWorx or System 500 instrument.

Notes about Drag and Drop (Copy & Paste) Points

[Drag and Drop](#) (or Copy & Paste) Points between Projects has certain restrictions, especially if points are copied that already exist in another Project.

Copy to a Project (more than one coordinate triplet may exist for a point):

- Only the currently active coordinate triplet may be copied.
- If a coordinate triplet already exists in the target Project, a new point is created with a unique Point Id (E.g. 'PointA' is copied as 'PointA (2)') except for coordinate triplets of **Coordinate Class Measured**. Coordinate triplets of class *Measured* are added to an existing point and a new average is calculated.
- If the Point Id does not exist in the target project, a new point with the same Point Id is created. If a point with **Coordinate Class Average** or *Reference* is copied, the class is converted to *Control*.
- Raw data is not transferred when dragging and dropping (or Copy & Paste) points.

Related topics:

[Points View](#)

[Notes about importing Points](#)

Modifying Reference Coordinates

Reference triplets are created in the project database automatically when storing GPS-processing results, importing GPS Real-Time or TPS raw data, when importing GPS baseline vector information from ASCII files or when dragging and dropping observations (GPS or TPS) into the project.

For points that have been used as a GPS reference the reference coordinate triplet will be stored with its *WGS84* coordinates. For points that are associated with a TPS setup (containing TPS observations) the reference coordinate triplet will typically be stored with *Local Grid* coordinates.

If it turns out that wrong coordinates have been used for the reference in GPS-processing or for a TPS setup, then you have the chance to modify the reference coordinates later. This might be essential if you are, for example, a pure GPS Real-Time user who does not collect raw data and is, therefore, unable to post-process.

Modifying Reference Coordinates after Import:

In contrast to the Measured GPS Rover or TPS Target coordinates Reference coordinates can be viewed **and edited** in the [Point Properties – General](#) page. On selecting **OK** or **Apply** after making your modification, the difference in the Reference coordinates is computed. All rover/ target coordinates computed with respect to the modified reference will be shifted by the same amount.

If GPS **and** TPS observations are connected to the selected reference, then typically some Measured triplets will be stored in WGS84 (for GPS) and some in Local Grid (for TPS). Then a coordinate system is needed to apply the shift of the Reference coordinates to **all** connected Measured rover and target coordinates.

Note:

- If you attempt to change a GPS reference by more than 10m it will be recommended that you re-process the data. In order to do so raw data must be available. In re-processing the data the possibility of introducing scaling errors can be avoided.
- Incorrect GPS reference coordinates may arise due to incorrectly entered antenna heights or a wrongly assigned antenna. In this case you have the chance to modify the antenna heights directly under [Interval Properties \(Track\): Antenna](#).
- When modifying Reference coordinates the GPS baseline vectors (DX, DY, DZ) and all TPS observations remain unchanged. After the modification has been applied the affected Average coordinates will be re-computed. However, to avoid that a network of baselines becomes in-homogenous, modifying one Reference triplet never automatically shifts the coordinates of another Reference triplet.

Surfaces

Surfaces

The **Surfaces** view enables you to graphically view and edit all surfaces within a project. Surfaces may either be imported from SmartWorx jobs or they may be created manually in the **Surfaces** view. Surfaces can be visualized in a 2D or in a 3D view. Volumes can be calculated against reference heights or between surfaces.

- The Surfaces View may be accessed via the  **Surfaces** Tab from within a project window.

The view consists of three left-hand panes and two right-hand panes.

Example:

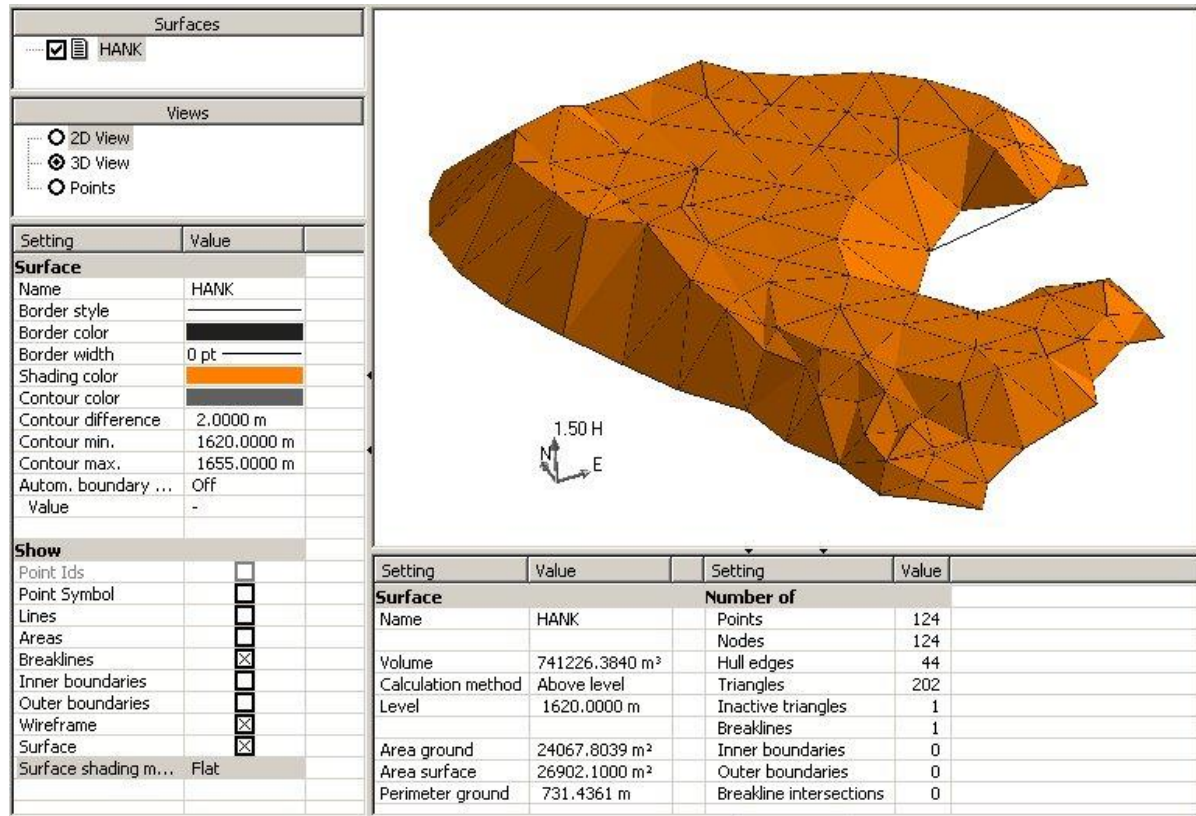

Setting	Value	Setting	Value
Surface		Number of	
Name	HANK	Points	124
Border style		Nodes	124
Border color		Hull edges	44
Border width	0 pt	Triangles	202
Shading color		Inactive triangles	1
Contour color		Breaklines	1
Contour difference	2.0000 m	Inner boundaries	0
Contour min.	1620.0000 m	Outer boundaries	0
Contour max.	1655.0000 m	Breakline intersections	0
Autom. boundary ...	Off		
Value	-		

In the top left-hand pane all surfaces currently stored in the project will be displayed.

- To create a new surface right-click into the **Surfaces** pane and select **New...** from the context menu. A default name will be given and can be edited.
- To later modify a surface name right-click onto the surface and select **Modify** from the context-menu.
- To delete a surface select **Delete** from the context menu. All points, lines and areas assigned to the surface will remain stored in the project.

One or more  **Surfaces** may be **activated** in the **Surfaces** pane. Depending on which view is currently active in the **Views** pane the right-hand pane either displays the **active** surface(s) graphically (**2D View**, **3D View**) or lists the points belonging to the **active** surface(s) in a report view (**Points** view).

To switch between the representations of the active surface(s) make your selection in the **Views** pane on the left-hand side of the window. You can choose between the following views:

- 2D View
- 3D View
- Points View

The lower part of the right-hand side displays the **Surface Property view** and represents the **Surface Results**. The calculated volume, the area and some more information is displayed for the **selected** surface.

To get an overview on the surface results in a printable report, including the information displayed in the **Surface Property view**, invoke the **Surface Report**.

The settings for the **selected** surface may be viewed and edited in the **Active Surface Settings** pane in the lower part of the left-hand side. The Active Surface Settings pane consists of two sections:

The **Surface** settings allow to select graphical settings for the selected surface and are independent of the selected view type (2D or 3D or Points). If more than one surface is stored in the project **select** the surface in the top part of the left-hand pane to individually change the following surface settings:

Name:

Indicates the name of the selected surface.

Border style/ color/ width:

Indicates the line style, color and width of the border of the triangles in the selected surface. The settings may be changed if necessary.

Shading color:

Indicates the shading color of the selected surface. The color may be changed if necessary.

Contour settings:

In the **2D View** you can select to display contour lines. For the contour lines you can select the **color**, the **difference** between contour lines and set a **minimum** and **maximum** height value for the contour lines. The color of the contour lines can be set separately for all contour lines which lie above or below a given **threshold** height.

Autom. boundary creation:

To avoid flat triangles being built at the edge of the surface model the settings for **Automatic boundary creation** may be modified. Choose between **Distance** or **Angle** and enter a **Value** for one or the other. Automatic boundary creation may also be switched **Off**. Selecting a Distance criteria will avoid triangles with sides longer than the specified distance being built at the edge of the surface. Selecting an Angle criteria will avoid triangles with angles smaller than the specified value being built at the edge of the surface.

The additional settings that can be selected in the **Show** section allow to switch the most important **Graphical Settings** on and off. These settings are dependent on whether the 2D or the 3D view is selected for display. For a description of the view dependent settings refer to the topics **2D View** and **3D View**.

See also:

- Surfaces: 2D View
- Surfaces: 3D View

Surfaces: Points View

Graphical Settings (Surfaces)

Surface Results

Surface Report

Assign/ Remove points to/from a surface

Include/ Exclude triangles

Breaklines

Boundaries

Exporting Surfaces

Assign/ Remove points to/from a surface

Points stored in the project can be assigned to a surface or can be removed from a surface. When assigning or removing points the surface and its configured volume is instantly re-calculated.

To assign points to an existing surface:

Points in the project which are not belonging to a surface may be **assigned** to a surface if necessary.

- In the **Surfaces** view make sure **Unassigned Points** are **enabled** to be displayed for the **2D view**. In the 2D View select one or more points and select **Assign to**. If more than one surface is activated within the project select the surface to which the point(s) shall be assigned.

Alternatively points can also be assigned to an existing surface from within the **View/Edit** or **Points** tabbed view. Highlight the points and select **Assign to surface** from the context-menu.

To remove points from a surface:

Points belonging to the **active** surface(s) may be **removed** in the **2D View** or in the **Points** view.

- Select the point(s) to be removed. Then select **Remove (Point)** from the context/ background menu.

Removed points are removed from the surface but remain stored in the project. They may be **assigned** to the surface again if necessary. They will not show up in the Points view any longer.

Note:

- The current triplet of the points will be used for the triangulation. It must either be stored with *Local Grid* coordinates or the coordinate system attached to the project must allow to convert the point to *Local Grid* coordinates. Only points with *Position and Height* information can be included in surface calculations.
- **Unassigned Points** can be switched on or off for display in the Settings view on the left-hand pane of the window. The color of Unassigned Points can be selected in the **Graphical Settings: Color** dialog.

Activate/ De-activate points

Points belonging to the **active** surface(s) may be **activated** or **de-activated** in the **2D View** or in the **Points** view.

- Select the point(s) to be activated/ de-activated. Then select **Activate/ De-activate (Point)** from the context/ background menu.

De-activated points are excluded from the surface, but remain assigned to the surface. For the remaining active points the triangulation will be re-computed. De-activated points may be activated again.

See also:

[Assign/ remove points to/ from a surface](#)

[Include/ Exclude triangles](#)

Include/ Exclude triangles

Triangles belonging to the **active** surface(s) may be **excluded** from the surface as well as **included** again in the **2D View**.

- To include or exclude a single triangle select the triangle and select **Include** or **Exclude** from the background context menu.
- If you multi-select triangles by dragging a rectangle around the desired area, only those triangles will be included into the selection, of which all three points constituting the triangle are included into the selection. To include or exclude the selected triangles select **Include triangles** or **Exclude triangles** from the background context-menu.

Note: If you have zoomed into the view you must select **Include triangles** or **Exclude triangles** from the Surfaces main menu.

When including or excluding triangles the surface and its configured volume is instantly re-calculated.

Breaklines

Breaklines are lines with a constant grade, which can be introduced into the surface calculation. For example, the side of a road or the top of a ridge can be defined as a breakline. Assigning breaklines to a surface will force the triangles in the terrain model to be rebuilt by taking the grade of the line into account. As a consequence the breaklines will become triangle edges and there will not be any incorrect interpolation across the breaklines.

Breaklines can be defined as lines connecting any point stored in the project. The points from which the breakline is built do not have to be assigned to the surface. You can either assign a line already stored in the project to a surface or you can manually create new breaklines in the **Surfaces** view.

To assign an existing line as a breakline:

- In the **Surfaces** view make sure **Lines** are **enabled** to be displayed for the **2D view**. In the 2D View right-click on the line and select **Assign Breakline to**. If more than one surface is activated within the project select the surface to which the breakline shall be assigned.

To create a new breakline for the selected surface:

- Within the Surfaces tabbed view select **New** and **Breakline** from the background context-menu of the **2D View**. Select one after the other the points that shall belong to the breakline. When the breakline that shall be created is complete, right click and select **Enter** from the context menu. To change the graphical representation of the line select **Enter & Edit** from the context menu. To abort the creation of the breakline select **Cancel** from the context menu.

Note: Breaklines created in the Surfaces tabbed view are also visible as lines in the **View/Edit** tabbed view.

Effect of introducing breaklines:

When a new breakline is assigned to a surface, the intersections between the breakline and all existing triangle edges are calculated. For the resulting new break points the heights will be interpolated along the breakline. The new break points are added to the model and new triangles will be built automatically.

[Example:](#)

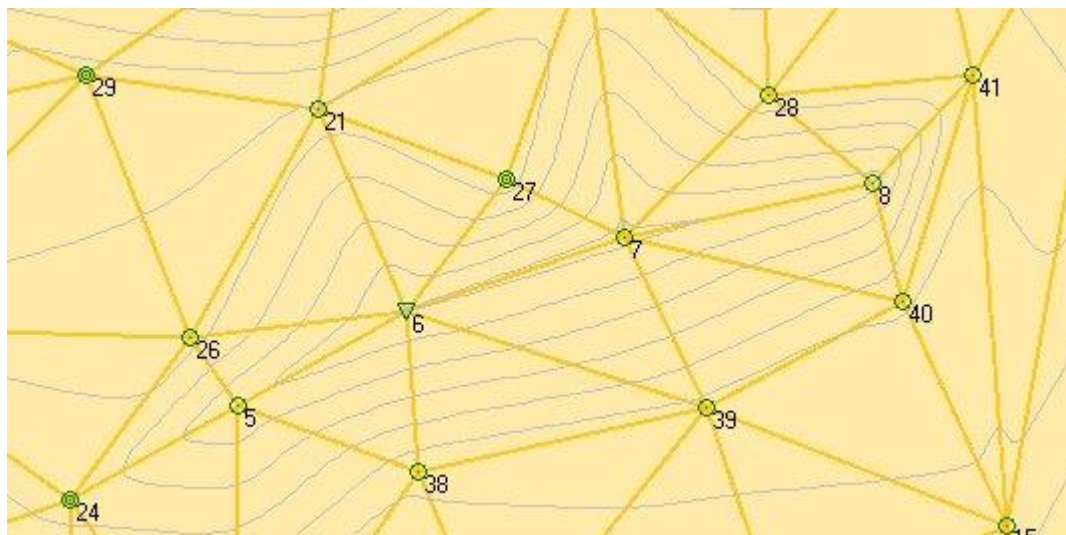

After introducing the red line as a **breakline** additional triangles will be built as shown below:

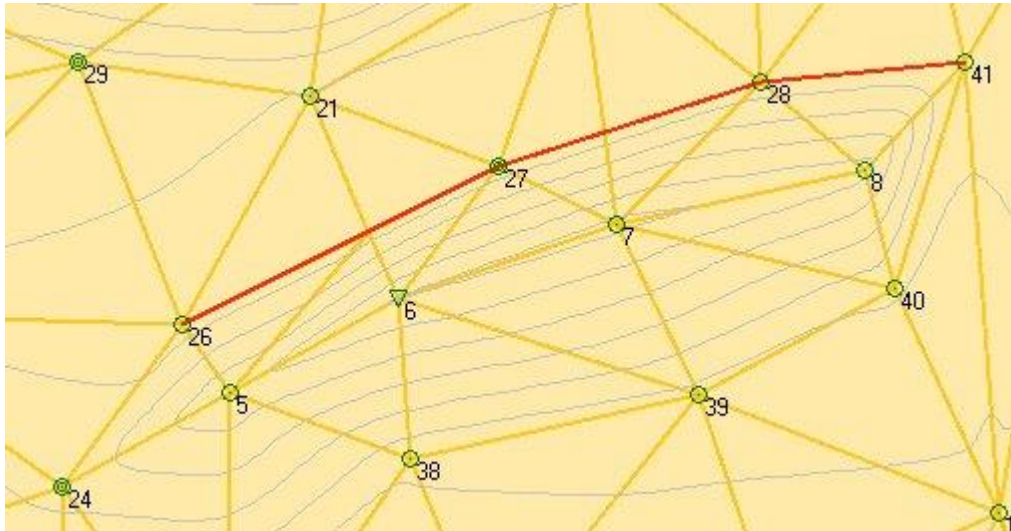

If the start or end point of a breakline lies within an active triangle, these points will be added to the triangulation. Parts of a breakline outside the boundary will be ignored.

To remove a breakline from a surface:

- In the **Surfaces 2D** view right-click on the breakline and select **Remove breakline from** from the context menu. If a breakline is simultaneously assigned to more than one surface select the surface from which the breakline shall be removed.

Graphical Settings:

Breaklines can be switched on or off for display in the Settings view on the left-hand pane of the window. The color of breaklines can be selected in the [Graphical Settings: Color](#) dialog.

Note:

- Breaklines must not cross each other unless they pass through a common point. Crossing breaklines are reported in the Surface property view below the displayed surface.

Boundaries

Two types of boundaries are supported within the **Surfaces** view:

- **Include boundaries** are areas that should be included in the terrain model. Points outside an Include boundary are discarded for the surface model calculation.
- **Exclude boundaries** are areas inside an Include boundary that shall be excluded from the calculation.

Automatic boundary calculation:

When the surface is created an **Include boundary** is automatically built as the convex hull of all surface points. The definition of this automatically created boundary can be modified with some settings available from the **Active Surface Settings** pane. This may help to avoid flat triangles being built at the edge of the model:

- In the **Active Surface Settings** pane you can choose three different methods for **Autom. Boundary creation**:
 - Off**: the automatically created Include boundary (the convex hull of all surface points) is taken.
 - Distance**: Outer triangles of which one edge is longer than the user-defined **Value** will be excluded from the surface.
 - Angle**: Outer triangles in which one angle is smaller than the user-defined **Value** will be excluded from the surface.

Manual boundary calculation:

Manually adding boundary lines will force the triangles in the terrain model to be rebuilt. Boundary lines will become triangle edges and intersections between boundary lines and existing triangle edges will be introduced into the computation as additional break points.

Boundaries can be defined as areas connecting any point stored in the project. The points from which the boundary is created do not have to be assigned to the surface. You can either assign an area already stored in the project to a surface or you can manually create new boundaries in the **Surfaces** view.

To assign an existing area as a boundary:

- In the **Active Surface Settings** pane of the **Surfaces** view make sure **Areas** are **enabled** to be displayed for the **2D View**. In the **2D View** right-click on the area and select **Assign Include Boundary to** or **Assign Exclude Boundary to**. If more than one surface is activated within the project select the surface to which the boundary shall be assigned.

To create a new boundary for the selected surface:

- Within the **Surfaces** tabbed view select **New** and **Include Boundary** or **Exclude Boundary** from the background context-menu of the **2D View**. Select one after the other the points that shall belong to the boundary. When the boundary that shall be created is complete, right click and select **Enter** from the context menu. To change the graphical representation of the boundary select **Enter & Edit** from the context menu. To abort the creation of the boundary select **Cancel** from the context menu.

Note: Boundaries created in the **Surfaces** tabbed view are also visible as areas in the **View/Edit** tabbed view.

Effect of introducing boundary lines:

When a new boundary is assigned to a surface, the intersections between the boundary and all existing triangle edges are calculated. For the resulting new break points the heights will be interpolated along the triangle edges. The new break points are added to the model and new triangles will be built automatically.

[Example:](#)

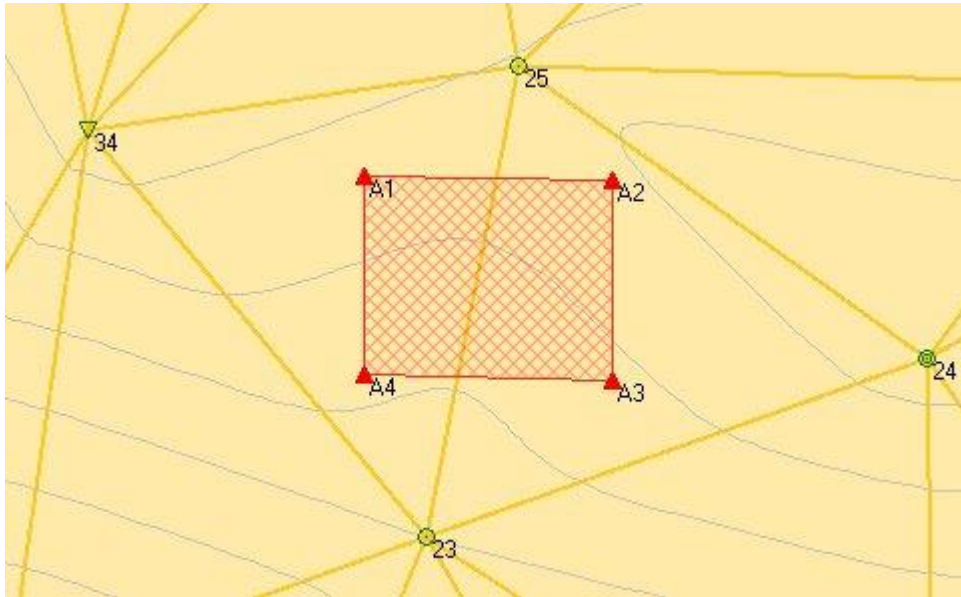

After introducing the red area (A1-A2-A3-A4) as an **exclude boundary** additional triangles will be built as shown below:

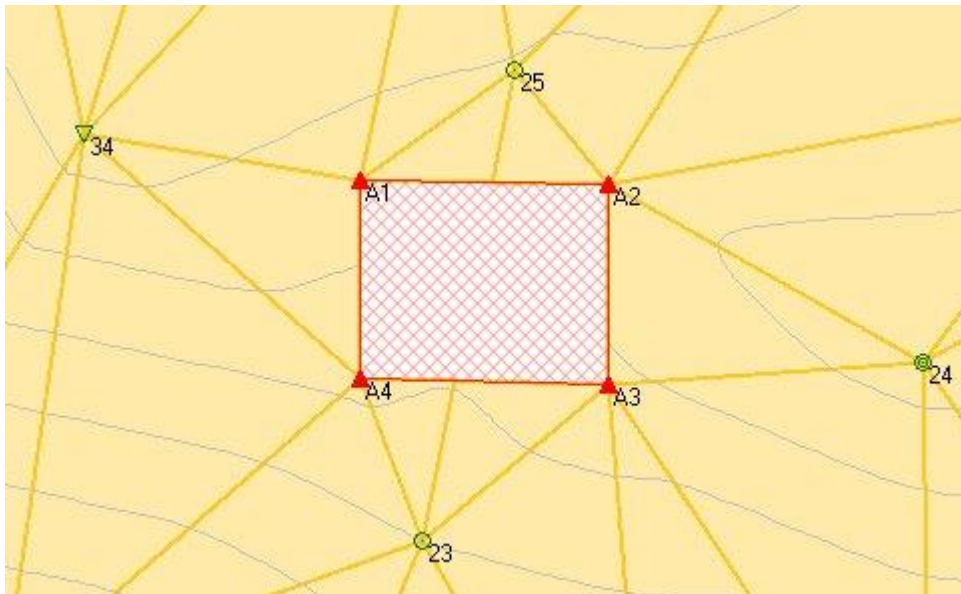

Boundary points that fall within existing triangles will be added to the surface. The height will be interpolated within the triangle plane.

To remove a boundary from a surface:

- In the **Surfaces 2D** graphical view right-click on the boundary and select **Remove Include Boundary from** or **Remove Exclude Boundary from** from the context menu. If a boundary is simultaneously assigned to more than one surface select the surface from which the boundary shall be removed.

Graphical Settings:

Include Boundaries and **Exclude Boundaries** can separately be switched on or off for display in the Settings view on the left-hand pane of the window. The color of Include Boundaries and Exclude Boundaries can be selected in the [Graphical Settings: Color](#) dialog.

Surfaces: 2D View

In the 2D View all **active** surfaces are graphically displayed with their triangle representation in the right-hand pane.

Surface Settings:

Independent of whether a surface is active or not it may be **selected** in the **Surfaces** pane. The **Settings** for the currently selected surface may be viewed and edited in the **Active Surface Settings** pane on the left-hand side:

Name:

Indicates the name of the selected surface.

Border style/ color/ width:

Indicates the line style, color and width of the border of the triangles in the selected surface. The settings may be changed if necessary.

Shading color:

Indicates the shading color of the selected surface. The color may be changed if necessary.

Contour settings:

For the contour lines you can select the **color**, the **difference** between contour lines and set a **minimum** and **maximum** height value for the contour lines.

Autom. boundary creation:

To avoid flat triangles being built at the edge of the surface model the settings for **Automatic boundary creation** may be modified. Choose between **Distance** or **Angle** and enter a **Value** for one or the other. Automatic boundary creation may also be switched **Off**. Selecting a Distance criteria will avoid triangles with sides longer than the specified distance being built at the edge of the surface. Selecting an Angle criteria will avoid triangles with angles smaller than the specified value being built at the edge of the surface.

Show Graphical Settings:

The additional settings that can be selected in the **Show** section allow to switch the most important **Graphical Settings** on or off.

Point Ids and **Height values** for the points belonging to the active surfaces may be switched on or off.

Lines and **Areas** contained in the project may be switched on or off. Both have to be **enabled** to assign an existing line as a **Breakline** or an existing area as a **Boundary** to a surface. Lines and Areas will be displayed with the color, style and width for line, border and shading as defined in the **Line/ Area Properties**.

Unassigned Points may be switched on and off. This will display all points stored in the project, which are not yet assigned to the active surfaces. Unassigned points have to be **enabled** to assign them to a surface. The color of Unassigned Points can be selected in the **Graphical Settings: Color** dialog.



Breaklines, **Exclude** and **Include Boundaries** assigned to the active surface(s) can be switched on or off for display. No matter whether breaklines or boundaries are switched on or off, they will always be used for the calculation of the surface. The color of breaklines, exclude and include boundaries can separately be selected in the **Graphical Settings: Color** dialog.

Contour lines can be switched on or off for display. The color, the difference between contour lines and a minimum and maximum height value for the contour lines can be defined in the Active Surface Settings pane. The color of the contour lines can be set separately for all contour lines which lie above or below a given threshold height.

When Contours are **enabled** you can additionally set the **Contour mode** to either **Straight** or **Spline**. When selecting **Straight**, the contour lines will be drawn as straight lines from one triangle side to the next.

The Surfaces 2D View offers the following functionality:

- You can **activate/ de-activate points**. De-activated points will be excluded from the triangulation.

- You can **assign new points** to the surface. Unassigned points need to be switched on for display. Points can also be removed from the surface.
- You can invoke the **Point Properties** or the **Line/ Area Properties** for existing points, lines and areas.
- You can **include/ exclude triangles**. Excluded triangles will not be used for the surface calculations.
- You can create new **breaklines** or assign an existing **line** as a breakline to the surface. Breaklines can also be removed from the surface. For details see: **Breaklines**.
- You can create new **include** or **exclude boundaries** or assign an existing **area** as a boundary to the surface. Boundaries can also be removed from the surface. For details see: **Boundaries**.
- With a double-click into the view you can create a new point. If you click inside a triangle of an existing surface, the height of the new point will be interpolated within the triangle. If you click outside of the surface a height of zero will be assumed.
- To zoom in or out of the view right click and select **Zoom In**, **Zoom Out** or **Zoom 100%** from the view's background menu. Alternatively, use the corresponding toolbar buttons (, ) from the **View** toolbar.
- By default, **Panning** is switched on so that you can comfortably navigate within the view.
- To modify the Graphical Settings right-click and select **Graphical Settings...** from the background menu. Via the Graphical Settings functionality you may even decide to activate a **background image** for the view. The background image has to be attached to the project first. You may do so in the **Background Image** page of the **Project Properties** dialog. Select **Blend image** from the background context-menu to achieve a better contrast of the surface elements to the background image.
- Select **Print** from the **File** menu or click on  from the toolbar to print the contents of the 2D view. A **Print Preview** is also available.

Surfaces: 3D View

In the 3D View all **active** surfaces are graphically displayed as a three-dimensional terrain model in the right-hand pane.

Surface Settings:

Independent of whether a surface is active or not it may be **selected** in the **Surfaces** pane. The **Settings** for the currently selected surface may be viewed and edited in the **Active Surface Settings** pane on the left-hand side:

Name:

Indicates the name of the selected surface.

Border style/ color/ width:

Indicates the line style, color and width of the border of the triangles in the selected surface. The settings may be changed if necessary.

Shading color:

Indicates the shading color of the selected surface. The color may be changed if necessary.

Contour settings:

For the contour lines you can select the **color**, the **difference** between contour lines and set a **minimum** and **maximum** height value for the contour lines. Contour lines can only be displayed in the **2D View**.

Autom. boundary creation:

To avoid flat triangles being built at the edge of the surface model the settings for **Automatic boundary creation** may be modified. Choose between **Distance** or **Angle** and enter a **Value** for one or the other. Automatic boundary creation may also be switched **Off**. Selecting a Distance criteria will avoid triangles with sides longer than the specified distance being built at the edge of the surface. Selecting an Angle criteria will avoid triangles with angles smaller than the specified value being built at the edge of the surface.

Show Graphical Settings:

The additional settings that can be selected in the **Show** section allow to switch the most important **Graphical Settings** on or off.

Point Ids and **Point Symbols** for the points belonging to the active surfaces may be switched on or off. Point Symbols can only be selected, if Point Ids are also selected.



Lines and **Areas** contained in the project may be switched on or off. Area shading is not applied for the Surfaces 3D view.

Breaklines, **Exclude** and **Include Boundaries** assigned to the active surface(s) can be switched on or off for display. No matter whether breaklines or boundaries are switched on or off, they will always be used for the calculation of the surface. The color of breaklines, exclude and include boundaries can separately be selected in the **Graphical Settings: Color** dialog.

Wireframe/ Surface: The surface can either be displayed with its **wireframe** or with the **surface** triangles or with the combination of both. When Surface is **enabled** you can additionally set the **Surface shading mode** to be either **Flat** or **Smooth**.

The Surfaces 3D View offers the following functionality:

Using the keyboard or the mouse the following operations are supported in the Surfaces 3D View:

- To **zoom in or out** of the view press the **+** or **-** buttons on the keyboard or use the mouse wheel. Alternatively, use the corresponding toolbar buttons (, ) from the **View** toolbar.
- To **pan** the view press Shift (or Ctrl) while moving with the mouse.

- To **rotate** the view move the mouse while holding the left mouse button pressed. To rotate around the axes you can alternatively use the arrow keys from the keyboard.
- Press **T** to decrease the transparency of the surface. **Shift-T** or **Ctrl-T** increases the transparency again.
- Press **A** to increase the brightness of the light shining onto the surface. **Shift-A** or **Ctrl-A** decreases the brightness again.
- Press **D** (or **Shift-D** / **Ctrl-D**) to change how diffuse the light shall be.
- Press **E** to change the vertical exaggeration of the model. The exaggeration value is printed next to the height axes in the symbol representing the direction of the Easting, Northing and Height axes. **Shift-E** or **Ctrl-E** reduces the vertical exaggeration again.
- Press **Home** (or **End**) to reset the 3D view back to the defaults (view from above).

Select **Print** from the **File** menu or click on  from the toolbar to print the contents of the 3D view. A **Print Preview** is also available.

Surfaces: Points View

In the **Points** view all points belonging to all **active** surfaces are listed in a report view in the right-hand pane. As in the **2D graphical view** the **Settings** of the currently **selected** surface may be viewed and edited in the **Active Surface Settings** pane on the left-hand side.

The following functionality is available in the **Points** view:

- You can **activate/ de-activate points**. De-activated points will be excluded from the triangulation.
- You can **assign points** to surfaces, to which the points are not yet assigned. You can also remove points from the surface.
- Right-click and select Properties... to change the **Point Properties** of the selected point.

See also:

[Surfaces: 2D View](#)

[Surfaces: 3D View](#)

Graphical Settings

Graphical Settings (Surfaces)

The **Graphical settings** dialog enables you to configure the graphical view. You may configure which items to display, select the colors of graphical elements and the font for text items.

1. From the context menu (right-click) or the **View** main menu select **Graphical Settings....**
2. In the **Graphical settings** dialog use the tabs to switch between the following pages:

View
Grid
Color
Font

3. Make your changes or press the **Default** button to reset the parameters to their default values.
4. Press **OK** to confirm or **Cancel** to abort the function.

Graphical Settings: View

This Property-Page enables you to define which graphical elements shall be displayed in the Surfaces view.

General:

Grid

Check to display a coordinate grid.

Note: To configure the grid see: [Grid](#)

North Arrow

Check to display an arrow in the upper right corner pointing to the north.

Scale Bar

Check to display a Scale Bar in the lower left corner of the screen. The Scale bar will alter its size and description to suit the scale at which you are zoomed in. Additionally, the scale bar will appear on any printout that you make, when activated.

Coordinate Tracking

Check to display the mouse coordinates in the Status Line.

Background Image

Check to display the referenced image which has been [attached](#) to the project as a background image.

Data:

Point Ids

Check to display the Point Identifications.

Note: To configure the font see: [Font](#).

Height Value

Check to display the Height Values

Note: Height values are only displayed if the font for **Point Id** is a  True Type font. To configure the font see: [Font](#).

Lines/ Areas

Check to display the Lines/ Areas contained in the project.

Unassigned Points

Check to display the points in the project which are not assigned to the selected surface(s).

Breaklines

Check to display the breaklines.

Exclude/ Include boundaries

Check to display the boundaries.

Graphical Settings: Color

This Property-Page enables you to set the color of the database items.

- In the **Color** column double-click onto the corresponding color field and select a color from the in-line edit combo box.

Background

Select a color from the in-line edit combo box to set the color of the view's background.

Unassigned Points

Select a color from the in-line edit combo box to set the color of the points not yet assigned to the surface.

Breaklines

Select a color from the in-line edit combo box to set the color of Breaklines.

Include Boundaries

Select a color from the in-line edit combo box to set the color of Include Boundaries.

Exclude Boundaries

Select a color from the in-line edit combo box to set the color of Exclude Boundaries.

Surface Results

Computed results such as volumes, areas and additional statistical information is presented in a property view underneath the **Surface** view. If more than one surface is **activated**, the information is displayed for the currently **selected** surface.

The following information is provided:

- **Surface name**
- Calculated **volume** (above reference height or against surface): Cut, Fill and Total Volume.
- **Areas** (ground and surface)
- **Perimeter**
- Number of elements defining the surface (points, edges, triangles, breaklines, boundaries,...)
- **Breakline intersections**: This value should be zero, since breaklines should not cross each other unless they pass through a common point.

To calculate volumes:

- Select the surface in the Surfaces pane in the upper part of the left-hand view.
- Select the **Calculation method** via inline-editing in the property view below the displayed surface. You can choose between a calculation **Above level** and **Against surface**.
- When calculating the volume above a level, specify the height of the reference plane via inline-edit in the **Level** edit field. When calculating the volume against another surface, specify the reference surface via inline-edit in the **Surface** edit field. At least two surfaces must be stored within the project to use this option. In both cases the calculated volume is instantly displayed.

Note:

- When one item of the surface results is selected in the **Surface Property view** select **Print** from the **File** menu or click on  from the toolbar to print the results for the selected surface. A **Print Preview** is also available.
- To get an overview on the surface results in a printable HTML report, including the information displayed in the **Surface Property view**, invoke the [Surface Report](#).

Surface Report

To get an overview on the **results** of a Surface calculation in your project you may invoke the **Surface Report**.

- In the  **Surfaces** view right-click on a surface in the **Surfaces** pane and select **Surface Report** from the context menu to invoke a report on the calculated results for the selected surface.

Alternatively: Select **Surface Report** from the **Surfaces** main menu to create a report for the surface that is currently **selected** in the **Surfaces** pane.

The report opens in a stand-alone window and is listed in the **Open Documents** list bar.

Stand-alone reports can be saved as HTML files or printed:

- To save a report as an HTML file right-click inside the report and select **Save As....**
- To print a report right-click inside the report and select **Print**. A **Print Preview** is also available from the context menu.
- To select the **contents** and the **format** of the report right-click and select **Properties...** from the context menu or click  in the **Reports** toolbar. For further details refer to: [Configure a Report](#).

When the report has been configured to display all possible sections it presents you with the following information:

- Project Information**
- Surface Results**
- Surface (Graphics)**

Project Information

[Example:](#)

Project Information

Project name:	Surface Data HANK
Date created:	19-10-06 13:31:51
Time zone:	1h 00'
Coordinate system name:	WGS 1984
Application software:	LEICA Geo Office 6.0

This section gives you general information on the **Project Properties**, like the project name, creation date and time and the attached coordinate system.

If information has been entered in the **Dictionary** page of the Project Properties dialog these pieces of information will be added to this section of the report.

Surface Results

[Example:](#)

Surface Results

Name:	HANK
Calculation method:	Above level
Level:	1600.0000 m
Volume:	1233646.1304 m ³
Cut (+):	1233646.1304 m ³
Fill (-):	0.0000 m ³
Area ground:	24281.6777 m ²
Area surface:	27133.3114 m ²
Perimeter ground:	731.4361 m

Numbers of:

Points:	126
Nodes:	125
Hull edges:	44
Triangles:	204
Inactive triangles:	0
Breaklines:	0
Outer boundaries:	1
Inner boundaries:	0
Breakline intersections:	0

This section lists the information displayed for the currently selected surface in the [Surface Results](#) pane when the report is invoked.

Surface (Graphics)

[Example:](#)

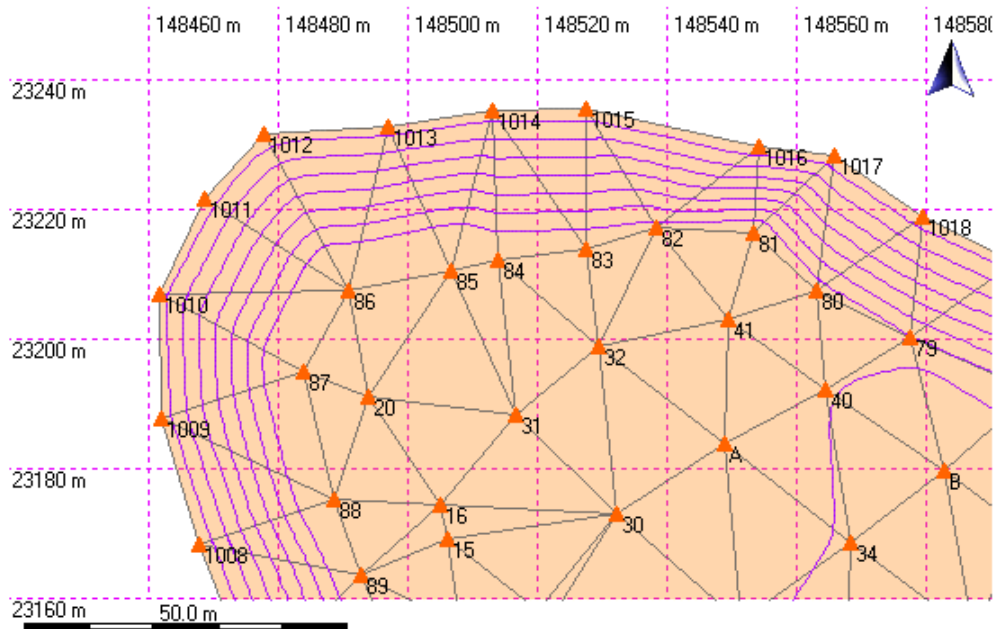
Surface (Graphics)

If the **2D** or the **3D View** is switched on in **Views** pane of the **Surfaces** view then the **Graphics** section integrates the currently active view as an image into the report. The Graphics show all surfaces which are currently **active** in the view. It is embedded according to the currently defined **Graphical Settings**.

Create a Difference Surface

This functionality allows you to generate a **Difference Surface** between two surfaces stored in the same project. The Difference Surface is a new surface for which the heights result from the differences between the two selected surfaces. The contour lines of the Difference Surface represent the cut and fill areas resulting from intersecting the two surfaces. The volume above zero elevation for the Difference Surface equals the volume between the two surfaces.

To create a Difference Surface:

- In the **Surfaces** pane of the  **Surfaces** view right-click and select **New Difference Surface...** from the context menu.

In the **New Difference Surface** dialog:

1. Decide on a **Name** for the new Difference Surface.
2. Select **Surface A** and **Surface B** from the combo boxes. Both will be subtracted from each other.
3. Click **OK** to create the new Difference Surface. It will be added to the list of surfaces in the **Surfaces** pane.

When changes have been made to one of the two surfaces, from which the Difference Surface is derived, you can recalculate the difference surface.

Note that both surfaces must still exist in the project to perform this operation.

To update a Difference Surface:

- In the **Surfaces** pane of the  **Surfaces** view right-click on the Difference Surface and select **Update Difference Surface** from the context menu.
The surface will be recalculated.

Note:

- **Breaklines** or **Boundaries** defined in one of the two surfaces from which the Difference Surface is created, will result in points being calculated for the new surface. The Breaklines or Boundaries themselves will not be included in the Difference Surface.
- The points defining the Difference Surface are calculated from intersecting two surfaces and are not stored into the project. The **Points** view of the Difference Surface remains empty.

Exporting Surfaces

Surfaces can either be exported to a SmartWorx **DTM job** or to a **DXF file**. SmartWorx DTM jobs can be used for staking out the digital terrain model defined by the surface using a TPS or GPS instrument. DXF files exported from a given surface include the triangles and / or the contour lines as calculated with the current settings.

To export a surface to a DTM job

1. Activate all surfaces that shall be exported to a DTM job and select **Export surfaces as DTM job...** from the context menu of the *Surfaces* section in the upper left pane of the view or from the *Surfaces* main menu. Each surface will be exported to a separate layer within the DTM job.
2. In the dialog **Export surfaces to DTM job** browse to the folder where the job shall be written and specify a file name. The job name will be taken from the project name.

To export a surface to a DXF file

1. Activate all surfaces that shall be exported to a DXF file and select **Export surfaces as DXF...** from the context menu of the *Surfaces* section in the upper left pane of the view or from the *Surfaces* main menu. Each surface will be exported to a separate layer within the DXF file.
2. In the dialog **Export surfaces to DXF** browse to the folder where the file shall be written and specify a file name. Additionally you can select the AutoCAD Release version in the *Save as type* combo-box. Press the **Settings** button to edit the **Export Settings**.
3. In the **Export Settings** dialog select whether you want to **Export triangles** and/ or **Export contours**.

For each setting you may define the **Line Color** and **Thickness**. For contour lines you may additionally define the **Contour mode** (i.e. whether the contour line shall be displayed as straight lines or as splines). If set to **Spline** the spline representation of the contour line is approximated by a polyline consisting of a series of straights.

If you select to **Apply individual surface settings** then the color and line thickness of the triangles as well as the color and mode of the contour lines will be exported as defined in the project.

Triangles and **Contour lines** will be exported to separate layers in the DXF file.

Note:

- Surfaces can also be exported to a LandXML file via the [Export LandXML file tool](#).

Antennas

Antennas View

The Antennas View of a Project lists all the Antenna Types that are used with this Project, i.e. the antenna types that are associated with the observation intervals of the raw data.

It is theoretically possible to create new Antenna Types in this view. These new antenna types can then only be used with this project but are lost upon deleting the project. Thus it is advised to create new antenna types using the global [Antenna Management](#) tool and then [Drag and Drop](#) this new antenna to the project and/or upload them on to the receiver.

- The Antennas View may be accessed via the  **Antennas** Tab from within a project window.

or

- via Project Management by clicking on **Antennas** in the Tree View.

Refer to [Antenna Management](#) on how to use the Report View of the Antennas View.

Note:

- If you download GPS raw data, the appropriate Antenna Type is also downloaded to the project. If for some reason you want to change the Antenna Type of your GPS raw data [Drag and Drop](#) the appropriate Antenna Type from the Antenna Management to the Antennas View of the Project and then set the new Antenna Type using the [Interval Properties](#) of the Data Processing View.
- The Leica antennas that are associated with raw data are marked  and cannot be deleted.

Antenna Management

A GPS baseline consists of the vector between the phase center of two GPS antennas. Each antenna type (brand, model) has its own phase center offset. This is especially noticeable if baselines are processed using mixed GPS antennas.

The phase center offset of different antennas varies especially in terms of a height difference between the L1 and L2 phase center. The difference in position usually is negligible.

The Antenna Management enables you to manage the phase center offsets for different GPS antennas. The offsets are then applied as corrections during the baseline processing.

The phase center offsets are defined relative to a [Reference Antenna](#). The reference antenna is a **Dorne-Margolin Type T** choke ring antenna.

All Leica antennas have been calibrated against the reference antenna and the relative offsets are already hardwired in the Office software. Thus if you are using Leica antennas only, the appropriate corrections are applied automatically and the user is not required to make any changes in the Antenna Management tool.

Normally, the antenna type is set on the receiver in the field. If you download GPS raw data, the appropriate antenna type is also downloaded to the project. If you want to assign a different antenna type to your GPS raw data [Drag and Drop](#) the appropriate antenna type from the Antenna Management to the [Antennas View](#) of the Project and then set the new antenna type using the [Interval Properties](#) of the Data Processing View.

To start the Antenna Management proceed as follows:

- From the Tools menu, select Antenna Management or click on  in the **Tools** List Bar.

Select from the list below to learn more about Antenna Management:

[Add a New Antenna](#)

[Modify](#)

[Delete an Antenna](#)

[Import Antenna file](#)

[Send To](#)

[Antenna Properties](#)

Related topics:

[Reference Antenna for phase center offsets](#)

[Antenna Height Reading](#)

[Antennas View of a Project](#)

Results

Results View (GPS)

The Results View is used to display the results of the [GPS-Processing](#). The Results View can be accessed using the **Results** tab of a Project window.

For each processing run a set of results will be created. A set of results comprises of a list of **Baselines**, a list of **Points** (rover only), a list of data-processing **Parameters** and a set of [GPS-processing Reports](#).

For each computed baseline (or SPP result) an [analysis tool](#) is available for advanced users to graphically display residuals, elevation, azimuth and DOP values.

After inspection of the data processing results you may select individual or all baselines and [store](#) them in the Project database.

By default each processing run will be named by the date and time the processing was initiated. This name can be modified. The number of processing runs that shall be retained can be set under [Results Configuration](#) (default is 3). If the number of processing runs exceeds the number set in the configuration, the oldest processing run will be deleted.

Select from below to learn more about GPS-Processing Results:

[Baseline Results](#)

[Point Results](#)

[GPS-Processing Parameters](#)

[GPS-processing Reports](#)

[GPS-Processing Analysis Tool](#)

[Modify the Name of a Processing Run](#)

[Delete a Processing Run](#)

[Keep a Processing Run](#)

[Results Configuration](#)

[Default Selection Criteria](#)

[View Configuration](#)

[Store the Results](#)

Results View (Level)

The Results View is used to display the results of the [Level Processing](#). The Results View can be accessed using the **Results** tab of a Project window.

For each processing run a set of results will be created. A set of results comprises of a list of **Points**, a list of level-processing **Parameters** and a **Summary Report**.

After inspection of the level processing results you may select individual or all points and [store](#) them in the Project database.

By default each processing run will be named by the date and time the processing was initiated. This name can be modified. The number of processing runs that shall be retained can be set under [Results Configuration](#) (default is 3). If the number of processing runs exceeds the number set in the configuration, the oldest processing run will be deleted.

Select from below to learn more about Level Processing Results:

[Point Results \(Level\)](#)

[Level-processing Parameters](#)

[Summary Report](#)

[Modify the Name of a Processing Run](#)

[Delete a Processing Run](#)

[Keep a Processing Run](#)

[Results Configuration](#)

[Store the Results](#)

Results Configuration

Number of retained computation runs:

Enables you to define the number of processing runs that shall be retained. If the number of processing runs exceeds the number set, the oldest processing run will be deleted automatically unless the **Keep Status** is set to Yes.

1. In the Tree-View right-click in the background or on  **Results** and select **Results Configuration**. Alternatively, right-click in the **Results** Report-view and select **Results Configuration** from the context-menu.
2. In the **General** page enter a number between 1-10.
3. Select **OK** to confirm or **Cancel** to abort the function.

Note:

- The Results View may display GPS and Level results.

Keep a Processing Run

Normally a minimum number of processing runs is retained. If the number of processing runs exceeds the number set in [Results Configuration](#) the oldest processing run is automatically deleted. To prevent a particular run from being automatically deleted, its Keep Status can be set to 'Yes'.

- Right-click on a processing run in the Tree-View or Report-View and select **Keep**.

Delete a Processing Run

Enables you to manually delete a processing run.

- Right-click on a processing run in the Tree-View or Report-View and select **Delete**.

Note:

- If you delete a Processing Run, the stored results will not be deleted.

View Configuration

Enables you to configure the content of the Report-View of Baselines or Points. Per default all items are enabled.

1. In the Results Tree-View select **Baselines** or **Points**.
2. In the Report-View right-click on a column heading and select **View Configuration**.
3. Check the items that shall be displayed.
4. Press **OK** to confirm or **Cancel** to abort the function.

Alternatively:

- Click the  **Configure view** button of the **Results** Toolbar.

Configure a Report

All reports for which report templates can be defined in the [Report Template Management](#) can be configured by:

- modifying the currently active report template properties or by
- selecting a different report template.

To modify the currently active report template:

1. To modify the currently active [Report Template](#) open the report and select **Properties...** from the context menu or click  in the **Reports** toolbar.
2. Change the [Report Template Properties](#) to modify contents and format of the report.

Alternatively, you can modify report templates in the [Report Template Management](#) component.

To select a different report template:

- To select a different [Report Template](#) open the report and select a different report template from the combo-box of the **Reports** toolbar. Only report templates which match the report type will show up in the combo-box.

Use the [Report Template Management](#) to define [new report templates](#).

To show or hide the table of contents of a report click on  in the **Reports** toolbar. A table of contents can only be displayed if **Include TOC** has been selected in the [Report Template Properties: General](#) page.

GPS Results

GPS-Processing Results: Baseline

The following items are listed in the Report-View upon selecting **Baselines** from the Tree-View in the **Results** tab:

Reference Id

Reference Station Identification

Rover Id

Rover Station Identification

Stored Status

Indicates whether the baseline has been stored to the data base.

See also: [Store the GPS-Processing Results](#)

Ambiguity Status

Indicates whether the Ambiguities for this baseline have been resolved. Ambiguities can only be resolved if Code and Phase measurements have been processed, and the baseline length is within the limitation set under "Fix ambiguities up to" in [GPS-processing Parameters: Strategy](#).

GNSS Type

Satellite systems used may be either **GPS** or **GPS/GLONASS** or **GPS/Galileo** or **GPS/GLONASS/Galileo**, independent of the solution type used for the final computation.

Start

Time of first common epoch

End

Time of last common epoch

Duration

Time between first and last common epoch

Type

Type of operation (observation)

Solution type

Solution Type used for processing. If **Automatic** has been selected as [Processing Parameter](#), then the solution type used in the background is displayed. This can be either **Phase** (*all fix* or *GPS fix*, *GLONASS float*) or **Code** or **Float**.

Frequency

Frequency used for processing. If **Automatic** has been selected as [Processing Parameter](#), then the Frequency used in the background is displayed. This can be either **L1/E1** or **L2** or **L1/E1+L2** or **iono free (L3)**.

DX, DY, DZ or Lat, Long, Height

Baseline vector components in Cartesian or Geodetic format

Posn. Qlty

RMS of the standard deviations of the two position elements

Hgt. Qlty

The Height Quality is equal to the standard deviation of the height element

Posn. + Hgt. Qlty

RMS of the standard deviations of the position and height elements

Slope Distance

Slope distance between rover and reference

Sd. Slope Distance

Standard deviation of the slope distance

Ref. Ant Hgt.

Antenna height of the Reference.

Rov. Ant. Hgt

Antenna height of the Rover.

Sd.X, Sd.Y, Sd.Z

Standard deviation for each coordinate component

M0, Q11-Q33

Elements of Qxx-matrix

DOP values

In these columns the **minimum** and **maximum** values for GDOP, PDOP, HDOP and VDOP of all processed epochs are displayed. Note that for these columns to be filled the computation of DOP values has to be selected in the [GPS-processing Parameters: Extended Output](#) page.

GPS-Processing Results: Points

The following items are listed in the Report-View upon selecting **Points** from the Tree-View in the **Results** tab:

Point Id

Point Identification

Epoch

Date and time of the first observation epoch of this point

Stored Status

Indicates whether the Point has been stored to the data base.

See also: [Store the GPS-processing Results](#)

Ambiguity Status

Indicates whether the Ambiguities for this baseline have been resolved. Ambiguities can only be resolved if Code and Phase measurements have been processed, and the baseline length is within the limitation set under "Fix ambiguities up to" see [GPS-processing Parameters: Strategy](#).

GNSS Type

Satellite systems used may be either **GPS** or **GPS/GLONASS** or **GPS/Galileo** or **GPS/GLONASS/Galileo**, independent of the solution type used for the final computation.

Type

Type of operation (observation)

Solution type

Solution Type used for processing. If **Automatic** has been selected as [Processing Parameter](#), then the solution type used in the background is displayed. This can be either **Phase** (*all fix* or *GPS fix*, *GLONASS float*) or **Code** or **Float**.

Frequency

Frequency used for processing. If **Automatic** has been selected as [Processing Parameter](#), then the Frequency used in the background is displayed. This can be either **L1/E1** or **L2** or **L1/E1+L2** or **iono free(L3)**.

X, Y, Z or Lat, Long, Height

Point coordinates in cartesian or geodetic format

Posn. Qlty

RMS of the standard deviations of the two position elements

Hgt. Qlty

Standard deviation of the height element

Posn. + Hgt. Qlty

RMS of the standard deviations of the position and height elements

Antenna Hgt.

Antenna height

Sd.X, Sd.Y, Sd.Z or Sd Lat, Sd Long...

Standard deviation for each coordinate component

M0, Q11-Q33

Elements of Qxx-matrix

DOP values

In these columns the **minimum** and **maximum** values for GDOP, PDOP, HDOP and VDOP of all processed epochs are displayed. Note that for these columns to be filled the computation of DOP values has to be selected in the [GPS-processing Parameters: Extended Output](#) page.

Selection Criteria

This Property Sheet enables you to specify the filter criteria for selecting the baseline results to be stored.

1. In the Results Tree-View select **Baselines** or **Points**.
2. In the corresponding Report-View right-click and select **Selection Criteria...** from the context-menu.
3. Check the desired boxes to make your selection. To switch between pages use the following tabs:

General: Enables you to define *Quality* thresholds and/or select baselines that meet the *Ambiguity Status* requirements.

Point Type: Enables you to select baselines that meet the Point Type requirement.

Moving Points: If you enable *Moving* in the previous page you may additionally define a distance criteria between consecutive points.

4. Select **OK** to confirm or **Cancel** to abort the function.

Note:

- If you select more than one argument, the baseline has to comply with all of them to be selected using criteria.
- To change the selection criteria permanently refer to [Default Selection Criteria](#).

Default Selection Criteria

Enables you to permanently change the filter criteria for selecting baselines using criteria.

1. In the **Points** or **Baselines** Report-view or in the background of the Tree-View right-click and select **Default Selection Criteria**. Alternatively select **Default Selection Criteria** from the Results main menu.
2. Enter the parameters as described in [Selection Criteria](#).
3. Select **OK** to confirm or **Cancel** to abort the function.

GPS-Processing Parameters

Select the computation parameters before you start your computation. The parameters can be changed individually, but system default settings are also available for all parameters.

After the computation has been performed the GPS-Processing Parameter settings used for the particular computation run are listed in the Results Manager and may also be output via a report.

How to modify GPS-processing Parameters

The GPS-processing Parameter Property-Sheet consists of the following pages:

[General](#)

[Auto. Processing](#)

In the **General** page an option called 'Show advanced parameters' may be ticked, which then offers you access to two further pages:

[Strategy](#)

[Extended Output](#)



If this option has been ticked when configuring the default processing parameters under **Tools – Options**, then these two tabs will by default be visible.

GPS-processing Reports

For each GPS-processing run a set of results can be created. A **Summary Report** and **individual reports** for all baselines (and SPP computations) can be generated.



The GPS-processing reports can either be displayed embedded into the right-hand pane of the Results View or as stand-alone reports in separate windows. Several stand-alone reports can be displayed at the same time. All stand-alone reports are then listed in the **Open Documents** list bar.

Summary Reports:

- To display the **GPS Summary Report** embedded in the Results View click on the  **Report** folder in the tree view.
- To open the GPS Summary Report in a separate window right click on the  **Report** folder in the tree-view or inside the embedded report and select **Open Report** from the context menu.

To configure the contents of the Summary Report modify the corresponding report template or create and select a new report template. For further details see: [Configure a Report](#).

Individual Reports:

- To display an individual report embedded in the Results View open the  **Report** folder in the tree view and select the corresponding baseline or SPP result.
- To open an individual report in a separate window open the  **Report** folder in the tree-view and right-click on the corresponding baseline or SPP result and select **Open Report** from the context menu. Alternatively, right-click inside the embedded report and select **Open Report**.

Depending on whether you have processed static baselines, kinematic baselines or SPP the contents of the individual reports vary. To configure the contents of the individual reports modify the corresponding report template or create and select a new report template. For further details see: [Configure a Report](#).

To learn more about the different Report Types select from the list below:

[GPS Processing Report: Summary](#)



[GPS Processing Report: Baselines](#)

[GPS Processing Report: Kinematic](#)

[GPS Processing Report: SPP](#)

GPS Processing Report: Summary

To get an overview on the processing results for each processing run you may invoke the **Processing Summary Report**.

- In the **Results** Tree View open the node  of the current processing run and click on  **Report**. In the right-hand pane of the **Results View** the GPS Processing Summary report opens as an embedded report.

Embedded reports can be saved as HTML files, printed or opened in a stand-alone window:

- To save a report as an HTML file right-click inside the report and select **Save As...**
- To print a report right-click inside the report and select **Print**. A **Print Preview** is also available from the context menu.
- To open the GPS Results Summary Report in a stand-alone window right-click inside the report and select **Open Report**. The report will then be listed in the **Open Documents list bar**.
- To select the contents and the layout of the report refer to: [Configure a Report](#)

When the report has been configured to display all possible sections it presents you with the following information:

- [Project Information](#)
- [Processing Parameters](#)
- [SPP](#) (only if at least one SPP calculation has been included in the computation)
- [Static baselines](#) (only if at least one static baseline calculation has been included in the computation)
- [Kinematic tracks](#) (only if at least one kinematic or mixed track has been included in the computation)

Project Information

[Example:](#)

Project Information

Project name:	Kinematic Example
Date created:	02/02/2003 20:36:14
Time zone:	0h 00'
Coordinate System name:	WGS 1984
Application software:	Leica SKI-Pro 3.0
Start date and time:	09/23/1999 08:03:36
End date and time:	09/23/1999 08:14:21
Occupied points:	8
Moving points:	196
Processing kernel:	PSI-Pro 1 .0

This section gives you general information on the [Project Properties](#), like the project name, creation date and time, the time zone and the attached coordinate system. Start and end time of the processed intervals and the number of processed points (Static, Kinematic, SPP) is displayed as well as the software and the processing kernel version.

If information has been entered in the [Dictionary](#) page of the Project Properties dialog these pieces of information will be added to this section of the report.

Processing Parameters

[Example:](#)

Processing Parameters

Parameters	Selected
Cut-off angle:	15°
Ephemeris type:	Broadcast
Solution type:	Automatic
Frequency:	Automatic
Fix ambiguities up to:	80 km
Min. duration for float solution (static):	5' 00"
Sampling rate:	Use all
Tropospheric model:	Hopfield
Ionospheric model:	Automatic
Use stochastic modelling:	Yes
Min. distance:	8 km
Ionospheric activity:	Automatic

The processing parameters used for the processing run are listed as defined in the GPS-Processing Parameters pages [General](#) and [Strategy](#).

Depending on whether static baselines, kinematic baselines or SPP has been processed one or more of the following 3 subsections will be displayed:

SPP Overview

This section will only be displayed if at least one SPP calculation has been included in the computation.

[Example:](#)

SPP Overview

B215

Receiver type / S/N:	SR530 / 321		
Antenna type / S/N:	AT502 Tripod / -		
Antenna height:	1.3970 m		
Coordinates:			
Latitude:	47° 23' 45.67424" N		
Longitude:	9° 38' 10.54053" E		
Ellip. Hgt.:	452.7014 m		
Solution type:	Code		
Frequency:	ionoFree (L3)		
Time span:	12/21/1998 13:49:45 - 12/21/1998 15:07:15		
Duration:	1h 17' 30"		
Quality:	Sd. Lat: 1.1310 m	Sd. Lon: 0.8795 m	Sd. Hgt: 2.2109 m
	Posn. Qlty: 1.4327 m		
DOPs (min-max):	GDOP: 2.1 - 3.3	PDOP: 1.8 - 2.8	HDOP: 1.1 - 1.3 VDOP: 1.5 - 2.4
Number of used satellites:	GPS: 9	GLONASS: -	

When the report has been **configured** to display all possible sub-sections of the SPP Overview it presents you with the following information for each SPP point:

- Receiver Information: Receiver type and serial number
- Antenna Information: Antenna type and serial number and the antenna height
- Solution Type: Solution type and frequency
- Time Information: Time span and duration of the processed interval
- Quality Information: Standard deviations and quality information for the computed SPP result
- DOPs: Minimum and maximum values for GDOP, PDOP, HDOP and VDOP
- Number of used Satellites (GPS/ GLONASS/ Galileo)

The resulting **SPP coordinates** are given in the **selected coordinate format**.

Baseline Overview

This section will only be displayed if at least one static baseline calculation has been included in the computation.

[Example:](#)

Baseline Overview

B215 - TP214	Reference: B215	Rover: TP214	
Receiver type / S/N:	SR530 / 321	SR530 / 326	
Antenna type / S/N:	AT502 Tripod / -	AT502 Tripod / -	
Antenna height:	1.3970 m	1.4950 m	
Coordinates:			
Latitude:	47° 23' 45.67424" N	47° 23' 51.72460" N	
Longitude:	9° 38' 10.54053" E	9° 37' 11.36637" E	
Ellip. Hgt.:	452.7013 m	453.6012 m	
Solution type:	Phase		
Frequency:	L1 and L2		
Ambiguity:	Yes		
Time span:	12/21/1998 14:01:45 - 12/21/1998 14:11:30		
Duration:	9' 45"		
Quality:	Sd. Lat: 0.0006 m	Sd. Lon: 0.0004 m	Sd. Hgt: 0.0012 m
	Posn. Qlty: 0.0007 m	Sd. Slope: 0.0004 m	
Baseline vector:	dX: 72.5443 m	dY: -1246.3767 m	dZ: 127.1552 m
	Slope: 1254.9446 m	dHgt: 0.0000 m	
DOPs (min-max):	GDOP: 2.7 - 4.0	PDOP: 2.4 - 3.5	HDOP: 1.3 - 2.1
			VDOP: 2.0 - 2.8
Number of used satellites:	GPS: 9	GLONASS: -	

When the report has been **configured** to display all possible sub-sections of the Baseline Overview it presents you with the following information for each static baseline:

- Receiver Information: Type and serial number of reference and rover receiver
- Antenna Information: Type, serial number and antenna height for reference and rover antenna
- Solution Type: Solution type and frequency that were actually used for the processing. Additionally the Ambiguity Status (Yes or No) is displayed
- Time Information: Time span and duration of the processed interval
- Quality Information: Standard deviations and quality information for the computed rover coordinates and for the slope distance
- Vector information: Baseline vector components and slope distance
- DOPs: Minimum and maximum values for GDOP, PDOP, HDOP and VDOP
- Number of used Satellites (GPS/ GLONASS/ Galileo)

The initial coordinates of the reference and the resulting **coordinates** of the rover are given in the **selected coordinate format**.

Kinematic Overview

This section will only be displayed if at least one track of purely kinematic data or a mixed track has been included in the computation.

The Kinematic Overview section consists of two parts:

- General Information about the complete track and
- Separate information for all Manual Points, Automatic Points, Events and Moving Points included in the track.

The General Information section presents you with the following bits of track specific information:

[Example:](#)

Kinematic Overview			
E11 - 12640923_0803360	Reference: E11	Rover:	
Receiver type / S/N:	SR530 / 0	SR530 / 31264	
Antenna type / S/N:	AT502 Tripod / -	AT502 Pole / -	
Antenna height:	2.0030 m		
Reference coordinates:			
Latitude:	37° 55' 55.21011" N		
Longitude:	27° 21' 06.78985" E		
Ellip. Hgt.:	78.8413 m		
Static points:	8		
Moving points:	196		
Time span:	09/23/1999 08:03:36 - 09/23/1999 08:14:21		
Duration:	10' 45"		
DOPs (min-max):	GDOP: 3.4 - 3.6	HDOP: 1.3 - 1.3	VDOP: 2.5 - 2.7
	PDOP: 2.8 - 3.0		
Number of used satellites:	GPS: 6		
	GLONASS: -		

- Receiver Information: Type and serial number of reference and rover receiver
- Antenna Information: Type, serial number and antenna height of reference and rover antenna
- Initial coordinates for the reference
- Number of **manual** points, **automatic** points, **events** and **moving** points.
- Time Information: Time span and duration of the track
- DOPs: Minimum and maximum values for GDOP, PDOP, HDOP and VDOP
- Number of used Satellites (GPS/ GLONASS/ Galileo)

The General Information section is followed by a summary of all

- Manual points
- Automatic points

- Events
- Moving points

contained in the track. Each point type can be **switched on or off** separately. For each point the final coordinates, the antenna height, the solution type, the computed frequency and the ambiguity status is displayed.

[Example:](#)

Static points

6074

Coordinates:

Latitude:	37° 55' 40.61609" N
Longitude:	27° 20' 41.00751" E
Ellip. Hgt.:	249.0007 m

Antenna height: 2.0000 m

Solution type: Phase

Frequency: L1 and L2

Ambiguity: Yes

Time span: 09/23/1999 08:04:51 - 09/23/1999 08:04:54

Duration: 3"

GPS Processing Report: Baselines

To get an overview on the processing results for each **static baseline** you may invoke the **Results - Baseline** Report.

- In the **Results** Tree View click open the  **Report** folder. Click on the  **Baseline** for which you want to inspect the report. In the right-hand pane of the **Results View** the corresponding **Results - Baseline** report opens as an embedded report.

Embedded reports can be saved as HTML files, printed or opened in a stand-alone window:

- To save a report as an HTML file right-click inside the report and select **Save As....**
- To print a report right-click inside the report and select **Print**. A **Print Preview** is also available from the context menu.
- To open the GPS Results Summary Report in a stand-alone window right-click inside the re-port and select **Open Report**. The report will then be listed in the **Open Documents list bar**.
- To select the contents and the layout of the report refer to: [Configure a Report](#)

When the report has been configured to display all possible sections it presents you with the following information:

- [Project Information](#)
- [Point Information](#)
- [Processing Parameters](#)
- [Satellite selection](#)
- [Computed Iono Model](#)
- [Antenna Information](#)
- [Observation statistics](#)
- [Ambiguity statistics](#)
- [Cycle slip statistics](#)
- [Final Coordinates](#)
- [Warning messages](#)

Project Information

[Example:](#)

Project Information

Project name: PP Sample
 Date created: 12/17/2002 14:29:36
 Time zone: 1h 00'
 Coordinate System name: WGS 1984
 Application software: Leica SKI-Pro 3.0
 Processing kernel: PSI-Pro 1.0
 Processed: 02/07/2003 20:02:59

This section gives you general information on the [Project Properties](#), like the project name, creation date and time, the time zone and the attached coordinate system. You also find information on the software and the processing kernel version as well as date and time of the processing run.

If information has been entered in the [Dictionary](#) page of the Project Properties dialog these pieces of information will be added to this section of the report.

Point Information

[Example:](#)

Point Information

	Reference: B215	Rover: TP214	
Receiver type / S/N:	SR530 / 321	SR530 / 326	
Antenna type / S/N:	AT502 Tripod / -	AT502 Tripod / -	
Antenna height:	1.3970 m	1.4950 m	
Initial coordinates:			
Latitude:	47° 23' 45.67424" N	47° 23' 51.74697" N	
Longitude:	9° 38' 10.54053" E	9° 37' 12.30504" E	
Ellip. Hgt.:	452.7013 m	416.3859 m	
Time span:	12/21/1998 14:01:45 - 12/21/1998 14:09:15		
Duration:	7' 30"		
Windows (Exclude):	From	To	Duration
Window 1:	12/21/1998 14:09:20	12/21/1998 14:11:30	2' 09"

This section presents you with the following bits of information on the respective reference and rover points:

- Receiver Information: Type and serial number of reference and rover receiver
- Initial coordinates for reference and rover

If the report has been [configured](#) to display all possible sub-sections of the Point Information it presents you additionally with:

- Antenna Information: Type, serial number and antenna height of reference and rover antenna

- Time Information: Time span and duration of the processed interval are displayed. If an **observation window** has been set for the computed interval, all excluded time periods will be listed.

Processing Parameters

[Example:](#)

Processing Parameters

Parameters	Selected	Used	Comment
Cut-off angle:	15°	15°	
Ephemeris type:	Broadcast	Broadcast	
Solution type:	Automatic	Phase	
Frequency:	Automatic	Automatic	
Fix ambiguities up to:	80 km	80 km	
Min. duration for float solution (static):	5' 00"	5' 00"	
Sampling rate:	Use all	15	
Tropospheric model:	Hopfield	Hopfield	
Ionospheric model:	Computed	None	Switched to using no ionospheric model. At least 45 minutes of dual frequency data are needed to derive a Computed ionospheric model.
Use stochastic modelling:	Yes	Yes	
Min. distance:	8 km	8 km	
Ionospheric activity:	Automatic	Automatic	

The processing parameters which have been **selected** for the processing run in the GPS-Processing Parameters pages **General** and **Strategy** are listed. Additionally, the parameters which have actually been **used** by the processing kernel are displayed. If the processing kernel changed the selected parameters, a **comment** is given to indicate the reason.

Satellite selection

[Example:](#)

Satellite Selection

Manually disabled satellites: SV 21

Satellite Windows (Exclude):

Satellite	From	To	Duration
SV 02	12/21/1998 14:09:01	12/21/1998 14:11:30	2' 29"
SV 26	12/21/1998 14:10:10	12/21/1998 14:11:30	1' 20"

Antenna Information

	Reference: B215	Rover: TP214
Antenna type:	AT502 Tripod	AT502 Tripod
Horizontal offset:	0.0000 m	0.0000 m
Vertical offset:	0.3600 m	0.3600 m
Additional corrections:	Elevation and azimuth	Elevation and azimuth

Phase center offsets	L1 (Reference)	L2 (Reference)	L1 (Rover)	L2 (Rover)
Vertical:	0.0683 m	0.0712 m	0.0683 m	0.0712 m
East:	0.0000 m	0.0000 m	0.0000 m	0.0000 m
North:	0.0000 m	0.0000 m	0.0000 m	0.0000 m

Additional corrections (Reference):

A \ Z	0°	5°	10°	15°	20°	25°	30°	35°	40°	45°	50°	55°	60°	65°	70°	75°	80°	85°	90°
0° L1	-2.7	-2.7	-2.5	-1.6	-0.5	0.0	0.1	0.6	1.4	1.8	1.4	1.1	1.2	0.9	-1.0	-3.8	-5.6	-5.9	-5.7
0° L2	-1.4	-1.0	-0.6	-0.7	-1.1	-1.0	-0.1	0.8	1.5	2.2	3.0	3.1	2.3	0.8	-1.3	-5.1	-11.2	-17.6	-20.4

Additional corrections (Rover):

A \ Z	0°	5°	10°	15°	20°	25°	30°	35°	40°	45°	50°	55°	60°	65°	70°	75°	80°	85°	90°
0° L1	-2.7	-2.7	-2.5	-1.6	-0.5	0.0	0.1	0.6	1.4	1.8	1.4	1.1	1.2	0.9	-1.0	-3.8	-5.6	-5.9	-5.7
0° L2	-1.4	-1.0	-0.6	-0.7	-1.1	-1.0	-0.1	0.8	1.5	2.2	3.0	3.1	2.3	0.8	-1.3	-5.1	-11.2	-17.6	-20.4

This section presents you with the following bits of information for the antennas used on the reference and rover point:

- Antenna type for reference and rover
- Horizontal and Vertical offset for both antennas
- Additional corrections: None or Elevation and azimuth or Spherical harmonics
- Phase center offsets for L1 and L2 in East, North and Vertical for both sites

The report can be [configured](#) to additionally display:

- Additional corrections: For reference and rover antenna [additional corrections](#) which have been applied in L1 and L2 are listed.

Observation statistics

[Example:](#)

Observation Statistics

Number of common epochs:	483
Number of used observations (L1):	2337
Number of rejected observations (L1):	0
Number of used observations (L2):	2337
Number of rejected observations (L2):	0

Tracking Status L1:

Satellite		From	To	Status
SV 05	✓	01/12/2005 11:00:00	01/12/2005 11:37:15	Tracked / Used
	✗	01/12/2005 11:37:15	01/12/2005 13:00:30	No data
SV 15	✗	01/12/2005 11:00:00	01/12/2005 12:51:00	No data
	✓	01/12/2005 12:51:00	01/12/2005 13:00:30	Tracked / Used
SV 16	✗	01/12/2005 11:00:00	01/12/2005 11:20:30	No data
	✓	01/12/2005 11:20:30	01/12/2005 13:00:30	Tracked / Used
SV 17	✓	01/12/2005 11:00:00	01/12/2005 12:57:15	Tracked / Used
	✗	01/12/2005 12:57:15	01/12/2005 13:00:30	No data

For each GNSS system used this section gives you a statistical overview on

- the number of processed epochs
- the total number of used observations: if code and phase observations have been used only the phase observations are counted.
- the total number of rejected observations

The report can be **configured** to additionally display the:

- Tracking Status: The status whether a satellite has been **tracked** and **used** ✓ or whether it has been **tracked** but **rejected** ✗ or whether it has **no data** ✗ and the corresponding time span are given for each satellite on L1 and L2. G denotes GPS satellites, R denotes GLONASS satellites and E denotes Galileo satellites.
- Tracking Status (Graphics): For all satellites the Tracking Status on L1, L2 and L5 (if used) is displayed in a graphical summary.

[Example:](#)

Tracking Summary:

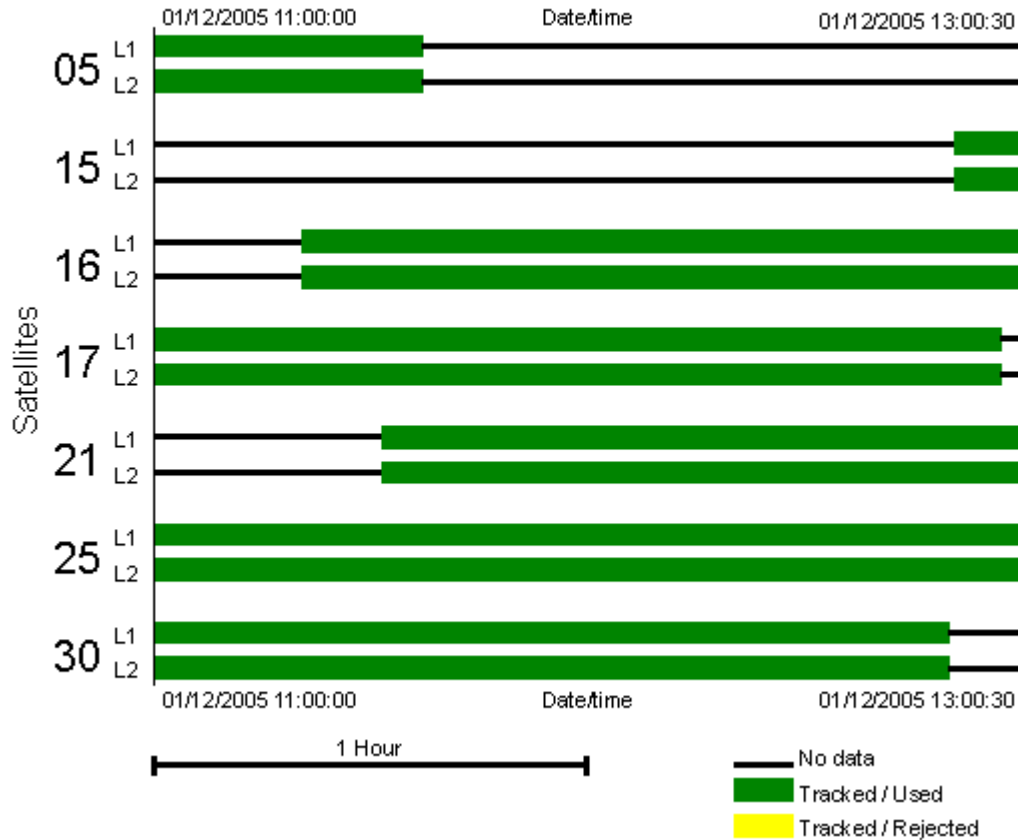

- Right-click into the graphics to get access to functionality like **Zoom In/ Zoom Out**, **Copy** the graphics or **Save** the graphics **as....**

To zoom in to the graphics may be especially useful for detailed inspection of long observation intervals. To zoom back to the original size select **Original View** from the context menu.

Note: If the elevation of a processed satellite drops below the cut-off angle defined in the GPS-Processing Parameters: **General** page or if a **satellite window** has been set, then these epochs will also be marked as **no data** ❌.

If GLONASS ambiguities were not resolved but kept at their float values then these epochs will be marked as **tracked but rejected** ❌.

Ambiguity statistics

LGO searches for all possible combinations of ambiguities. Rigorous statistical techniques are used to determine the “most probably correct” solution and the “second most probably correct” solution. These two “most probable” solutions are then compared and if the probability that the first solution is much more likely to be correct than the second solution then the first solution is taken as the correct answer.

Immediately after having completed the ambiguity search routine and having computed the most likely ambiguities with one set of GPS observations, the whole ambiguity search routine is repeated using a different set of GPS observations. This results in a second set of ambiguities.

The ambiguities computed in this second search routine are then compared with the ambiguities computed in the first ambiguity search. If the two sets of ambiguities are identical, then the ambiguities are considered to be correct. In order to ensure the highest possible reliability the ambiguity search routine is continually repeated for the entire observation interval. Some of the values presented in the report refer to this strategy of repeated ambiguity searches.

[Example:](#)

Ambiguity Statistics

Total number of ambiguities: 34
 Number of fixed ambiguities: 14
 Number of independent fixes: 38
 Avg. time between independent fixes: 12"

Percentage of fixed epochs (L1): 94%
 Percentage of fixed epochs (L2): 94%
 Percentage of fixed epochs (overall): 93%

Overall Statistic:

Status	From	To	Duration
Not fixed	09/23/1999 08:03:36	09/23/1999 08:04:21	45"
Fixed	09/23/1999 08:04:21	09/23/1999 08:14:21	10' 00"

This section gives you a statistical overview on the:

- **Total number of ambiguities:**
For each satellite and each frequency an integer ambiguity needs to be resolved. Ambiguities which needed to be re-initialised will also be counted. The number is given separately for GPS and for GLONASS (or Galileo) satellites.
- **Number of fixed ambiguities:**
Number of ambiguities which have finally been resolved. The number is given separately for GPS and for GLONASS (or Galileo) satellites.
- **Number of independent fixes:**
Number of how often an independent ambiguity search routine has successfully been completed leading to a confirmation of previously calculated ambiguity values.
- **Time between independent fixes on average**
- **Percentage of fixed epochs (L1) and (L2):**
Percentage of epochs (calculated for all satellites) for which L1 respectively L2 ambiguities have been resolved. Note that in case an ambiguity could not be resolved for a specific satellite or a specific frequency this number can be below 100% even if the overall percentage of fixed epochs is 100%.
If the data contains L5 observations then additionally the percentage for L5 ambiguities is displayed.
- **Percentage of fixed epochs (overall):**
Percentage of all epochs for which a successful ambiguity resolution has been available. This corresponds to the percentage of epochs for which a fixed solution would be available if the data was calculated in a kinematic mode. Note that for static intervals the overall ambiguity resolution can be successful (Amb=Yes) even if this percentage is below 100%.

as well as an

- Overall Statistic:**
 This overview lists the time periods for which ambiguities have successfully been resolved and confirmed to be correct as well as the periods when no ambiguity resolution has been available.

Note that GLONASS ambiguities will only be tried to be resolved if a receiver from a known manufacturer has been used, i.e if the receiver type is known.

Cycle slip statistics

[Example:](#)

Cycle Slip Statistics

Total number of cycle slips: 22

Time	Satellite	Frequency	Slip value	Flags
11/09/1998 09:22:45	SV 24	L2	4.00	flagged
11/09/1998 09:43:00	SV 27	L2	13.00	flagged
11/09/1998 09:47:30	SV 10	L2	-6.00	flagged
11/09/1998 09:58:15	SV 04	L2	19.00	ucs
11/09/1998 09:58:15	SV 10	L2	19.00	ucs
11/09/1998 09:58:15	SV 13	L2	19.00	ucs
11/09/1998 09:58:15	SV 16	L2	19.00	ucs

Cycle slips are discontinuities in the integer ambiguities resulting from signal interruptions. LGO will typically detect and if possible repair them. This section of the report presents you with the total number of cycle slips for the selected baseline. For each cycle slip the **Time**, the **Satellite number**, the **Frequency** (L1 or L2) and the total **Slip value** are listed. 'G' denotes GPS satellites, 'R' denotes GLONASS satellites and 'E' denotes Galileo satellites. The following flags may additionally be displayed:

Ucs: Unflagged cycle slip. The cycle slip was not flagged in the data but was found by LGO.

Ria: Re-initialised ambiguity. The cycle slip could not be fixed and the ambiguity search was re-initialised afterwards.

Final Coordinates

[Example:](#)

Final Coordinates

	Reference: B215	Rover: TP214	
Coordinates:			
Latitude:	47° 23' 45.67424" N	47° 23' 51.72460" N	
Longitude:	9° 38' 10.54053" E	9° 37' 11.36637" E	
Ellip. Hgt.:	452.7013 m	453.6011 m	
Solution type:	Phase		
Frequency:	L1 and L2		
Ambiguity:	Yes		
Quality:	Sd. Lat: 0.0006 m	Sd. Lon: 0.0004 m	Sd. Hgt: 0.0012 m
	Posn. Qty: 0.0007 m	Sd. Slope: 0.0004 m	
M0:	0.3580 m		
Cofactor Matrix Q _{xx} :	0.00000251	-0.00000015	0.00000049
		0.00000105	-0.00000060
			0.00001148
Baseline vector:	dX: 72.5442 m	dY: -1246.3767 m	dZ: 127.1552 m
	Slope: 1254.9446 m	dHgt: 0.8998 m	
DOPs (min-max):	GDOP: 2.8 - 4.0	HDOP: 1.3 - 2.1	VDOP: 2.1 - 2.8
	PDOP: 2.4 - 3.5		
Number of used satellites:	GPS: 9	GLONASS: -	

This section presents you with the final coordinates computed for reference and rover.

If the report has been **configured** to display all possible sub-sections of the Final Coordinates section it presents you with:

- Solution Type: Solution Type, used Frequency and Ambiguity status (yes or no) for the selected baseline
- Quality Information: Standard deviations for the computed baseline vector and position quality of the final coordinates
- Variance-covariance matrix: M₀ and Cofactor Matrix Q_{xx}
- Vector Information: Coordinate differences and slope distance of the baseline vector
- DOPs: Minimum and maximum values for GDOP, PDOP, HDOP and VDOP
- Number of used Satellites (GPS/ GLONASS/ Galileo)

Warning messages

This section presents you with all the various warning and error messages that may have been encountered during the processing run. Critical error messages may additionally be displayed in one of the other sub-sections of the report.

Note: Error or warning messages which result in a change of the selected processing parameters will additionally be displayed in the **Comment** column of the **Processing Parameters** section of the report.

GPS Processing Report: Kinematic

To get an overview on the processing results for each **kinematic or mixed track** you may invoke the **Results - Kinematic** Report.

- In the **Results** Tree View click open the  **Report** folder. Click on the  **Track** for which you want to inspect the report. In the right-hand pane of the **Results View** the corresponding **Results - Kinematic** report opens as an embedded report.

Embedded reports can be saved as HTML files, printed or opened in a stand-alone window:

- To save a report as an HTML file right-click inside the report and select **Save As....**
- To print a report right-click inside the report and select **Print**. A **Print Preview** is also available from the context menu.
- To open the GPS Results Summary Report in a stand-alone window right-click inside the re-port and select **Open Report**. The report will then be listed in the **Open Documents list bar**.
- To select the contents and the layout of the report refer to: [Configure a Report](#)

When the report has been configured to display all possible sections it presents you with the following information:

- [Project Information](#)
- [Point Information](#)
- [Processing Parameters](#)
- [Satellite selection](#)
- [Computed Iono Model](#)
- [Antenna Information](#)
- [Observation statistics](#)
- [Ambiguity statistics](#)
- [Cycle slip statistics](#)
- [Final coordinates / manual](#)
- [Final coordinates / automatic](#)
- [Final coordinates / events](#)
- [Final coordinates / moving](#)
- [Warning messages](#)

Project Information

[Example:](#)

Project Information

Project name: PP Sample
 Date created: 12/17/2002 14:29:36
 Time zone: 1h 00'
 Coordinate System name: WGS 1984
 Application software: Leica SKI-Pro 3.0
 Processing kernel: PSI-Pro 1.0
 Processed: 02/07/2003 20:02:59

This section gives you general information on the [Project Properties](#), like the project name, creation date and time, the time zone and the attached coordinate system. You also find information on the software and the processing kernel version as well as date and time of the processing run.

If information has been entered in the [Dictionary](#) page of the Project Properties dialog these pieces of information will be added to this section of the report.

Point Information

Example:

Point Information

E11	Reference: E11	Rover: -
Receiver type / S/N:	SR530 / 0	SR530 / 31264
Antenna type / S/N:	AT502 Tripod / -	AT502 Pole / -
Antenna height:	2.0030 m	-
Initial coordinates:		
Latitude:	37° 55' 55.21011" N	-
Longitude:	27° 21' 06.78985" E	-
Ellip. Hgt.:	78.8413 m	-
Static points:	8	
Moving points:	196	
Time span:	09/23/1999 08:03:36 - 09/23/1999 08:14:21	
Duration:	10' 45"	

This section presents you with the following bits of information on reference and rover:

- Receiver Information: Type and serial number of reference and rover receiver
- Initial coordinates for the reference
- Number of static points, automatic points, events and moving points

If the report has been **configured** to display all possible sub-sections of the Point Information it presents you additionally with:

- Antenna Information:** Type and serial number of reference and rover antenna. Antenna height for the reference and for the moving part of the track. Note that the antenna heights for the points inside the track are given in the section **Final Coordinates**.
- Time Information:** Time span and duration of the processed track are displayed. If an **observation window** has been set for the computed interval, all excluded time periods will be listed.

Processing Parameters

[Example:](#)

Processing Parameters

Parameters	Selected	Used	Comment
Cut-off angle:	15°	15°	
Ephemeris type:	Broadcast	Broadcast	
Solution type:	Automatic	Phase	
Frequency:	Automatic	Automatic	
Fix ambiguities up to:	80 km	80 km	
Min. duration for float solution (static):	5' 00"	5' 00"	
Sampling rate:	Use all	15	
Tropospheric model:	Hopfield	Hopfield	
Ionospheric model:	Computed	None	Switched to using no ionospheric model. At least 45 minutes of dual frequency data are needed to derive a Computed ionospheric model.
Use stochastic modelling:	Yes	Yes	
Min. distance:	8 km	8 km	
Ionospheric activity:	Automatic	Automatic	

The processing parameters which have been **selected** for the processing run in the GPS-Processing Parameters pages **General** and **Strategy** are listed. Additionally, the parameters which have actually been **used** by the processing kernel are displayed. If the processing kernel changed the selected parameters, a **comment** is given to indicate the reason.

Satellite selection

[Example:](#)

Satellite Selection

Manually disabled satellites: SV 21

Satellite Windows (Exclude):

Satellite	From	To	Duration
SV 02	12/21/1998 14:09:01	12/21/1998 14:11:30	2' 29"
SV 26	12/21/1998 14:10:10	12/21/1998 14:11:30	1' 20"

This section lists all satellites which have been manually disabled for the processing run. G denotes GPS satellites, R denotes GLONASS satellites and E denotes Galileo satellites. If [satellite windows](#) have been set this section lists all satellite windows excluded from the computation.

Computed Iono Model

Example:

Computed Iono Model

Number of computed models: 1
 Sampling rate of iono model: 30 sec
 Height of single layer: 350 km

Model 1:

Origin of development: Latitude: 47° 23' 45.67424" N
 Longitude: 9° 38' 10.54053" E
 Time (UT): 12/21/1998 12:49:45

Validity: From epoch: 12/21/1998 13:50:00
 To epoch: 12/21/1998 15:07:00

Coefficients:	Deg. Lat	Deg. time	Value	rms
	0	0	2.09282651	0.01482478
	0	1	-0.54429122	0.01305677
	0	2	-0.21284741	0.02082692
	1	0	-0.52033916	0.01267640
	1	1	0.18894276	0.01585076

If a Computed Iono model has been selected in the GPS-Processing parameters [Strategy](#) page, then the results of the iono model are displayed in this section. The computed iono model is a two-dimensional Taylor series expansion in latitude and in (sun-fixed) longitude of the Total Electron Content. The point and the time for which the model is calculated is given as well as the time period for which the model is valid. A fixed number of 5 coefficients is calculated and the values are given together with their rms values.

Antenna Information

Example:

Antenna Information

	Reference: B215	Rover: TP214
Antenna type:	AT502 Tripod	AT502 Tripod
Horizontal offset:	0.0000 m	0.0000 m
Vertical offset:	0.3600 m	0.3600 m
Additional corrections:	Elevation and azimuth	Elevation and azimuth

Phase center offsets	L1 (Reference)	L2 (Reference)	L1 (Rover)	L2 (Rover)
Vertical:	0.0683 m	0.0712 m	0.0683 m	0.0712 m
East:	0.0000 m	0.0000 m	0.0000 m	0.0000 m
North:	0.0000 m	0.0000 m	0.0000 m	0.0000 m

Additional corrections (Reference):

A \ Z	0°	5°	10°	15°	20°	25°	30°	35°	40°	45°	50°	55°	60°	65°	70°	75°	80°	85°	90°
0° L1	-2.7	-2.7	-2.5	-1.8	-0.5	0.0	0.1	0.6	1.4	1.8	1.4	1.1	1.2	0.9	-1.0	-3.8	-5.6	-5.9	-5.7
0° L2	-1.4	-1.0	-0.6	-0.7	-1.1	-1.0	-0.1	0.8	1.5	2.2	3.0	3.1	2.3	0.8	-1.3	-5.1	-11.2	-17.6	-20.4

Additional corrections (Rover):

A \ Z	0°	5°	10°	15°	20°	25°	30°	35°	40°	45°	50°	55°	60°	65°	70°	75°	80°	85°	90°
0° L1	-2.7	-2.7	-2.5	-1.6	-0.5	0.0	0.1	0.6	1.4	1.8	1.4	1.1	1.2	0.9	-1.0	-3.8	-5.6	-5.9	-5.7
0° L2	-1.4	-1.0	-0.6	-0.7	-1.1	-1.0	-0.1	0.8	1.5	2.2	3.0	3.1	2.3	0.8	-1.3	-5.1	-11.2	-17.6	-20.4

This section presents you with the following bits of information for the antennas used on the reference and rover point:

- Antenna type for reference and rover
- Horizontal and Vertical offset for both antennas
- Additional corrections: None or Elevation and azimuth or Spherical harmonics
- Phase center offsets for L1 and L2 in East, North and Vertical for both sites

The report can be [configured](#) to additionally display:

- Additional corrections: For reference and rover antenna [additional corrections](#) which have been applied in L1 and L2 are listed.

Observation statistics

Example:

Observation Statistics

Number of common epochs:	483
Number of used observations (L1):	2337
Number of rejected observations (L1):	0
Number of used observations (L2):	2337
Number of rejected observations (L2):	0

Tracking Status L1:

Satellite		From	To	Status
SV 05	✓	01/12/2005 11:00:00	01/12/2005 11:37:15	Tracked / Used
	✗	01/12/2005 11:37:15	01/12/2005 13:00:30	No data
SV 15	✗	01/12/2005 11:00:00	01/12/2005 12:51:00	No data
	✓	01/12/2005 12:51:00	01/12/2005 13:00:30	Tracked / Used
SV 16	✗	01/12/2005 11:00:00	01/12/2005 11:20:30	No data
	✓	01/12/2005 11:20:30	01/12/2005 13:00:30	Tracked / Used
SV 17	✓	01/12/2005 11:00:00	01/12/2005 12:57:15	Tracked / Used
	✗	01/12/2005 12:57:15	01/12/2005 13:00:30	No data

For each GNSS system used this section gives you a statistical overview on

- the number of processed epochs
- the total number of used observations: if code and phase observations have been used only the phase observations are counted.
- the total number of rejected observations

The report can be **configured** to additionally display the:

- Tracking Status: The status whether a satellite has been **tracked** and **used** ✓ or whether it has been **tracked** but **rejected** ✗ or whether it has **no data** ✗ and the corresponding time span are given for each satellite on L1 and L2. G denotes GPS satellites, R denotes GLONASS satellites and E denotes Galileo satellites.
- Tracking Status (Graphics): For all satellites the Tracking Status on L1, L2 and L5 (if used) is displayed in a graphical summary.

[Example:](#)

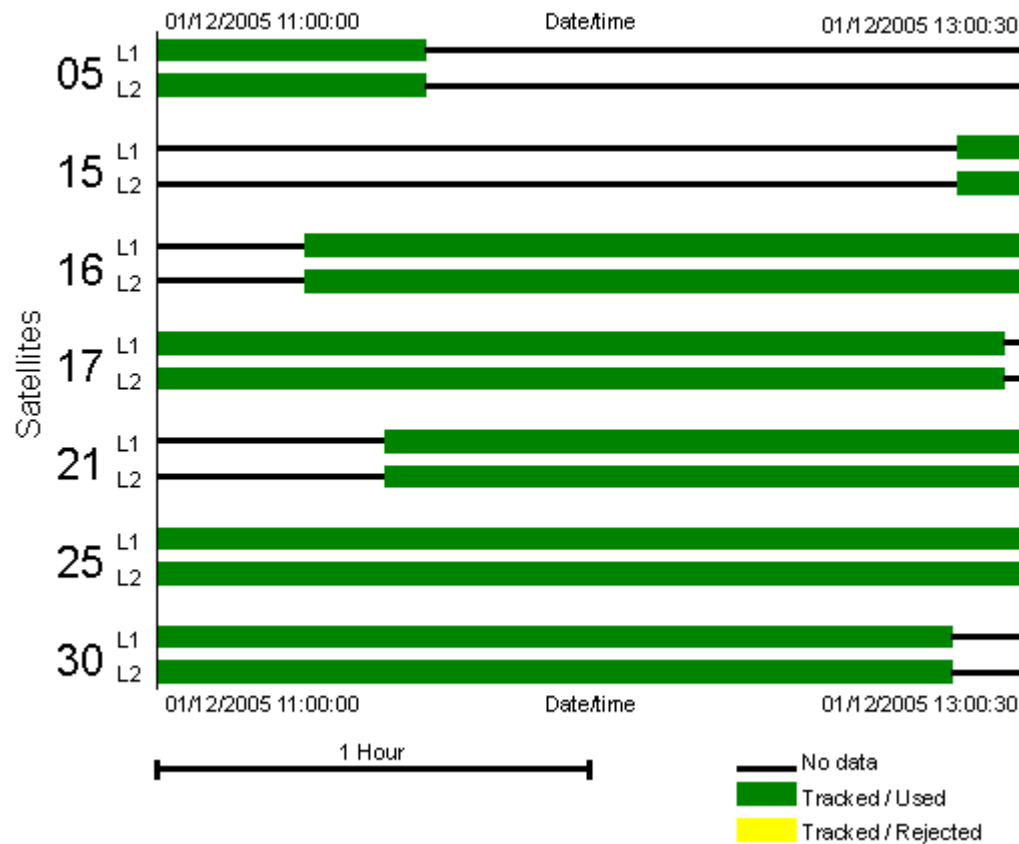
Tracking Summary:

- Right-click into the graphics to get access to functionality like **Zoom In/ Zoom Out**, **Copy** the graphics or **Save** the graphics **as....**

To zoom in to the graphics may be especially useful for detailed inspection of long observation intervals. To zoom back to the original size select **Original View** from the context menu.

Note: If the elevation of a processed satellite drops below the cut-off angle defined in the GPS-Processing Parameters: [General](#) page or if a [satellite window](#) has been set, then these epochs will also be marked as **no data** ❌.

If GLONASS ambiguities were not resolved but kept at their float values then these epochs will be marked as **tracked but rejected** ❌.

Ambiguity statistics

LGO searches for all possible combinations of ambiguities. Rigorous statistical techniques are used to determine the “most probably correct” solution and the “second most probably correct” solution. These two “most probable” solutions are then compared and if the probability that the first solution is much more likely to be correct than the second solution then the first solution is taken as the correct answer.

Immediately after having completed the ambiguity search routine and having computed the most likely ambiguities with one set of GPS observations, the whole ambiguity search routine is repeated using a different set of GPS observations. This results in a second set of ambiguities.

The ambiguities computed from this second search routine are then compared with the ambiguities computed from the first ambiguity search. If the two sets of ambiguities are identical, then the ambiguities are considered to be

correct. In order to ensure the highest possible reliability the ambiguity search routine is continually repeated for the entire observation interval. Some of the values presented in the report refer to this strategy of repeated ambiguity searches.

[Example:](#)

Ambiguity Statistics

Total number of ambiguities:	34
Number of fixed ambiguities:	14
Number of independent fixes:	38
Avg. time between independent fixes:	12"
Percentage of fixed epochs (L1):	94%
Percentage of fixed epochs (L2):	94%
Percentage of fixed epochs (overall):	93%

Overall Statistic:

Status	From	To	Duration
Not fixed	09/23/1999 08:03:36	09/23/1999 08:04:21	45"
Fixed	09/23/1999 08:04:21	09/23/1999 08:14:21	10' 00"

This section gives you a statistical overview on the:

- **Total number of ambiguities:**
For each satellite and each frequency an integer ambiguity needs to be resolved. Ambiguities which needed to be re-initialised will also be counted. The number is given separately for GPS and for GLONASS (or Galileo) satellites.
- **Number of fixed ambiguities:**
Number of ambiguities which have finally been resolved. The number is given separately for GPS and for GLONASS (or Galileo) satellites.
- **Number of independent fixes:**
Number of how often an independent ambiguity search routine has successfully been completed leading to a confirmation of previously calculated ambiguity values.
- **Time between independent fixes on average**
- **Percentage of fixed epochs (L1) and (L2):**
Percentage of epochs (calculated for all satellites) for which L1 respectively L2 ambiguities have been resolved. Note that in case an ambiguity could not be resolved for a specific satellite or a specific frequency this number can be below 100% even if the overall percentage of fixed epochs is 100%.
If the data contains L5 observations then additionally the percentage for L5 ambiguities is displayed.
- **Percentage of fixed epochs (overall):**
Percentage of all epochs for which a successful ambiguity resolution has been available. This corresponds to the percentage of epochs for which a fixed solution would be available if the data was calculated in a kinematic mode. Note that for static intervals the overall ambiguity resolution can be successful (Amb=Yes) even if this percentage is below 100%.

as well as an

- **Overall Statistic:**
This overview lists the time periods for which ambiguities have successfully been resolved and

confirmed to be correct as well as the periods when no ambiguity resolution has been available.

Note that GLONASS ambiguities will only be tried to be resolved if a receiver from a known manufacturer has been used, i.e if the receiver type is known.

Cycle slip statistics

Example:

Cycle Slip Statistics

Total number of cycle slips: 22

Time	Satellite	Frequency	Slip value	Flags
11/09/1998 09:22:45	SV 24	L2	4.00	flagged
11/09/1998 09:43:00	SV 27	L2	13.00	flagged
11/09/1998 09:47:30	SV 10	L2	-6.00	flagged
11/09/1998 09:58:15	SV 04	L2	19.00	ucs
11/09/1998 09:58:15	SV 10	L2	19.00	ucs
11/09/1998 09:58:15	SV 13	L2	19.00	ucs
11/09/1998 09:58:15	SV 16	L2	19.00	ucs

Cycle slips are discontinuities in the integer ambiguities resulting from signal interruptions. LGO will typically detect and if possible repair them. This section of the report presents you with the total number of cycle slips for the selected baseline. For each cycle slip the **Time**, the **Satellite number**, the **Frequency** (L1 or L2) and the total **Slip value** are listed. 'G' denotes GPS satellites, 'R' denotes GLONASS satellites and 'E' denotes Galileo satellites. The following flags may additionally be displayed:

Ucs: Unflagged cycle slip. The cycle slip was not flagged in the data but was found by LGO.

Ria: Re-initialised ambiguity. The cycle slip could not be fixed and the ambiguity search was re-initialised afterwards.

Final Coordinates

This section starts with the following general information which is specific for the complete track:

- Initial coordinates for the reference
- Antenna height for the reference
- Number of manual points, automatic points, events and moving points.
- Time span and duration of the track
- DOPs: Minimum and maximum values for GDOP, PDOP, HDOP and VDOP
- Number of used Satellites (GPS/ GLONASS/ Galileo)

Example:

E11 - 12640923_0803360 Reference: E11

Reference coordinates:

Latitude: 37° 55' 55.21011" N
Longitude: 27° 21' 06.78985" E
Ellip. Hgt.: 78.8413 m

Antenna height (Reference): 2.0030 m

Static points: 8

Moving points: 196

Time span: 09/23/1999 08:03:36 - 09/23/1999 08:14:21

Duration: 10' 45"

DOPs (min-max): GDOP: 3.8 - 4.4 PDOP: 3.4 - 4.0 HDOP: 2.7 - 3.4 VDOP: 2.1 - 2.3

Number of used satellites: GPS: 9
GLONASS: -

The General Information section is followed by a summary of all points contained in the track. This section can be configured separately for all of the following point types contained in the kinematic track:

- Manually occupied points
- Automatically recorded points
- Events
- Moving epochs

[Example:](#)

Static points

mo70	07/12/1995 18:19:02		
Coordinates:			
Latitude:	47° 24' 32.46532" N		
Longitude:	9° 37' 02.50773" E		
Ellip. Hgt.:	451.6804 m		
Antenna height:	1.9000 m		
Solution type:	Phase		
Frequency:	L1 and L2		
Ambiguity:	Yes		
Quality:	Sd. Lat: 0.0033 m	Sd. Lon: 0.0024 m	Sd. Hgt: 0.0067 m
	Posn. Qlty: 0.0041 m	Sd. Slope: 0.0026 m	
M0:	0.3240 m		
Cofactor matrix Q _{xx} :	0.00010078	0.00001152	-0.00006085
		0.00005646	-0.00001050
			0.00042306
Baseline vector:	dX: -0.7626 m	dY: -4.7883 m	dZ: 0.5116 m
	Slope Dist: 4.8755 m	dHgt: -0.6736 m	

For each point the report will display the final coordinates computed for the rover.

If the report has been **configured** to display all possible sub-sections it presents you additionally with:

- Antenna height of the rover
- Solution Type: Solution Type (either phase or code), used Frequency and ambiguity status (yes or no) for the selected baseline
- Time Information (only available for manually occupied points): Time span and duration of the static point
- Quality Information: Standard deviations for the computed baseline vector and position quality of the final coordinates
- Variance-covariance matrix: M₀ and Cofactor Matrix Q_{xx}
- Vector Information: Coordinate differences and slope distance of the baseline vector

Warning messages

This section presents you with all the various warning and error messages that may have been encountered during the processing run. Critical error messages may additionally be displayed in one of the other sub-sections of the report.

Note: Error or warning messages which result in a change of the selected processing parameters will additionally be displayed in the **Comment** column of the **Processing Parameters** section of the report.

GPS Processing Report: SPP

To get an overview on the processing results for each SPP calculation you may invoke the **Results -SPP** Report.

- In the **Results** Tree View click open the  **Report** folder. Click on the  **Point** for which you want to inspect the report. In the right-hand pane of the **Results View** the corresponding **Results - SPP** report opens as an embedded report.

Embedded reports can be saved as HTML files, printed or opened in a stand-alone window:

- To save a report as an HTML file right-click inside the report and select **Save As...**
- To print a report right-click inside the report and select **Print**. A **Print Preview** is also available from the context menu.
- To open the GPS Results Summary Report in a stand-alone window right-click inside the re-port and select **Open Report**. The report will then be listed in the **Open Documents list bar**.
- To select the contents and the layout of the report refer to: [Configure a Report](#)

When the report has been configured to display all possible sections it presents you with the following bits of information:

- [Project Information](#)
- [Point Information](#)
- [Processing Parameters](#)
- [Satellite selection](#)
- [Computed Iono Model](#)
- [Antenna Information](#)
- [Observation statistics](#)
- [Final Coordinates](#)
- [Warning messages](#)

Project Information

[Example:](#)

Project Information

Project name:	PP Sample
Date created:	12/17/2002 14:29:36
Time zone:	1h 00'
Coordinate System name:	WGS 1984
Application software:	Leica SKI-Pro 3.0
Processing kernel:	PSI-Pro 1.0
Processed:	02/07/2003 20:02:59

This section gives you general information on the [Project Properties](#), like the project name, creation date and time, the time zone and the attached coordinate system. You also find information on the software and the processing kernel version as well as date and time of the processing run.

If information has been entered in the [Dictionary](#) page of the Project Properties dialog these pieces of information will be added to this section of the report.

Point Information

Example:

Point Information

B215

Receiver type / S/N: SR530 / 321

Antenna type / S/N: AT502 Tripod / -

Antenna height: 1.3970 m

Initial coordinates:

Latitude: 47° 23' 45.67424" N

Longitude: 9° 38' 10.54053" E

Ellip. Hgt.: 452.7013 m

Time span: 12/21/1998 13:49:45 - 12/21/1998 15:01:30

Duration: 1h 11' 45"

Windows (Exclude):	From	To	Duration
Window 1:	12/21/1998 15:01:32	12/21/1998 15:07:15	5' 42"

This section presents you with the following bits of information on the respective reference and rover points:

- Receiver Information: Type and serial number for the receiver of the selected SPP point
- Initial coordinates for the SPP calculation

If the report has been [configured](#) to display all possible sub-sections of the Point Information it presents you additionally with:

- Antenna Information: Type, serial number and antenna height of the calculated SPP point
- Time Information: Time span and duration of the processed interval

Processing Parameters

Example:

Processing Parameters

Parameters	Selected	Used	Comment
Cut-off angle:	15°	15°	
Ephemeris type:	Precise	Broadcast	No precise ephemeris available, switched to broadcast ephemeris.
Solution type:	Automatic	Code	
Frequency:	Automatic	IonoFree (L3)	
Sampling rate:	Use all	15	
Tropospheric model:	Hopfield	Hopfield	
Ionospheric model:	Automatic	None	

The processing parameters which have been **selected** for the processing run in the GPS-Processing Parameters pages **General** and **Strategy** are listed. Additionally, the parameters which have actually been **used** by the processing kernel are displayed. If the processing kernel changed the selected parameters, a **comment** is given to indicate the reason. Note that only the parameters relevant for SPP calculations are listed.

Satellite selection

[Example:](#)

Satellite Selection

Manually disabled satellites: SV 21

Satellite Windows (Exclude):

Satellite	From	To	Duration
SV 02	12/21/1998 14:09:01	12/21/1998 14:11:30	2' 29"
SV 26	12/21/1998 14:10:10	12/21/1998 14:11:30	1' 20"

This section lists all satellites which have been manually disabled for the processing run. G denotes GPS satellites, R denotes GLONASS satellites and E denotes Galileo satellites. If **satellite windows** have been set this section lists all satellite windows excluded from the computation.

Computed Iono Model

[Example:](#)

Antenna Information

Antenna type: AT502 Tripod
 Horizontal offset: 0.0000 m
 Vertical offset: 0.3600 m
 Additional corrections: Elevation and azimuth

Phase center offsets	L1	L2
Vertical:	0.0683 m	0.0712 m
East:	0.0000 m	0.0000 m
North:	0.0000 m	0.0000 m

Additional corrections:

A \ Z	0°	5°	10°	15°	20°	25°	30°	35°	40°	45°	50°	55°	60°	65°	70°	75°	80°	85°	90°
0° L1	-2.7	-2.7	-2.5	-1.6	-0.5	0.0	0.1	0.6	1.4	1.8	1.4	1.1	1.2	0.9	-1.0	-3.8	-5.6	-5.9	-5.7
0° L2	-1.4	-1.0	-0.6	-0.7	-1.1	-1.0	-0.1	0.8	1.5	2.2	3.0	3.1	2.3	0.8	-1.3	-5.1	-11.2	-17.6	-20.4

This section presents you with the following bits of information for the antennas used on the SPP point:

- Antenna type
- Horizontal and Vertical offset
- Additional corrections: None or elevation and azimuth or spherical harmonics
- Phase center offsets for L1 and L2 in East, North and Vertical

The report can be **configured** to additionally display:

- Additional corrections: The **additional corrections** as defined with the selected antenna are given for L1 and L2 at the various vertical angles.

Observation statistics

[Example:](#)

Observation Statistics

Number of common epochs:	483
Number of used observations (L1):	2337
Number of rejected observations (L1):	0
Number of used observations (L2):	2337
Number of rejected observations (L2):	0

Tracking Status L1:

Satellite		From	To	Status
SV 05	✓	01/12/2005 11:00:00	01/12/2005 11:37:15	Tracked / Used
	✗	01/12/2005 11:37:15	01/12/2005 13:00:30	No data
SV 15	✗	01/12/2005 11:00:00	01/12/2005 12:51:00	No data
	✓	01/12/2005 12:51:00	01/12/2005 13:00:30	Tracked / Used
SV 16	✗	01/12/2005 11:00:00	01/12/2005 11:20:30	No data
	✓	01/12/2005 11:20:30	01/12/2005 13:00:30	Tracked / Used
SV 17	✓	01/12/2005 11:00:00	01/12/2005 12:57:15	Tracked / Used
	✗	01/12/2005 12:57:15	01/12/2005 13:00:30	No data

For each GNSS system used this section gives you a statistical overview on

- the number of processed epochs
- the total number of used observations
- the total number of rejected observations

The report can be **configured** to additionally display the:

- Tracking Status: The status whether a satellite has been **tracked** and **used** ✓ or whether it has been **tracked** but **rejected** ✗ or whether it has **no data** ✗ and the corresponding time span are given for each satellite on L1 and L2. G denotes GPS satellites, R denotes GLONASS satellites and E denotes Galileo satellites.
- Tracking Status (Graphics): For all satellites the Tracking Status on L1, L2 and L5 (if used) is displayed in a graphical summary.

[Example:](#)

Tracking Summary:

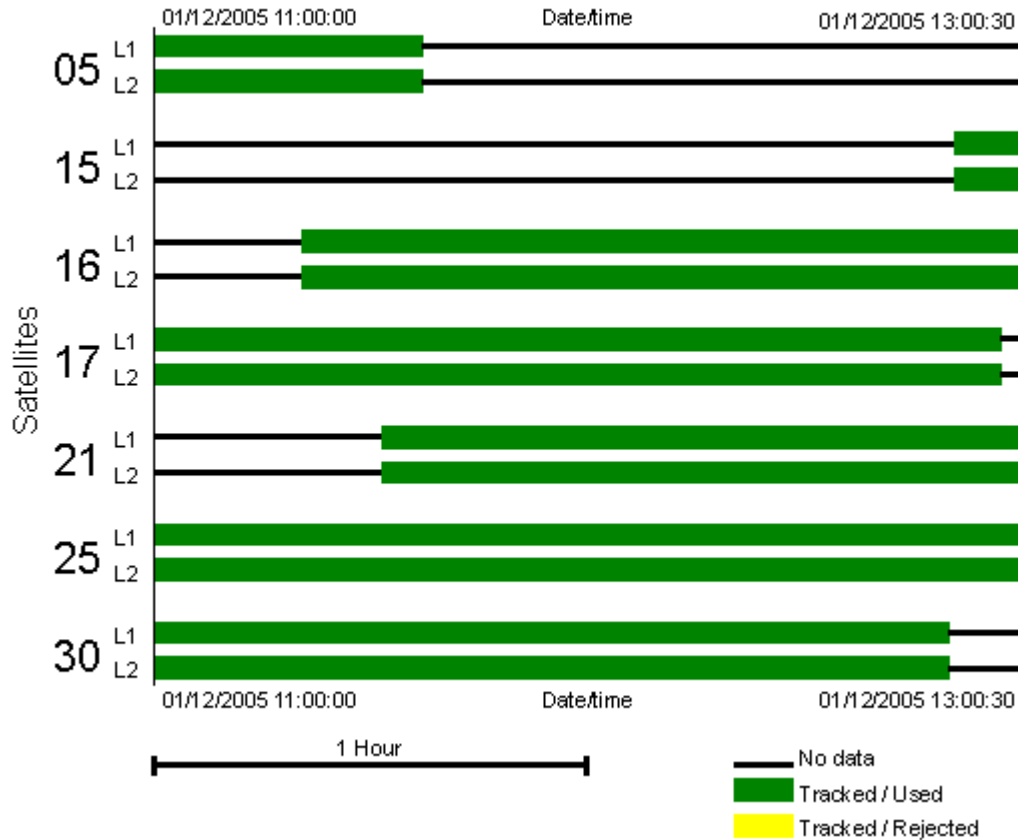

- Right-click into the graphics to get access to functionality like **Zoom In/ Zoom Out**, **Copy** the graphics or **Save** the graphics **as....**

To zoom in to the graphics may be especially useful for detailed inspection of long observation intervals. To zoom back to the original size select **Original View** from the context menu.

Note: If the elevation of a processed satellite drops below the cut-off angle defined in the GPS-Processing Parameters: [General](#) page or if a [satellite window](#) has been set, then these epochs will also be marked as **no data** **X**.

If GLONASS ambiguities were not resolved but kept at their float values then these epochs will be marked as **tracked** but **rejected** **X**.

Final Coordinates

[Example:](#)

Final Coordinates

B215

Coordinates:			
Latitude:	47° 23' 45.55604" N		
Longitude:	9° 38' 10.66482" E		
Ellip. Hgt.:	461.0730 m		
Solution type:	Code		
Frequency:	IonFree (L3)		
Quality:	Sd. Lat: 1.3446 m	Sd. Lon: 0.9534 m	Sd. Hgt: 2.6099 m
	Posn. Qlty: 1.6483 m		
M0:	0.3824 m		
Cofactor Matrix Q _{xx} :	12.36507064	-1.15732936	0.64658965
		6.21683810	-3.09980404
			46.58775154
DOPs (min-max):	GDOP: 2.1 - 3.8		
	PDOP: 1.8 - 3.2	HDOP: 1.1 - 1.4	VDOP: 1.5 - 2.8
Number of used satellites:	GPS: 9		
	GLONASS: -		

This section presents you with the final SPP coordinates computed.

If the report has been **configured** to display all possible sub-sections of the Final Coordinates section it presents you additionally with:

- Solution Type: Solution Type (will be Code for SPP) and Frequency used for the computation
- Quality Information: Standard deviations and position quality for the computed SPP coordinates
- Variance-covariance matrix: M₀ and Cofactor Matrix Q_{xx}
- DOPs: Minimum and maximum values for GDOP, PDOP, HDOP and VDOP
- Number of used Satellites (GPS/ GLONASS/ Galileo)

Warning messages

This section presents you with all the various warning and error messages that may have been encountered during the processing run. Critical error messages may additionally be displayed in one of the other sub-sections of the report.

Note: Error or warning messages which result in a change of the selected processing parameters will additionally be displayed in the **Comment** column of the **Processing Parameters** section of the report.

GPS-Processing Analysis Tool



The Analysis Tool allows you to display graphically:

- Elevation and Azimuth for the observed satellites
- DOP values for the processed time interval
- Residuals of the calculation.

Note:

- To display the above mentioned parameters is only possible if they have been selected for output in the [GPS-processing Parameters: Extended Output](#) page before the processing run has been started.

To start the GPS-processing Analysis tool:

- In the Results View right click on an individual baseline or point in the  **Baselines** or  **Points** tree-view or in the corresponding report-view and select **Analyse** from the context menu.

The Analysis Tool opens in a separate window. Several Analysis windows can be opened and displayed at the same time and will then be listed in the **Open Reports** [list bar](#).

Each Analysis window consists of two left-hand panes:

- a **Chart content** pane and
- a **Legend** for satellites/ DOP types

and a right-hand pane in which the **chart** itself is displayed.

In the **Chart content** pane select which kind of information shall be displayed. This can be either:

- Residuals or
- DOP values or
- Elevation or
- Azimuth.

For the processing residuals you can further select the **Type of Differences** (Single, Double or Triple) and the **Frequency** to be displayed as well as whether **code** or **phase** residuals shall be outlined.

Residuals - Type:

- Select the **Type** of differences on which the displayed residuals shall be based.

Single differences are the differences of the original observations between reference and rover.

Double differences are the differences between single differences for a particular pair of satellites. For calculating the double differences one satellite is always selected as the reference satellite and the other differences are calculated with respect to that satellite. To change the reference satellite right-click on the satellite in the **Legend** and **Select as reference SV**.

Triple differences are the differences between two double differences of two consecutive epochs. For triple differences the reference satellite can also be selected manually.

Residuals - Frequency:

- From the **Chart content** select to display either **Code** or **Phase** residuals. For both either L1 or L2 or the ionospheric free L3 linear combination or the geometry free L4 linear combination can be calculated.

If the data contains the L5 frequency, the L5 code and phase residuals can be displayed as well.

The L3 is a linear combination that practically eliminates the ionospheric path delay. The L4 linear combination is independent of receiver clocks and geometry. It contains the ionospheric delay and may be used to evaluate the ionospheric activity.

Note: Dual-frequency data must be processed to allow for the computation of L3 and L4 residuals.

When analysing an **SPP** result the residuals will always be at single difference level and only code residuals will be available.

Legend:

- In the Legend select which satellites shall be displayed in the chart. G denotes GPS satellites and R denotes GLONASS satellites. For each residual type as well as for elevation or azimuth single satellites can be switched on or off.
- For DOP value charts select which type of DOP values (GDOP, PDOP, HDOP, VDOP) shall be displayed in the chart.
- For Residuals and DOP values the Legend lists the Mean value, the Maximum and Minimum value and the Standard deviation (only for residuals) in a [Report View](#).

Tip:

- Use the Zoom functionality  Zoom in  Zoom out  Zoom 100% in the toolbar to display the chart in more detail.

Related topics:

[Copy a chart to the clipboard](#)

[Save a chart to a file](#)

[Print a chart](#)

Store the GPS-Processing Results

This function enables you to store the processed baseline to the database for further use.

1. In the Tree-View click on **Baselines** or **Points** to list all processed baselines or points in the Report-View.
2. Normally baselines for which the ambiguity have been resolved (Ambiguity Status = Yes) are selected automatically. Otherwise select the baselines as follows:
 - Select them manually or
 - Press **Select** from the Context-Menu (right-click) and choose **All** to select all baselines or choose **Using Criteria**. See [Selection Criteria](#) for more details.
3. From the Context-Menu (right-click) select **Store**.

Note:

- [Hidden Points](#) will be re-calculated automatically when storing the data-processing results.

Level Results

Level-Processing Results: Points

The following items are listed in the Report-View upon selecting **Points** from the Tree-View in the **Results** tab:

Point Id

Point Identification.

Stored Status

Indicates whether the Point has been stored to the data base.

See also: [Store the Level-Processing Results](#)

Ortho. Hgt.

Processed orthometric height.

Delta Hgt.

Processed height difference.

Sd Height

Standard deviation of the processed height.

Hgt. Qlty

Height Quality.

M0, Q11-Q33

Elements of Qxx-matrix.

Level-processing Parameters

Select the computation parameters before you start your computation. The parameters can be changed individually, but system default settings are also available for all parameters.

After the computation has been performed the Level-processing Parameter settings used for the particular computation run are listed in the **Results Management** and may also be output via the [Summary Report](#).

[How to modify Level-processing Parameters](#)

The Level-processing Parameters Property-Sheet consists of the following pages:

[Level Line](#)



[Observations](#)

[Point Heights](#)

[Staff Corrections](#)

Level Processing Report: Summary

When a processing run is complete, a summary report of the results is generated. To get an overview on the processing results for each processing run you may invoke the **Processing Summary Report**.

- In the **Results** Tree View open the node  of the current processing run and click on  **Summary**. In the right-hand pane of the **Results View** the Level Processing Summary report opens as an embedded report.

Embedded reports can be saved as HTML files, printed or opened in a stand-alone window:

- To save a report as an HTML file right-click inside the report and select **Save As...**
- To print a report right-click inside the report and select **Print**. A **Print Preview** is also available from the context menu.
- To open the Level Summary report in a stand-alone window right-click inside the report and select **Open Report**. The report will then be listed in the **Open Documents** list bar.
- To select the contents and the layout of the report refer to: [Configure a Report](#)

When the report has been configured to display all possible sections it presents you with the following bits of information:

- [Project Information](#)
- [Line Properties](#)
- [Processing Parameters](#)
- [Points](#)
- [Warning Messages](#)

Project Information

[Example:](#)

Project Information

Project name:	Level Sample
Date created:	09/12/2003 11:02:51
Manager:	Mr. Johnson
Client:	Little Hut Company
Street:	Woods Lane
Map reference:	D60-C61
Application software:	LGO 1.0

This section gives you general information on the project to which the line(s) that have been processed in that run belong. Next to the project name you see the properties as entered in the [Dictionary](#) page of the Project Properties dialog.

The following sections of each summary report are **line specific** and will be displayed for each level line that has been processed in the selected run:

- Level Line
- Processing parameters

[Level Line Name]

[Example:](#)

1

Line length: 509.9692 m
 Method: BF
 Start point id: 1
 Number of stations: 12
 Date/time: 12/05/2001 09:03:22
 Number of observations: 24

To learn more about the Line Properties summarized in the Processing Report refer to the definitions given in: [Level-Processing: Lines Report View](#).

Processing Parameters

[Example:](#)

Processing Parameters

Adjustment method: by distance
 Processed with Staff: No
 Corrections:
 Height difference: 0.7980 m

Tolerance	Permitted [m]	Actual [m]	Accepted
Misclosure	0.0056	-0.0021	✓
Height error per station	0.0005	-0.0002	✓
Distance balance	10.0000	1.0260	✓

The parameters listed in the Summary report correspond to the [Level line processing parameters](#).

The Summary report compares the values **permitted** in the level processing parameters to those **actually** computed. If the actual values are smaller than those permitted, the result is **accepted**.

At the end of each report an overview on **all** points, their calculated heights, delta heights, point classes and standard deviations is given. If any warnings have been issued during the processing run or if any errors occurred these are summarized for all lines and points in the **Processing Errors and Warnings** section.

Points

[Example:](#)

Points

Point Id	Epoch	Height [m]	Delta Hgt. [m]	Point Class	Sd. Hgt. [m]
1	12/05/2001 09:03:22	500.0000	-	Control	-
2	12/05/2001 09:09:01	500.0979	0.0979	Measured	0.0007
3	12/05/2001 09:13:22	500.0875	-0.0104	Measured	0.0007
4	12/05/2001 09:19:10	500.1442	0.0566	Measured	0.0007
5	12/05/2001 09:26:51	500.1730	0.0289	Measured	0.0007
6	12/05/2001 09:30:04	500.1605	-0.0125	Measured	0.0007
7	12/05/2001 09:35:36	500.3213	0.1608	Measured	0.0007

Summarized at the end of the report you see a listing of all points that have been processed and their final adjusted heights together with some of the essential [point properties](#) like the *point class* and *height quality* of each point.

Processing Errors and Warnings

[Example:](#)

Processing Errors and Warnings



Level Line '1', Point '1': Maximum difference from fixed height exceeded.



Level Line '1', Point '13': Maximum difference from fixed height exceeded.

The **Warnings** section lists instances that might influence the processing results in a negative way. Note that the level line can always be processed and results achieved despite of such warning messages. However, it is recommended to inspect the results carefully.

If a line could not be processed, the reasons are listed in the **Errors** section of the Summary Report. Errors prevent a processing run from being completed due to one or more of the following reasons:



Invalid backsight to Pt: X (Station No: Y):

The backsight Point Id is not the same as the previous foresight Point Id.



Invalid second backsight to Pt: X (Station No: Y)

In a BFFB or aBFFB level line the second backsight has a different Point Id to the first backsight.



Invalid second foresight to Pt: X (Station No: Y)

In a BFFB or aBFFB level line the second foresight has a different Point Id to the first foresight.



Missing Backsight at Station X (Station No: Y)

You have modified a file so that a station contains a foresight observation but not a backsight observation.



Missing Foresight at Station X (Station No: Y)

You have modified a file so that a station contains a backsight observation but not a foresight observation.



Missing Control cannot process level line (Station No: Y)

You have attempted to process a level line that does not have a Control point.

Tip:

- If error messages are issued for a particular level line it is recommended to go back to the Level processing booking sheet and inspect the level line. Check, that the line is not broken due to **de-activated measurements** or wrong point identifications and/or check that at least one **Control point** exists in the level line.

Store the Level-Processing Results

This function enables you to store the processed level lines to the database for further use.

1. In the Tree-View click on **Points** to list all processed points of the level line in the Report-View.
2. Select the points you want to store as follows:
 - Select them manually or
 - Press **Select** from the Context-Menu (right-click) and choose **All** to select all points. Choose **None** to de-select all points.
3. From the Context-Menu (right-click) select **Store**.

Note:

- When storing processed results the subclass of the stored points will be **Processed**.

Codelists

Codelist View

The Codelist View of a Project lists all the Codes that have been used in the field. Upon importing raw data the used Codes are automatically transferred to the Project database and can be modified in this View.

- The Codelist View may be accessed via the  **Codelist** Tab from within a project window.

Note:

- See [Point Properties: Thematical Data](#) on how to change the Thematical Codes of individual Points of a Project database.

Select from the list below to learn more about the Codelist View:

[Print a Codelist](#)

[Codelist Properties](#)

[Codelist Structure](#)

[Code Group](#)

[Code](#)





[Attributes](#)

Codelist Management

The Codelist Management enables you to create Codelists that will work with Leica Instruments.

A Codelist contains coding information that may be used to describe topographical features and points during measurement in the field.

If you import raw data with a Codelist attached into LGO, the Codelist will be stored within a Project and is accessible via the Codelist View.

A  Codelist may contain  **Thematical codes** and / or  **Free codes**. A *SmartWorx* advanced codelist may also contain  **Line** and  **Area codes**.

A Codelist consists of three building blocks within its structure:

Code Groups:

The primary building block of a Codelist is known as **Code Groups**. One or more Code Groups may be contained within a Codelist. A Code Group will usually describe a large group of objects such as *Buildings*, *Vegetation* etc.

Codes:

Codes are the secondary building block of a Codelist and may be definite features. For example, a Code Group called *Vegetation* could have the codes *Tree*, *Shrub* and *Hedge*. Alternatively, the Codes could consist of numbers only with a Code Name describing the code. E.g. code 145 could relate to the code name *Tree*.

Attributes:

Each Code may have one or more **Attributes** attached to it. Attributes are the tertiary building block of a Codelist. Attributes prompt the user to enter information describing a Code.

For example, the code *Tree* could have the attributes *Diameter*, *Species*, *Height*, and *Remark* attached to it. You may then define an Attribute Value for an Attribute. It may be chosen from a predefined **Choice List** or a predefined **Range**. For example, possible Values for the Attribute *Diameter* could be from a **Range** from 1 to 25 (meters) and the Attribute *Species* from a **Choice List** that contains the Values *Pine*, *Fir*, and *Oak*.

Note that you do not have to define an Attribute Value within Codelist Management. If no value is defined for an Attribute you may enter a value or description in the field.

A Codelist can be uploaded to a Sensor or downloaded from a Sensor using the **DXM** (Data Exchange Management) tool.

Select from the list below to learn more about Codelist Management:

[Create a New Codelist](#)

[Delete a Codelist](#)

[Print a Codelist](#)

[Register](#)

[Send To](#)

[Codelist Properties](#)

[Codelist Structure](#)

[Code Group](#)

[Code](#)

Attributes

Images

Images

The **Images** view enables you to view and manage all images either imported manually or from one or more SmartWorx jobs into an LGO project.

- The **Images** View may be accessed via the  **Images** Tab from within a project window.

The view consists of two left-hand panes and a right-hand pane.

[Example:](#)

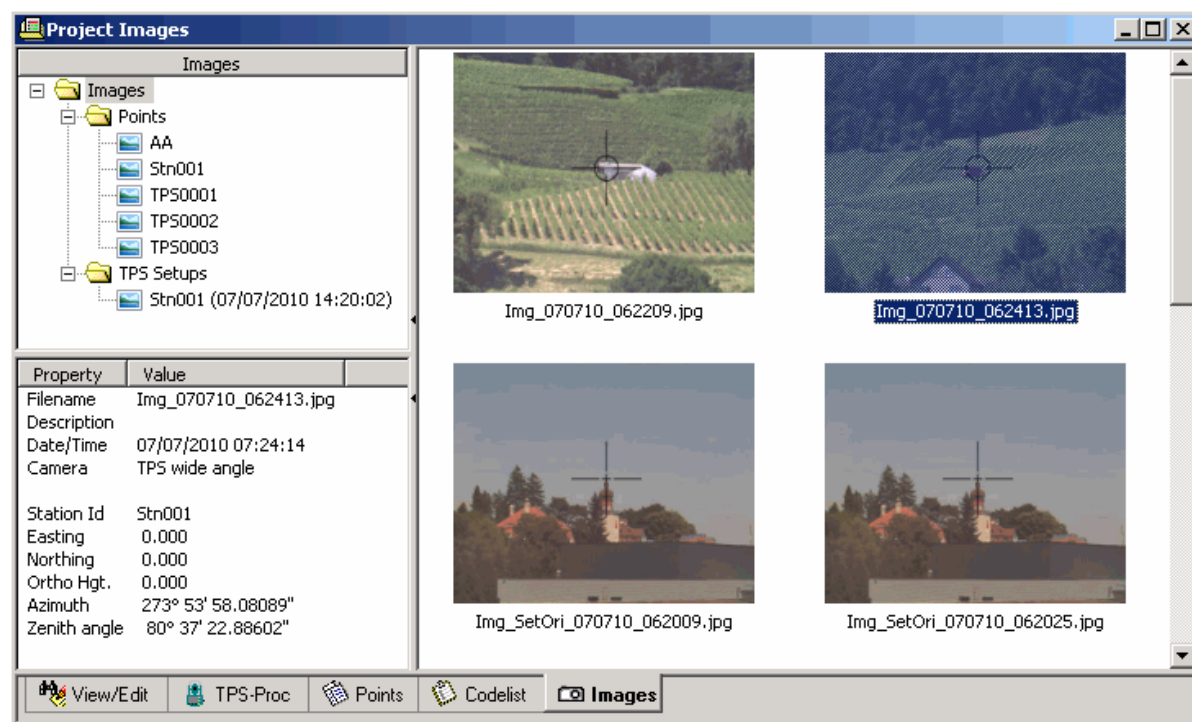



In the top left pane of the **Images** view are the object nodes for:

 **Images:** Click onto the top node to see all images that exist within the project in the right-hand side thumbnail view.

 **Points:**
Click onto the Points node to see all images linked to points.

In the Points node the images are grouped by the points they are assigned to. Click onto a  **Point** to see all images assigned to it.

 **Lines/ Areas:**
Click onto the Lines/ Areas node to see all images linked with line or area objects.

In the Lines/ Areas node the images are grouped by the lines/ areas they are assigned to. Click onto a  **Line/ Area** to see all images assigned to it.

 **TPS setups:**
Click onto the TPS setups node to see all images that were stored during a TPS job.

In the TPS setups node the images are grouped by the station they were stored from. Click onto a  **TPS setup** to see all images stored with it.

 **Not Linked:** Click onto the Not Linked node to see all images that are not linked to any object in the right-hand side thumbnail view.

If you select one of the images displayed in the right-hand side **Thumbnail** view then the lower left-hand **Properties** pane displays the image properties:

Filename, Description, Date/Time:

The name of the image file is given together with the date and time when the picture has been taken. If a description has been added in the field it will be displayed here as well.

Camera:

The type of camera is listed. Available are the types **TPS wide angle** and **CS controller**.

Station Id:

The Id of the TPS station on which the picture has been taken is given.

Easting/ Northing/ Ortho. Height:

The local grid coordinates of the TPS station on which the picture has been taken are given.

Azimuth/ Zenith Angle:

The alignment which the telescope had when the picture was taken is given as azimuth and zenith angle in the local grid coordinate system.

Note:

- For unlinked images there will **not** be any information on the **Station Id**, the local grid coordinates of the station and the alignment of the telescope. Only the filename, the file description, date and time and the camera information will be given.

In the Thumbnail view you can:

- Double-click onto an image or select an image and press *Enter* to open the **Detail view**. Press the *Esc* key to close the Detail view and return to the Thumbnail view.
- Adjust the size of the thumbnails with the mouse wheel or by selecting *Num Lock* on the keyboard and pressing the *+ / -* keys. To reset the thumbnail size to the default press the (*Alt +*) *Home* key.
- **Import Images** manually. Manually imported images will be shown in the thumbnail views for the **Images** top node and the **Not linked** node.
- Open an image in the viewer that you have set to be your Windows default viewer by selecting **Open...** from the context menu. If your Windows default viewer allows editing of pictures then you may change the image according to the functionality which the viewer offers to you. Save the image in the Windows viewer to take over your changes to the original image. To see the changes in the **Imaging** component select **Refresh thumbnails** from the context menu in the **Thumbnail** view.
- Go to the directory in which the original images are stored by selecting **Open containing folder...** from the context menu. The Windows Explorer opens and goes directly to the image folder. Windows Explorer will be available to you to deal with the original images. Select **Open with** if you want to open an image in a viewer different to the Windows default viewer.
- **Delete** the selected image(s) from your PC.
- **Unlink** image(s) from the objects (a point or a line/ area or a TPS setup) they are currently linked to. This functionality is only available if you are in the thumbnail view for a specific point or line or area or TPS setup. When an image is unlinked from **all** objects it has been linked to it will move to be listed under the

Not Linked node. If an image is unlinked from a TPS Setup it can only be linked to points, lines or areas again but not to a TPS setup.

- **Link** images to an object (a point or a line/ area). It is not possible to link images manually to TPS setups.
- Refresh all thumbnails by pressing F5 or selecting **Refresh thumbnails** from the context menu. All images will be verified and if any changes have been made to the originals then the thumbnails will be updated.

In the Detail view you can:

- **Zoom** in and out of the image, switch **Panning** on or off and **blend** the selected image according to your needs.

Import Images

Images can also be imported manually.

To import images manually:

1. In the project to which the images shall be imported open the  **Images** view and select **Import Images...** either from the **Thumbnail view** on the right or from the **Images** main menu.
2. In the **Import Images** dialog browse to the location where the images to be imported are stored.
3. Select the images you want to import and select **Import**.

If you want to see thumbnails for each image click onto the  **View Menu** button in the **Import images** dialog and select **Thumbnails** from the popup menu. The representation will change to thumbnails being shown together with the file names.

The selected images will be inserted into the **Images** view under the  **Images** top node in the tree view and indicated as thumbnails in the corresponding **Thumbnail view** on the right. Once inserted successfully the manually imported images are available for being linked to points, lines or areas.

Link or unlink Images

All images which are available in the **Images** view may be manually **linked** to **points**, **lines** or **areas** within the same LGO project.

To link one or more images from within the Images view:

1. Click onto the  **Images** top node in the tree view to see the complete collection of all available images in the corresponding thumbnail view on the right.

Alternatively, click onto the  **Not linked** node to see only those images in the thumbnail view which are not yet linked.

2. Select the images to be linked in the thumbnail view and choose **Link** either from the context menu or from the **Images** main menu.
If you know that an image is linked already to a specific point, line or area you may also open the thumbnail view for that point, line or area and select the image to be linked again from there.
3. In the **Link Image** dialog select the **Point** or the **Line** or the **Area** to which the selected image(s) shall be linked.
4. Leave the dialog with **OK**.

To link one or more images from within View/ Edit:

1. Right-click onto a point or a line or an area and select **Link image to point/ line/ area ...** from the context menu.
2. In the **Link Image** dialog all images that are available with the current project will be shown to you in a thumbnail view together with the image name.

If you want to be offered for selection just the still unlinked images check the option **Show unlinked images only**.



3. Select the images to be linked with the selected point / line/ area from the thumbnail view.
4. Leave the dialog with **OK**.

The selected image(s) will be linked to the point or line or area as specified in the **Link Image** dialog.

In the  **Images** view a node for  **Points** or  **Lines/ Areas** will be added to the tree view if it is not available yet. If a specific point or line or area does not have images linked before it will be added under its node and in the corresponding thumbnail view the newly linked images will be shown. If a specific point or line or area does already have linked images the newly linked images will be added to the thumbnail view.

In  **View/ Edit** the point symbol changes to indicate that images are linked. If all images that have been linked to a point are unlinked again the point symbol changes back to indicate the current point class.

To unlink one or more images from within the Images view:





1. Open the node for  **Points** or  **Lines/ Areas** and select a specific point or line or area from which one or more images shall be unlinked.
2. In the thumbnail view for the selected object select the image(s) to be unlinked and choose **Unlink** from the context menu.

3. Confirm the warning message that is issued with **Yes** to unlink the selected images.

To unlink one or more images from within View/ Edit:

1. Right-click onto a point or a line or an area to which images are linked and select **Properties...** from the context menu.
2. In the **Properties** dialog go to the **Images** tab and select the images to be unlinked from the selected object in the thumbnail view.
3. Right-click into the selection and choose **Unlink** from the context menu.
4. Confirm the warning message that is issued with **Yes** to unlink the selected images.

Note:

- In the  **Images** view the **Unlink** functionality is only available for specific objects. You cannot unlink images from within the thumbnail view for the  **Images** top node.
- If an image is linked to more than one object it is only moved to the  **Not linked** node in the  **Images** view when it is unlinked from **all** objects.

Import

Import

This component is used to import data into the Office database. Data such as GPS, TPS or Level raw data (measurements), coordinate files in ASCII format or precise ephemeris may be imported.

Select from the list below to learn more about Import:

[Raw Data...](#)

[ASCII Import...](#)

[Precise Ephemeris...](#)

Raw Data

Raw Data Import

This component allows you to import GPS, TPS or Level measurements (raw data) into a project. GPS raw data may be either static observations for post-processing or Real-Time data. Data may be read in from:

- local memory devices
- backup files on disk

The following formats are supported for GPS:

- Leica SmartWorx, points and raw data
- Leica GPS System 500/SR20, points and raw data.
- Leica GPS System 300, points and raw data.
- LandXML
- RINEX observations and/ or broadcast orbit files. To import RINEX observations the **RINEX Import option** has to be included in your [licence](#).
- Points only: database points without raw data from either SmartWorx instruments (DBX) or from GPS500 instruments (GeoDB).
- TDS (GPS observations or GPS points only)

The following formats are supported for TPS:

- SmartWorx, points and raw data.
- LandXML
- GSI (Points and TPS observations)
- Points only: SmartWorx database points without raw data (DBX)
- TDS (TPS observations or TPS points only)

The following formats are supported for Levels:

- DNA 03/10 raw data
- GSI (Level observations)

With GSI Import note:

- To successfully import GSI observations, the GSI data in the file must be recorded using the [Standard GSI Word Indexes](#) and approximate co-ordinates must be available for all points. In addition, as the Adjustment Kernel is based on a full 3D model, the true slope distance is required, without any geometrical reductions.

With LandXML Import note:

- If the LandXML file to be imported contains points with WGS 84 geodetic coordinates **and** local grid coordinates then the local grid coordinates will be imported into the project. If GPS setup information is available, then the points will be stored with WGS 84 geodetic coordinates.

To learn more about Raw Data Import see:

[How to Import GPS Raw Data](#)

[How to Import TPS Raw Data](#)

[How to Import Level Raw Data](#)

[How to import TDS Raw Data](#)

Standard GSI Word Indexes

The following Word Indexes are recognised for TPS observations during import:

Word Index	Contents
11	Point ID
21	Horizontal direction
22	Vertical angle
31	Slope distance
51	ppm + mm distance corrections
71	Thematical code
72-79	Attribute information
81	Target Easting
82	Target Northing
83	Target Elevation
84	Station Easting
85	Station Northing
86	Station Elevation
87	Target Height
88	Instrument Height

Note:

Word Indexes 41 can additionally be treated as operation codes. For details refer to: [GSI Operation Codes](#).

For Word Indexes 71-79 (Code and Attributes) leading zeros will be truncated.

In order to successfully import TPS observations all setup data and associated observation data including approximate co-ordinates is required as follows:

Setup Data:

- Setup Point Id
- Instrument Height
- Station Easting
- Station Northing

- Station Elevation (Orthometric Height)

Observation Data:

- Target Point Id
- Target Height
- Target Easting
- Target Northing
- Target Elevation (Orthometric Height)

Plus, one or more of the following measurements:

- Direction
- Slope distance + (optional ppm correction)
- Vertical angle

Notes about measurements:

- If the slope distance is zero, the measurement is automatically deselected
- If the slope distance is zero and the vertical angle is 90 deg / 100 gons, the vertical angle is automatically deselected.
- If the ppm correction is included, the slope distance is treated as being geometrically reduced for projection and height and therefore, the ppm is re-applied to the distance to obtain the non-reduced slope distance before the data enters the database.



How to Import GPS Raw Data



1. From the **Import** menu select **Raw Data...** or press  (Import Raw Data) in the **Tools** List Bar.
2. Select the type of data to be imported from the list (**Files of type**):
 - SmartWorx raw data
 - Land XML
 - GPS 500/SR20 raw data
 - GPS 300 raw data
 - RINEX files*
 - Database points (DBX, GeoDB)**
3. From the file browser **select a job or file**.
Check **Include subfolders** and select a directory if you wish to import automatically the data of all sub-directories contained in this directory.

Note: If you intend to import **directly from a local memory device**, the jobs to be imported are stored:
 - in the \DBX directory for SmartWorx.
 - in the \GeoDB directory for GPS500.
4. Select **Import** to proceed with the **Assign** dialog or select **Cancel** to abort the function.

In the **Assign** dialog:

5. Select the **GPS** tab if you want to pre-view or modify the raw data.
6. If you import Real-Time data, press the  **Fieldbook** button in the bottom left corner of the dialog to generate a **Fieldbook Report** on the job(s) to be imported***.
7. In case you are importing GPS 500 or SmartWorx data directly from a local memory device, press the  **Backup** button in the bottom left corner of the dialog to save the raw data to the harddisk***. Select a directory from the browser and press OK to confirm.
8. Select the **Settings** tab if you want to modify the **Assign** Settings. Which subset of settings is available in the **Settings** tab depends on the type of data to be imported.
9. In the **General** tab select an existing **Project** from the list.

Alternatively: Create a new Project via the context-menu (right-click) **New...**
10. Press the **Assign** button to import the data into the selected Project or **Close** to abort the function.

Note: The Assign button will be active if a project is selected. The name of the selected project is displayed in the title-bar of the property sheet.

Tip /Note:

- * If a navigation file is selected for import and its associated observation file exists, the observation data is also imported, otherwise only the broadcast ephemeris are imported.
- ** Use the file type **Database points** to import points from SmartWorx or System 500 databases. Observations are ignored. This type is also required to import jobs that have been transferred to the sensor using the Data Exchange Manager.
- *** Modifications of the data in the **GPS** page are taken over into the Fieldbook. For GPS500 the modifications are also taken over into the Backup. For SmartWorx raw data only modifications of antenna height readings of static intervals are taken over into the Backup.



- The Assign dialog has the same functionality as the [Project Management](#). E.g. Select **New** from the context-menu (right-click) if you want to create a new Project during the import procedure.

How to Import TPS Raw Data



1. From the **Import** menu select **Raw Data...** or press  (Import Raw Data) in the **Tools** List Bar.
2. Select the type of data to be imported from the list (**Files of type**):
 - SmartWorx
 - LandXML
 - GSI (Observations)
 - GSI (Points only)
 - Database points (DBX, GeoDB)
3. From the file browser **select a job** or **file**.
Check **Include subfolders** and select a directory if you wish to import automatically the data of all sub-directories contained in this directory.
4. When importing GSI data click the **Settings** button to define additional Import settings as to how the TPS raw data shall be imported to a project.
5. For GSI files the point class is not pre-defined. Thus, select the **Default point class**. Choose between **Control** and **Estimated**. The Default point class will only be applied to points without class information (GSI).
6. Select **Import** to proceed with the **Assign** dialog or select **Cancel** to abort the function.

In the **Assign** dialog:

1. Select the **TPS** tab if you want to pre-view or modify the raw data.
2. If you import SmartWorx data, press the  **Fieldbook** button in the bottom left corner of the dialog to generate a **Fieldbook Report** on the job(s) to be imported**.
3. In case you are importing SmartWorx data directly from a local memory device, press the  **Backup** button in the bottom left corner of the dialog to save the raw data to the harddisk. Select a directory from the browser and press OK to confirm.
4. Select the **Settings** tab if you want to modify the **Assign** settings. Which subset of settings is available in the **Settings** tab depends on the type of data to be imported.
5. In the **General** tab select an existing **Project** from the list.
Alternatively: Create a **new Project** via the context-menu (right-click) **New...**
6. Press the **Assign** button to import the data into the selected Project or **Close** to abort the function.

Note:

- To successfully import GSI observations the GSI data in the file must be recorded using the **Standard GSI Word Indexes** and approximate co-ordinates must be available for all points. In addition, as the Adjustment Kernel is based on a full 3D model, the true slope distance is required, without any geometrical reductions.
- Use the file type **Database points** to import points from the SmartWorx database. Observations are ignored. This type is also required to import jobs that have been transferred to the instrument using the Data Exchange Manager.
- Modifications of Survey observations in the **TPS** page are taken over into the Fieldbook. Modifications of **Setup data** are **not** taken over into the Fieldbook.

Tip:

- The Assign dialog has the same functionality as the [Project Management](#). E.g. Select New from the context-menu (right-click) if you want to create a new Project during the import procedure.

How to Import TDS Raw Data



1. From the **Import** menu select **Raw Data...** or press  (Import Raw Data) in the **Tools** List Bar.
2. Select the type of data to be imported from the list (**Files of type**):

TDS (Observations)
TDS (Points)

When selecting TDS (Observations) then GPS baselines and TPS observations contained in the raw data file will be imported.

When selecting TDS (Points) only the rover/ target points without observations will be imported.

3. From the file browser **select a file**.
Check **Include subfolders** and select a directory if you wish to import automatically the data of all sub-directories contained in this directory.
4. Click the **Settings** button to define Import settings as to how the TDS raw data shall be imported to a project.
5. Select **Import** to proceed with the **Assign** dialog or select **Cancel** to abort the function.

In the **Assign** dialog:

6. Select the **View data** tab if you want to pre-view or modify the raw data. Depending on the data **View data** tabs will be available for **GPS** and **TPS** or for **Points**. Rename or exclude points in this tab if required.
7. Select the **Settings** tab if you want to modify the **Assign Settings**.

When importing TDS (Observations) and GPS as well as TPS data are contained in the file, then you can select not to import (de-select) one or the other data type.

When importing TDS (Points) and GPS data is contained in the file, then you can select whether the rover coordinates shall be imported as WGS84 or as Grid coordinates.

8. In the **General** tab select an existing **Project** from the list.

Alternatively: Create a new Project via Context-Menu (right-click) **New...**

9. Press the **Assign** button to import the data into the selected Project or **Close** to abort the function.

Tip /Note:

- To successfully import TDS data the data must be available in the TDS *.raw format. For details on which records of the TDS raw data format are supported see: [TDS raw data format](#).
- The Assign dialog has the same functionality as the **Project Management**. E.g. Select New from the context-menu (right-click) if you want to create a new Project during the import procedure.

TDS raw data format

TDS is the format stored on various data collectors running software of "Tripod Data Systems". LGO supports the following records of the TDS raw data format (extension *.raw):

Job specific records:

JB: Job name, date
MO: Linear and angular units

GPS specific records:

BP: Reference point
EP: Rover point (WGS84)
GS: Rover point (Local Grid)

TPS specific records:

OC: TPS reference point (setup)
SS: TPS measured point (side shot)
TR: TPS measured point (traverse)
LS: Instrument heights (setup, target)
BK: Point Ids (setup, target), orientation

Coding information:

FC: Thematical Code
AT: Attributes

Note:

- When importing **TDS (Observations)** for GPS data the BP and EP records are read. Reference and rover coordinates will be stored in *WGS84* and the baseline vector is available. When importing **TDS (Points only)** you can select to either import the rover coordinates as *WGS84* (EP record) or as *Local* (GS record)
- The coding records (FC and AT) are only imported if the option **Feature Code** was selected in the [Import Settings - Coding](#) page.
- When importing **TDS (Points only)** the record SP (store point) is also imported.

How to Import Level Raw Data



1. From the **Import** menu select **Raw Data...** or press  (Import Raw Data) in the **Tools** List Bar.
2. Select the type of data to be imported from the list (**Files of type**):

DNA 03/10 raw data
GSI (Observations)

3. From the file browser **select a file**.

Check **Include subfolders** and select a directory if you wish to import automatically the data of all sub-directories contained in this directory.

4. Click the **Settings** button to define job specific Import settings as to how the level raw data shall be imported to a project.
5. Select **Import** to proceed with the **Assign** dialog or select **Cancel** to abort the function.

In the **Assign** dialog:

6. Select the **Level** tab if you want to pre-view or modify the raw data. Rename lines or exclude lines in this tab if required.
7. Select the **Settings** tab if you want to modify the Assign Settings. Which subset of settings is available in the **Settings** tab depends on the type of data to be imported.
8. In the **General** tab select an existing **Project** from the list.
Alternatively: Create a new Project via the context-Menu (right-click) **New...**
9. Press the **Assign** button to import the data into the selected Project or **Close** to abort the function.

Tip /Note:

- The Assign dialog has the same functionality as the **Project Management**. E.g. Select New from the context-menu (right-click) if you want to create a new Project during the import procedure.

Merging Reference Coordinates during Import

Reference triplets are created in the project database automatically when importing GPS Real-Time or TPS raw data, when importing GPS baseline vector information from ASCII files or when dragging and dropping observations (GPS or TPS) into the project.

In order to keep networks consistent only one Reference triplet can exist for a point. If there already exists a Reference triplet for a point for which another reference needs to be created during the Import procedure, a check is made whether the Reference triplets can be merged. In the [Tools- Options - General](#) page you can set the maximum difference to be allowed between the Reference triplets for merging. If the difference is bigger than the **Threshold to merge reference triplets** a new point will be created and the Reference triplet will not be merged. Instead a separate Point Id ('Point Id (2)') will be created. You can then always later merge the reference triplets manually using the [Re-assign Reference](#) functionality.

Whereas GPS references (resulting from post-processing or real time measurements) are always stored with *WGS84* coordinates, the Reference triplet of a TPS setup is typically stored with *Local Grid* coordinates. If in a project a point has got both reference types (e.g. when you import TPS data and the TPS station was setup on a point for which there already exists a GPS reference in the project) then a coordinate system must be attached to check whether the reference coordinates can be merged. If you wish to merge the references and the connected observations even if the coordinate system is missing, then you may check the option **Always merge reference triplets...** in the [Tools - Options - General](#) page. This should only be done if possible inconsistencies are solved in a subsequent **Adjustment** run.

See also:

[Re-assign Reference Triplets](#)

[Modifying Reference Coordinates](#)

[Point Classes and Subclasses](#)

Import Settings (TPS/ Level)

Import Settings (TPS/ Level)

In the Import Settings dialog you may define additional settings as to how the TPS or Level raw data shall be imported to a project.

In the **Coding** tab set how the feature codes are to be interpreted.

In the **Standard Deviation** tab set which standard deviations shall be used with the observations.

In the **Centring/ Height** tab set the accuracy for the **TPS** instrument and target setup.

Note:

- The Import Settings are also available when you are import data in TDS format (Observations or Points only). The settings are slightly different to the GSI Import Settings.

Import Settings: Coding

In the **Coding** page of the **Settings** dialog you may decide on how the codes shall be treated during import.

Feature Coding is a time stamp code. Feature Coding may be **interpreted** as either Thematic or Free or may be ignored (**None**). If you choose **None** points are created without codes.

- When you select **Free** the result will be a time stamp code. Time stamp codes are not point related.
- When you select **Thematic** a point related code will be created and you have to decide on which point(s) the code shall be related to.

Thematic codes may belong to either **previous** or **following** points. Decide on whether the Feature Code shall be **applied to**:

- the previous or following point
- all previous or all following points until a different code is encountered while reading the raw data file
- the previous point and all following points until a different code is encountered while reading the raw data file.

Click the **Defaults** button to return to the system defaults.

Note: Codes registered as WI 71 will be imported as thematical codes independent of the Coding import setting.

When you import files of type GSI (TPS observations) and your GSI file contains special operation codes as specified in the LISCAD software, then you may additionally tick the checkbox **Interpret file based upon operation codes**. If you check this option you can select the **linear units**, the **angular units** and the **coordinate order** (Easting, Northing or Northing, Easting) that shall be used for the operation codes. These settings will only be applied for Instrument and Target Heights (operation codes 1 and 2), for Fixed Azimuth Values (operation code 4) and for Fixed Coordinates (operation code 9).

For details see: [GSI Operation Codes](#).

Import Settings for TDS data:

For TDS data you may decide from where in the TDS raw data file the coding information is taken. In the **Interpret feature coding from** edit field select:

- **Feature code** to read the coding information from the 'FC' record of the [TDS raw data file](#). Note that the data collector needs to be configured to write this information to the raw data file.
- **Description** to interpret the 'Description' field as the point code. The 'Description' field is available in various records of the raw data file.

Import Settings: Standard Deviations

In the **Standard Deviation** page of the **Settings** dialog enter the default Absolute and Relative standard deviations to be applied to each TPS observation or the standard deviation for a single Level height reading.

A TPS observation may consist of a **Direction**, a **Distance** and a **Zenith angle** observation. You may enter an absolute and a relative standard deviation for each of the components.

For level observations the standard deviation of a single staff reading may be entered. The standard deviation of the total height difference will be calculated from these values.

Click the **Defaults** button to return to the system defaults.

Apply defaults to:

Decide on whether the settings you made shall be applied to **all observations** or to only those observations which have not got a standard deviation in the GSI file (**observations without sds**). If you choose **all observations** the standard deviations attached to the observations in the GSI file will be ignored and the default settings you made in the office software will be applied.

Import Settings for TDS data:

TDS raw data may contain GPS and TPS data. Therefore, you can select standard deviations for **Directions**, **Distances**, **Zenith angles** and **GPS baselines**.

Import Settings: Centring/ Height

The **Centring / Height** page enables you to define the default accuracy for each TPS Setup or TPS Target to be imported.

The Centring and Height accuracy of the two end points of an observation (Setup and Target) may be defined in addition to the **Standard Deviation** of a measurement.

The **Centring** error defines the predicted error that could have been made when centring the instrument/target over the point. The **Height** error defines the predicted error when measuring the height of the instrument/target above the point.

Click the **Defaults** button to return to the system defaults.

Apply defaults to:

Decide on whether the settings you made shall be applied to **all observations** or **none** of the observations.

Import Settings for TDS data:

TDS raw data may contain GPS and TPS data. The setup and target centering and height errors are applied to both types of observations.

GSI Operation Codes

Special operation codes can be used in order to extend the importing capabilities of the GSI file.

LISCAD has specified a system of codes for Leica instruments to enhance the GSI file. For a full list of the available LISCAD codes please refer to the LISCAD Online Help

When in the **Coding** tab of the **Import Settings** dialog you tick the checkbox **Interpret file based upon operation codes** all the Word Index 41 codes are treated as operation codes. In the Coding tab you also define the **linear unit**, the **angular unit** and the **coordinate order** for the operation codes.

The following operation codes are supported.

Operation Code 1

Operation Code 1 allows for a new setup prior to the next observation.

42. Station Point Identifier

43. Instrument Height

44. Target Height

45. Backsight Point Id (optional)

All observations following this record belong to this setup till the next setup record comes.

[Example:](#)

```
410050+00000001 42....+00000001 43....+00001565 44....+00000145
```

Operation Code 2

Allows for the entry of a new target height. This is done prior to the next observation. All following observations have the target height defined by Operation Code 2.

[Example:](#)

```
410050+00000002 42....+00001200
```

Operation Code 3

Defines sets of directions, including the vertical and horizontal angles and slope distances.

42. Number of Arcs to be read (default is 2 arcs)

43. Number of Foresights (default is 1)

On extracting the sets of directions, the horizontal and vertical angles and the distances are averaged.

[Example:](#)

```
410050+00000003 42....+00000004
```

Operation Code 4

Defines a fixed azimuth, which is used immediately after a new setup (operation code 1)

[Example:](#)

```
410050+00000001 42....+00000001 43....+00001565 44....+00000145 45....+0000STN2  
410051+00000004 42....+00900000
```

This shows the setup operation code (1) together with the operation code (4) that defines the azimuth. The azimuth is the backsight to point 'STN2'.

Operation Code 5

This code allows for the entry of a feature code after the first observation.

Only Info 1 (WI 42) and not Info 2 and 3 are read and assigned to the next point with the code. Info 2 and Info 3 are ignored as they define the size at which the object shall be displayed in LISCAD.

Example:

410050+00000005 42....+0000TREE 43....+00001500 44....+00001000

Operation Code 9

This allows for the independent entry of a fixed coordinate.

42. Point Identifier

43. Easting or Northing

44. Northing or Easting

45. Reduced Level

Example:

410050+00000009 42....+0000STN1 43....+ 00100000 44....+00200000 45....+00010000

Operation Code 15

New point identifier. This operation code allows the user to assign a point identifier defined in the code to the next observation.

Example:

410050+00000015 42....0000STN1
110051+...observation

The Point Identifier is assigned to the next observation (110051), i.e. the target of that observation will have the Point Identifier STN1.

Operation Code 98

Ignores a range of measurements. This code allows the user to ignore a group of measurements. The Start Point Identifier to End Point Identifier (Inclusive) are ignored.

42. Start Pt Identifier

43. End Pt Identifier

Example:

410050+00000098 42....0000STN1 43....000STN15

Note: This operation code can be entered anywhere within the GSI file but still applies to the referenced Pt Ids.

Operation Code 99

Ignores the previous measurement.

Example:

110049+observation
410050+00000099

The observation recorded by 110049 is ignored.

Assign Settings

In the **Settings tab** of the **Assign** dialog only those data items (General, GPS, TPS, Level or Points) and options will be visible for selection which are relevant for the data to be imported. If there is no relevant setting at all, then the whole property page will not be visible. Combined raw data (e.g. GPS **and** TPS observations contained in one job) is possible with SmartWorx. De-select one or the other if you want to import only one type of raw data.

You may define the following settings:

General:

The **General** section of the **Settings** Report-View is visible if any of the following options are relevant for the data to be imported:

Resolve coding conflicts using:

If codes are included in the data to be imported it might become necessary to resolve coding conflicts. A coding conflict is a conflict of coding information from imported data with codes that already exist in a project. This can occur if you import data for a particular point that already exists with a different code attached to it or if there is a different definition of the same code. Via in-line editing (slow double-click) select one of the following options from the **Setting** column:

- **Ignore** to accept the values already stored in the Project.
- **Overwrite** to store the value from the imported data.

Note: If the same code has been used with points each containing different attribute names, then for both options new attributes will be appended to those already attached to the existing code.

In addition, if the numerical range for the same attribute is different, the numerical range is extended.

Import 'use flag' status for averaged points

If the job data to be imported contains averaged points then tick this option if you want to retain the 'use flag' status as set in the field. If you un-check this option the use flag will be set to **Automatic** in the office software and the average will be calculated according to the settings of the project.

Note: This option is only visible if the data contains at least one averaged point, for the calculation of which the use of the measured points has been manually modified in the field.

Ignore automatically recorded points:

If you have measured auto points in the field these automatically recorded points are stored in sequential order in the raw data file (MDB = Measurement DataBase). They may also be stored in the point database (GeoDB, DBX). This setting allows you to ignore automatically recorded points.

Import coordinate system and components:

If the data to be imported has a coordinate system (other than WGS84 or None) attached this option becomes available. Check the box if you want to import the coordinate system and its components (Transformation, Ellipsoid and Projection) in addition to the data.

Note, that geoid models have to be attached manually if **Geoid model field files** have been used with the data to be imported.

When importing coordinate systems with attached **CSCS model field files** then the CSCS model from which the field file was generated is automatically included if possible.

- **Attach coord system:** Via in-line editing (slow double-click) select to use either the coordinate system of the imported job within the project you are assigning the data to or **None** from the **Setting** column. If you select **None** the coordinate system used in the field will not automatically be attached to the project.

In case you import several jobs with different coordinate systems attached, select the correct coordinate system from the list.

Import coordinates as type (only available for TDS (Points only)):

In a TDS raw data file points measured with GPS are stored with WGS84 and with Local Grid coordinates. When importing **TDS (Points only)** data you can select which representation of the coordinates shall be imported.

GPS data:

GPS:

Check **GPS** if GPS observations are contained in the data and if you want these observations to be imported to the selected project. If you de-select GPS none of the following options will apply.

Observation rate:

Enables you to filter out a certain number of observations. E.g. the original rate is 1 second but you want to import observations every 15 seconds only. Select an Observation rate from the list if you want to import the data with an observation rate lower than the existing rate. The default is **Use all**.

Note: The program imports the smallest common multiple of the value set and the original observation rate. E.g. if the original rate is 15 seconds and you select a rate of 20 second, only observations every 60 seconds are imported.

Merge intervals:

The **Merge intervals** functionality is normally used when importing data from permanent reference stations. If more than one GPS interval is contained in the data then this function will merge any observation intervals that conform to the following points:

- The gap between any two consecutive intervals is less than 30 minutes.
- The Point Ids are identical for consecutive intervals.
- The Antenna Type is identical for consecutive intervals.

Connect intervals to mixed tracks (only for RINEX):

Check this box if you import RINEX data measured as kinematic tracks with static intervals (Mixed Track (MXD)).

Preferred antenna definitions (only for RINEX):

When importing RINEX data the LEICA default antenna definitions are automatically assigned to the observation interval if the RINEX file header includes the IGS antenna name. If, however, a user-defined antenna exists in the **Antenna Management** with the same name as the IGS antenna name, then you are given the choice to assign either the **LEICA default** antenna or the **user-defined** antenna.

TPS data:

TPS:

Check **TPS** if TPS observations are contained in the data and if you want these observations to be imported to the selected project. If you de-select TPS all TPS observations contained in the data will be ignored during import.

Level data:

Level:

Check **Level** if Level observations are contained in the data and if you want these observations to be imported to the selected project. If you de-select Level all Level observations contained in the data will be ignored during import.

Points:**Points:**

When importing raw data from a job which contains points without observations, such as manually entered points or points computed with COGO, then these points can be included or excluded from the import procedure. Check **Points** if you want these points to be imported to the selected project.

When importing **Database points (DBX, GeoDB)** and the data contains **objects measured using offsets or COGO points** then you have the option to import only these points.

If objects that have been measured using offsets or COGO points have not been imported during the standard **SmartWorx raw data** import and if you want them to be added to your project you have to run a second import selecting the file type **Database points (DBX, GeoDB)**. In the **Settings** page check the option **Import only objects measured using offsets or COGO** to add the line/ area objects to your project without importing the raw data twice.

View Data (GPS)

This Property-Page allows raw data to be checked and modified prior to assigning them to a Project.

The following information can be viewed and edited via **in-line** editing:

Point Id:

Modify the Point Id if necessary.

Height Reading/ Measurement type:

Modify the Antenna details for a single selected interval, a complete track (chain) or a complete job. The effective antenna height can be changed either by directly changing the **Height Reading** or by changing the **Measurement type** to an antenna which has a horizontal offset.

Note: A change in the Antenna details during import will not be applied to measured rover coordinates. To effectively shift the rover coordinates import the raw data and use the **Edit Interval** functionality inside the project.

Attribute name:

Modify the Attribute name(s) if necessary.

Annotations:

Modify the annotations if necessary. A maximum of four annotations is permitted. In the in-line edit field they are separated by forward slashes ('/'). You may modify the annotations string directly or enter new annotations according to this rule. If annotations are not correctly separated by a forward slash they will be interpreted as belonging together.

Single points/ observations may be **activated** or **de-activated** to **include/ exclude** them into/ from import. De-activated points/ observations are **not** taken over into a Backup and they are **not** listed in the Fieldbook.

If you select a series of points all of them can be de-activated or activated at once.

De-selecting the static part of a kinematic chain will cause the whole chain to be de-selected.

Note:

- The information displayed in the View data (GPS) report view is different when you import GPS data from a TDS raw data file.

See also:

[View Data \(TPS\)](#)

[View Data \(Level\)](#)

[View Data \(Points\)](#)

View Data (TPS)

This Property-Page allows raw data to be checked and modified prior to assigning them to a Project.

You can view the **Point Id** of the station setup and the **Target Id**, **Instrument** and **Target Height** as well as the measurements: **Direction**, **Distance** and **Vertical Angle**. **Thematical coding** information is displayed, too. More information can be viewed by [switching on additional columns](#) in the Report View.

The following information can be viewed and edited via **in-line** editing:

Point/ Target Id:

Modify the Point and/ or Target Id if necessary.

Instrument height:

Modify the Instrument height if necessary.

Attribute name:

Modify the Attribute name(s) if necessary.

Annotations:

Modify the annotations if necessary. A maximum of four annotations is permitted. In the in-line edit field they are separated by forward slashes ('/'). You may modify the annotations string directly or enter new annotations according to this rule. If annotations are not correctly separated by a forward slash they will be interpreted as belonging together.

Single points/ observations may be **activated** or **de-activated** to **include/ exclude** them into/ from import. De-activated points/ observations are **not** taken over into a Backup and they are **not** listed in the Fieldbook.

If you select a series of points all of them can be de-activated or activated at once.

Note:

- The information displayed in the View Data (TPS) report view depends on whether you import TPS data from a SmartWorx job or from a GSI file or from a TDS raw data file
- If [Survey Observations](#) are modified these modifications will be taken over into the Fieldbook but modifications of [Setup Observations](#) are **not** taken over into the Fieldbook. .

See also:

[View Data \(Level\)](#)

[View Data \(Points\)](#)

View Data (Level)

This Property-Page allows level raw data to be checked prior to assigning them to a Project.

- Via **in-line** editing you can **rename** lines or **exclude** lines in this tab if required.

Single level lines may be **activated** or **de-activated** to **include/ exclude** them into/ from import. If you select a series of lines all of them can be de-activated or activated at once.

View Data (Points)

This tab is only displayed if the data to be imported contains points which are neither GPS, nor TPS, nor Level. These can be either COGO calculated points, offset points, manually entered points or other point triplets not related to a measurement.

It will also be displayed if you:

- Import **Points only** from *SmartWorx* (**DBX**) or from *GPS500* (**GeoDB**) or from a TDS raw data file (**TDS (Points only)**)
- Import GSI data which contains only Point information (**GSI (Points only)**).

Via **in-line** editing you can modify the **Point Id**. Single Points may be **activated** or **de-activated** to **include/exclude** them into/ from import. If you select a series of points all of them can be de-activated or activated at once.

Fieldbook Report

For *SmartWorx*, *GPS500* and *GPS300* a **Fieldbook** report can be generated during Raw Data import. To get an overview on the raw data collected in one or more jobs in the field:

- Click the  **Fieldbook** button in the lower left corner of the **Assign** dialog to get a report on all jobs which have been selected for Import.

The report opens in a stand-alone window and is listed in the **Open Documents** list bar.

Stand-alone reports can be saved as HTML files or printed:

- To save a report as an HTML file right-click inside the report and select **Save As...**
- To print a report right-click inside the report and select **Print**. A **Print Preview** is also available from the context menu.
- To select the **contents**, the **coordinate format** and the **layout** of the report right-click and select **Properties...** from the context menu or click  from the **Reports** toolbar. For jobs measured with GPS the **coordinate format** can be set to either show *WGS84 Geodetic* coordinates or *WGS84 Cartesian* coordinates or *Local Grid* coordinates. When set to *Local Grid* the **height mode** of the coordinates can be switched separately.

For further details about Report Template Management refer to: [Configure a Report](#).

When the report has been configured to display all possible sections it presents you with the following information:

- Job Information
- Coordinate System Information
- Points & Observations
- Atmospheric Information
- Images

Job Information

[Example:](#)

Job Information

Job name:	RT-Sample
Date created:	03/24/1999 14:10:33
Time zone:	1h 00'
Coordinate system name:	Sample RT
Application software:	LGO 1.0
Firmware:	Leica Firmware 1.21
Codelist name:	RT-Sample

This section gives you general information on the job to be imported, like the job name, creation date and time, the time zone and the attached coordinate system. The firmware version with which the job has been measured is given as well as the number of the manually occupied points. The averaging limit as defined in the job properties as well as the number of points which exceed the limit are listed in this section, too. If a codelist has been used in the field its name is listed as part of the job information section.

Coordinate System Information

Example:

Coordinate System Information

Coordinate system name:	Sample RT
Date created:	03/24/1999 16:17:43
Transformation name:	Sample WGS-Bess
Transformation type:	Classical 3D
Height mode:	Ellipsoidal
Residuals:	1 / distance
Local Ellipsoid:	Bessel
Projection:	UTM32 North
Geoid model:	-
CSCS model:	-

The **Properties** of the Coordinate System which has been used in the field with the job are listed.

In different sections, which may be switched on and off manually in the **Report Template Properties: Contents** page, the **Transformation details**, the computed **Residuals** for the identical (common) points and a **List of the identical (common) points** and their coordinates is given.

Example:

Transformation details

3D-Helmert transformation

Number of common points: 4
 Transformation model: Bursa-Wolf

No.	Parameter	Value
1	Shift dX	-660.0710 m
2	Shift dY	-13.5520 m
3	Shift dZ	-369.3360 m
4	Rotation about X	-0.8 "
5	Rotation about Y	-0.6 "
6	Rotation about Z	-1.0 "
7	Scale	-5.6614 ppm

Residuals

Grid:

System A	System B	Point type	dE [m]	dN [m]	dHgt [m]
1	1	Position + height	0.0011 m	0.0040 m	0.0016 m
2	2	Position + height	-0.0028 m	-0.0030 m	-0.0016 m
4	4	Position + height	0.0033 m	0.0026 m	-0.0016 m
7	7	Position + height	-0.0016 m	-0.0036 m	0.0016 m

Points & Observations

In this section of the report the final point coordinates and their quality as derived in the field are listed. For GPS real-time measurements the reference site will be listed as well.

[Example:](#)

GPS Coordinates

Baseline	Reference: TP306	Rover: BM1	
Local Coordinates:			
Easting:	549211.5189 m	548995.1552 m	
Northing:	5249188.0590 m	5248368.2176 m	
Ellip. Hgt:	463.1459 m	464.7334 m	
Time span:	03/24/1999 14:10:23 - 03/24/1999 14:10:28		
Duration:	4"		
Quality:	Sd. E: 0.0042 m	Sd. N: 0.0069 m	Sd. Hgt: 0.0130 m
	Posn. Qlty: 0.0080 m	Sd. Slope: 0.0127 m	
Codelist:	RT-Sample		
Codegroup:	SURVEY		
Code description:	BENCH MARK		
Code type:	Point		

In the [Report Template Properties](#) additional **Contents** may be switched on manually:

- GPS Coordinates:** information on Antenna, Time, Quality, Baseline vectors, DOPs, Annotations and the [RTK Info](#) on the solution type, the network type (if a reference station network has been used to compute the solution) and the RTK data format.
- TPS Coordinates:** information on Setup, Setup Time, Setup Height, Setup Quality, Setup Method, on Observation, Observation Time and Observation Quality.
- GPS/ TPS Automatic Points** can be switched on or off for the fieldbook report.
- TPS Traverse Results:** If the SmartWorx Traverse application has been used with the selected job, information and accuracies for the traverse can be displayed.
- TPS Set of Angles:** If the SmartWorx Sets of Angles application has been used with the selected job the results and the contained measurements can be displayed.
- Calculated Points:** information on calculated points such as COGO points.
- Control Points:** information on Control points manually entered or imported into the job.
- Offset Points:** information on points that have been measured using offsets.
- Coding:** information on the Codelist Name, on the Code Group, Code Type, Code Description and the Attributes used with the point.
- Mean Coordinates and Differences:** If a coordinate is recorded more than once for the same Point Id then a **Mean** of the coordinates will be calculated automatically on the instrument.

The **Mean Coordinates and Differences** section of the report shows the Mean Coordinates, the Difference of the measurements to the Mean and the Quality and the Coordinates of each measurement. If a point lies outside the averaging limit as set on the instrument then this measurement will be marked with  in the fieldbook.

This section of the report is very similar to the [Mean Coordinates & Differences Report](#) as written for the mean coordinates calculated within a project.

- Stakeout Results:** If the SmartWorx Stakeout application has been used with the selected job, stakeout results such as differences, qualities and coordinates can be displayed.

Atmospheric Information

In this section of the report the **Temperature**, **Pressure** (and Elevation above MSL) and the **Relative Humidity** as well as the calculated **Atmospheric ppm** values are listed for TPS observations. This section is always displayed, when the values were changed in the field.

[Example:](#)

Atmospheric Information	
Temperature:	25.0 °C
Pressure:	916.7 mbar
Elev. above MSL:	800.0 m
Relative Humidity:	60 %
Atmospheric PPM:	39.0

Images

In this section of the report the **Images** stored with the job to be imported are listed. For each image the **file name** is given together with the **date and time** when the picture has been taken and the **objects** (points, lines/areas, TPS setups) to which the image is linked. If an image is **not linked** a dash is shown.

Note:

- Modifications of the data in the **View Data** pages are reflected in the output in the Fieldbook reports. If you wish to generate a fieldbook showing the original data create it **before** you make any modification in the **View Data** pages.
- If you wish to display the fieldbook in local grid coordinates with orthometric heights and the coordinate system of the job contains a CSCS model field file and/ or a geoid model field file, then you have to ensure that the field file(s) can be found either in the folder where the job is stored or in the identical relative path as on the local memory device.

ASCII Data

ASCII Import

ASCII Import is used to Import ASCII files into a project. ASCII files can consist of coordinate lists or ASCII file Templates. Template files are used to specify and store the settings of user defined file formats.

[SKI ASCII File Format](#) is a special pre-defined Leica GeoMax ASCII file format.

For more information see also:

[Notes about importing Points.](#)

Depending on the format of data to be imported, the procedure to import the files may be different.

Select from the list to learn more about ASCII File Import:

[How to import SKI ASCII files \(*.asc\)](#)

[How to import Text files \(*.prn, *.txt, *.csv\)](#)

[How to import Text file Templates \(*.uat\)](#)

[How to Save Text file Templates \(*.uat\) to a file](#)

Notes about importing Points

Importing points via ASCII file has certain restrictions, especially if points are imported that already exist in a Project.

Import to a Project (more than one coordinate triplet may exist for a point):

- Several coordinate triplets for the same point may be imported at once.
- If a coordinate triplet already exists with different coordinates, then for all **Coordinate Classes**, except for coordinate class *Measured*, a new 'Point Id (2)' is created. Coordinate triplets of class *Measured* are added to an existing point and a new average is calculated.
- If the Point Id does not already exist a new point is created. If a point with **Coordinate Class** *Average* or *Reference* is imported, the class is converted to class *Control*.

Related topics:

[ASCII Import](#)

[Notes about Drag and Drop points](#)

SKI ASCII File Import

SKI ASCII File Import allows to import coordinates that are stored in [SKI ASCII File Format](#).



1. From the **Import** menu select **ASCII Data...**, or press  (Import ASCII Data) in the **Tools** List Bar.
2. Under Files of type select SKI ASCII file (*.asc).
3. From the browser select a file. The file extension must be 'asc'.
4. Select the **Default Coordinate Class**. Choose between **Control** and **Estimated**. The Default Coordinate Class will only be applied to points without class information.
5. Select **Import** to proceed with the **Assign** dialog or select **Cancel** to abort the function.
6. Select the **View data** tab if you want to pre-view or modify the data to be imported. Rename points or exclude points in this tab if required.
7. Under the **General** tab select a **Project** from the list and press the **Assign** button to import the data into the selected Project or **Close** to abort the function.

Tip:

- The Assign dialog has the same functionality as the [Project Management](#). E.g. Select New... from the context-menu (right-click) if you want to create a new Project during the import procedure.

Text File Import

Text file import allows coordinates that are stored in a user-defined ASCII format to be imported. A user-defined ASCII template may be defined and stored in an ASCII File Template. If no ASCII File Template is defined prior to importing coordinates the system will automatically open an [Import Wizard](#) allowing you to create a new template.



1. From the **Import** menu select **ASCII Data...**, or press  (Import ASCII Data) in the **Tools** List Bar.
2. Under **Files of type** select **Text files (*.prn, *.txt, *.csv, *.ssv)**.
3. From the browser select a file. The file extension must be 'prn', 'txt' or 'csv'
4. Select a pre-defined **Template** from the list or select **None** if you want to create a new template.
5. Check **View/ Edit** if you want to modify the selected template by using the [Import Wizard](#).
6. Select the **Coordinate System**. Choose between **WGS 84** and **Local**.
7. Select the **Height Mode**. Choose between **Ellipsoidal** and **Orthometric**.
8. Select **Import** to proceed with the **Assign** dialog or select **Cancel** to abort the function.
9. Select the **View data** tab if you want to pre-view or modify the data to be imported. Rename points or exclude points in this tab if required.
10. Under the **General** tab select a **Project** from the list and press the **Assign** button to import the data into the selected Project or **Close** to abort the function.

Note:

- If you import thematically coded data for a particular point into a project where a point of the same Id already exists with a different code attached to it then this will result in a so-called **coding conflict**. This conflict will be resolved in that the codes that are already stored in the project will be accepted and the **codes defined in the text file will be ignored**.

Tip:

- The Assign dialog has the same functionality as the [Project Management](#). E.g. Select New... from the context-menu (right-click) if you want to create a new Project during the import procedure.

Select from the list to learn more about Text Files Import Templates:

[Add new Templates to the list using the Import Wizard](#)

[Delete Templates from the list](#)

[Save Templates as a File \(*.uat\)](#)

[Import Templates from a File \(*.uat\)](#)

User Defined ASCII File Import Wizard

User Defined ASCII File Import Wizard

The Import Wizard enables you to define a template to assist with the import of user defined ASCII files. To use the Wizard follow the instructions given by the program in step 1 to step 4.

The Wizard will startup automatically under the following conditions:

- If the template **None** is selected
or
- If **View/ Edit** is checked.

Note:

- If you intend to import **Geodectic** coordinates from a text file the coordinates have to be in one of the following formats:

DD.DDDD

1	47.156894112	-9.249561234	474.7037
2	-47.156894112	9.249561234	474.7037
3	47.156894112	9.249561234	474.7037
4	-47.156894112	-9.249561234	474.7037

with the "-" sign indicating West and South.

DD.MMSS

1	47.243172146	-9.370502956	474.7037
2	-47.243172146	9.370502956	474.7037
3	47.243172146	9.370502956	474.7037
4	-47.243172146	-9.370502956	474.7037

with the "-" sign indicating West and South.

DD MM SS (NSEW)

1	47 24 31.72146 N	9 37 05.02956 W	474.7037
2	47 24 31.72146 S	9 37 05.02956 E	474.7037
3	47 24 31.72146 N	9 37 05.02956 E	474.7037
4	47 24 31.72146 S	9 37 05.02956 W	474.7037

The given examples show excerpts from tab-delimited text files. You may also use spaces as a separator. In that case choose **Position** in the first Wizard page and position the column separators manually in the second step.

In step 3 of the Import Wizard select the format that suits the text file from the **Format** drop-down list.

- In step 4 of the Import Wizard enter a **Template Name** to add a new template to the list. In addition click **Save As** to store the template to a file.

Select from the list to learn more about Text Files Import Templates:

[Delete Templates from the list](#)

[Save Templates as a File \(*.uat\)](#)

Import Templates from a File (*.uat)

Delete Text File Import Templates

- Right-click on the **Template** drop-down list and select **Delete**.
Note: Alternatively you can also select **Delete All**.

Save Text File Import Templates as a File

This function allows the Text File Import-Templates to be written to a file.

1. Right-click on the **Template** drop-down list and select **Save As...**
2. From the browser select the desired directory.
3. Enter a **File name** without extension.
4. Click on **Save** to confirm, or **Cancel** to abort the function. A file with the extension "uat" will be stored.

Note:

- The export settings file (*.uat) can be transferred to another computer to import it into another Office database.

See [Import Text File Templates from a File](#)

Alternatively:

- Use the **Save As** function in step 4 of the [User Defined ASCII File Import Wizard](#) to export the template to a file.

Import Text File Import-Templates from a File

ASCII File Templates for import are binary files (*.uat) that contain the information regarding the format of user defined ASCII files to be imported. They may be created using the [Import Wizard](#) of Text File Import. This feature allows templates to be transferred between different installations of LGO or Flex Office.



1. From the **Import** menu select **ASCII Data...**, or press  (Import ASCII Data) in the **Tools** List Bar.
2. In the **Import ASCII File** dialog right-click in the **Template** combo box and select **Import...** from the context menu.
3. From the browser select a file. The file extension must be *.uat.
4. Press **Open**. Back in the **Import ASCII File** dialog the template will be added to the **Template** list.

SKI ASCII File Format

SKI ASCII file format is a pre-defined Leica GPS file format used to exchange point coordinates and baseline vectors between different installations of LGO, other Leica software, and third party software which supports the format.

SKI ASCII file format types:

[SKI ASCII Point Coordinate Format](#)

[SKI ASCII Baseline Vector format](#)

Precise Ephemeris

Precise Ephemeris Import

This component allows you to import precise ephemeris information into the LGO database. A Precise ephemeris can be used to improve accuracy when processing long baselines that have been observed for long periods of time. Precise ephemeris files must be in the following format:

NGS/NOAA SP3-P (Position) format.

The SP3-P format is an internationally accepted standard ASCII format for precise ephemeris.

There are several services that provide precise ephemeris data, e.g.:

- IGN Global Data Center
- IGS International GPS Service for Geodynamics

Select from the Index to learn more about Precise Ephemeris:

[Internet Download](#)

[How to Import Precise Ephemeris](#)

How to Import Precise Ephemeris

1. From the Import menu select **Precise Ephemeris....**

2. From the browser select a file.

Note: The file extension must be 'SP3'

Check **Include subfolders** and select a directory if you wish to import automatically the data of all sub-directories contained in this directory.

3. Press **Import** to store the data in the LGO database or **Cancel** to abort the function.

On pressing **Import**, a message follows that the ephemeris have been successfully imported.

Note:

- The imported Precise Ephemeris are available for all projects.
- Make sure the Precise Ephemeris cover the whole period of observations you want to process.

Internet Download

This tool is intended to support an automated download of different GPS data such as RINEX raw data and [Precise Ephemeris](#). YUMA almanacs for use in the [Satellite Availability](#) tool can also be downloaded. It can be selected from the main menu under **Tools**, the menu entry being called **Internet Download**. This option will always be active, no matter whether a project is open or not. Whether the site(s) shall be selected automatically or manually has to be set under [Tools - Options - Internet](#).

On the **Internet download** sheet you will find the following three pages:

[Internet download: General](#)

[Internet download: Site logfile](#)

[Internet download: Add/ Edit custom sites](#)

Tip:

- If you are currently working on a project and decide to invoke the **Internet Download** tool, then you may do so with holding the *Shift* or *Ctrl*-key pressed. The system will switch to **Automatic** site selection, regardless of your previous settings under [Tools - Options - Internet](#). The centre coordinates of the active project will be taken as the centre coordinates for the site location. As the date for download the project's date will be taken. If your measurements comprise more than one day a "centre"-time will be determined.

This functionality may be used as a shortcut to download Precise Ephemeris for a project you are actively working on.

Alternatively:

Precise ephemeris can also be downloaded from the IGS (International GPS Service for Geodynamics) network without the help of the **Internet Download Tool**. You have two choices: either you download them from the Internet or via FTP:

FTP:

<ftp://igscb.jpl.nasa.gov/igscb/product/>

Internet:

<http://igscb.jpl.nasa.gov/igscb/product/>

1. Download the file to your computer.
2. Continue with [How to Import Precise Ephemeris](#).

Note:

The precise ephemeris files from the IGS network are compressed. To decompress these files use the tools stored under the following Internet address: <http://igscb.jpl.nasa.gov/igscb/software/compress/dos/> Alternatively, you may use WinZip to decompress these files.

Precise ephemeris files for **GLONASS** satellites can be downloaded from <ftp://cddis.gsfc.nasa.gov/lonass/products/>

Precise Ephemeris Management

Precise Ephemeris are imported directly into the database and can be used by different projects without being bound to one special project. This is why you are presented with a functionality under **Tools – Precise Ephemeris Management** that offers you to view those precise ephemeris you have already imported and delete those you do not need any longer. The functionality will always be active.

When invoked a new window with a simple report view (i.e. no tree-view) pops up, listing all precise ephemeris currently stored in the database. The report view consists of 5 columns showing:

Date:

Lists the date of the first data set in the file. Due to overlappings between two days, this may be the date of the day before. Typically, each precise ephemeris file is valid for only one day. Then **Date** lists the actual date of the precise ephemeris.

GNSS Type:

Specifies whether only GPS or GPS/GLONASS satellites are included in the file.

Date of Import:

Specifies the date when the particular file was imported.

Number of Satellites:

Lists the number of satellites covered by the selected file.

Satellites:

Lists the satellites' numbers themselves. G denotes GPS satellites and R denotes GLONASS satellites.

Agency:

Names the agency, which delivered the specific precise ephemeris file.

- When you want to delete a set of precise ephemeris from the database right-click on the selected lines and pick "Delete" from the context menu. A message box will be displayed, which gives you the chance to either delete the data sets one by one, to delete them all at once or to abort the function.
- When you want to import a new set of precise ephemeris you can do so from the same context menu or from the window background of the **Precise Ephemeris Management** itself. Clicking **Import** links you to the [Precise Ephemeris option of the main menu](#). After **Import** the report view will be updated.

Export

Export

This component is used to export GPS raw data from the Office database to RINEX format, coordinate files to SKI ASCII or a user-defined ASCII format and coordinate files for GIS or CAD systems.

Select from the list below to learn more about Export:

[RINEX Export](#)

[ASCII Export](#)

[GIS / CAD Export](#)

RINEX

RINEX File Export

RINEX Export is used to write the GPS raw data contained in a Project to RINEX formatted files. You may either export all raw data from a project or select individual tracks. To export individual tracks select **Export to RINEX** from the Context-Menu (right-click) in the GPS-Processing view.

How to export GPS raw data to RINEX formatted files:

1. From the **Export** menu select **RINEX...**, or press  (Export RINEX Data) in the **Tools** List Bar.
2. If no Project is active select one from the list and click **Export**.
3. From the browser select the desired directory.
4. Modify the **file name** if necessary.
Note: By default a file name is suggested with the first 4 characters being equal to the first station name contained in the data. The remaining characters are set automatically according to the RINEX file naming convention.
5. Choose whether you want to save the file as Rinex files (version 2.1) or as Rinex files (version 3.01).
6. Check **Separate files for different tracks** if you wish to write a separate file for each track.
Note: The files will be named according to the Point Id, Day of Year and Session number.
7. Check **Ignore windows** if you wish to ignore any window selection made in **GPS-Processing**.
8. Check **Create new file every # hrs** if you want to split the files into pre-defined intervals. Enter a value between 1 and 24 hours.
Note: This function is available for static intervals only. *Separate files for different tracks* has to be checked before this function becomes available.
9. Select the **GNSS Type** to be exported. You may choose whether you want to export **All** (GPS, GLONASS and Galileo) or **GPS L1+L2 only**.
10. Enter a name for **Observer** and/or **Agency** if you want these names to appear in the header of the RINEX observation file.
11. Press **Save** to write the files or **Cancel** to abort the function.

Alternatively:

- Individual Intervals / Tracks of a Project may be exported to RINEX from within the GPS-processing View. See [Export to RINEX via GPS-processing](#).

ASCII

ASCII Export

ASCII Export is used to generate ASCII files from a Project. ASCII files can consist of coordinate lists or ASCII file Templates. Template files are used to specify and save the settings of user-defined file formats.

Depending on the format of data to be exported the procedure to export the files may be different.

Select from the list below to learn more about ASCII Export:

[How to export User-defined ASCII Files](#)

[How to export Custom ASCII Files \(*.cst\)](#)

[How to export SKI ASCII Files.](#) The [SKI ASCII File Format](#) is a special pre-defined Leica internal file format.

[How to export NGS G- or B-files \(*.ngs\)](#)

SKI ASCII File Export

SKI ASCII File Export allows points to be extracted from projects to ASCII files in [SKI ASCII File Format](#).



1. From the **Export** menu select **ASCII...**, or press  (Export ASCII Data) in the **Tools** List Bar.
2. If no Project is active select one from the list and click **Export**.
3. Select **Save as type**: SKI ASCII File (*.asc)
4. From the browser select the desired directory.
5. Enter a **File name** without extension.
Note: The file extension will be added automatically (*.asc)
6. Modify the [Settings](#).
7. Press **Save** to write the file or **Cancel** to abort the function.

SKI ASCII File Format

SKI ASCII File Format

SKI ASCII file format is a pre-defined Leica GPS file format used to exchange point coordinates and baseline vectors between different installations of LGO, other Leica software, and third party software which supports the format.

SKI ASCII file format types:

[SKI ASCII Point Coordinate Format](#)

[SKI ASCII Baseline Vector format](#)

SKI ASCII Point Coordinate Format

This format may be used to import coordinates into LGO. It may also be used to write coordinates into an ASCII file from LGO. The same format may be used to exchange baseline vectors. See [SKI ASCII Baseline Vector format](#) for further information.

Example (showing one point only):

```
@%Unit: m
@%Coordinate type: Grid
@%Reference ellipsoid: Bessel
@%Projection set: Austria
@#Hochpyhra 4130847.731 1099146.872 943.204 32
@$ 0.078046132 1.00003312 0.99964397 0.99967708
@& 0.0042 0.038622 0.017198 0.043753 0.026479 0.027672 0.143756
@1Code
@2Codename
@3Code Group
@AAttribute=Attribute Value
@4Annotation 1
@4Annotation 2
@4Annotation 3
@4Annotation 4/Seismic record
```

The first two characters of each line contain the keyword. Lines which do not have a keyword are ignored when reading the file. When exporting from LGO there is an option to omit the header lines and keywords.

Keywords are used to identify the type of information contained in each line:

<u>Keyword</u>	<u>Information type</u>
@%	Header lines
@#	Point and coordinate information
@\$	Convergence angle and scale factor information
@&	Variance-Covariance information
@E	Error Ellipse (absolute)
@R	Reliability
@1	Code
@2	Code Description
@3	Code Group
@A	Attribute
@4	Annotations
@F	Free Code
@G	Free Code Description
@H	Free Code Information Record
@N	Field Note

Header lines:

There are a maximum of 4 header lines possible. The first two header lines are compulsory, the last two are optional for the input file but are always included in the output file unless the option to omit them has been selected. The sequence of the header lines has to be strictly observed.

Fixed identifier

Variable information

@%Unit:

Indicates the units used for length information like coordinates, geoid separation etc. Separator between fixed identifier and variable information is minimum one blank. Allowed variables are:
m: for meter
fts: for U.S. survey foot
fti: for international foot

@%Coordinate type:

Defines the coordinate system of the represented coordinates. Separator between fixed identifier and variable information is minimum one blank. Allowed variables are:
Cartesian: for cartesian coordinates
Geodetic: for geodetic coordinates
Grid: for grid coordinates

@%Reference ellipsoid:

Defines the reference ellipsoid tied to the coordinates. If this information is not used or the specified reference ellipsoid is not available in the database when reading in the file, the reference ellipsoid will be set to undefined automatically. It can be specified and allocated at a later stage.

@%Projection set:

Defines the projection set tied to the coordinates. If this information is not used or the specified projection set is not available in the database when reading in the file, the projection set will be set to undefined automatically. It can be specified and allocated at a later stage.

Point and coordinate information:

Each point must contain the line with the coordinate information. In addition, more information like thematical coding and the variance covariance information can be attached with additional lines. These lines have to follow immediately the first line of the point and coordinate information.

Fixed identifier

Variable information

@#

Point identifier (16 characters no blanks between @# and point id.).
Coordinates according to the defined type. (Cartesian, geodetic or grid)
Geoid separation N.
Coordinate Class (CTRL, ADJ, REF, MEAN, MEAS, SPP, NAV, EST)
Coordinate Quality
Coordinate Type.

@\$

Convergence angle
Grid Factor
Elevation Factor
Combined Factor (Grid x Elevation).
Note: This information only appears if the Coordinate Type is Grid and the Map Projection allows the calculation of these values, i.e. if the projection is of type Transverse Mercator (TM), UTM, Lambert Two or Double Stereographic.

@&

Sigma a posteriori (in the selected units) elements of the cofactor matrix for that point

- (q11, q12, q13, q22, q23, q33).
- @E Elements of absolute error ellipse (Semi-major, Semi-minor, Orientation in radians, Height)
 - @R Reliability for that point (R-Lat., R-Long., R-Height)
 - @1 Code with a maximum of 16 characters, immediately following the fixed identifier.
 - @2 Code description with a maximum of 30 characters, immediately following the fixed identifier.
 - @3 Code Group with a maximum of 30 characters, immediately following the fixed identifier.
 - @A Attribute and attribute value. Attribute followed by = sign then attribute value.
 - @4 4 lines for annotations. Each line may contain a maximum of 40 characters, following immediately the fixed identifier.
Note: The fourth line contains the seismic record if this has been activated on the Controller.
 - @F Free Code with a maximum of 16 characters, immediately following the fixed identifier.
Note: Only if the coordinates are sorted by time it is possible to use free codes.
 - @G Free Code Description with a maximum of 30 characters, immediately following the fixed identifier.
 - @H Free Code Information Record with a maximum of 30 characters, immediately following the fixed identifier.
 - @N Free Code Field Note with a maximum of 128 characters, immediately following the fixed identifier.

Coordinate types:

The last value in the line with the fixed identifier @# specifies the type of coordinates contained in that line.

Cartesian coordinates (type 11-19)

						<u>Type:</u>
point id	X	Y	Z	N		11
point id	X	Y	Z			12
point id	X	Y	Z			13 *
point id	X	Y	Z	N		14 **
point id	X	Y	Z			15 ***

Only points with type 11,12,14 can be edited.

- * No height information was available for the original coordinates (type 23). To obtain X, Y, Z the height zero was assumed.
- ** The X, Y, Z coordinates are based on original orthometric height information (type 24).
- *** The X, Y, Z coordinates are based on original orthometric height information (type 25).

Geodetic coordinates (type 21-29)

					<u>Type:</u>		
point id	lat	Long	ell. hgt	N		21	
point id	lat	Long	ell. hgt			22	
point id	lat	Long				23	*
point id	lat	Long	orth. hgt	N		24	**
point id	lat	Long	orth. hgt			25	***
point id			ell. hgt	N		26	
point id			ell. hgt			27	
point id			orth. hgt	N		28	
point id			orth. Hgt			29	

* In case of transforming to Cartesian coordinates, a height of zero is assumed. (corresponds to type 13)

** When transforming to Cartesian coordinates, transformation is based on orthometric height and the resultant Cartesian coordinates correspond to type 14.

*** When transforming to Cartesian coordinates, transformation is based on orthometric height and the resultant Cartesian coordinates correspond to type 15.

Grid coordinates (type 31-39)

					<u>Type:</u>	
Point id	East	North	ell. Hgt	N		31
Point id	East	North	ell. Hgt			32
Point id	East	North				33
Point id	East	North	orth. Hgt	N		34
Point id	East	North	orth. Hgt			35
Point id			ell. Hgt	N		36
Point id			ell. Hgt			37
Point id			orth. Hgt	N		38
Point id			orth. Hgt			39

SKI ASCII Baseline Vector format

This format is used when baseline vectors are required (e.g. as input into an adjustment program). The SKI ASCII Baseline Vector format is an extension of the [SKI ASCII Point Coordinate format](#).

Example:

```
@%Unit: m
@%Coordinate type: Cartesian
@%Reference ellipsoid: WGS 1984
@#000001 4264339.8751 725162.0216 4672158.5620 12
@& 0.0047 0.004736 0.000312 0.002296 0.000808 0.000577 0.003174
@1Code
@2Codename
@3Layer
@4Annotation1
@4Annotation2
@4Annotation3
@4Annotation4 / Seismic Record
@+000309 4264343.8693 725161.2613 4672155.0411
@-000001 -3.9942 0.7603 3.5209
@= 0.0047 0.004736 0.000312 0.002296 0.000808 0.000577 0.003174
@: 1.4300 0.4410
@; 1.0230 0.4410
@* 03/10/96 08,58,38
@#000001 Dach 4263869.0606 722511.3280 4673009.6226 12
@& 0.0034 0.267134 0.028615 0.161739 0.019351 0.011188 0.130356
@+000213 4264664.3021 722228.4234 4672307.2491
@-000001 Dach -795.2415 282.9046 702.3735
@= 0.0034 0.267134 0.028615 0.161739 0.019351 0.011188 0.130356
@: 1.4300 0.4410
@; 1.1320 0.4410
@* 03/10/96 09,15,38
```

Note:

- Each point contains at least the line with the coordinate and variance-covariance information. In addition, more information like attributes can be attached with additional lines in between. These lines have to follow immediately the first line of the point and coordinate information.

Keywords are used to identify the type of information contained in each line. The following additional keywords are used in the baseline vector format only:

<u>Keyword</u>	<u>Information type</u>
@+	Individual baseline information (Reference point of baseline and its coordinates)
@-	Baseline vector components
@=	Variance-covariance information for baseline vector
@:	Reference antenna height and offset
@;	Rover antenna height and offset
@*	Date and time of first common epoch
@E	Error Ellipse (relative). <p>Note: In the SKI ASCII Point Coordinate format the error ellipses records accompany the point info and refer to absolute error ellipses. Here they accompany the baseline info and therefor refer to relative error ellipses.</p>

SKI ASCII Export Settings

The SKI ASCII Export Settings consist of three property-pages. If you select the File Type Baselines the Coordinate System page will change to Baseline.

General:

File Type:

Select between **Points** and **Baselines**.

Coord. Type:

Select between **WGS84** and **Local**
Select between **Cartesian**, **Geodetic** and **Grid**.

Height Mode:

Select between **Orthometric** and **Ellipsoidal** height.

Sort by:

Select to sort the point list by **Point Id** or by **Time**.

Rounding:

Select the number of decimals to which all linear values shall be rounded.

Include:

If you want to include **Keywords** and/or **Headers** to the file, check the corresponding checkbox.

To enhance the flexibility of exporting point information you are also given the option to include or omit deactivated points from export. The system default is that this option is checked for all formats except for the NGS G-file format.

If this option is de-selected when exporting points and/ or baselines:

- points which are not active will not be exported
- baselines which include one or even two inactive points will not be exported.

Note: [Filters](#) may be used as a neat alternative to activating/ de-activating points manually.

Point:

Point Type:

Manual only - Only manually occupied points will be exported.
Automatic only - Only automatically recorded points will be exported.
All - All points will be exported.

Check boxes

Select the information to be included in the file.

For a complete description of the additional point information that can be selected see: [SKI ASCII Point Coordinate Format](#).

If **Points** was selected as a **File type** in the General page, you can select to include the **Moving epochs** of kinematic GPS tracks.

Classes:

Coordinate class:

Select the [Coordinate Class](#) to be exported:

Select **Main** to export only the coordinate triplet with the highest active class for each point.
Select **Current** to export the coordinate triplets that are currently active. This might be useful if the coordinate class of individual points has been manually changed.
Select **Manual** to select one or more specified coordinate classes from the checkboxes below. Only the coordinate triplets of the selected classes will be output.

Select **All** to export all coordinate triplets of each point irrespective of its class.

Note: If you have performed a network adjustment involving Control points *Fixed in position* or *Fixed in height*, it is recommended that you export the Adjusted class to obtain the best set of consistent coordinates. This procedure ensures that the unused coordinate elements of the Control points are ignored.

Coordinate System:

This page only appears if the **File Type** in the property-page *General* is set to **Points**.

Name:

Select a Coordinate System from the list and modify the properties if desired. A Coordinate System allows you to export coordinates in a different format as stored in the database. For more information refer to:

[Coordinate System](#)

Note: The Coordinate System of the selected Project is selected per default.

Baseline:

This page only appears if the **File Type** in the property-page *General* is set to **Baselines**.

Baseline Type:

Select the type of baseline being it:

- **Static only:** only those baselines of static intervals
- **Moving only:** only those baselines of moving tracks
- **All:** all baselines

Check boxes

For a complete description of the additional baseline information that can be selected see: [SKI ASCII Baseline Vector format](#)

User-defined ASCII File Export

The user defined ASCII Export allows points to be extracted from Projects to ASCII files.



1. From the **Export** menu select **ASCII...**, or press  (Export ASCII Data) in the **Tools** List Bar.
2. If no Project is active select one from the list and click **Export**.
3. From the list **Save as type** select one of the following types:
 - Text File (Tab delimited) (*.txt)
 - Formatted Text (Space delimited) (*.prn)
 - CSV (Comma delimited) (*.csv)
 - Semi-colon delimited (*.ssv)

Note: The difference between these file formats is the delimiter only.
4. From the browser select the desired directory.
5. Enter a **File name** without extension.

Note: The file extension will be added automatically depending on the selected file type.
6. Modify the **Settings** if desired.

Note: You can give a new name to the modified settings and add them to the list.
7. Press **Save** to write the file or **Cancel** to abort the function.

Select from the list below to learn more about User-defined ASCII Export Settings:

[User-defined Export Settings](#)

[Add User-defined Export Template](#)

[Delete User-defined Export Template](#)

[Save User-defined Export Template as a File \(*.ues\)](#)

[Load User-defined Export Template from a File \(*.ues\)](#)

User-defined Export Settings

The User-defined Export Settings consist of the following property-pages.

General:

Points:

Check to export Points

Free Codes:

Check to export Free Codes.

Note: This option is only available if the points are sorted by time.

Field Notes:

Check to export Field Notes.

Note: This option is only available if the points are sorted by time.

Header Footer:

Check to export the Header and Footer defined in the property page **Header/Footer**

Column Headings:

Check to export the column headings

Deactivated Points:

To enhance the flexibility of exporting point information you are also given the option to include or omit deactivated points from export. The system default is that this option is checked for all formats except for the NGS G-file format.

If this option is deselected when exporting points and/ or baselines:

- points which are not active will not be exported.
- baselines which include one or even two inactive points will not be exported.

Note: **Filters** may be used as a neat alternative to activating/ de-activating points manually.

Include Keywords:

Check to add Keyword to the records Point, Free Code and/or Field Note. Define the Keywords in the appropriate text boxes below.

Coord. Type:

Select between **WGS84** and **Local**

Select between **Cartesian**, **Geodetic** and **Grid**.

Height Mode:

Select between **Orthometric** and **Ellipsoidal** height.

Sort by:

Select to sort the point list by **Point Id** or by **Time**.

Rounding:

Select the number of decimals to which all linear values shall be rounded.

Point:

This page only appears if **Points** in the property-page *General* is checked.

Attributes:

Select how to display the Attributes. Change between:

Combine all

One per Column and select the number of attributes
Separate Values and select the number of attributes

Annotations:

Select how to display the Annotations. Change between:
Combine all
One per Column and select the number of annotations.

Point Type:

Manual only - Only manually occupied points will be exported.
Automatic only - Only automatically recorded points will be exported.
All - All points will be exported.

Coord Quality:

Select how to display the coordinate quality. Change between:
Standard deviation (Std. Deviation)
 Elements of **Covariance Matrix** (sigma 0, q11, q12, q13, q21, q22, q23)
Quality Indicator (Pos., Hgt., Pos. + Hgt.).

List box:

Select individual items from the list box on the left hand side and press  to add the item(s) to the list box on the right hand side. The items will be exported in the same order as they appear in the list on the right hand side.

Press  to add all items at once.

Press  to remove selected item(s) from the list.

Classes:**Coordinate class:**

Select the **Coordinate Class** to be exported:

Select **Main** to export only the coordinate triplet with the highest active class for each point.
 Select **Current** to export the coordinate triplets that are currently active. This might be useful if the coordinate class of individual points has been manually changed.
 Select **Manual** to select one or more specified coordinate classes from the checkboxes below. Only the coordinate triplets of the selected classes will be output.
 Select **All** to export all coordinate triplets of each point irrespective of its class.

Note: If you have performed a network adjustment involving Control points *Fixed in position* or *Fixed in height*, it is recommended that you export the Adjusted class to obtain the best set of consistent coordinates. This procedure ensures that the unused coordinate elements of the Control points are ignored.

Free Codes

This page only appears if **Free Codes** in the property-page *General* is checked. Free codes are only available if the points are time sorted.

Infos:

Select how to display the Infos. Change between:
Combine all
One per Column and select the number of attributes
Separate Values and select the number of attributes

List box:

Select individual items from the list box on the left hand side and press  to add the item(s) to the list box on the right hand side. The items will be exported in the same order as they appear in the list on the

right hand side.

Press  to add all items at once.

Press  to remove selected item(s) from the list.

Header/Footer

This page only appears if **Header/Footer** in the property-page *General* is checked.

Header:

Enter the header information. The header information will be written to the first line(s) of the file.

Footer:

Enter the footer information. The footer information will be written at the end of the file.

Coordinate System:

Name:

Select a Coordinate System from the list and modify the properties if desired. A Coordinate System allows you to export coordinates in a different format as stored in the database. For more information refer to: [Coordinate System](#)

Note: The Coordinate System of the selected Project is selected per default.

Select from the index to learn more about User-defined ASCII Export Settings:

[Add new Settings template to the list](#)

[Delete Settings template from the list](#)

[Save Setting template as a File \(*.ues\)](#)

[Add Settings template from a File \(*.ues\)](#)

ASCII Export Settings: Classes

In this dialog page you may select the **Coordinate Classes** to be exported.

Coordinate class:

Select **Main** to export only the coordinate triplet with the highest active class for each point.

Select **Current** to export the coordinate triplets that are currently active. This might be useful if the coordinate class of individual points has been manually changed.

Select **Manual** to select one or more specified coordinate classes from the checkboxes below. Only the coordinate triplets of the selected classes will be output.

Select **All** to export all coordinate triplets of each point irrespective of its class.

Note: If you have performed a network adjustment involving Control points *Fixed in position* or *Fixed in height*, it is recommended that you export the *Adjusted* class to obtain the best set of consistent coordinates. This procedure ensures that the unused coordinate elements of the Control points are ignored.

User-defined Export Templates

Add User-defined Export Template

1. Right-click on the **Settings** drop-down list and select **New**.
2. Enter a **name** for the Settings Template.
3. Click the **Settings** button to define the template for user-defined ASCII Export.
4. Confirm with **Enter** or cancel with **ESC**.

See also:

[Save User-defined Export Template as a File](#)

[Delete User-defined Export Template](#)

Delete User-defined Export Template

1. Select the Template to delete from the **Settings** list-box.
2. Right-click on the **Settings** drop-down list and select **Delete** or **Delete All**.

Note:

- The Settings Template *Default* can not be deleted.

Save User-defined Export Template to a File

This function allows you to save User-defined Export Templates to a file.

1. Select a Template from the **Settings** list-box.
2. Right-click on the **Settings** list-box and select **Save As...**
3. From the browser select the desired directory.
4. Enter a **File name** without extension.
5. Click **Save** to confirm or **Cancel** to abort the function. A file with the extension “ues” will be stored.

Note:

- The Export Template file (*.ues) can be transferred to another computer to import into another Office database. See also: [Load user-defined Export Template from a File](#).

Load User-defined Export Template from a File

This function allows you to load User-defined Export Templates that have been created with another LGO installation via [Save User-defined Export Template to a File](#). Copy the file on to your harddisk and proceed as follows:

1. Right-click on the **Settings** list-box and select **Load...**
2. From the browser select the desired file.
3. Click **Open** to confirm or **Cancel** to abort the function. The new Template will be added to the **Settings** list.

Note:

- Change **Files of type** to **All files (*.*)** if the template file does not have the extension *ues*.

NGS B- and G-file Export

NGS B- and G-file Export allows points and vectors to be extracted from Projects to an NGS B- and G-file. These files are part of the Blue Book output, which for certain projects in the USA is required by the NGS (**N**ational **G**eodetic **S**urvey).

For a detailed format description refer to the following publication by the NOAA: *Guidelines for submitting GPS relative positioning data to the National Geodetic Survey, Rockville MD, Version 1.3 (March 1988)*.

http://www.ngs.noaa.gov/FGCS/BlueBook/pdf/Annex_L.pdf

Detailed information regarding the format of the files and requirements can also be found on the NGS website:

<http://www.ngs.noaa.gov/FGCS/BlueBook/>

LGO is able to create the following files required for submission to the NGS:

- B-File - GPS Project and Station Occupation Data File.
- G-File - GPS Vector Solutions - Global Positioning System Data Transfer Format.



1. From the **Export** menu select **ASCII...**, or press  (Export ASCII Data) in the **Tools** List Bar.
2. If no Project is active select one from the list and click **Export**.
3. Select **Save as type**: NGS B- and G-file (*.gfl, *.bfl).
4. From the browser select the desired directory.
5. Enter a **File name** without extension.
Note: The file extensions will be added automatically (*.gfl, *.bfl)
6. Press **Settings** to define the **NGS File Export Settings**.
7. Press **Save** to write the file or **Cancel** to abort the function.

Note:

- LGO will automatically generate the **complete** G-File, and will **View/Edit** (if user chooses to) the B-File manager for the user to completely enter all information required by the NGS. LGO will not actually create the final B-File until all information necessary to complete the B-File is entered or validated by the user. Should the user not choose to **View/Edit** the B-File, an intermediate file with the extension *.bfl1 will be created. In such a case, the user can edit the necessary components of the B-File using the B-File Manager outside the LGO environment. The **B-File Manager** is automatically installed with LGO, and can be accessed from the Start/Programs/LGO Menu.

Important:

- The NGS B-File and G-File Export tool requires that all processing of vectors and necessary quality control checks have been completed prior to launching the NGS B-File and G-File Export tool. The user cannot add or append station, session or vector information once the B-File and G-File are created. In addition, the tool will export **all** vectors and points contained in the project. Any point or session information not required in the B-File and G-File must be deleted prior to initiating the B-File and G-File Export tool.

Related Topics:

B-File Manager

Header

Stations

Antennas

Receivers

Sessions

NGS B- and G-file Export Settings

[Example:](#)

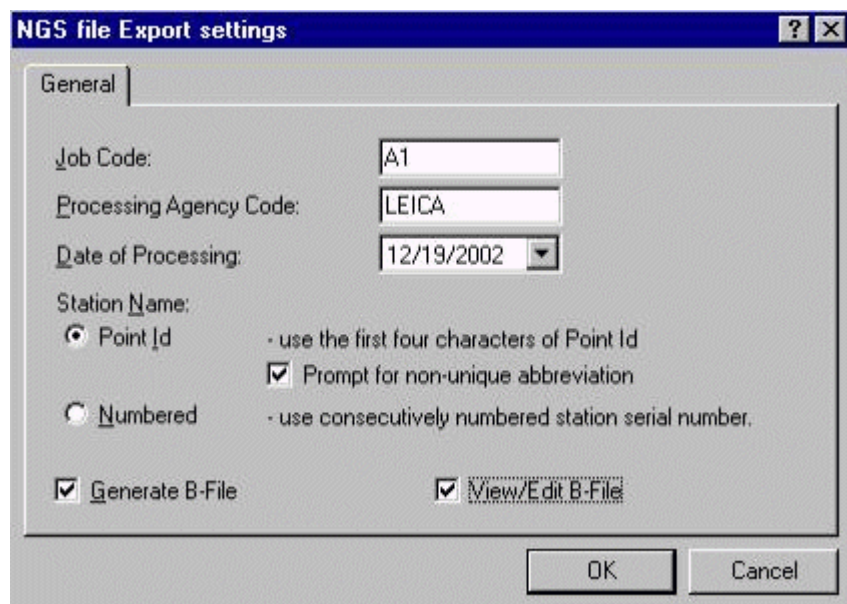

1. Enter the **Job Code** and **Processing agency**.
2. Choose the method of defining **Station Names**:
 - **Point ID** (with non-uniqueness prompt)
 - **Numbered**
3. Choose to **Generate B-File**.
4. Choose to **View/Edit B-File** immediately after creation.

Job Code:

Enter the Job Code. The NGS document describes the Job Code [as follows](#):

“A two-character alphanumeric job code must be assigned to each horizontal control job submitted by an organization. The job code, along with the data set type, the name of the submitting agency, and the data set creation date will serve to uniquely identify each data set received by NGS. The first character of the two-character job code must always be a letter; the second character may be either a letter or a number (1 through 9). The preferred method of assigning job codes is to begin with AI and end with ZZ, i.e., AI, A2, ..., A9, BI, ..., ZI, ..., Z9, AA, AB, ..., ZZ. This allows for a total of 910 uniquely identified horizontal control jobs to be submitted by any one organization. Should this sequence be exhausted, the job codes may then be assigned again from the beginning - AI, A2, etc.”

For more information please see:

<http://www.ngs.noaa.gov/FGCS/BlueBook/pdf/horizontal.pdf>

(Relevant page 1-1)

Processing Agency Code:

Enter the code of your Processing Agency.

The Processing Agencies are the organizations which have contributed (or are expected to contribute) data resulting from geodetic control established to extend and/or densify the national horizontal and vertical geodetic control networks. The unique processing agency code is required to be registered with the NGS prior to generating these reports.

For more information please see:

<http://www.ngs.noaa.gov/FGCS/BlueBook/annexc/annexc.index.html>

Date of Processing:

Enter the date when the data has been processed. The default date will correspond to the system date of your computer. The user has the opportunity to modify the processing date of the project.

Station name:

The NGS requires points to be referenced with a unique 4 character Station Name. Two choices are available to the user to automatically generate the unique 4 character Station Name:

- **Point Id:** Will use the first 4 characters from the supplied point ID used when the user collected and/or processed the project. The user has a choice to have LGO prompt if creating the Station Name results in a non-unique abbreviated Station Name.
- **Numbered:** LGO will automatically create unique 4 character number for each Station Name starting the numbering sequence at 0001.

Generate B-File:

The user has the option of generating just the G-File or both the B-File and G-File. If you do not require the B-File to be created it is not necessary to check this option.

If you select to generate the NGS B-file the option **View/Edit B-File** becomes active. Tick this option to interactively modify the output while the NGS B-file is written.

Note: The B-File cannot be completed until the user has entered all data pertaining to the project. An intermediate file with the *.bf1 extension will be created if all data required has not been entered. This *.bf1 file can be edited and completed outside the LGO environment with the installed B-File Manager.

View/ Edit B-File:

To immediately have the opportunity to edit and complete the B-File, the user can check this option.

Click **OK** to confirm your settings or **Cancel** to abort the function.

Note:

- **Job Code** and **Processing Agency** are displayed in the **NGS B- and G-file Export** dialog as entered in the **NGS file Export settings** dialog.

See also:

B-File Manager

Custom ASCII File Export

Custom ASCII File Export allows points to be extracted from projects to an ASCII file by using a format template file.

Format template files can be created with the Leica Format Manager program. The Format Manager program is installed automatically during the LGO installation.

Note:

- For more information about the Format Manager program please refer to the appropriate Online-Help.



1. From the **Export** menu select **ASCII...**, or press  (Export ASCII Data) in the **Tools** the List Bar.
2. If no Project is active select one from the list and click **Export**.
3. Select **Save as type**: Custom ASCII file (*.cst)
4. From the browser select the desired directory.
5. Enter a **File name** without extension.
Note: The file extension will be added automatically (*.cst)
6. Modify the **Settings**.
7. Press **Save** to write the file or **Cancel** to abort the function.

Related Topics:

[Custom ASCII Export Settings](#)

Custom ASCII Export Settings

The Custom ASCII Export Settings consist of the following property-pages.

General:

Point Type:

All - All points will be exported.

Manual only - Only manually occupied points will be exported.

Automatic only - Only automatically recorded points will be exported.

Baseline Type:

Static only - Only those baselines of static intervals

Moving only - Only those baselines of moving tracks

All - All baselines

Sort by:

Select to sort the point list by **Point Id** or by **Time**.

Setup Measurements:

Select whether Setup measurements like, e.g. *Horizontal Angle*, *Vertical Angle* or *Slope Distance* shall be exported to all Data Blocks, in which the corresponding variables are available in the selected Format template, or just to the *TPS Setup* Data Blocks.

All Blocks - Setup measurements will be exported to all Blocks.

Setup Only - Setup measurements will be exported only to the *TPS Setup* Data Blocks in the template.

Sets of Angles Measurements

Select whether all observations included in a Sets of Angles application shall be exported to all Data Blocks or just the calculation results to the *Sets of Angles* Data Block.

All Blocks - All observations included in a Sets of Angles application will be exported to the *TPS Station* and the *TPS Measurements* Blocks.

Sets of Angles Only - All observations connected to a station setup for which a Sets of Angles application exists are skipped in the *TPS Station* and the *TPS Measurements* Blocks.

The Sets of Angles results can be exported to the *Sets of Angles* Block independently of this setting.

Format Template:

Click the browser  to select the Format Manager template file (*.frt).

Tip: If you have not yet defined the template file, right-click on the Format Template box and select **Execute Format Manager...** to start up the program and define the template.

Executable File:

Tick the checkbox if you wish to call an executable file (*.exe) or a batch file (*.bat) automatically after

the ASCII file has been created. Click the  button to browse for an executable or for a batch file. This file will then be called with the filename of the newly created ASCII file (including the full path) as the first parameter.

This functionality may be useful to automatically invoke an additional conversion of the ASCII file.

Include:

To enhance the flexibility of exporting point information you are also given the option to include or omit deactivated points from export. The system default is that this option is checked for all formats except for the NGS G-file format.

If this option is deselected when exporting points and/ or baselines:

- points which are not active will not be exported.

- baselines which include one or even two inactive points will not be exported.

Note: [Filters](#) may be used as a neat alternative to activating/ de-activating points manually.

Classes:

Coordinate class:

Select the [Coordinate Class](#) to be exported:

Select **Main** to export only the coordinate triplet with the highest active class for each point.

Select **Current** to export the coordinate triplets that are currently active. This might be useful if the coordinate class of individual points has been manually changed.

Select **Manual** to select one or more specified coordinate classes from the checkboxes below. Only the coordinate triplets of the selected classes will be output.

Select **All** to export all coordinate triplets of each point irrespective of its class.

Note: If you have performed a network adjustment involving Control points *Fixed in position* or *Fixed in height*, it is recommended that you export the Adjusted class to obtain the best set of consistent coordinates. This procedure ensures that the unused coordinate elements of the Control points are ignored.

Coordinate System:

Name:

Select a Coordinate System from the list and modify the properties if desired. A Coordinate System allows you to export coordinates in a different format as stored in the database. For more information refer to:

[Coordinate System](#)

Note: The Coordinate System of the selected Project is selected per default.

FBK Files

FBK File Export

The FBK File Export allows to create a Field Book File for AutoDesk™ Land DeskTop.



1. From the **Export** menu select **FBK data...**, or press  (Export FBK file) in the **Tools** List Bar.
2. If no Project is active select one from the list and click **Export**.
3. From the browser select the directory into which the FBK file shall be saved.
4. Enter a **File name** without extension. The extension *.fbk will be added automatically.
5. Click the **Settings** button and decide whether and how you wish to include the export of lines and areas.
6. Press **Save** to write the file or **Cancel** to abort the function.

Note:

- For GPS data the FBK file contains the Reference station coordinates and antenna heights as well as the measured coordinates of the rover points. For TPS data the FBK file contains instrument and setup information as comments followed by station coordinates, instrument heights and TPS observations (including the reflector heights).
- If a line in the FBK file starts with an exclamation mark character, the information will be treated as a comment when importing the file into AutoDesk™ Land DeskTop.
- The coordinates must be available in a *Local Grid* coordinate system. They can either be stored as *Local Grid* or a Coordinate System defining local grid coordinates must be attached to the Project (in case of GPS observations).
- If **Use alpha point ID** is **set** alphanumeric Point Ids will be preserved; **if not** alphanumeric point numbers will be replaced by numeric point numbers and the original point number is exported as a comment.

FBK File Export Settings

The FBK File Export Settings consist of the following property-page.

General:

Use alpha point ID

Check this option if you want to export Point Ids containing alpha characters without being converted to Point Ids containing purely numeric characters. If this option is checked the all Point Ids will be written in between quotation marks in the FBK file.

Export lines and areas

Check this option if you want to include the export of Lines and Areas into the FBK File Export. If this option is checked you may further decide which **FBK figure Id** shall be used to identify the Line or Area in the FBK file.

FBK figure Id:

This option is only available if the **Export lines and areas** option is active.

To identify the line or area in the FBK file you may choose between the following options from the combo box:

- **Point Code Only:** Select this option if you want the line/ area to be identified by the code of the first point in the line/ area. If there is no Point Code available the Line/ Area Id will be taken instead.
- **Point Code + Line ID:** Select this option if you want the line/ area to be identified by the code of the first point in the line/ area **and** by the Line Id.
- **Line ID Only:** Select this option if you want the line/ area to be identified by the Line Id.
- **Line Code + Line ID:** Select this option if you want the line/ area to be identified by the code of the line **and** by the Line Id.

Include:

To enhance the flexibility of exporting point information you are also given the option to include or omit deactivated points from export. By default this option is checked.

If this option is de-selected points which are not active will not be exported.

GIS/CAD

GIS / CAD file Export

The GIS/ CAD Export is an optional component and allows points, lines and areas (incl. thematical codes) to be extracted from Projects to DXF or AutoCAD™ DWG files or to MicroStation™ DGN files. DXF or DGN formatted files can be imported by many GIS or CAD software packages.

Codelist Lookup-Tables can be defined allowing you to translate Thematical Codes into AutoCAD™ Layers and Blocks or MicroStation™ Levels and Cells.

Note:

- The coordinates must be available in a *Local Grid* coordinate system. They can either be stored as *Local Grid* or a Coordinate System defining local grid coordinates must be attached to the Project (in case of GPS observations).

How to export Projects to DXF or AutoCAD™ DWG files or to MicroStation™ DGN files:

1. From the **Export** menu select **GIS/CAD...**, or press  (Export GIS/CAD Data) in the **Tools** List Bar.
2. If no Project is active select one from the list and click **Export**.
3. From the **Save as type** combo box select the type of file you need. This may be either *AutoCAD Files* or *MicroStation Files*.
4. From the browser select the desired directory.
5. Enter a **File name** without extension.
Note: The file extension (*.dxf, *.dwg or *.dgn) will be added automatically.
6. Select a **Lookup** table from the list or **add a new Lookup-Table**. To modify the selected Lookup table click on **Lookup**.
7. Modify the **Settings** if desired.
Note: Only if a **Lookup Table** has been specified, does the **Settings**-button become active.
8. Press **Save** to write the file or **Cancel** to abort the function.

Related topics:

[Settings](#)

[Lookup Table](#)

[Add a new Lookup-Table](#)

[Modify a Lookup-Table](#)

[Delete a Lookup-Table](#)

GIS / CAD Export Settings

The GIS/CAD Export Settings consist of the following property-pages.

General:

Coord. Class:

Select an individual **Coordinate Class**. Only the coordinate triplets of the selected class will be output. Select **All** to export all coordinate triplets of each point irrespective of its class. Select **Main** to export only the coordinate triplet with the highest active class for each point. Select **Current** to export the coordinate triplets that are currently active. This might be useful if the coordinate class of individual points has been manually changed.

Note: If you have performed a network adjustment involving Control points *Fixed in position* or *Fixed in height*, it is recommended that you export the Adjusted class to obtain the best set of consistent coordinates. This procedure ensures that the unused coordinate elements of the Control points are ignored.

Coord. Type:

Select **Local** and then **Grid** if not already selected.

Height Mode:

Select either **ellipsoidal** or **orthometric** from the combo box.

Point Type:

Manual only - Only manually occupied points will be exported.
Automatic only - Only automatically recorded points will be exported.
All - All points will be exported.

Include:

To enhance the flexibility of exporting point information you are also given the option to include or omit deactivated points from export. The system default is that this option is checked for all formats.

If this option is deselected when exporting points and/ or baselines:

- points which are not active will not be exported.
- baselines which include one or even two inactive points will not be exported.

Note: **Filters** may be used as a neat alternative to activating/ de-activating points manually.

Coord. order:

From this combo box you can select whether Easting **or** Northing shall be the first coordinate to be exported.

Coord. switch:

Easting/ Northing: Click one or both of these checkboxes if you want to have the Easting-axis pointing to the West and/ or the Northing-axis pointing to the South in your *.dxf or *.dwg or *.dgn file.

Coordinate System:

Name:

Select a Coordinate System from the list and modify the properties if desired. A Coordinate System allows you to export coordinates in a different format as stored in the database. For more information refer to: [Coordinate System](#)

Note: The Coordinate System of the selected Project is selected per default.

AutoCAD/ Micro Station:

Depending upon the type of file you selected on the main sheet, the tab of the **third** property page will either be labelled *AutoCAD* or *MicroStation*. For detailed information see:

GIS / CAD Export Settings: AutoCAD, MicroStation

GIS / CAD Export Settings: AutoCAD, MicroStation

AutoCAD:

AutoCAD Release Version:

Select an AutoCAD version from the list. Select between AutoCAD version 2000, 2004 or 2007.

Format:

Select between **DXF** (ASCII Data eXchange Format) or **DWG** (binary AutoCAD format)

Coordinate Type:

Enables you to switch between exporting 2 dimensional and 3 dimensional coordinates.

Export objects as polylines

In LGO Line and/ or Area objects may contain arcs or spline elements. When coordinates of **Coordinate type 2D** are used, select this option to ensure that in AutoCAD such an object is recognized as one (and not as a sequence of separate elements consisting of either straights or arcs or splines).

Note that **3D** objects will always be exported as polylines because the arcs and splines are exported as straight elements.

MicroStation:

Seed File:

Browse for and select the Seed File you need.

Lookup Table

Lookup Table

The Codelist Lookup-Table enables you to associate Code Groups and thematical Codes of LGO with *Layers* and *Blocks* of a **DXF** Template File or with *Levels* and *Cells* of a **DGN** Cell Library. The Lookup-Table is used as a reference during the export of a Project.

Select from the list below to learn more about Lookup-Tables:

[Add a new Lookup-Table](#)

[Modify a Lookup-Table](#)

[Delete a Lookup-Table](#)

[Save a Lookup-Table as a file](#)

[Load a Lookup-Table from a file](#)

Add a new Lookup-Table

Enables you to add a new Lookup-Table:

1. Right-click on the Lookup combo box and select **New**.
2. In the General page enter a **Lookup Table Name**.
3. Check the boxes if you want to automatically generate **Point ID** and **Elevation** attributes for all points.

Depending on the type of file you specified under 'Save as', change to the *AutoCAD* or *MicroStation* Settings page.

4. **AutoCad Settings:** Enter name and path of a **Template File** if you want to use your own DXF file containing pre-defined Layers and Blocks.

MicroStation Settings: Enter name and path of a **Cell Library, DGN library** or **DGN file** if you want to use your own DGN file containing pre-defined Levels and Cells.

5. Press **OK** to confirm or **Cancel** to abort the function.

Modify a Lookup-Table

Enables you to modify a Lookup-Table:

1. Select a Lookup-Table from the list box.
2. Click on the **Lookup...** button.
3. From the Tree-View on the left-hand side select a Code . The Code Group, Code, Type and Description of the selected Code will be listed under Leica Coding.

Depending upon the type of file you selected on the main sheet, you will be presented with edit fields for *AutoCAD* or *MicroStation* Coding:

4. Under **AutoCAD** Coding select a **Layer** and a **Block** from the list. All Layers and Blocks defined in the DXF Template File will be listed. See also [Add a new Lookup-Table](#).

Under **MicroStation** Coding select a **Level** and a **Cell** from the list. All Levels and Cells defined in the DGN Cell Library will be listed. See also [Add a new Lookup-Table](#).

5. Repeat step 3 and 4 until all Leica Codes are associated with *AutoCAD* codes or *MicroStation* Codes, respectively.
6. Press **OK** to confirm or **Cancel** to abort the function.

Line and **Area Codes** can also be selected. If you select a Line or Area Code in the left hand tree-view the style, color and thickness which the Line/ Border shall have in your *.dxf or *.dwg or *.dgn file is auto-assigned, but may be modified if necessary.

If your project contains points, lines or areas without coding and you want these to be exported, too, then proceed to the [Code Defaults](#) tab.

Note:

- If a Leica Code contains Attributes they will be translated to *AutoCAD* or *Microstation* Attributes automatically. Upon right-click on the **Foreign Attribute** you may modify it.
- Additionally the Attributes *Point Id* and *Elevation* will be used if this option has been selected during adding a new Lookup-Table. If they are not defined right-click in the Attribute window and select **Add Extra Attribute**.
- All Attributes may be **Activated** or **Deactivated** individually.

Modify a Lookup-Table: Code Defaults

If your project contains points, lines or areas without coding and you want these to be exported, too, then tick the corresponding checkbox(es) **Export Points/ Lines/ Areas without codes**.

Export Points without codes:

For points without codes you may select a **default** *AutoCAD Layer* and *Block* or, respectively, a **default** *Microstation Level* and *Cell*.

Export Lines/ Areas without codes:

For Lines or Area borders without codes you may select a **default** *Layer* or *Level* and a **default** style, color and thickness which the Lines/ Borders shall have in *AutoCAD* or *MicroStation*.

Else you may choose that lines/areas without codes shall be exported to the same *Layer* or *Level* as their individual start points.

If you select **Use Layer/ Level of Start Point** then it is not possible to select a default *Layer/ Level* at the same time. If the start point of the line/ area does not have a code then the line/ area will be exported to the default *Layer/ Level* set for the export of points without codes.

You may also choose to **Apply individual settings** for the **Line/ Border Line Style, Color** and **Thickness**. In this case the line/ border style, color and thickness of the line/ border to be exported will be taken as defined in the [Line/ Area Properties: General](#) page for that specific line. It is not possible then to select a default style, color and thickness for all lines/ border lines without codes.

Delete a Lookup-Table

Enables you to delete one or all Lookup-Tables:

1. Select a Lookup-Table from the list box.
2. Right-click on the selected Lookup-Table and select **Delete** or **Delete All**.

Load Lookup-Table from a file

This functionality allows you to load a Lookup-Table that has been created with another LGO installation via [Save Lookup-Table as a file](#). Copy the file on to your hard-disk and proceed as follows:

1. Right-click on the **Lookup Table** combo-box and select **Load...**
2. From the browser select the desired file.
3. Click **Open** to confirm or **Cancel** to abort the function. The new Lookup-Table will be added to the list of Lookup-Tables in the combo-box.

Note:

- Change **Files of type** to **All files (*.*)** if the Lookup-Table file does not have the extension **.lut*.

Save Lookup-Table as a file

This functionality allows you to save a Lookup-Table defined in LGO or Flex Office to a file.

1. Select a Lookup-Table from the **Lookup Table** combo-box.
2. Right-click into the **Lookup Table** combo-box and select **Save As....**
3. From the browser select the desired directory.
4. Enter a **File name** without extension.
5. Click **Save** to confirm or **Cancel** to abort the function. A file with the extension **.lut* will be stored.

Note:

- The Lookup-Table file can be transferred to another computer to be imported into another Office database. See also: [Load Lookup-Table from a file.](#)

Shape files

Shape File Export

Shape File Export is used to generate ESRI Shape files from points, lines and areas stored in a project. In addition to the geometrical information you can define which attribute information shall be exported to the Shape Attribute (*.dbf) file.

How to export Points, Lines and Areas to ESRI Shape files:

1. From the **Export** menu select **Shape file...**, or press  (Export shape file) in the **Tools** List Bar.
2. If no Project is active select one from the list and click **Export**.
3. From the browser select the directory into which the Shape files shall be saved.

Note: The file names are created automatically from the point, line or area code names. One set of Shape files is created for every code. Points, lines or areas without a code are exported into one set of Shape files.

4. Modify the **Settings** if desired.

Note: To add a setting to the list right-click into the **Settings** drop-down list and select **New** from the context menu. Enter a name for the settings template. To load an existing setting select it from the list of available settings.

5. Press **Save** to write the files or **Cancel** to abort the function.

To learn more about Shape file Export Settings see also:

[Shape File Export Settings](#)

Note:

- Shape files can be exported either as Geodetic Coordinates (using decimal degrees) or as Local Grid Coordinates. In case of GPS observations a coordinate system must be attached to the project to successfully export local grid coordinates.

Shape File Export Settings

The Shape File Export Settings consist of the following property-pages.

General:

Coord. Class:

Select an individual **Coordinate Class**. Only the coordinate triplets of the selected class will be output. Select **All** to export all coordinate triplets of each point irrespective of its class. Select **Main** to export only the coordinate triplet with the highest active class for each point. Select **Current** to export the coordinate triplets that are currently active. This might be useful if the coordinate class of individual points has been manually changed.

Note: If you have performed a network adjustment involving Control points *Fixed in position* or *Fixed in height*, it is recommended that you export the Adjusted class to obtain the best set of consistent coordinates. This procedure ensures that the unused coordinate elements of the Control points are ignored.

Coord. Type:

Select between **WGS84** and **Local**.
If **Local** is selected choose between **Geodetic** and **Grid**.

Height Mode:

If **Local** is selected under **Coord. Type** choose between **Orthometric** and **Ellipsoidal** height.

Dimension:

Select between **2D** (position only) and **3D** (position and height) to be exported.

Data to export:

Points, Lines and Areas data may be exported to a Shape file.

Check **Points** if you want to export point data only. Make further settings in the upcoming **Points** page. Check **Lines** and/ or **Areas** if you want to export Lines and Areas data as well. Make further settings in the upcoming **Lines** and **Areas** pages.

If in addition to **Points** also **Lines** or **Areas** are selected for export, points contained in the lines or areas will not be exported separately with the Points. If only **Points** are selected for export, **all** points will be exported.

Note: Either **Points** or **Lines** or **Areas** has to be selected. Otherwise there will be no data to be exported.

Include:

To enhance the flexibility of exporting point and/ or Lines and Areas information you are also given the option to include or omit deactivated points from export. The system default is that this option is checked.

If this option is de-selected, Points, Lines and Areas which are not active will not be exported.

Note: **Filters** may be used as a neat alternative to activating/ de-activating points manually.

Points/ Lines/ Areas:

These pages only appear if **Points**, **Lines**, **Areas** is checked in the property-page *General*.

- From the list of **LGO Attribute Names** select which attributes shall be written to the Shape files. The Point Id, Coordinates, Quality information or Date and Time can be exported in addition to the thematical information stored with a Point, Line or Area (Code group, Code name and Description, Attributes).

For Lines and Areas information such as Line/Area Id, Line styles, the actual Line length, the area etc. can be exported as well.

- Right-click in the **Shape Attribute Name** column and select **Modify...** if you want to change the name of an Attribute for the Shape files.

Note: The Attributes to the thematical codes cannot be renamed. The Attribute name used in the codelist will be taken.

Coordinate System:

Name:

Select a Coordinate System from the list and modify the properties if desired. A Coordinate System allows you to export coordinates in a different format as stored in the database. For more information refer to: [Coordinate System Properties: General](#).

Note: The Coordinate System of the selected Project is selected per default.

LandXML files

LandXML File Export

LandXML is used as a standard data transfer format that was designed to model and transfer Land Planning, Civil Engineering and Survey data between most of the major software suppliers in the Geomatics field.

More information on the LandXML format may be found on the LandXML website: <http://www.landxml.org>.

LandXML File Export is used to generate LandXML files from data contained in LGO or FlexOffice projects. The following entities can be exported (and imported):

- Points, Lines, Areas
- Thematical Codes (Point, Line, Area), Free Codes and Annotations
- Measurements (GPS vectors and TPS observations)
- Instrument Setup information (GPS and TPS)
- Traverse information
- Coordinate System information
- Geometry (Straights, Splines, Arcs)
- Surfaces

For detailed information on the entities (extensions) that have been added in order to describe data that is not available in the standard LandXML schema contact your local Leica representative.

How to export project data to a LandXML file:

1. From the **Export** menu select **LandXML file...**, or press  (Export LandXML file) in the **Tools** List Bar.
2. If no Project is active (open) select one from the list and click **Export**.
3. In the **Save LandXML file** dialog select the directory into which the LandXML file shall be saved from the browser.
4. Enter a **File name** without extension.
Note: The file extension will be added automatically (*.xml)
5. Modify the **Settings** if desired.
6. Press **Save** to write the file or **Cancel** to abort the function.

To learn more about LandXML File Export Settings see also :

[LandXML File Export Settings](#)

LandXML File Export Settings

The LandXML File Export Settings consist of the following property-page.

General:

Lines/ Areas

Check these options if you want to include definitions of **Line and/ or Area** objects into the *.xml file to be written.

TPS/ GNSS Observations

Check these options if you want to include the observations data into the *.xml file to be written.

Thematical/ Free Codes

Check these options if you want to include Coding information into the *.xml file to be written.

Annotations

Check this option if you want to include all annotations recorded on a point in the field into the *.xml file to be written.

Coordinate System Information

Check this option if you want to include information on the attached coordinate system into the *.xml file to be written.

Surfaces

Check this option if you want to include information on the **surfaces** defined in the project to be exported into the *.xml file to be written.

If the contour lines shall be exported, too, check **Contours**.

XSL transformation file:

Browse for an *.xsl file needed if you want to transform the *.xml file before storing it to the selected export path.

Note:

- Point information is always exported. If only points (without observations) are exported then the exported Point Class is always the *current* triplet. For Points with the **current** class being *Averaged* the *Measured* triplets will be exported, too.
- The **Linear** and **Angular units** will be applied as defined under **Options: Units/ Display**. But **Geodetic** coordinates and elements with reference to **Geodetic** coordinates (e.g. the values for a central meridian) are always exported in degrees.
- If a coordinate system is attached to the project, then the exported LandXML file will contain WGS 84 **and** local grid coordinates. If available **orthometric** heights will be exported.

Tools

Compute Geoid Separations

This command enables you to compute Geoid Separations for the points in a Project if a Geoid Model is defined in the Coordinate System used. It replaces the requirement for you to manually input Geoid Separations for your points.

This command is only required if your [geoid model](#) is defined by an **executable file**. If your geoid model is defined by a **geoid model field file** then the geoid separations of your project are always calculated automatically.

1. Make sure a Geoid Model is defined in the Coordinate System attached to your Project.
2. Open the Project for which you want to compute Geoid Separations.
3. From the **Tools** menu select **Compute Geoid Separations**. A Geoid Separation will be calculated and stored for each Point.

Note:

- If the Geoid Model you are using is defined for local Grid coordinates, make sure a Coordinate System with the appropriate Map Projection is attached to your Project.
- If you are using a regional Geoid Model that is defined for a certain area only, make sure the points of the Project are located within this area.
- In View/Edit it is also possible to display contour lines of the geoid for the extents of your project. Please refer to [Graphical Settings: View](#).

Related Topic:

[Geoid Model](#)

Compute Hidden Points

This option may only be selected from the **Tools** menu, if at least one or more **Hidden Point** measurements exist in the active project. This feature allows you to force a re-calculation of all **Hidden Points** with the current auxiliary point coordinates.

Generally, this feature has to be invoked each time the coordinates of the auxiliary points are updated, e.g. due to a new average. However, for the two main ways of updating coordinates all affected **Hidden Points** will be re-calculated automatically. That is the case:

- in the **Result Manager** when storing the baselines after post-processing.
- when **storing an adjustment result** manually or automatically.

Note:

- Be aware that only once the construction points have class **Measured** or higher will attached **Hidden Points** be calculated!

Create Geoid Model field file

Geoid Models may also be used on the receiver in the field. This command enables you to create a Geoid Model field file.

Geoid models usually consist of a geoid height grid where a Geoid Separation is defined for each grid point. Depending on the extent and the grid spacing of the Geoid Model it may require considerable disk space. In order to use the Geoid Model on a GPS sensor the disk space has to be reduced and a special field file has to be created which will allow the field system to interpolate Geoid Separations.

This command enables you to extract a Geoid height grid from an existing Geoid Model for a particular area. The area boundary can be defined by a rectangle or circle and a grid spacing in meters can be selected. The file can then be uploaded to the receiver using the [Data Exchange Manager](#).

1. From the **Tools** menu select **Create Geoid Model field file...**
2. Select a Geoid Model from the list or click on **View** and [Add a New Geoid Model](#).
3. Select the **Interpolation method** which shall be used when interpolating in the Geoid Model field file. You can choose between Bi-quadratic, Bi-linear and Spline interpolation methods. Select **Default (for System 500)** if you have to create a Geoid Model field file for a System 500 instrument or for a System 1200 instrument which runs a firmware older than Version 4.0.
4. Select the method to define the limits of the Geoid Model field file. Select between **Centre & radius** and **Extents**.
5. Enter the Coordinates of the **Center point**, the **Radius** and the Grid **Spacing**
or
enter the Coordinates of the **South-west** and **North-east** corner and the Grid **Spacing**. The order of the coordinates will appear in accordance with the order set under [Tools – Options – General page](#).
6. Check the **File size**. If you wish to use the file on the System RAM it must not exceed a certain size.
Note: The maximum possible file size may vary depending on the free memory in the receivers system RAM. Refer to the Technical Reference Manual on how to free system RAM of the receiver.
7. Click on **Save**.
8. From the browser select the path where the file shall be created.
9. Enter a **File name** without extension. (Extension "gem" will be added automatically)
10. Click on **Save** to confirm.
Note: Depending on the file size, this may take a while.

Related Topic:

[Geoid Model](#)

Create CSCS Model field file

CSCS Models may also be used on the receiver in the field. This command enables you to create a CSCS Model field file.

1. From the **Tools** menu select **Create CSCS Model field file...**
2. Select a CSCS Model from the list or click on **View** and [Add a New CSCS Model](#).
3. Select the method to define the limits of the CSCS Model field file. Select between **Centre & radius** and **Extents**.
4. Enter the Coordinates of the **Center point** and the **Radius**
or
enter the Coordinates of the **South-west** and **North-east** corner. The order of the coordinates will appear in accordance with the order set under [Tools – Options – General page](#).
5. Check the **File size**. If you wish to use the file on the System RAM it must not exceed a certain size.
Note: The maximum possible file size may vary depending on the free memory in the receivers system RAM. Refer to the Technical Reference Manual on how to free system RAM of the receiver.
6. Click on **Save**.
7. From the browser select the path where the file shall be created.
8. Enter a **File name** without extension. (Extension "csc" will be added automatically)
9. Click on **Save** to confirm.
Note: Depending on the file size, this may take a while.

Related Topic:

[CSCS Models](#)

Mean Coordinates & Differences Report

To get an overview on mean coordinates and differences for the single points in your project you may invoke the **Mean Coordinates and Differences** Report.

- In the **Tools** main menu click on **Mean Coordinates & Differences** to get a report on all points in your project for which mean coordinates have been computed.

The report opens in a stand-alone window and is listed in the **Open Documents** list bar.

Stand-alone reports can be saved as HTML files or printed:

- To save a report as an HTML file right-click inside the report and select **Save As...**
- To print a report right-click inside the report and select **Print**. A **Print Preview** is also available from the context menu.
- To select the **contents** and the **format** of the report right-click and select **Properties...** from the context menu or click  in the **Reports** toolbar. For further details refer to: [Configure a Report](#).

Note:

- The mean coordinates for a single point in your project can also be viewed in its [Point Properties: Mean page](#).

When the report has been configured to display all possible sections it presents you with the following bits of information:

- Project Information
- Differences
- Quality
- Coordinates

Differences, Quality and Coordinates are listed for each point in the project which has mean coordinates.

Project Information

[Example:](#)

Project Information

Project name:	RT Sample
Date created:	04/10/2003 10:48:18
Time zone:	1h 00'
Coordinate system name:	Sample RT
Application software:	LGO 1.0
Average limit (Position):	0.0750 m
Average limit (Height):	0.0750 m
No. of Points with Avg. limit exceeded:	3

This section gives you general information on the [Project Properties](#), like the project name, creation date and time, the time zone and the attached coordinate system. The averaging limit as defined in the project properties as well as the number of points which exceed the limit are listed in this section, too.

If information has been entered in the [Dictionary](#) page of the Project Properties dialog these pieces of information will be added to this section of the report.

Point ...

[Example:](#)

Point BM1

Avg. Local Coordinates

Easting: 548998.3080 m
 Northing: 5248370.9337 m
 Ortho. Hgt: 467.4175 m
 CQ: 0.0153 m

Use	Limit exceeded	Reference Epoch	Posn. diff [m]	Hgt. diff [m]	Posn. + Hgt. diff [m]
✓		TP306 03/24/1999 14:10:23	0.0000	0.0000	0.0000
✗	⚠	B215 03/24/1999 15:27:23	0.0828	-0.0325	0.0890

For each point with mean coordinates in the project such a section is included in the report. Listed items may include:

- the average coordinates and the coordinate quality
- the differences between each set of coordinates and the mean coordinates
- the quality for each set of coordinates
- the coordinates themselves

Used is marked by ✓.

Not Used is marked by ✗.

Limit exceeded is marked by ⚠.

Coordinate Comparison Report

To get an overview on the differences between known *Control* and *Measured* coordinates for the single points in your project you may invoke the **Coordinate Comparison Report**.

1. In the **Tools** main menu click on **Coordinate Comparison**.
2. In the **Coordinate Comparison Properties** dialog select the two projects which contain the points to be compared. For identical Point Ids the *Measured* point triplets of **Project A** will be compared with the *Control* triplets of **Project B**.

If you select the same project as Project A and Project B then all points in that project having a *Control* and a *Measured* triplet will be included into the comparison.

Define values for the **Horizontal tolerance** and the **Vertical tolerance** by which the Measured point triplet(s) may differ from the *Control* triplet without being **marked** (⚠) in the report.

In addition you may decide to include or exclude the **deactivated points of Project B** in the report.

3. Press **OK** when all Properties are set for the Coordinate Comparison.

The report opens in a stand-alone window and is listed in the **Open Documents** list bar.

Stand-alone reports can be saved as HTML files or printed:

- To save a report as an HTML file right-click inside the report and select **Save As...**
- To print a report right-click inside the report and select **Print**. A **Print Preview** is also available from the context menu.
- To select the **contents** and the **format** of the report right-click and select **Properties...** from the context menu or click  in the **Reports** toolbar. For further details refer to: [Configure a Report](#).

When the report has been configured to display all possible sections it presents you with the following bits of information:

- Project Information
- Differences
- Coordinates

Differences and Coordinates are listed for each point in the project for which a comparison is possible.

Project Information

[Example:](#)

Project Information

Project name:	Project A: Traverse	Project B: Control
Created:	11/11/2005 13:55:32	11/14/2005 19:24:52
Time zone:	2h 00'	1h 00'
Coordinate system name:	utm32	WGS 1984
Application software:	LEICA Geo Office 3.0	
Horizontal tolerance	0.020 m	
Vertical tolerance	0.075 m	
No. of points with tolerance limit exceeded:	1	
No. of points without comparison:	0	

This section of the report gives you general information on the **Project Properties**, like the project name, creation date and time, the time zone and the attached coordinate system. If information has been entered in the **Dictionary** page of the Project Properties dialog these pieces of information will be added. The **Horizontal** and **Vertical tolerances** as defined in the **Coordinate Comparison Properties** dialog as well as the number of points which exceed the tolerance are listed. Additionally, the number of *Control* points for which no matching *Measured* point triplet could be found is given.

Point ...

[Example:](#)

Point 1003

Local Coordinates

Point Class	Date/Time	Easting [m]	Northing [m]	Ortho. Hgt [m]	Hor. Diff. [m]	Vert. Diff. [m]
Control	11/10/2005 07:36:50	546617.150	5250531.220	449.550		
Measured	11/10/2005 09:01:46	546617.137	5250531.198	449.507		
Difference	-	0.013	0.022	0.043	0.026	 0.043

For each *Control* point of **Project B** such a section is included in the report. Listed items may include:

- The *Control* coordinates as stored in **Project B**.
- All *Measured* point triplets as stored in **Project A**.
- The differences between the *Measured* coordinates and the *Control* coordinates.

Measured point triplets for which the tolerance is exceeded are marked by .

Internet Download

Internet Download

This tool is intended to support an automated download of different GPS data such as RINEX raw data and [Precise Ephemeris](#). YUMA almanacs for use in the [Satellite Availability](#) tool can also be downloaded. It can be selected from the main menu under **Tools**, the menu entry being called **Internet Download**. This option will always be active, no matter whether a project is open or not. Whether the site(s) shall be selected automatically or manually has to be set under [Tools - Options - Internet](#).

On the **Internet download** sheet you will find the following three pages:

[Internet download: General](#)

[Internet download: Site logfile](#)

[Internet download: Add/ Edit custom sites](#)

Tip:

- If you are currently working on a project and decide to invoke the **Internet Download** tool, then you may do so with holding the *Shift* or *Ctrl*-key pressed. The system will switch to **Automatic** site selection, regardless of your previous settings under [Tools - Options - Internet](#). The centre coordinates of the active project will be taken as the centre coordinates for the site location. As the date for download the project's date will be taken. If your measurements comprise more than one day a "centre"-time will be determined.

This functionality may be used as a shortcut to download Precise Ephemeris for a project you are actively working on.

Alternatively:

Precise ephemeris can also be downloaded from the IGS (International GPS Service for Geodynamics) network without the help of the **Internet Download Tool**. You have two choices: either you download them from the Internet or via FTP:

FTP:

<ftp://igsceb.jpl.nasa.gov/igsceb/product/>

Internet:

<http://igsceb.jpl.nasa.gov/igsceb/product/>

1. Download the file to your computer.
2. Continue with [How to Import Precise Ephemeris](#).

Note:

The precise ephemeris files from the IGS network are compressed. To decompress these files use the tools stored under the following Internet address:
<http://igsceb.jpl.nasa.gov/igsceb/software/compress/dos/> Alternatively, you may use WinZip to decompress these files.

Precise ephemeris files for **GLONASS** satellites can be downloaded from
<ftp://cdis.gsfc.nasa.gov/glonass/products/>

Internet Download: General

Depending on the choice you made on the [Internet settings](#) page under Tools – Options, this page will present slightly different features to you.

Manual site selection

The **site** can be selected from a pre-defined list of **Available Sites**. Its coordinates will be displayed as read-only but can be converted from Geodetic to Cartesian and vice versa by switching the **Coordinate Format**.

If the selected site requires a **user name** and **password** to download files press the  button next to the selected site and enter the required user name and password. Both will be stored internally for each site.

Automatic site selection

You will be presented with a set of sites fulfilling the criteria set on the **Internet** page under **Tools – Options**. By default the first of them will be checked for download (being the closest one!), although additional sites may be selected manually, in case you also want the data of these for further processing. The coordinates of the selected site(s) will be displayed as read-only but can be converted from Geodetic to Cartesian and vice versa. Here you have to right-click onto the header-line and set the **coordinate type** you prefer.

Site update: To update the available site list press the corresponding button  in the bottom left-hand corner of the page. The automatic update of your current site list will be started via accessing the Leica FTP site.

Note:

- Updating the site index is typically only required once or twice a year. Activate this process if, for example, you are no longer able to connect to a site where you previously could. Be aware that the update process may take up to several minutes to be completed.

Independent of whether you chose **manual** or **automatic** site selection, the **Date for download** has to be selected, that is the date of the day your measurements took place. With **Precise Ephemeris** remember that it lasts up to 7 to 14 days until they are calculated for a special day and may not be available if you try to download them too early.

With [Custom Internet Sites](#) you may decide to include the parameter %H in the Site URL string to the effect that on the **General** page you may select the **date and time** (hours per day) to be downloaded.

The **Download contents** may be selected from a pre-defined list as well. You may choose between:

- Observation file, navigation file and precise ephemeris
- Observation file and precise ephemeris
- Observation file and navigation file
- Observation file only
- Precise ephemeris only
- Rapid orbits only
- YUMA almanacs only

After selecting the **download directory**, you may press the **Download**-button to start the download of the selected site(s) and contents. The Internet browser will automatically be launched, the report view on the bottom of the page will be filled and the download contents saved to the specified directory.

After the download is complete you can press the **Import** button to import the downloaded data. RINEX files can be imported into projects, Precise Ephemeris files can be imported into the [Precise Ephemeris Management](#) and YUMA almanacs can be imported into the [Satellite Availability](#) tool.

Note:

- Most RINEX observation files are stored in the compact "Hatanaka" format on the Internet. For use in LGO such files are automatically de-compressed and unzipped during Internet Download.

For further information on the "Hatanaka" format see:

ftp://igscb.jpl.nasa.gov/igscb/software/rnxcmp_2.4.0/docs/crinex.txt

Internet Download: Site logfile

By selecting the **Site Logfile** tab you will be presented with a logfile on the selected site containing information such as:

- Form
- Site identification
- Site location
- GPS receiver
- GPS antenna
- Local site ties
- Frequency standard
- Collocation
- Meteorological instrumentation
- Other instrumentation and the responsible Agency

Internet Download: Add/ Edit custom sites

On this page all existing “custom” sites are available for viewing and editing via the **Custom Site Name** selection field. Custom sites are user-entered sites. Initially, there are none defined.

Add custom sites:

With the **Add**-functionality you are given the chance to **add** a completely new “custom” site to the existing list of available sites which show up on the [General](#) page. This may become useful to you as soon as different agencies start offering their own RINEX raw data or [Precise Ephemeris](#).

Enter the **Custom Site Name**, a **Site Abbreviation** (max. 4 characters) and the **coordinates** of the site.

If the site requires a **user name** and **password** to download files press the  button next to the site name and enter the required user name and password. Both will be stored internally for each site.

Once a custom site is defined the **Add**-button will become active. A site is fully defined when its **coordinates** have been entered and a valid **Site URL** has been specified.

For example: If you wanted to add the NGS site manually and achieve an FTP-structure similar to:

<ftp://ftp.ngs.noaa.gov/cors/rinex/98049/ais1/ais1049.98o.gz>,

with ‘98’ being a flexible choice and referring to the year and ‘049’ being a flexible choice, too, and referring to the day of year, then you would have to enter the following string under **Site URL**:

<ftp://ftp.ngs.noaa.gov/cors/rinex/%y%3j/ais1/ais1%3j0.%yo.gz>

In this **%3j** stands as the representative for a three-digit *[width]* **Day of Year** specification, with the year itself and the day of year being taken from the date specification on the [General](#) page (**date for download**).

Note: If you include the parameter **%H** in the Site URL string, you will be able to set the hours per day to be downloaded on the [General](#) page.

Selecting **Add**, adds such a completely new site definition, with the requirement being that the site name be unique.

From now on the site you defined will be in the list for automatic and manual site selection.

Edit custom sites:

With this functionality you are offered the chance to edit custom sites you defined before. If an existing site is edited the **Update**-button becomes active. Selecting **Update** stores the changes to the existing definition. It is also possible to **delete** a site from the existing custom site list. It is not possible to delete one of the default sites.

If you want to have a **Site Logfile** to be presented with the custom site on the [Site Logfile page](#) in the future, the location of an existing logfile has to be specified manually. The automatic download of the logfile associated with a custom site will not be supported, which implies that you have to download and store the logfile independently on your hard disk if you require it.

Importing after Internet Download

When the download is completed the downloaded files may directly be imported into a project.

- If only RINEX files have been checked, then upon pressing the **Import**-button the standard **Assign dialog** will be invoked, just as if **Import RINEX** would have been chosen from the **Import Raw data dialog**.
- If only Precise Orbit information has been checked, then upon pressing the **Import**-button the precise ephemeris will be directly imported to the database, just as if **Import - Precise Ephemeris** would have been chosen from the main menu. On completion of the Import a message follows, reporting that the ephemeris have been successfully imported.
- If RINEX files **and** precise ephemeris files have been checked, then the precise ephemeris will be imported first, followed by the message as usual. With confirming that message the **Assign** dialog is invoked for the RINEX files.

Filters

Filters

With the **Filters** option you are presented with a tool to activate or de-activate points according to set criteria. Only if all active criteria are met will a point be selected. Filters may be used as a neat alternative to [activating/de-activating points manually](#).

The filters can be used for exporting groups of points by **deselecting** the ASCII export setting 'Include: Deactivated points'.

The Filter option will only be active if there is at least one point in the active project. On selecting this option you will be presented with a property sheet which contains **two** pages of filter setting options:

[General](#)

[Quality/ Time](#)

Filters: General

On this page you may determine the following global settings. Note that all of the criteria you set to be active will be logically connected with the 'AND' operator, which implies that all will be applied with respect to each other. Inactive criteria will not be taken into account.

Filter:

With this combo box you are offered the possibility to define a new filter template with the context menu. A default template will always be available to you. With a right-click into the combo box you may select 'New' from the context menu. In doing so, the field becomes editable. You may name your own templates and define the settings.

As soon as at least one user-defined template is defined you may also select **Delete** or **Delete All** from the context menu. The latter deletes all templates except the default template.

Class:

From this combo box you may select either a **specific** Point class or **All** classes. The default setting will be **All**. The classes Current and Main will not show up and cannot be selected.

Point Id range:

Here you may enter a range for the Point Id. The range is defined using a dash. Multiple ranges can be defined by separating each range by a comma. Additionally, individual point Ids may be specified.

Example:

d-h, m-n, A100, B200, TP20-9 (i.e. TP20...;TP29), TP20-90-9 (i.e. TP200... ;TP299)

Point Id pattern:

A Point Id pattern can be defined using the following wildcards:

?: Substitute for a single character

*: Substitute for one or more character positions

Multiple patterns can be defined by separating each pattern by a comma.

Example: W?00*, *11, PNT?0

Code Group:

In this combo box all the coding code groups used in the selected project will be displayed.

If there is no coding used in the project and no specified code groups already exist in the selected template, this combo box will be empty.

Since the Filter-functionality and its templates are globally available, code groups which may have been set to be active in a special template with a previous project will still be active in this template, even if these code groups are not available in the currently active project.

Code:

In this list box all the codes are displayed which are used in the project for the selected code group. You may select multiple codes for filtering. By default all codes are deselected. To include points without codes you may select the special entry *[none]*.

Since the Filter-functionality and its templates are globally available, codes which may have been set to be active in a special template with a previous project will still be active in this template, even if these codes are not available in the currently active project.

Replace current selection of active points:

With ticking this option, all points in the project which satisfy the criteria will be checked whereas all others will be de-activated.

If this option is not checked, all points which are already checked remain checked and all remaining unchecked points which satisfy the criteria will also be checked, i.e. this operation adds to the current selection.

Filters: Quality/ Time

On this page you may select quality and date/ time criteria to be used for filtering. Each criterion can be switched **on** or **off** using the associated checkbox. The quality criteria are:

- Position quality
- Height quality
- Position + Height quality

Each of these criteria has a combo box associated with it which enables you to select either '>=' or '<=' conditions.

In addition you may set a time criterion for filtering.

- Time: Select the start and end time for filtering. For each point in the project the Date/ Time of the current point triplet will be checked according to the filter criteria.

Datum / Map

Datum/Map

If the user requires final coordinate output in the coordinate system to which the GPS measurements are related (WGS84) then this optional tool is not necessary. However, in most cases it is necessary to transform the WGS84 coordinates into a local coordinate system.

The Datum / Map option provides you with a tool to determine transformation parameters necessary to perform datum transformations between two sets of coordinates. Additionally you may use this tool to compare coordinates from different Projects.

The parameters that are calculated using this option may be stored in the Coordinate System database. They can be accessed and managed using the [Coordinate System Management](#).

For more information about the different Transformation types available refer to [Notes about Transformation](#).

To start the Datum/Map component:

- From the **Tools** menu select **Datum/Map** or click on  from the **Tools** List Bar.

Select from the index to learn how to perform a transformation:

[Selection View](#)

[Match Points View](#)

[Configuration](#)

[Results View](#)

[Chart View](#)

[Notes about Transformation](#)

[Which approach to use?](#)

Notes about Transformation

The Datum Transformation is normally used to transform coordinates from WGS84 to a local system or vice versa. However it may also be used to perform a transformation between two local systems e.g. to compare the coordinates of two sets of points.

Depending on the purpose of determining transformation parameters, Datum / Map provides you with different Transformation types. The Transformation type used may be set under [Configuration: General](#).

Select from the index to learn more about the various Transformation types:

[Classical 2D](#)

[Classical 3D](#)

[One Step](#)

[Stepwise](#)

[Interpolation](#)

[Two Step](#)

Related topics:

[Which approach to use?](#)

[Minimum Requirements for Coordinates](#)

Which approach to use

This question is almost impossible to answer since the approach used will depend totally on local conditions and information.

If you wish to keep the GPS measurements totally homogenous and the information about the local map projection is available, the **Classical 3D** approach would be the most suitable.

If you are unsure of the local height information but the position information is accurate and you wish to keep the GPS measurements homogenous in position, then the **Stepwise** approach may be the most suitable.

For cases where there is no information regarding the ellipsoid and/or map projection and/or you wish to force the GPS measurements to tie in with local existing control then the **One-Step** approach may be the most suitable. Alternatively if a large number of common points are available and a more accurate approximation is required the **Interpolation** approach can be used.

The **Two-Step** approach also treats position and height information separately which allows for position only control points to be used as well. Compared to the One-Step approach, information regarding the ellipsoid and map projection has to be known. The advantage is that this approach can be used for larger areas than the One-Step.

Selection View

Selection View

In order to be able to determine transformation parameters two sets of coordinates have to be selected. These two sets are always stored in Projects. Upon starting Datum/Map the Selection View lists all available Projects in an upper and a lower Explorer-View.

System A, the upper view represents the points to be transformed.

System B, the lower view represents the control or pass points into which system A is to be transformed.

To select two sets of coordinates:

1. From the upper View select a Project as the system A.
2. From the lower View select a Project as the system B.
3. The  Match tab at the bottom of the view will be activated. Click on it to continue.

Note:

- Depending on the transformation type you are going to use the coordinates of System A and B must comply with the [Minimum Requirements for Coordinates](#).

Match View

Match View

The Match View enables you to select the common points of system A and system B that shall be used for the determination of the transformation parameters.

Prior to selecting the common points you may [configure](#) the transformation type and parameters. The transformation type is displayed in the status bar between the upper and the lower window. The default transformation type is the last used.

In case of *Interpolation*, *One Step* and *Stepwise* transformation type you may use the height component of some points and the position components of others or both components for the calculation of the transformation parameters. For more information see: [Select Point Type](#).

Select from the Index to learn more about the Match Points view:

[Configuration](#)

[Match common points](#)

[Activate/ De-activate common points](#)

[Delete common points](#)

[Select Point Type](#)

[Save as](#)

View the Results:

- To continue click on the  [Results](#) tab,  [Chart](#) tab or  [Report](#) tab at the bottom of the view.

Minimum Requirements for Coordinates

The following list provides you with the minimum requirements for coordinate system A and B, necessary to calculate transformation parameters using the different transformation types. The coordinates either have to comply with the minimum requirements or the coordinate system attached must allow to convert the coordinates to the type required. E.g. if coordinates are required in cartesian format but are available in geodetic format only, an ellipsoid must be defined allowing the system to convert to the appropriate format.

	Classical 2D	Classical 3D	One Step	Stepwise	Interpolation	Two Step
System A:	Grid (2D)	Cartesian	Cartesian + Ellipsoid	Cartesian + Ellipsoid	Cartesian + Ellipsoid	Cartesian
System B:	Grid (2D)	Cartesian	Grid	Cartesian + Ellipsoid + Projection	Grid	Grid + Ellipsoid + Projection

Note:

- **Cartesian + Ellipsoid** means that the coordinates have to be available in *Cartesian* or *Geodetic* format plus an *Ellipsoid* must be defined in the attached Coordinate System.

Additionally, when a transformation is determined it is important to state whether ellipsoidal or orthometric heights are intended to be used in the target system B. With this information being stored as part of the transformation definition (**Height mode**), the system knows in which direction the geoid separations have to be applied.

Furthermore, the number and type of matched points required depends on the selected transformation type as follows:

Type	Minimum requirements
Classical 2D	2 points with position
Classical 3D - 7 parameters	3 points with position + height
Classical 3D - 3 shifts	1 point with position + height
Classical 3D - 3 shifts + Scale Factor	2 points with position + height
Classical 3D - 3 shifts + Rotation about Z	2 points with position + height
Classical 3D - 3 shifts + Scale Factor + Rotation about Z	2 points with position + height
Classical 3D - Other combinations	If 3 unknowns or less => 1 point with position + height; If 4,5 or 6 unknowns => 2 points with position + height
One Step	1 point with position only; 1 point with height is required for the height part of the transformation to be determined.
Stepwise	2 points with position only; at least 3 points with position + height are required for the height part of the transformation to be determined.
Interpolation	3 points with position and 3 points with height (position and height information can be inferred from the same or different points)
Two Step	1 point with position only; 1 point with height is required for the height part of the transformation to be determined.

Only if these requirements are met will the **Results** tab of the Datum-and-Map tool become active and the transformation parameters can then be calculated.

Note:

- Since a One Step transformation may be calculated without any given height information on the local side the system will take the WGS84 ellipsoidal height as the local height in that case. This height will also be displayed as ellipsoidal then.
- If a Two Step transformation is calculated without any given height information on the local side the system will display the height after applying only the pre-transformation as a local height.

Match common points

Enables you to select common points of System A and System B.

1. **Click** on a point of the coordinate System A (top left).
2. **Double-click** on the corresponding point of the coordinate system B (top right). The Point Ids will be listed in the *Matched points* view below.
3. Repeat step 1 and 2 until all common points are matched.

Alternatively:

- Select **Auto Match** from the Context-Menu (right-click) or Toolbar  to automatically match all common points having the same Point Id.

See also:

[Activate/ De-activate common points](#)

[Delete common points](#)

Activate/ De-activate common points

If you want to exclude common points from the calculation of the transformation parameters, de-activate the points using the check-boxes. You need not remove the points from the list of matched points.

To include the points again tick the check-box again .

Note:

- To activate/ de-activate a series of matched points, highlight the points you want to activate/ de-activate and click on the checkbox of any of the selected points.

See also:

[Delete common points](#)

Delete common points

If you do not want to use some of the common points for the calculation of the transformation parameters (e.g. if in a first calculation run the residuals of some common point exceed your expectations) you can use this function to remove them from the list of *Matched points*.

- Right-click on a set of common points in the **Matched points** view and select **Delete**.

Alternatively:

- Select a series of common points and remove all at once.

See also:

[Activate/ De-activate common points](#)

Select Point Type of common points

In case of *Interpolation*, *One Step* and *Stepwise* you may use the height component of some points and the position components of others or both components for the calculation of the transformation parameters.

1. **Double-click** on the item in the **Point Type** column, select *Height*, *Position* or *Position + height* from the list.
2. Confirm with **Enter**.

Configuration of transformation type

This Property-Sheet enables you to set the **type of transformation**, the limits for the outlier detection and displays the Coordinate System parameters of system A and system B. Additionally, if a *Classical 3D* or a *One Step* or a *Two Step* transformation are to be calculated it allows you to hold some of the transformation parameters fixed and calculate only a subset of the full parameter set.

1. In the Tabbed-View  **Match** select **Configuration** from the Context-Menu (right-click).
2. Use the tabs to switch between the following pages:
 - General**
 - Outliers**
 - Coord. System A** (Displays the **Properties** of Coordinate System A)
 - Coord. System B** (Displays the **Properties** of Coordinate System B)
 - Parameters** (only available if either transformation type *Classical 3D* or *One Step* or *Two Step* is selected)
3. Make your changes
 - Note:** The fields with grey background may not be edited at the particular instant.
4. Press **OK** to confirm or **Cancel** to abort the function.

Configuration: General

Enables you to select the Transformation type and additional parameters.

Transformation type:

Allows to select one of the following transformation types:

Classical 2D
Classical 3D
Interpolation
One Step
Stepwise
Two Step

See also: [Which approach to use?](#)

Note: Depending on the transformation type used the coordinates of System A and B must comply with the [Minimum Requirements for Coordinates](#).

Default point type:

In case of *Interpolation*, *One Step*, *Stepwise* or *Two Step* it is possible to use the height component, the position component or both components of individual common points for the calculation. This parameter defines how the common points shall be matched by default. Select between **Height**, **Position** or **Position + height**.

Type:

Displays depending on the selected Transformation type, whether **Cartesian** or **Grid** coordinates are required for system A and system B.

Note: If a point exists with a coordinate triplet in *Grid* coordinates only and no Coordinate System with an Ellipsoid and/or Map Projection is attached to system A or B but *Cartesian* coordinates are required, this point will NOT be displayed in the Match View.

System:

In case of a *Classical 2D* transformation, the points in system A and B must be stored with **Local** coordinates. In case of a *Classical 3D* transformation system A is hardwired to **WGS84** but the points in system B may be stored either with **WGS84** coordinates or with **Local** coordinates. For the other transformation types, system A is hardwired to **WGS84** and system B is hardwired to **Local** coordinates.

Height Mode:

Enables you to switch the height mode of system B between **Ellipsoidal** and **Orthometric**.

Tip: In case of a *Classical 3D* transformation the default setting is *Ellipsoidal*. Change it to *Orthometric* if you are using a *Classical 3D* transformation to approximate the geoid. In this case the local coordinates after transformation will be flagged as *Orthometric*.

In case of the transformation type **Interpolation** the following parameters are available:

Position distortion/ Height distortion:

The distortion of system A due to interpolation can be steered by four parameters **High**, **Low**, **Medium**, and **None**. This can be done separately for position and for height.

High: System A will be maximally distorted. I.e. the geometry of system B will be preserved as much as possible; the quality of the pass point coordinates is high.

Low: System A will be slightly distorted. I.e. the quality of the pass point coordinates is low.

Medium: Lies between high and low. This parameter will be selected if the user has no information about the quality of the pass-point coordinates in system B.

None: System A will not be distorted (i.e., system A will be preserved completely). In this case system A will fit best into system B without changing the geometry of system A.

In case of the transformation type **Two-Step** the following parameter is available:

Pre-transformation:

Select a classical 3D transformation from the list, which shall be used as a pre-transformation during the **Two-Step** calculation.

Configuration: Outliers

Enables you to set the limits for outlier detection in the residuals. I.e. point residuals matching one or more of the following conditions will be indicated with an exclamation mark () in the Result View.

The limits may be set individually for **Position difference**, for **Height difference** and for **Pos.+Hgt. difference**.

You may either set all limits to **ignore** or set the first limit to **use** and connect the remaining limits with the argument **and** or the argument **or**.

Note:

- Various combinations of arguments and limits are theoretically possible. However most logical will be to set the **Position difference** to **use** and connect the others with the argument **or** and enter realistic values for the limits.

Configuration: Parameters

This page is available only if either the transformation type *Classical 3D* or *One Step* or *Two Step* is selected in the **General** page. It allows you to select whether individual transformation parameters shall be computed or hold fixed.

Transformation model:

This option is only available if transformation type *Classical 3D* is selected in the **General** page:
Select between two different transformation models: Bursa-Wolf or Molodensky-Badekas.

Number of parameters:

Select **all** to compute all parameters.

Select one of the predefined number of parameters. For the parameters that are set to **No**, a **Value** (which will be held fixed throughout the computation) can be introduced. Double-click on the parameter in the column **Value**, change the value and press Enter.

If transformation type *Classical 3D* is selected in the **General** page then you may select **manual setting** to individually configure all parameters. In the **Compute** column, double-click on a parameter, select between **Yes** and **No** and confirm with Enter. For the parameters that are set to **No**, a **Value** (which will be held fixed throughout the computation) can be introduced. Double-click on the parameter in the column **Value**, change the value and press Enter.

Height transformation:

This option is only available if either transformation type *One Step* or *Two Step* is selected in the **General** page.

Select between the computation of an **Average Plane** or an **Average Height Shift**. If **Average Height Shift** is selected then an average constant will be computed for the height transformation even if there are more than two height points available.

Classical 2D

The Classical 2D transformation approach allows you to determine parameters for transforming the position coordinates (Easting and Northing) from one grid system to another grid system. No parameters for the height will be calculated.

This transformation determines 4 parameters (2 shifts Easting and Northing, 1 Rotation and 1 Scale factor).

Note:

- The Classical 2D transformation may only be used to export local Coordinates to an ASCII file. A Classical 2D transformation can not be used in a Project.

Other transformation approaches:

[Classical 3D](#)

[One Step](#)

[Two Step](#)

[Interpolation](#)

[Stepwise](#)

[Which approach to use](#)

Classical 3D

The Classical 3D transformation approach creates transformation parameters using a rigorous 3D Classical method.

Basically, the method works by taking the Cartesian coordinates of the GPS measured points (WGS84 ellipsoid) and comparing them with the Cartesian coordinates of the local coordinates. From this, **Shifts**, **Rotations** and a **Scale factor** are calculated in order to transform from one system to another.

The Classical 3D Transformation approach allows you to determine a maximum of 7 transformation parameters (3 shifts, 3 rotations, and 1 scale factor). However the user can select the parameters to be determined.

The Classical 3D transformation allows the choice of two different transformation models: Bursa-Wolf or Molodensky-Badekas.

For the Classical 3D transformation method, we recommend that you have at least three points for which the coordinates are known in the local system and in WGS84. It is possible to compute transformation parameters using only three common points but using four produces more redundancy and allows for residuals to be calculated.

The Advantage

- The advantages of this method of calculating transformation parameters are that it maintains the accuracy of the GPS measurements and may be used over virtually any area as long as the local coordinates (including height) are accurate.

The Disadvantage

- The disadvantage is that if local grid coordinates are desired, the local ellipsoid and map projections must be known. In addition if the local coordinates are not accurate within themselves, any new points measured using GPS may not fit into this existing local system once transformed.
- In order to obtain accurate ellipsoidal heights the Geoid separation at the measured points must be known. This may be determined from a geoidal model. Many countries do not have access to an accurate local geoidal model. See also [Geoid Model](#).

Other transformation approaches:

[Classical 2D](#)

[One Step](#)

[Two Step](#)

[Interpolation](#)

[Stepwise](#)

[Which approach to use](#)

One Step

This transformation approach works by treating the height and position transformations separately. For the position transformation, the WGS84 coordinates are projected onto a temporary Transverse Mercator projection and then the shifts, rotation and scale from the temporary projection to the "real" projection are calculated.

The Height transformation is a single dimension height approximation.

Because of the way in which the position transformation approach works it is possible to define a transformation without any knowledge of the local map projection or local ellipsoid.

As with the [Interpolation](#) and [Stepwise](#) approaches, the height and position transformations are separate and therefore errors in height do not propagate into errors in position. Additionally, if knowledge of local heights is not good or non-existent you can still create a transformation for position only. Also, the height points and position points do not have to be the same points.

Because of the way in which the transformation works it is possible to compute transformation parameters with just one point in the local and WGS84 system.

The combinations of the number of points in position and the position transformation parameters that can be calculated from them are as follows:

<u>No. of position points</u>	<u>Transformation Parameters Computed</u>
1	Classical 2D with shift in X and Y only
2	Classical 2D with shift in X and Y, Rotation about Z and Scale
more than 2	Classical 2D with shift in X and Y, Rotation about Z, Scale and Residuals

The number of points with height included in the transformation directly affects the type of height transformation produced.

<u>No. of height points</u>	<u>Height transformation based on</u>
0	No height transformation
1	Constant height transformation
2	Average constant between the two height points.
3	Plane through the three height points
more than 3	Average plane

The Advantages:

- The advantages of this method are that transformation parameters may be computed using very little information. No knowledge is needed of the local ellipsoid and map projection and parameters may be computed with the minimum of points. Care should be taken however when computing parameters using just one or two local points as the parameters calculated will only be valid in the vicinity of the points used for the transformation.

The Disadvantage:

- Disadvantages of this approach are the same as for the [Interpolation](#) approach in that the area of the transformation is restricted to about 10km square (Using 4 common points).

Other transformation approaches:

[Classical 3D](#)

[Classical 2D](#)

[Two Step](#)

Interpolation

Stepwise

Which approach to use

Two Step

This transformation approach works by treating the height and position transformation separately. For the position transformation the WGS 84 coordinates are first transformed using a Classical 3D **pre-transformation** to obtain preliminary local cartesian coordinates. These are projected onto a preliminary grid using the specified ellipsoid and map projection. Then the 2 shifts, the rotation and the scale factor of a Classical 2D transformation are calculated to transform the preliminary to the "real" local coordinates.

The position transformation requires knowledge of the local map projection and the local ellipsoid. However, as the distortions of the map projection are taken into account, Two Step transformations can be used for larger areas than One Step transformations.

The height transformation is a single dimension height approximation.

As with the **Interpolation**, **Stepwise** or **One Step** approaches, the height and position transformations are separate and, therefore, errors in height do not propagate into errors in position. Additionally, if knowledge of local heights is not good or non-existent you can still create a transformation for position only. Also, the height points and position points do not have to be the same points.

Because of the way in which the transformation works it is possible to compute transformation parameters with just one point in the local and WGS84 system.

The combinations of the number of points in position and the position transformation parameters that can be calculated from them are as follows:

<u>No. of position points</u>	<u>Transformation Parameters Computed</u>
1	Classical 2D with shift in X and Y only
2	Classical 2D with shift in X and Y, Rotation about Z and Scale
more than 2	Classical 2D with shift in X and Y, Rotation about Z, Scale and Residuals

The number of points with height included in the transformation directly affects the type of height transformation produced.

<u>No. of height points</u>	<u>Height transformation based on</u>
0	No height transformation
1	Constant height transformation
2	Average constant between the two height points.
3	Plane through the three height points
more than 3	Average plane

The Advantages:

- Errors in local heights do not affect the position transformation
- The points used for determining the position and height transformation do not necessarily have to be the same points.
- The distortions of the map projection are taken into account which enables you to use this kind of transformation for larger areas.

The Disadvantage:

- Knowledge of the local projection and local ellipsoid are required.

Other transformation approaches:

Classical 3D

Classical 2D

One Step

Interpolation

Stepwise

Which approach to use



Results View

Results (Datum/ Map)

This view displays the residuals of the Transformation and allows you to store the transformation parameters to the Coordinate System database.

The point numbers of System A and B are listed together with the residuals of the three coordinate components. Additionally the residuals for Position and Position+Height are listed.

Residuals exceeding the limits set under **Configuration: Outliers** will be marked with an exclamation mark ().

- If you are satisfied with the Residuals continue with **Store transformation parameter set** otherwise return to the  **Match Points** view and reselect the common points.
- If you want to display or print a detailed report about the transformation click on the  **Report** tab.
- To graphically display a statistical summary of the residuals click on the  **Chart** tab.

Select from the Index to learn more about the Results view:

[Display Absolute Values](#)

[Change Coordinate Type of residuals](#)

[Save as](#)

[Store transformation parameter set](#)

Configuration: Outliers

Enables you to set the limits for outlier detection in the residuals. I.e. point residuals matching one or more of the following conditions will be indicated with an exclamation mark () in the Result View.

The limits may be set individually for **Position difference**, for **Height difference** and for **Pos.+Hgt. difference**.

You may either set all limits to **ignore** or set the first limit to **use** and connect the remaining limits with the argument **and** or the argument **or**.

Note:

- Various combinations of arguments and limits are theoretically possible. However most logical will be to set the **Position difference** to **use** and connect the others with the argument **or** and enter realistic values for the limits.

Store Transformation Parameters

Enables you to store the transformation parameter set into the Coordinate System database, create a new Coordinate System and attach the new Coordinate System to the Project of system A.

1. Select **Store** from the Context-Menu (right-click).
2. Enter **Name of new parameter set**.
3. Check **Automatically create new coordinate system** if you want to create a new coordinate system based on the map projection and ellipsoid of system B. By default the name will be identical with the name of the parameter set above. This may be changed if you wish.

Note: If the set of Transformation Parameters was calculated between two WGS84 systems the map projection for the new system will be set to 'None' and the ellipsoid will be WGS84, irrespective of the local Ellipsoid attached to System B.

4. Determine how the residuals of the transformation shall be distributed when the new coordinate system is used with a project. If you do not want the residuals to be distributed select 'No distribution' from the **Distribution of residuals** combo box.
5. Check **Automatically attach to project A...** if you wish to attach the new coordinate system to the Project of system A.
6. Press **OK** to confirm or **Cancel** to abort the function.

Note:

- You may also just type a name, uncheck the boxes and then use the [Coordinate System Management](#) to manually create a Coordinate System and the [Project Management](#) to manually change the Coordinate System of the Project of system A.

Change Coordinate Type of Residuals

Allows in the case of a **Classical 3D** transformation to display the residuals in *Cartesian* or *Grid* format.

- From the Context-Menu (right-click) select **Coordinate Type**. Select between *Cartesian* and *Grid*.

Note:

- If the residuals are displayed in *Cartesian* format the Position values will not be listed.

Display Absolute Values of Residuals (Datum / Map)

This function enables you to display the absolute values of residuals. This may be required if you want to sort the residuals by the coordinate components in order to find the biggest value.

Per default relative values will be shown.

- In the Results View select **Absolute Values** from the Context-Menu (right-click) to switch between absolute and relative values.

Tip:

- To sort the residuals by the coordinate components click on the appropriate column heading.

Chart

Chart

The 3-dimensional Chart enables you to graphically display a statistical summary of the residuals. Along the x-axis different predefined ranges of residuals are listed while in the y-axis the number of points that are lying in each range are indicated. The z-axis displays the different coordinate components.

The ranges of the x-axis are configurable via the different choices in the **Chart content** pane. The y-axis is set automatically according to the max. number of residuals in a range. The items on the z-axis may be switched on or off via the **Legend** entries.



Legend:

Allows you to select the items for the z-axis. Per default all items are displayed. Click on individual items to deselect them.

Chart content:

The scale specifies ranges of residuals along the x-axis. The following predefined ranges can be selected:

Coarse: 6 non-linear ranges with a large scale
Fine: 20 non-linear ranges with a small scale
Linear 0-1 m: 11 linear ranges with 10 cm steps
Linear 0-5 m: 11 linear ranges with 50 cm steps
Standard: 11 non-linear ranges with an average scale

- If you are satisfied with the Residuals continue with **Store transformation parameter set** otherwise return to the  **Match Points** view and reselect the common points.
- If you want to display or print a detailed report about the transformation click on the  **Report** tab.

Select from below to learn more about the Chart view:



[Copy a chart to the clipboard](#)

[Save a chart to a file](#)

[Print a chart](#)

[Store transformation parameters](#)

Print a chart

- To print the chart to your default printer, select **Print** from the **File** main menu or click on  in the toolbar.
- For a print preview select **Print Preview** from the **File** main menu or click on  in the toolbar.

Copy a chart to the clipboard

Enables you to copy the chart to the clipboard.

- Right-click in the chart and select Copy from the context menu.

The chart will be copied to the clipboard for further use in different applications.

Save a chart to a file

Enables you to save the chart to a file to use it in other applications.

1. Right-click on the chart and select **Save chart....** In the following dialog select between:

- Windows Bitmap (*.bmp) or
- Windows Meta file (*.wmf).

Tick **Include Legend** if you wish the Legend to be included into the file.

2. Browse to the location where the file shall be stored, select a file name and press **Save**.

Note:

- Alternatively, you can [Copy the chart to the clipboard](#) and paste it into your preferred editor or application.

Report

Report View (Datum/ Map)

The Report View generates a detailed Report about the transformation. The report lists the projects from which the transformation has been calculated, the details of the coordinate system attached to the local project (B), the transformation parameters, the common points and the residuals.

To view the transformation report:

- Go to the  **Report** View. The report on the currently computed transformation opens as an embedded report.

Embedded reports can be printed or saved as HTML files:

- To save a report as an HTML file right-click inside the report and select **Save As...**
- To print a report right-click inside the report and select **Print**. A **Print Preview** is also available from the context menu.
- To select the contents and the layout of the report refer to: [Configure a Report](#)

When the report has been configured to display all possible sections it presents you with the following information:

- [Project Information](#)
- [Coordinate System Information System B](#)
- [Transformaton Details](#)
- [Residuals](#)
- [List of identical points](#)

Project Information

[Example:](#)

Project Information		
	System A	System B
Project name:	PP Sample	PP Sample Local

This section indicates the name of the projects from which the transformation has been derived.

Coordinate System Information System B

[Example:](#)

Coordinate System Information System B

Coordinate system name: UTM32
 Created: -
 Transformation name: -
 Transformation type: -
 Height mode: -
 Residuals: -
 Local Ellipsoid: Bessel
 Projection: UTM32 North
 Geoid model: -
 CSCS model: -

Information on the **Coordinate System B** as defined in the [Coordinate System Properties](#) is given. Depending on the selected [transformation type](#) parts of this information are used to calculate the transformation parameters.

Transformation Details

At the top of this section the height mode of the calculated transformation is displayed. In case of a [Two Step](#) transformation the name of the pre-transformation is displayed as well.

Depending on the transformation type the content of the following section varies:

	3D Helmert (pre-)transformation	2D positional transformation	1D height approximation
Classical 3D	7 parameters calculated	---	---
Stepwise	3 shifts calculated	2D Helmert	height transformation
Two Step	predefined pre-transformation	2D Helmert	height transformation
One Step	---	2D Helmert	height transformation
Interpolate	---	2D affine transformation	height transformation
Classical 2D	---	2D Helmert	

The calculated transformation parameters and the rms values are listed for the various transformation types. For *Classical 3D* transformations up to 7 parameters of a Classical 3D Helmert transformation can be derived. For other transformation types this section is split into listing the parameters of a 2D positional transformation and a 1D height transformation. The positional transformation parameters are the elements of a 2D Helmert transformation or of a 2D affine transformation (in case of transformation type *Interpolate*). The height transformation section lists the parameters of the plane height approximation between the WGS84 ellipsoidal heights of Project A and the local heights of Project B.

[Example for a Classical 3D transformation:](#)

Transformation details

Height mode: Orthometric

3D-Helmert transformation

Number of common points: 3
 Sigma a priori: 1.0000
 Sigma a posteriori: 0.0025
 Transformation model: Bursa-Wolf

No.	Parameter	Value	rms
1	Shift dX	-672.5756 m	11.7367 m
2	Shift dY	-8.9550 m	9.6166 m
3	Shift dZ	-386.5988 m	10.7395 m
4	Rotation about X	-1.01435 "	0.27597 "
5	Rotation about Y	-0.42612 "	0.45154 "
6	Rotation about Z	-0.82383 "	0.28743 "
7	Scale	-1.7226 ppm	1.1815 ppm

[Example for a One Step transformation:](#)

Transformation details

Height mode: Orthometric

2D-Helmert transformation

Number of common points: 4
 Sigma a priori: 1.0000
 Sigma a posteriori: 0.0171
 Rotation origin: X0: 0.0789 m
 Y0: 0.0114 m

No.	Parameter	Value	rms
1	dE	5248079.8765 m	0.0086 m
2	dN	549693.8496 m	0.0086 m
3	Rotation	-0° 29' 04.60243"	0° 00' 01.47786"
4	Scale	-368.1239 ppm	7.1675 ppm

Height transformation

Number of common points: 4
 Mean transformation accuracy: 0.0151 m
 Parameters: 0.00000426 0.00000747 -41.5611 m
 Inclination of height in X: 0° 00' 00.87869"
 Inclination of height in Y: 0° 00' 01.54080"

Residuals

The Residuals section lists the residuals for the identical points. For *Classical 3D* transformations the residuals are displayed in *Cartesian* and *Grid*, for other transformation types only *Grid* residuals can be displayed. The selected point type (Position, Height, Position + Height) is listed as well.

[Example:](#)

Residuals

Grid:

System A	System B	Point type	dE [m]	dN [m]	dHgt [m]
309	309	Position + height	0.0104 m	0.0203 m	-0.0095 m
315	315	Position + height	-0.0192 m	-0.0086 m	0.0048 m
401	401	Position + height	0.0000 m	0.0000 m	0.0095 m
402	402	Position + height	0.0088 m	-0.0117 m	-0.0048 m

In a graphical overview the residuals are visualized. The graphical representation of the position (red arrows) and the height (red bars) residuals may be switched on or off separately. When the mouse cursor is moved onto a residual representation then the values for dE, dN or dH are displayed in a little popping up text box.

Example:

Graphical overview:

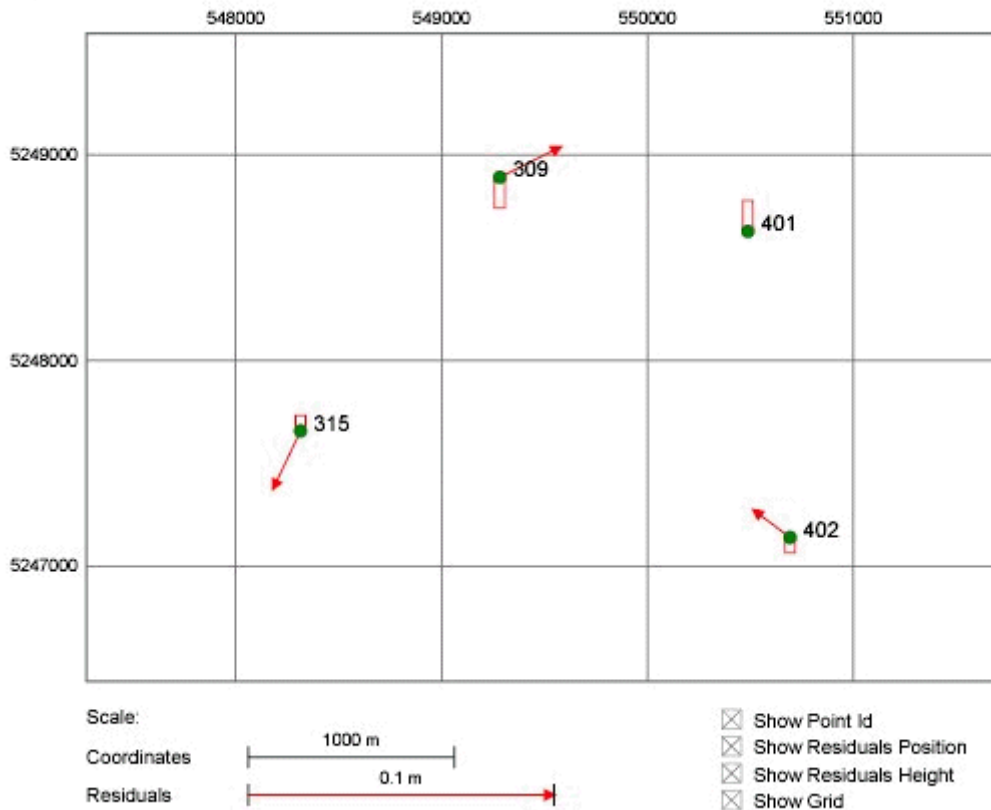

List of identical points

This section lists the Point IDs and the coordinates of the identical points. Depending on the calculated transformation type one or more of the following coordinate representations are available in the report template: System A Cartesian, System A Local Grid transformed, System B Cartesian, System B Local Grid.

Example:

List of identical points

System A:

WGS 84 Cartesian:

	X [m]	Y [m]	Z [m]
309	4264539.9452	725265.0731	4671940.4754
315	4265595.8591	724452.5161	4671117.2238
401	4264537.3051	726484.7439	4671757.2588
402	4265586.7181	726858.3210	4670752.8015

System B:

Local Grid:

	Easting [m]	Northing [m]	Hgt [m]
309	549282.2200	5248890.1600	413.0500
315	548314.8800	5247659.3600	419.7200
401	550486.8039	5248627.7615	414.9700
402	550691.5400	5247142.5400	418.6700

COGO Calculations

Cogo Calculations

The COGO Calculations tool allows you to perform coordinate geometry calculations such as:

- the calculation of point coordinates.
- the calculation of bearings between points.
- the calculation of distances between points.

To invoke the Cogo Calculations:

- Select **Tools** from the main menu and then  **COGO Calculations....** The Cogo Calculations view opens as a [four-pane view](#) in a stand-alone window, which is listed in the **Open Documents** list bar.

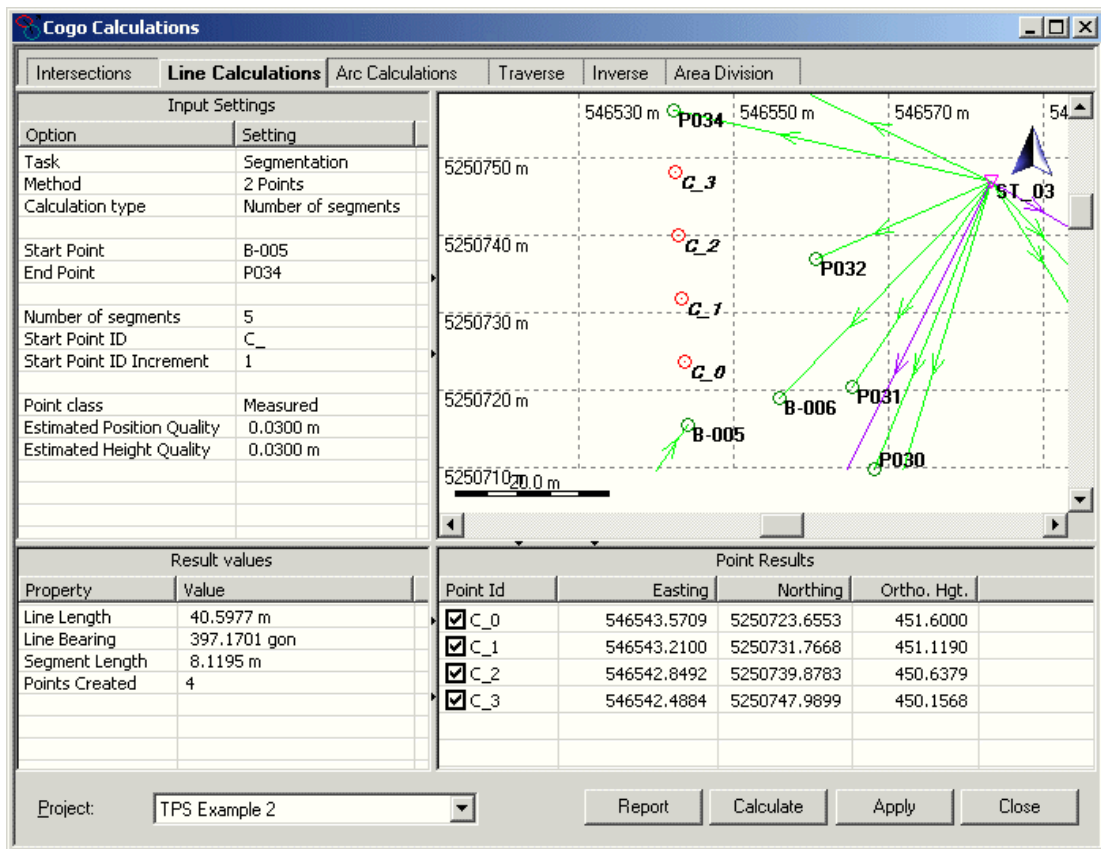

To perform a Cogo Calculation the necessary input data has to be selected from a project. The project can be selected from a combo box at the bottom of the view. All points which are either **stored as local grid** or can be **converted to local grid** in the selected project may serve as input to the selected Cogo Calculation method.

- If the Cogo Calculations tool is invoked and no project is open select a project from the combo box.
- If one or more projects are open then the project which is active when the Cogo Calculations are invoked will be the selected project in the Cogo Calculations view. If you wish a different project to be selected for input choose one from the **Projects** combo box. The **Input Settings** will be reset.
- The graphical pane of the Cogo Calculations view shows the points and observations of the selected project in the so-called **Cogo Map view**.

The following groups of possible methods are supported. To switch between groups select a different tab.

Intersections

Line Calculations

Arc Calculations



Traverse

Inverse

Area Divisions

For each group the **Input Settings**, the **Result Values** of the computation and the **Point Results** (point coordinates of the newly calculated points) are displayed in separate property/ report views. The available **Input Settings** depend on the selected **Task/ Method** and can be in-line edited.

Points can be picked from the currently selected project in the [Cogo Map view](#). Alternatively, points can be selected from drop-down list boxes. The current point coordinates will be used for the calculation. Note that only point triplets, which are either stored with Local Grid coordinates or which can be converted to Local Grid can be used.

- To zoom in or out of the Map view right-click and select **Zoom In**, **Zoom Out** or **Zoom 100%** from the view's background menu. Alternatively, use the corresponding toolbar buttons (, ) from the **View** toolbar.
- By default, **Panning** is switched on so that you can comfortably navigate within the view. The **Scroll to selected point** tool makes it easy to focus on a special point.
- To modify the Graphical Settings right-click and select **Graphical Settings...** from the background menu. A **Color** and **Font** different from the color and font of points already stored in the project, may be specified for the newly calculated COGO points.
- To view the **Point Properties** right-click on a point in the Map view and open the **Point Properties** property-page from the context menu.

To select a point for a Cogo Calculation:

1. Set the focus onto the **Input Settings** field for which you want to select a point.
2. Double-click on a point in the **Cogo Map view**. The current point coordinates will be transferred to the selected **Input Settings** field.

Alternatively: Right-click on a point in the **Cogo Map view** and select the **Input Settings** field to which the current coordinates of the selected point shall be transferred from the context menu. You may also double-click onto the **Input Settings** field and select a point from the drop-down list box.

Distances and Bearings can either be entered directly via in-line edit or calculated from two points in the project. The functionality for calculating bearings and distances (**Inverse** calculations) is embedded in the in-line edit functionality.

To perform an Inverse calculation:

1. Double-click onto the corresponding **Input Setting** to open the in-line edit field. Click the browse button  to open the **Inverse** dialog.
2. In the **Inverse** dialog select a **Start Point Id** and an **End Point Id** for calculating the **Bearing** (azimuth) and **Distance** between those points. The calculated values are taken over for azimuth values/ angle right values, horizontal distances and offset values into the Cogo Calculation.

Alternatively, you may select a **Start Point** and an **End Point** for calculating the bearing (azimuth) and distance between those points in the **Cogo Map view**.

1. Left-click on any point in the Map view to select the **start point** for the **Inverse** calculation.
2. Keep the **Shift**-key (or the **CTRL**-key) pressed while selecting a second point as the **end point**.
3. From the background menu select the **Input Settings** field to which the calculated **Bearing** or **Distance** shall be transferred as azimuth value/ angle right value, horizontal distance or offset value.

Once the options are set the Cogo calculation may be performed.

- Press the **Calculate** button to perform the selected Cogo Calculation. The newly calculated point(s) are displayed in the Cogo Map view. The **Color** of the point symbols and the **Font** of the Point Id can be configured via the [Graphical Settings](#).
- Press the [Report](#) button to get an HTML based report on the results of a Cogo Calculation.
- Press the **Apply** button to take the results of the computation over into the selected project. The newly computed points will be stored in the selected project.

If a Cogo calculation delivers more than one result (e.g. a Bearing-Distance or a Distance-Distance calculation) then the result not needed may be de-selected in the **Point Results** report view. Only the active coordinates will be taken over into the project.

A default name is already suggested for the newly computed points. You can rename the point Id by right-clicking on the point and selected **Modify...** from the context menu.

The **Point Class** for the points to be calculated may be selected for each **Task/ Method**. The Point Class can be changed to *Control*, *Measured* or *Estimated*.

For each Task/ Method which delivers 3D point coordinates (position and height) an **Estimated Position Quality** and an **Estimated Height Quality** may be entered for the points to be calculated. Most of the Cogo Calculations just deliver 2D point coordinates (position only) so that for these methods just an **Estimated Position Quality** may be entered for the points to be calculated.

Note:

- The Cogo Calculations tool is only available to you if it is included in your [licence](#).

Graphical Settings

Graphical Settings (Cogo)

The Graphical Settings Property-Sheet enables you to configure the graphical view. You may configure which items to display, select the colors of graphical elements and the font for text items.

1. Right-click select **Graphical Settings...** from the context menu.
2. In the Property-Sheet use the tabs to switch between the following pages:

View
Grid
Color
Font

3. Make your changes or press the **Default** button to apply the default values to the parameters of a page.
4. Press **OK** to confirm or **Cancel** to abort the function.

Graphical Settings: View

This Property-Page enables you to define which graphical elements shall be displayed in the **Cogo Map view**.

General:

Grid

Check to display a coordinate grid.

Note: To configure the grid see: [Grid](#).

North Arrow

Check to display an arrow in the upper right corner pointing to the north.

Scale Bar

Check to display a Scale Bar in the lower left corner of the screen. The Scale bar will alter its size and description to suit the scale at which you are zoomed in at. Additionally, the scale bar will appear on any printout that you make, when activated.

Legend

Check to display a legend listing the point symbols of all possible point classes.

Data:

Point Ids

Check to display the Point Identifications

Note: To configure the font see: [Font](#). To configure the color see: [Color](#).

Cogo Point Ids

Check to display the Point Identifications for points resulting from Cogo Calculations but not being stored into the project, yet.

Note: To configure the font see: [Font](#). To configure the color see: [Color](#).

Height Value

Check to display the Height Values. The *orthometric* or the *ellipsoidal* height value is displayed **depending on** the choice you made in the [Tools- Options: Units/ Display](#) dialog page.

Note: Only if the requested height mode is available will a height value be displayed. And height values are only displayed if the font for **Point Id** is a  True Type font. To configure the font see: [Font](#).

GPS Observations

Check to display the GPS baseline vectors

Note: To configure the color of the baseline vectors see: [Color](#).

TPS Observations

Check to display the TPS (direction and distance) measurements

Note: To configure the color of the TPS observations see: [Color](#).

Azimuth Observations

Check to display the Azimuth measurements

Note: To configure the color of the Azimuth observations see: [Color](#).

Level Observations

Check to display the height difference observations

Note: To configure the color of the Level observations see: [Color](#).

Graphical Settings: Color

This Property-Page enables you to set the color of the database items.

- In the **Color** column double-click onto the corresponding color field and select a color from the in-line edit combo box.

Selected Objects

Select a color from the in-line edit combo box to set the color of selected point symbols and observations.

De-activated Objects

Select a color from the in-line edit combo box to set the color for de-activated point symbols and observations.

Point Symbols

Select a color from the in-line edit combo box to set the color of the point symbols.

Cogo Point Symbols

Select a color from the in-line edit combo box to set the color of the point symbols for points resulting from Cogo Calculations before they are stored in the project.

GPS Observations

Select a color from the in-line edit combo box to set the color of the GPS baselines.

TPS Observations

Select a color from the in-line edit combo box to set the color of the TPS measurements.

Azimuth Observations

Select a color from the in-line edit combo box to set the color of the azimuth measurements.

Level Observations

Select a color from the in-line edit combo box to set the color of the direct leveling measurements.

Background

Select a color from the in-line edit combo box to set the color of the view's background.

Cogo Calculations: Intersections

The group of Cogo Calculation methods called **Intersections** comprises of the following methods:

By Point

Define two intersecting lines by defining a Start and an End Point for the first line (**1st** and **2nd Point**) and a Start and an End Point for the second line (**3rd** and **4th Point**). If the **Use Offsets** option is set to **Yes** then for each line an offset may be defined or calculated.

[Illustration:](#)

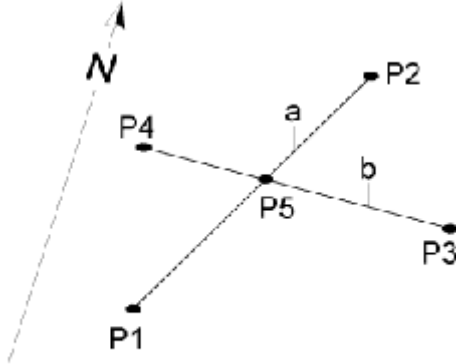

Bearing-Bearing

Define two intersecting lines by defining a Start Point (**1st Point**) and a direction (**Azimuth**) for the first line and a Start Point (**2nd Point**) and a direction (**Azimuth**) for the second line. If the **Use Offsets** option is set to **Yes** then for each line an offset may be defined or calculated.

[Illustration:](#)

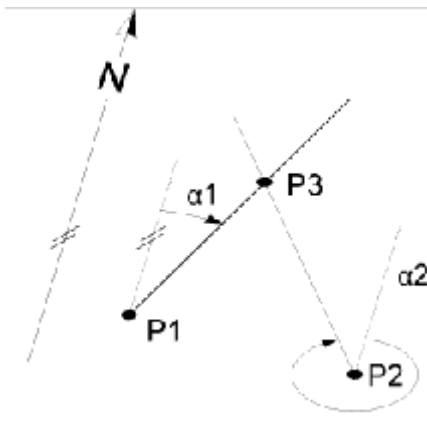

Bearing-Distance

Define a line and an intersecting circle by defining a Start Point (**1st Point**) and a direction (**Azimuth**) for the line and a center point (**2nd Point**) and a radius (**Horizontal Distance**) for the circle. The method may deliver one result (in case of the line being a tangent to the circle) or two results. Select the needed **Point Result** via the checkbox.

If the **Use Offsets** option is set to **Yes** then an offset may be defined or calculated for the intersecting line.

[Illustration:](#)

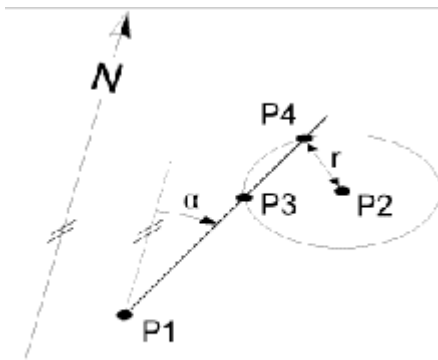

Distance-Distance

Define two intersecting circles by defining a center point and a radius for the first circle (**1st Point** and **Horizontal Distance**) and a center point and a radius for the second circle (**2nd Point** and **Horizontal Distance**). The method may deliver one or two results. Select the needed **Point Result** via the checkbox.

[Illustration:](#)

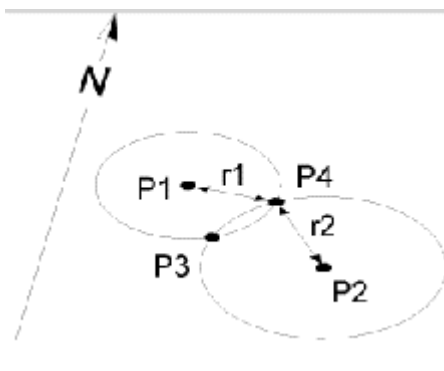

To perform the Cogo calculation and save the results proceed as follows:

- To perform the Cogo Calculation with the specified elements press the **Calculate** button. If the calculation fails because the specified elements do not intersect an error message is issued.
- To take the calculation results over into the selected project press the **Apply** button. The **Point Class** and the **Estimated Position/ Height Quality** of the calculated points will be as specified in the Cogo Calculations tool (left-hand pane). The **Point Id(s)** of the calculated points may be modified in the Cogo Calculations tools before the points are stored to the project.

Cogo Calculations: Line Calculations

The group of Cogo Calculation methods called **Line Calculations** comprises of the following tasks each allowing for two different methods to define the line:

Methods to define the line:

2 Points	Point/ Bearing/ Distance
The line is defined by a Start Point and an End Point . Any Point in the active project may be selected to define the line.	The line is defined by a Start Point , a bearing (Azimuth) on the Start Point and a Horizontal Distance . The distance value defines the end point of the line.

Line Calculation Tasks:

Calculate Base Point

Use this task to calculate the **Base Point** of a given Offset Point on a Line.

[Illustration:](#)

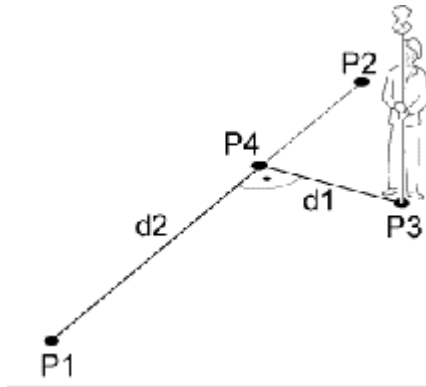

Apart from the Point Result you get the following **Result Values**:

Delta Line:	The line length between the Start Point of the Line and the calculated Base Point .
Delta Offset:	The offset value between the Offset Point and the calculated Base Point .
Line Length:	The line length between the Start Point and the end of the Line.
Line Bearing:	The line bearing on the Start Point of the Line.
Offset Point Bearing:	The bearing on the calculated Base Point to the given Offset Point .

Calculate Offset Point

Use this task to calculate an **Offset Point** to a given Line. In the left-hand pane specify the **Delta Line** value and the **Offset** value to calculate the Offset Point.

Apart from the Point Result you get the following **Result Values**:

Line Length:	The line length between the Start Point and the end of the Line.
Line Bearing:	The line bearing on the Start Point of the Line.
Offset Point Bearing:	The bearing on the given Base Point to the calculated Offset Point .

Segmentation

Use this task to segment a given Line.

Two **Calculation types** are available: Use the type **Number of segments** to specify into how many segments the line shall be segmented. Use the type **Segment length** to specify the length of a single segment. The last segment will be of the remaining length between the end of the line and the preceding segment point.

The **Start Point ID** (i.e. the ID of the first segment point) and how it shall be **incremented** can be set as required.

Depending on the method by which the line is defined the number of calculated points varies. If the line is defined by **2 Points** (a **Start Point** and an **End Point**) one point less than the number of segments is calculated. If the line is defined by a **Start Point**, a Bearing (**Azimuth**) and a **Distance** then the number of calculated points corresponds to the number of calculated segments.

Apart from the Point Result you get the following **Result Values**:

Calculation type:	Number of Segments	Segment Length
Line Length:	The line length between the Start Point and the End Point of the Line.	
Line Bearing:	The line bearing on the Start Point of the Line.	
Segment Length:	The resulting length of a single segment.	---
Number of Segments:	---	The resulting number of segments.
Last Segment Length:	---	The length of the segment between the end point of the line and the preceding segment point.
Points Created:	The number of calculated points.	

To perform the Cogo calculation and save the results proceed as follows:

- To perform the Cogo Calculation with the specified elements press the **Calculate** button. If the calculation fails an error message is issued.
- To take the calculation results over into the selected project press the **Apply** button. The **Point Class** and the **Estimated Position/ Height Quality** of the calculated points will be as specified in the Cogo Calculations tool (left-hand pane). The **Point Id(s)** of the calculated points may be modified in the Cogo Calculations tools before the points are stored to the project.
- To save the Result Values right-click and select **Save as** from the context menu. In the **Save as** dialog you may decide under **Lines to save** whether you want to store **All** values or just the **Selected** lines.

Cogo Calculations: Arc Calculations

The group of Cogo Calculation methods called **Arc Calculations** comprises of the following tasks each allowing for five different methods to define the arc:

Methods to define the arc:

3 Points	2 Points/ Radius
The arc is defined by a Start Point , a 2nd Point and an End Point . Any Point in the active project may be selected to define the arc.	The arc is defined by a Start Point , an End Point and a Radius to those two points.

2 Tangents/ Radius	2 Tangents/ Arc Length	2 Tangents/ Chord Length
The arc is defined by a Start Point , the intersection point of the two tangents (PI Point), an End Point and a Radius . Any Point in the active project may be selected to define the arc.	The arc is defined by a Start Point , the intersection point of the two tangents (PI Point), an End Point and the length of the arc between the two tangents (Arc Length). Any Point in the active project may be selected to define the arc.	The arc is defined by a Start Point , the intersection point of the two tangents (PI Point), an End Point and the length of the chord between the two tangents (Chord Length). Any Point in the active project may be selected to define the arc.

Arc Calculation Tasks:

Calculate Arc Center

Use this task to calculate the **Center** point of an Arc.

[Illustration:](#)

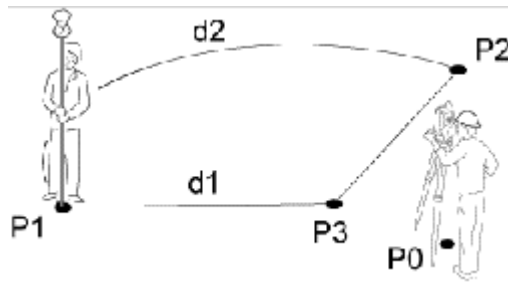

Apart from the Point Result you get the following **Result Values**:

Radius:	The radius value as given or as resulting from an arc definition by 3 Points.
Arc Length:	The length of the arc between the given Start Point and End Point .

Calculate Base Point

Use this task to calculate the **Base Point** of a given Offset Point on an Arc.

[Illustration:](#)

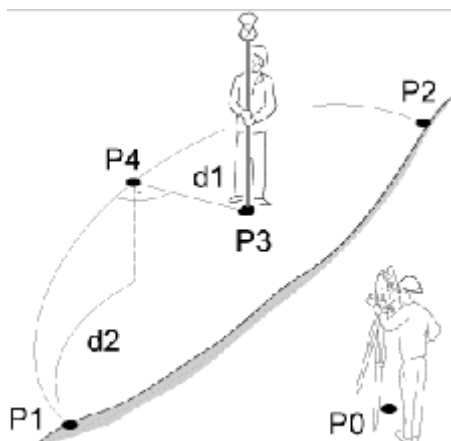

Apart from the Point Result you get the following **Result Values**:

Delta Arc Distance:	The arc length between the Start Point of the Arc and the calculated Base Point .
Delta Offset:	The offset value between the Offset Point and the calculated Base Point .
Radius:	The radius value as given or as resulting from the arc definition.
Arc Length:	The length of the arc between the given points or as resulting from the arc definition.
Offset Point Bearing:	The bearing on the calculated Base Point to the given Offset Point .

Calculate Offset Point

Use this task to calculate an **Offset Point** to a given Arc. In the left-hand pane specify the **Arc Distance** (i.e. the distance from the **Start Point** of the Arc to the Base Point of the Offset Point that shall be calculated) and the **Offset** value to calculate the Offset Point.

Apart from the Point Result you get the following **Result Values**:

Radius:	The radius value as given or as resulting from an arc definition by 3 Points.
Arc Length:	The length of the arc between the given Start Point and End Point .
Offset Point Bearing:	The bearing on the given Base Point to the calculated Offset Point .

Segmentation

Use this task to segment a given Arc.

Three **Calculation types** are available:

- Use the type **Number of segments** to specify into how many segments the arc shall be segmented.
- Use the type **Segment length** to specify the length of a single segment. The last segment will be of the remaining length between the **End Point** of the arc and the last segment point.
- Use the type **Delta Angle** to specify an angle value by which the arc shall be divided into equal segments. The last segment will be of the remaining length between the **End Point** of the arc and the last segment point.

The **Start Point ID** (i.e. the ID of the first segment point) and how it shall be **incremented** can be set as required.

Apart from the Point Result you get the following **Result Values**:

Calculation type:	Number of Segments	Segment Length	Delta Angle
--------------------------	---------------------------	-----------------------	--------------------

Arc Length:	The arc length between the Start Point and the End Point of the Arc.		
Segment Length:	The resulting length of a single segment.	---	The resulting length of a single segment.
Number of Segments:	---	The resulting number of segments.	The resulting number of segments.
Last Segment Length:	---	The length of the segment between the End Point of the arc and the last segment point.	The length of the segment between the End Point of the arc and the last segment point.
Points Created:	The number of calculated points.		

To perform the Cogo calculation and save the results proceed as follows:

- To perform the Cogo Calculation with the specified elements press the **Calculate** button. If the calculation fails an error message is issued.
- To take the calculation results over into the selected project press the **Apply** button. The **Point Class** and the **Estimated Position/ Height Quality** of the calculated points will be as specified in the Cogo Calculations tool (left-hand pane). The **Point Id(s)** of the calculated points may be modified in the Cogo Calculations tools before the points are stored to the project.
- To save the Result Values right-click and select **Save as** from the context menu. In the **Save as** dialog you may decide under **Lines to save** whether you want to store **All** values or just the **Selected** lines.

Cogo Calculations: Traverse

The group of Cogo Calculation methods called **Traverse** allows you to calculate a new (Cogo) point by knowing the direction and distance on a known point to the new point. The **Traverse** Calculations comprise of the following methods:

Azimuth

The new point is calculated from a known point (**From Point**) by a given **Azimuth** value and a given **Horizontal Distance** from the known point to the point to be calculated. If the **Use Offsets** option is set to **Yes** then an offset (negative to the left or positive to the right) may be defined or calculated.

[Illustration:](#)

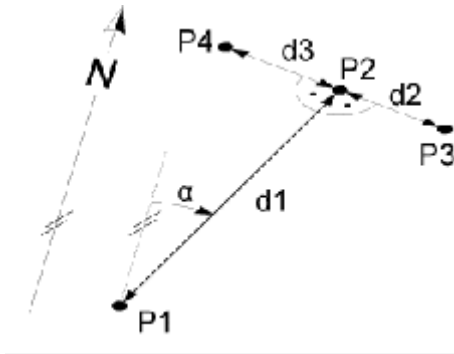

Angle Right

The new point is calculated from a known point (**From Point**) by a given angle difference between a known **Backsight Point** and the point to be calculated (**Angle Right**) and a given **Horizontal Distance** from the known point (**From Point**) to the point to be calculated. If the **Use Offsets** option is set to **Yes** then an offset (negative to the left or positive to the right) may be defined or calculated.

To perform the Cogo calculation and save the results proceed as follows:

- To perform the Cogo Calculation with the specified elements press the **Calculate** button. If the calculation fails an error message is issued.
- To take the calculation results over into the selected project press the **Apply** button. The **Point Class** and the **Estimated Position/ Height Quality** of the calculated points will be as specified in the Cogo Calculations tool (left-hand pane). The **Point Id(s)** of the calculated points may be modified in the Cogo Calculations tools before the points are stored to the project.

Cogo Calculations: Inverse

The group of Cogo Calculation methods called **Inverse** comprises of the following tasks:

Inverse Point - Point

Calculate **Bearing**, **Distance** and **Height Difference** between two points specified in the **From point** and **To point** input fields.

Inverse Point - Line

Calculates the coordinates of a point on a given line that is perpendicular to a given **Offset Point**. The line can either be specified by **2 Points** (Start Point, End Point) or by **Point/ Bearing / Distance** (Start Point, Azimuth, Horizontal Distance).

Apart from the Point Result you get the following **Result Values**:

Delta Line:	The line length between the Start Point of the Line and the calculated point.
Delta Offset:	The offset value between the Offset Point and the calculated point.
Line Length:	The line length between the Start Point and the end of the Line.
Line Bearing:	The line bearing on the Start Point of the Line.
Offset Point Bearing:	The bearing on the calculated point to the given Offset Point .

Inverse Point - Arc

Calculates the coordinates of a point on a given arc that is perpendicular to a given **Offset Point**. The arc can be defined with different methods. For details see: [Arc Calculations](#).

Apart from the Point Result you get the following **Result Values**:

Delta Arc Distance:	The arc length between the Start Point of the Arc and the calculated point.
Delta Offset:	The offset value between the Offset Point and the calculated point.
Radius:	The radius value as given or as resulting from the arc definition.
Arc Length:	The length of the arc between the given points or as resulting from the arc definition.
Offset Point Bearing:	The bearing on the calculated point to the given Offset Point .

To perform the Cogo calculation and save the results proceed as follows:

- To perform the Cogo Calculation with the specified elements press the **Calculate** button. If the calculation fails an error message is issued.
- To take the calculation results over into the selected project press the **Apply** button. The **Point Class** and the **Estimated Position/ Height Quality** of the calculated points will be as specified in the Cogo Calculations tool (left-hand pane). The **Point Id(s)** of the calculated points may be modified in the Cogo Calculations tools before the points are stored to the project.
- To save the Result Values right-click and select **Save as** from the context menu. In the **Save as** dialog you may decide under **Lines to save** whether you want to store **All** values or just the **Selected** lines.

Cogo Calculations: Area Division

The group of Cogo Calculation methods called **Area Divisions** comprises of the following methods to divide an area:

Input values:

Area to use:

From all the areas available in the selected project select the area which shall be divided.

Number of Points/ Area/ Perimeter:

The number of points in the selected area, the area enclosed as well as its perimeter are indicated.

Divide by:

Decide whether the area shall be divided by a given **Percentage** (%), by a given **Area** (m²) or by a **Defined Line**.

Using:

	Parallel Line	Perpendicular Line	Swing Line
Percentage/ Area:	Divides the area by the given amount (% or m ²) using a line parallel to the line through the given Points A and B .	Divides the area by the given amount (% or m ²) using a line perpendicular to the line through the given Points A and B .	Divides the area by the given amount (% or m ²) using a swinging line anchored to a given Rotation point .
Defined Line:	Divides the area by a line parallel to the line through the given Points A and B . Determine the amount (By distance) by which the parallel line shall be shifted ('+' to the right or '-' to the left) or determine a point through which the parallel line shall run.	Divides the area by a line perpendicular to the line through the given Points A and B . Determine the amount (By distance) by which the perpendicular line shall be shifted ('+' to the right or '-' to the left) or determine a point through which the perpendicular line shall run.	---

The values for the start and end point of the reference line have to be entered in the **Point A/ Point B** input fields.

The value for the **Percentage** or the square meters (**Area**) by which the area shall be divided have to be entered in the **Sub Area** input field.

The **Shift** value has to be entered in the **Horizontal Distance** input field.

Result values:

The **Point Results** list the coordinates of the intersecting line with specified area. Apart from the Point Results you get the following **Result Values**:

Area Ratio:	The ratio between the two calculated sub areas is listed.
--------------------	-----------------------------------------------------------

Area 1/ Area 2:	The Sub Area values (% or m ²) for the two calculated sub-areas are listed.
Horizontal Distance:	The Shift value between the separating line and its reference line is listed.
Points created:	The number of newly computed points (intersection points) is listed.

To perform the Cogo calculation and save the results proceed as follows:

- To perform the Cogo Calculation with the specified elements press the **Calculate** button. If the area division fails an error message is issued.
- To take the calculation results over into the selected project press the **Apply** button. The **Point Class** and the **Estimated Position/ Height Quality** of the calculated points will be as specified in the Cogo Calculations tool (left-hand pane). The **Point Id(s)** of the calculated points may be modified in the Cogo Calculations tools before the points are stored to the project.
- To save the Result Values right-click and select **Save as** from the context menu. In the **Save as** dialog you may decide under **Lines to save** whether you want to store **All** values or just the **Selected** lines.

COGO Report

To get an overview on the results of a Cogo calculation in your project you may invoke the **COGO** Report.

- In the **Cogo Calculations** view click the **Report** button to invoke the COGO Report on the results of the most recent Cogo calculation.

The report opens in a stand-alone window and is listed in the **Open Documents** list bar.

Stand-alone reports can be saved as HTML files or printed:

- To save a report as an HTML file right-click inside the report and select **Save As...**
- To print a report right-click inside the report and select **Print**. A **Print Preview** is also available from the context menu.
- To select the **contents** and the **format** of the report right-click and select **Properties...** from the context menu or click  in the **Reports** toolbar. For further details refer to: [Configure a Report](#).

When the report has been configured to display all possible sections it presents you with the following information:

- [Project Information](#)
- [Input Settings](#)
- [Input Coordinates](#)
- [Point Results](#)
- [Result Values](#)

Project Information

[Example:](#)

Project Information	
Project name:	P_TPS
Date created:	24-01-07 12:38:39
Time zone:	1h 00'
Manager:	Mr. Johnson
Client:	Little Hut Company
Street:	Woods Lane
Coordinate system name:	utm32n
Application software:	LEICA Geo Office 5.1

This section gives you general information on the [Project Properties](#), like the project name, creation date and time and the attached coordinate system.

If information has been entered in the [Dictionary](#) page of the Project Properties dialog these pieces of information will be added to this section of the report.

Input Settings

[Example:](#)

Input Settings

Line Calculations

Task:	Segmentation
Method:	2 Points
Calculation type:	Number of segments
Start Point:	1000
End Point:	1016
Number of segments:	10
Start Point ID:	Cogo
Start Point ID Increment:	1
Point class:	Measured
Estimated Position Quality:	0.0300 m
Estimated Height Quality:	0.0300 m

This section lists the **Input Settings** as chosen in the Cogo Calculations view. Depending on the chosen **Task** and **Method** the listed **Settings** vary.

Input Coordinates

[Example:](#)

Input Coordinates

Point ID	Easting [m]	Northing [m]	Ortho.Hgt. [m]
1000	546517.1417	5250666.3558	449.3780
1016	546570.3020	5250691.5320	449.0600

The coordinates of the points on which the calculation was based are listed in the section **Input Coordinates**.

Point Results

[Example:](#)

Point Results

Point ID	Easting [m]	Northing [m]	Ortho.Hgt. [m]	Ellip.Hgt. [m]	Applied
Cogo0	546522.4577	5250668.8734	449.3462	-	✘
Cogo1	546527.7737	5250671.3910	449.3144	-	✘
Cogo2	546533.0898	5250673.9086	449.2826	-	✘
Cogo3	546538.4058	5250676.4263	449.2508	-	✘
Cogo4	546543.7218	5250678.9439	449.2190	-	✘

This section lists the Cogo points and their coordinates which have been newly calculated according to the selected Cogo **Task** and **Method**. It is indicated to you whether the point results have been **applied** to the project or not.

Result Values

[Example:](#)

Result Values

Line Length:	58.8206 m
Line Bearing:	71.8424 gon
Segment Length:	5.8821 m
Points Created:	9

This section displays the **Result values** of the Cogo calculation. Depending on the selected **Task** and **Method** the resulting values vary.

Data Exchange Manager

Data Exchange Manager

The Data Exchange Manager (DXM) enables you to transfer data between an instrument connected to the serial or the USB port and your PC. It can also be used to convert database objects (e.g. projects) into objects for the instruments (e.g. jobs).

In LGO the following instruments are supported:

- SmartWorx Viva
- System 1200 (GPS and TPS)
- GPS - System 900
- GPS - System 500
- TPS - 300, 400, 700, 800, 1000, 1100, RCS 1100, BUILDER
- RX 1250/ RX 900
- TS 02/06/09
- TS 30/ TM 30
- DNA (DNA 03, DNA 10), SPRINTER

Depending on the instrument type the instruments may contain different memory devices which can be addressed via serial communication or via USB:

Internal Memory

Local Memory devices

System Memory

On your PC you can also transfer data from and to any of the installed local memory devices.

The Data Exchange Manager (DXM) consists of a two-pane view. Each pane shows the Contents of the selected location in a tree-view.

[Example:](#)

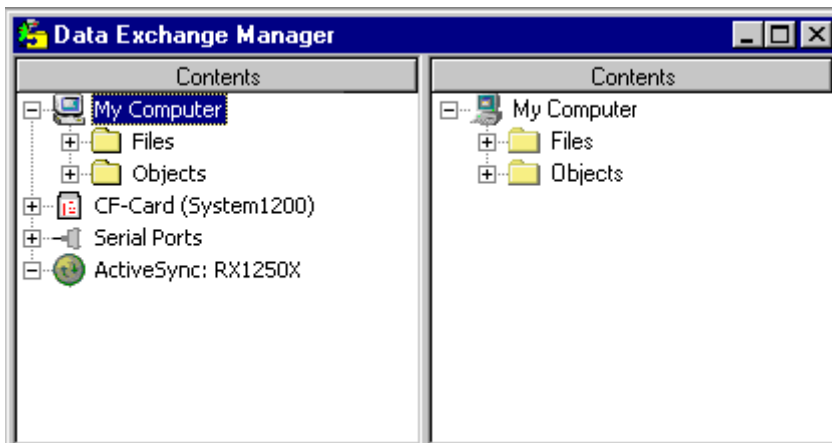

The **left-hand** tree-view shows the following nodes:

My Computer

Local Memory

Serial Ports/ USB

The **right-hand** tree-view shows only Database **Objects** (such as e.g. Projects or Coordinate Systems) and **Files** as contained in the 'My Computer' location.

Transfer from or to the PC or one of the instrument's memory devices or from or to a local memory device (SD-/CF-/PC-card or USB-stick) is achieved via drag & drop or copy & paste from the right to the left hand side or vice versa:

- Uploading files to the instrument
- Downloading files from the instrument
- Uploading objects to the instrument
- Downloading objects from the instrument

Note:

- Objects can only be addressed and transferred for SmartWorx and for GPS System 500 instruments.
- The connection with the SmartWorx Viva or with RX1250 (or RX900) can only be established using **ActiveSync**. Connect the instrument to the **USB port** of your computer and ensure that the firmware is running. Also ensure that the ActiveSync and the USB driver are correctly installed.

To start the Data Exchange Manager:

- From the **Tools** menu select  **Data Exchange Manager** or click on  within the **Tools List Bar**.

Select from the list below to learn more about the Data Exchange Manager:

Refresh

Delete a file or folder

Rename a file or folder

New Folder

General Settings

COM/USB Settings

View the contents of a file

View/ Hide objects

Object Properties

Transfer objects of the Office database

Transfer objects of the instrument

Object Properties

In the Data Exchange Manager object properties can be displayed for all objects in the  **My Computer** location.

For database objects (i.e. Projects, Coordinate systems, Antennas and Codelists) the same property pages as those invoked from inside the corresponding management components can be displayed.



- Right-click on the object which properties you want to view/ edit and select **Properties...** from the context menu.

For non-database objects, i.e. Geoid model field files, CSCS model field files and Format files a property page will be displayed which identifies the **File Name** and **Location** of the specific object. This may be of importance when in the given **Search Path** more than one object of the same name has been found. Both will be displayed in the corresponding  **Objects** sub-folder and can then only be differentiated by their individual location.

Note:

- The properties of objects stored in one of the instrument's memory devices cannot be invoked via serial communication in the Data Exchange Manager.

New Folder



In the Data Exchange Manager new folders may be created either in the  **My Computer** location or in the  **Local memory** location.

1. Go to the directory into which the new folder shall be inserted.
2. Right-click on a file or folder in the selected directory and select **New Folder** from the context menu.

Note:

- New folders cannot be created in one of the instrument's memory devices via serial communication.

Rename a file or folder



In the Data Exchange Manager files or folders may be renamed either in the  **My Computer** location or in the  **Local Memory** location.

- Right-click on the file or folder to be renamed and select **Rename** from the context menu.

Note:

- Files or folders cannot be renamed in one of the instrument's memory devices via serial communication.
- Objects cannot be renamed in the Data Exchange Manager.

Delete a file or folder

In the Data Exchange Manager files or folders may be deleted from either the  **My Computer** location or from the  **Local memory** location.

- Right-click on the file or folder to be deleted and select **Delete** from the context menu.

Note:

- Files or folders cannot be deleted from one of the instrument's memory devices via serial communication.
- Objects cannot be deleted in the Data Exchange Manager.

Refresh



After a transfer action from or to the instrument it may be necessary to refresh the view before you can see the transferred file or object displayed in the corresponding folder(s). This may also be necessary if you change the local memory device inside your local memory device drive on the PC or inside the local memory device slot of an instrument connected to a serial port.

Note: Database objects and files of the **My Computer** location will always be dynamically refreshed.

Tip:

- When you cannot find a file or object after transfer in the directory where it should have been transferred to, right-click in the corresponding tree-view (left or right tree-view) and select **Refresh** from the context menu. Only if it does not show up then, start looking for other reasons, like problems with the serial communication.

View/ Hide objects

In the Data Exchange Manager you can individually decide whether you want to see the  **Objects** node in the   **My Computer** location or not.

- Right-click in either of the two tree-views and select/ de-select **View Objects** from the context menu.

The **Objects** node appears/ disappears in both trees simultaneously. To hide the **Objects** node may be of special interest for TPS instruments which support only the upload/ download of **Files**.

View the contents of a file

To quickly view the contents of an ASCII file:

- Right-click on the file and select **View...** from the context menu.



The content of the file will be displayed in the **Text editor** specified in the [Options: General](#) page.





Note:

- The content of files stored in one of the instrument's memory devices cannot be viewed via serial communication.

Locations

DXM location: My Computer

The  **My Computer** location on the right-hand side contains two sub-folders,  **Files** and  **Objects**.

- When you open the  **Files** directory all files and sub-directories on your hard disk are displayed. If you are connected to a network you will also see all the network drives. However, if you have a local memory drive connected or built-in to your PC this will not show up.
- When you open the  **Objects** directory all **loadable objects** contained in the Office database are listed. They are grouped into sub-directories like  **Projects**,  **Coordinate Systems** etc.

DXM location: Local Memory (SD-card, CF-card, PC- card, USB stick)

The  **Local Memory** location only shows up in the Data Exchange Manager if your PC has a local memory drive installed. The Drive Letter (e.g. E:\ or F:\) has to be specified under [Tools-Options: General](#).



The **Local Memory** location displays the content of any SD-card, CF-card, PC-Card or USB stick inserted into the local memory drive. It only shows  **Files**.

When you have formatted the local memory device on your instrument then it will have a pre-defined directory structure. Depending on the kind of instrument the directory structure varies. To transfer an Office database object to such a device drag (copy) the object directly to the  **Local Memory** top node. The object specific files will automatically be copied to the appropriate subfolder (e.g. **Projects** will automatically be copied to the **DBX** sub-directory).

Note:

- To change the pre-defined directory structure of the local memory device select [Settings...](#) from the context menu and choose between **SmartWorx Viva**, **System 1200/ GPS900** (CF-cards), **GPS500** (PC-cards) and **TPS1100/DNA** (PC cards).
- In the Settings dialog you can also specify for which instrument class **field data objects** shall be created. By default the same instrument class is selected as chosen under **Local memory device setting**.

DXM locations: Serial ports/ USB

The Data Exchange Manager allows for a connection to either the  **USB** port or the  **Serial Ports** ( **COM** ports) of your computer. Depending on the instrument type one or the other type of connection may be used:

The following instruments can be connected to the serial ports:

- System 1200 (GPS and TPS)
- GPS - System 500
- TS 02/06/09
- TS30/ TM30
- TPS - 300, 400, 700, 800, 1000, 1100, RCS 1100, BUILDER
- DNA (DNA 03, DNA 10), SPRINTER

The following instruments can be connected to the USB port:

- Viva series
- RX 1250/ RX 900(CS09)
- TS 02/06/09



To guarantee successful communication make sure that the [COM/ USB Settings](#) suit the connected instrument.





Depending on the kind of instrument one or more of the following memory devices will be found and displayed in the COM/ USB directory of the port to which your instrument is connected:

Internal Memory

Local Memory devices

System Memory

Whereas the **Internal Memory** and the **Local Memory** devices show  **Files** and  **Objects**, the **System Memory** device only shows  **Objects**.

- When you open the  **Files** directory all files stored in the selected memory device are displayed.
- When you open the  **Objects** directory all [downloadable instrument specific objects](#) contained in the respective memory are listed. They are grouped into sub-directories like  **Jobs**,  **Coordinate Systems** etc.

Settings

DXM Settings

Before you start data transfer from your PC to your instrument or to your local memory device select the appropriate transfer settings from the **Settings...** dialog.

1. Open the Data Exchange Manager and select **Settings...** from the context menu.
2. In the Property-Sheet use the tabs to switch between the following pages:
 - General
 - COM/USB Settings
3. Make your changes or press the **Default** button to apply the default settings.
4. Press **OK** to confirm or **Cancel** to abort the function

DXM Settings: General

Before you can execute a successful data transfer from the office software to your instrument or an instrument specific local memory device you have to adapt the following settings:

Local memory device setting:

When you have formatted a local memory device on your instrument then it will have a pre-defined directory structure. Depending on the kind of instrument the directory structure varies. According to the instrument you intend to use the local memory device with you may choose between different local memory devices from the combo box:

- SmartWorx Viva
- **System1200/ GPS900**
- **GPS500 or**
- **TPS1100/ DNA**

When you transfer database objects to the local memory device the object specific files will automatically be copied to the appropriate subfolder (e.g. **Projects** will automatically be copied to the **DBX** sub-directory for *System 1200* or to the **GeoDB** sub-directory for *GPS500*).

Create field data objects for:

Define which kind of field data objects shall be created during data transfer.
Choose between:

- SmartWorx
- **GPS500**

Since object structure varies for the different systems you have to define for which kind of instrument the field data objects shall be created. This is of special importance if you transfer database objects without using a local memory device (e.g. via cable or to the PC hard disk).

By default the selection for this combo box is set according to the selection under **Local memory device setting**. You may choose a different system, though. For TPS1100/ DNA no field data objects can be created.

Note:

- The following restrictions apply to the transfer of codelists because the instrument type is already part of the codelist definition:
 1. **Transfer to a local memory device:**
Only codelists of type SmartWorx may be transferred to a SmartWorx field object and only codelists of type GPS500 may be transferred to a GPS500 field object.
 2. **Transfer to hard disk:**
The codelist is created (=copied) according to its defined type. The **Create field data objects for** setting will be ignored.

Recognized files:

The following recognized files (i.e. files recognized as objects) are detected in the user-defined search path on the PC:

- **Format files**
- **Geoid model field files**
- **CSCS model field files**
- **Road jobs** (SmartWorx only)
- **DTM jobs** (SmartWorx only)
- **Configuration sets** (SmartWorx only)

They are displayed as Office database objects under the **My Computer - Objects** node.

Search in:

The search path points to the directory on your hard disk where Geoid Model Field Files (*.GEM),

CSCS Model Field Files (*.CSC) and Format Files (*.FRT) are stored. To change the search path enter a new path or browse  to the desired directory.

Include subfolders:

If your database objects are stored in different sub-directories of the specified Search Path, check this box to search them all.

Tip:

- To avoid long search times try and save your Geoid Model Field Files, your CSCS Model Field Files and your Format Files all in one place on your hard disk. This means, have one directory somewhere on your hard disk which contains the sub-directories for *.GEM Files, *.CSC Files and *.FRT Files.

DXM Settings: COM/USB Settings

This Property Sheet enables you to set the Communication Options for the serial or the USB port.

1. In the left-hand tree-view select **Settings...** from the context menu.
2. In the **COM/USB Settings** page make your changes as described below or press the **Default** button to apply the default settings.
3. Press **OK** to confirm or **Cancel** to abort the function.

Port:

Select the USB port or the serial communication port of your computer to which the instrument is connected.

Instrument:

Select the instrument which is connected to the serial port or the USB port.

Baud rate:

Select the baud rate at which data shall be transferred. If you experience problems with the data transfer, you may need to select a lower baud rate.

Make sure that the selected baud rate corresponds to the baud rate set on your instrument.

Note: For GPS 500 and GPS 1200 the baud rate is automatically detected to correspond to the baud rate selected on the instrument.

For certain TPS instruments it is important to set some of the following parameters correctly:

Parity:

Select the parity needed for data transfer. The parity may be either **None**, **Even** or **Odd**. If the parity is not hardwired for the instrument connected to the COM/ USB port it may be manually selected. Make sure that the selected parity corresponds to the parity set on your instrument.

Stop bits:

Select the stopbits needed for data transfer. The stopbit(s) signalize(s) the end of a block of databits. If the number of stopbits is not hardwired for the instrument connected to the COM/ USB port it may be manually selected. Make sure that the selected number of stopbits corresponds to the number of stopbits set on your instrument.

Data bits:

Select the databits to be transferred in a block. A block of databits may consist of either 7 or 8 databits. If the number of databits is not hardwired for the instrument connected to the COM/ USB port it may be manually selected. Make sure that the selected number of databits corresponds to the number of databits set on your instrument.



End mark:

Select the marker which signalizes the end of a data string (i.e. a string of databits and stopbits). The endmark can be either CR or CRLF. If the endmark is not hardwired for the instrument connected to the COM/ USB port it may be manually selected. Make sure that the selected endmark corresponds to the endmark set on your instrument.

Press the **Default** button to restore the defaults for the connected instrument.



Upload/ Download

Uploading objects to the instrument

The Data Exchange Manager component can be used for transferring objects from the database to the Instrument (Upload). You can either transfer objects to the  **Local Memory** drive of your PC or use  **Serial communication**. Data exchange with SmartWorx Viva and with RX1250 instruments is established via the  **USB** port of your computer using **ActiveSync**.

Additionally, you can transfer database objects to a place on your hard disk. The objects specific files can then manually be copied to the appropriate folder on your local memory device. For further information on the directory structure of the local memory device refer to the **Technical Reference Manual** of your instrument.

To transfer objects onto the local memory device:

1. In the right-hand side tree-view of the Data Exchange Manager open the  **Objects** folder of the  **My Computer** location and select the object you want to transfer.
2. Drag and Drop the object onto the  **Local Memory** node in the left-hand side tree-view. Alternatively, select Copy and Paste from the context menu.
3. The object is transferred automatically to the appropriate sub-directory on the local memory device. If the sub-directory does not already exist, it will be created.







To transfer objects via serial communication/ USB to the instrument:

1. Connect your instrument to the serial/ USB port of your computer using the data-transfer cable.

With *GPS 1200* instruments you have to ensure that the data-transfer cable is attached to a port which is not currently configured to any other interface (such as Real-Time or NMEA).

With *GPS 500* instruments you have to ensure that the data-transfer cable is attached to the port which is currently assigned to the remote interface.

Note: On how to configure a port on the GPS 1200 or GPS 500 instruments, please, refer to the corresponding Technical Reference Manual.



2. Ensure that the **Settings** for the port are correct.
3. In the right-hand side tree-view of the Data Exchange Manager open the  **Objects** folder of the  **My Computer** location and select the object you want to transfer.
4. In the left-hand side tree-view open the  **USB** or the  **COM port** node to which your instrument is connected.
5. Drag and Drop (Copy and Paste) the object from the right-hand side **Objects** folder to the appropriate memory device (e.g. to the  **Local memory** folder) in the left-hand side tree-view. You may also drop (paste) the object directly to the appropriate sub-folder, e.g. a project to the  **Jobs** folder.

Note:

- *Projects, Coordinate Systems, Antenna definitions or Codelists* can also be transferred out of the corresponding **Management components** to the **Hard Disk...** or a **Local memory device**. Right-click on the object to be transferred and select **Send to** from the context menu.
- Transferring objects from and to the instrument via data-transfer cable is generally slower than using a local memory device. Use the data-transfer cable only if you do not have a local memory device installed.

- The connection with SmartWorx Viva or with the RX1250 (or RX900) is established using **ActiveSync**. Connect the instrument to the **USB** port of your computer and ensure that the firmware is running. Also ensure that the ActiveSync and the USB driver are correctly installed.

Downloading objects from the instrument





The Data Exchange Manager component can be used for transferring objects from the Instrument to the hard disk of your PC (Download) using  **Serial communication**. Data exchange with SmartWorx Viva and with RX1250 instruments is established via the  **USB** port of your computer using **ActiveSync**.

To transfer objects via serial communication/ USB from the instrument to the PC:

1. Connect your instrument to the serial/ USB port of your computer using the data-transfer cable.

With *GPS 1200* instruments you have to ensure that the data-transfer cable is attached to a port which is not currently configured to any other interface (such as Real-Time or NMEA).



With *GPS 500* instruments you have to ensure that the data-transfer cable is attached to the port which is currently assigned to the remote interface.

Note: On how to configure a port on the GPS 1200 or GPS 500 instruments, please, refer to the corresponding Technical Reference Manual.
2. Ensure that the **Settings** for the port are correct.
3. In the left-hand side of the tree-view open the  **USB** or the  **COM port** node to which your instrument is connected and select the object you want to transfer. Objects can be copied from any of the sub-directories in the  **Objects** directory of either the Local memory or the Internal memory or the System memory device.
4. In the right-hand side tree-view of the Data Exchange Manager open the  **Files** folder of the  **My Computer** location and select the sub-directory where you want to transfer the object to.
5. Drag and Drop (Copy and Paste) the object from the left-hand side **Objects** directory of any of the memory devices to the **Files** sub-directory selected in the right-hand side tree-view. All object specific files will be copied to the selected directory on your hard disk.

Note:

- Objects cannot be copied directly to the **Objects** folder of the **My Computer** location. Make use of the corresponding **Import** tool to convert the instrument data into an Office database **Object**.
- Jobs are never stored in the System memory. Thus, Jobs can only be downloaded from a Local Memory device or the Internal Memory to your PC. All other objects can be downloaded from either the Local Memory device or the **System Memory** (or the Internal Memory for SmartWorx Viva).
- Transferring objects from and to the instrument via data-transfer cable is generally slower than using a local memory device. Use the data-transfer cable only if you do not have a local memory device installed.
- The connection with SmartWorx Viva and with the RX1250 (or RX900) is established using **ActiveSync**. Connect the instrument to the **USB** port of your computer and ensure that the firmware is running. Also ensure that the ActiveSync and the USB driver are correctly installed.

Uploading files to the instrument

The Data Exchange Manager component can be used for transferring files from the hard disk of your PC to the Instrument (Upload) using  **Serial communication**. Data exchange with SmartWorx Viva and RX1250 (or RX900) instruments is established via the  **USB** port of your computer using **ActiveSync**.







To transfer files via serial communication/ USB to the instrument:

1. Connect your instrument to the serial/ USB port of your computer using the data-transfer cable.

With *GPS 1200* instruments you have to ensure that the data-transfer cable is attached to a port which is not currently configured to any other interface (such as Real-Time or NMEA).

With *GPS 500* instruments you have to ensure that the data-transfer cable is attached to the port which is currently assigned to the remote interface.



Note: On how to configure a port on the GPS 1200 or GPS 500 instruments, please, refer to the corresponding Technical Reference Manual.

2. Ensure that the **Settings** for the port are correct.
3. In the right-hand side tree-view of the Data Exchange Manager open the  **Files** folder of the  **My Computer** location and select the file you want to transfer.
4. In the left-hand side tree-view open the  **USB** or the  **COM port** node to which your instrument is connected and open the appropriate memory device sub-folder. Files can only be copied to a directory in the  **Files** directory of either the Local memory or Internal memory device.
5. Drag and Drop (Copy and Paste) the file from the right-hand side **Files** folder to the selected sub-folder of either the  **Local Memory** or  **Internal Memory** device in the left-hand side tree-view.

Note:

- Files cannot be transferred to the System Memory. Only objects can be uploaded directly to the System Memory device.
- Transferring files from and to the instrument via data-transfer cable is generally slower than using a local memory device. Use the data-transfer cable only if you do not have a local memory device installed.
- The connection with the SmartWorx Viva and the RX1250 (or RX900) is established using **ActiveSync**. Connect the instrument to the **USB** port of your computer and ensure that the firmware is running. Also ensure that the ActiveSync and the USB driver are correctly installed.
- If a DXF file is to be transferred to a TS 02/06/09 instrument the **DXF Filter Dialog** comes up in which you have to **Select the (DXF) layers to be imported** and to define a **Prefix name** that shall be added as a Point Id to points coming from DXF without having their own Point Id. You may choose to **get the Point Id from the DXF attribute**, if available. For Lines and Blocks you may select to **include** Line Points and/ or Block Points. Further, you can **exclude** specific **heights** from the upload, which makes points having this specific height being converted to 2D points.

Downloading files from the instrument

The Data Exchange Manager component can be used for transferring files from the Instrument to the hard disk of your PC (Download) using  **Serial communication**. Data exchange with SmartWorx Viva and RX1250 (or RX900) instruments is established via the  **USB** port of your computer using **ActiveSync**.





To transfer files via serial communication/ USB from the instrument to the PC:

1. Connect your instrument to the serial/ USB port of your computer using the data-transfer cable.

With *GPS 1200* instruments you have to ensure that the data-transfer cable is attached to a port which is not currently configured to any other interface (such as Real-Time or NMEA).

With *GPS 500* instruments you have to ensure that the data-transfer cable is attached to the port which is currently assigned to the remote interface.

Note: On how to configure a port on the GPS 1200 or GPS 500 instruments, please, refer to the corresponding Technical Reference Manual.



2. Ensure that the **Settings** for the port are correct.
3. In the left-hand side of the tree-view open the  **USB** or the  **COM port** node to which your instrument is connected and select the file you want to transfer. Files can only be copied from a directory in the  **Files** directory of either the Local memory or Internal memory device.
4. In the right-hand side tree-view of the Data Exchange Manager open the  **Files** folder of the  **My Computer** location and select the sub-directory where you want to transfer the file to.
5. Drag and Drop (Copy and Paste) the file to the selected sub-directory on your hard disk.

Note:

- Files can only be transferred to the **Files** directory of the **My Computer** location.
- Transferring files from and to the instrument via data-transfer cable is generally slower than using a local memory device. Use the data-transfer cable only if you do not have a local memory device installed.
- The connection with SmartWorx Viva and with the RX1250 (or RX900) is established using **ActiveSync**. Connect the instrument to the **USB** port of your computer and ensure that the firmware is running. Also ensure that the ActiveSync and the USB driver are correctly installed.

Import/Export Backup

Via the Import/ Export Backup functionality you can create a backup of the complete data (including Jobs, Road jobs, Format files, Codelists and Configurations sets) contained in your TS02/06/09 instrument.

1. Connect your instrument to LGO via COM port.
2. In the left side of the Data Exchange Manager open the  **Serial Ports** node and then the  **COM port** node to which your instrument is connected.
3. When the instrument is recognized right-click and select **Import/ Export Backup** from the context menu.
4. In the **Import/ Export Backup** dialog select a directory to which or from which the backup shall be written or read.

Importing a backup guarantees that the complete data content of your instrument is restored to the status it had when the backup was created (exported).



Send To

Database objects such as *Projects*, *Coordinate Systems*, *Antenna definitions* or *Codelists* can be transferred to the instrument using the [Data Exchange Manager](#). Additionally, these database objects may be sent out of the corresponding **Management components** to the **Hard Disk** or a **Local memory device**.

To transfer objects onto a local memory device:

1. Make sure that the local memory device drive letter is set correctly under [Options: General](#).
2. In the Tree-View or the Report-View right-click on the  object to be transferred.
3. Select **Send To** and then **Local memory device** from the context menu.

The selected object is sent directly to the appropriate subdirectory on the local memory device. If this subdirectory does not already exist, it will be created.

In the active project a selection of **Points** and/ or complete geometry objects (**Lines/ Areas**) may be sent out of  **View/Edit** or out of the  **Points** tab to the **Hard Disk** or **Local Memory device**.

To transfer points/ geometry objects to the local memory device:

1. Make sure that the local memory device drive letter is set correctly under [Tools - Options: General](#).
2. In **View/ Edit** or in the **Points** tab select the points to be send to the local memory device. If you want to transfer geometry objects like lines or areas make sure the entire object is selected.

Note: If you want to **exclude de-activated** points from being sent you may go to the **Points** View and select **Select checked items** from the context menu. Only active (checked) points will be selected. After that select **Send to** to send all active points.

3. Select **Send To** and then **Local Memory device** from the background/ context menu.

The selected points/ geometry objects are sent directly to the appropriate subdirectory on the local memory device. If this subdirectory does not already exist, it will be created.

Note:

- Alternatively, you may select **Send to Hard Disk**. Be aware that then you have to manually select the appropriate folder on your local memory device. For further information on the directory structure of the local memory device refer to the **Technical Reference Manual** of your instrument.
- Since the object structure varies for SmartWorx and System 500 you have to decide whether you want to create the object for or send the selection of points/ objects to a SmartWorx instrument or to a System 500 sensor.

Codelists are inherently instrument specific. Thus, you need not specify the System when you send codelists to a local memory device or to the hard disk. See: [Create a new Codelist](#) for further information.

- For *SmartWorx Viva* instruments **Projects** sent to the **Local memory device** will be written into separate sub-folders if **for SmartWorx Viva** is selected. The same happens if you select **Send to Hard disk for SmartWorx Viva...**
- Data transfer via cable may only be managed in the [Data Exchange Manager](#). You may not transfer **Projects**, **Coordinate Systems**, **Antennas** or **Codelists** out of their **Management components** to the instrument via cable.



Related Topics:



Transfer objects of the Office database

Uploading objects to the instrument

Transfer objects

Transfer Objects of the Office database

The  **Objects** folder of the  **'My Computer'** location lists the loadable objects of the Office database which can be uploaded to the instrument.

Upload is possible to the  **Local Memory** location (i.e. to the SD-/CF-/PC-card drive of your PC or to a USB stick) or via serial communication to the  **Serial Ports** location.

The following objects can be uploaded from the Office database:

Projects

Coordinate Systems

Antennas

Codelists

Additionally, the following types of files are **recognized** as objects if they are found in the **search path of the PC settings**:

Format files

Geoid model field files

CSCS model field files

Road jobs **



DTM jobs **

Configuration sets

For some of the database objects a conversion to the structure used on the instrument is necessary. This is done automatically during transfer.

Objects marked with **are only available with SmartWorx instruments.





Note:



- Database objects can also be transferred to a place on your hard disk. You may copy them to a directory in the  **Files** folder of the  **'My Computer'** location. As a result you get the single object specific files copied to the specified location. These files (e.g. those making up a job) can then manually be copied to the corresponding folder on the local memory device of your instrument.

To learn more about how to proceed when uploading database objects to an instrument refer to:

[Uploading objects to the instrument](#)

Transfer Objects of the Instrument

The  Internal Memory or  Local Memory or  System Memory sub-directories of the  **Serial Ports** or the  **USB** location display the objects found on the connected instrument which can be downloaded to the PC.

Objects downloaded to the PC via serial communication have to be copied to the  **Files** sub-folder of the  **My Computer** location. Direct import to the database ( **Objects** sub-folder) is not supported. To import data to the Office database run the corresponding **Import** routine.

The following objects can be downloaded from the instrument:

Jobs

Coordinate Systems

Antennas

Codelists

Geoid model field files

CSCS model field files

For *SmartWorx* instruments **Format files** are also displayed as objects.

To update the list of objects for the connected instrument select **Refresh** from the context menu



Note:

- Jobs cannot be stored in the System memory.

To learn more about how to proceed when downloading database objects from an instrument to the PC refer to:

Downloading objects from the instrument

Transfer objects: Jobs

Data collected on the instrument is stored in **Jobs**. If you **download a Job** from the instrument to the PC the Raw Data and Points contained in the job as well as the Coordinate System used with the job will be transferred. Select a directory on your hard disk, i.e. a sub-directory in the  **Files** directory of the  **My Computer** location, where the Job shall be copied to. Use the **Import Raw Data** tool then to import the Job data into a **Project** and convert the Job data into an Office database **Object**.



Jobs can either be stored in the instrument's Local Memory device or in the Internal Memory but cannot be transferred to the System Memory.

Transfer objects: Projects

If you **upload a Project** all points of the Project will be stored in a Job on the instrument. A Project is usually transferred to upload stakeout points to the instrument. Projects can be transferred to the Local memory device or to the Internal Memory.



Depending on the selection in the **DXM Settings** dialog you can create jobs for SmartWorx or System 500.

- Only point related information is converted into a job. No raw data is contained in a job created by the Data Exchange Manager. If a coordinate system is attached to the project this coordinate system is automatically included in the job.

If you **download a Job** from the instrument to the PC the Raw Data and Points contained in the job as well as the Coordinate System used with the job will be transferred. Select a directory on your hard disk, i.e. a sub-directory in the  **Files** directory of the  My Computer location, where the Job shall be copied to. Use the **Import Raw Data** tool then to import the Job data into a **Project** and convert the Job data into an Office database  **Object**.

Transfer objects: Coordinate Systems

Coordinate Systems can be transferred from the Coordinate System Management component of LGO to the instrument (and vice versa). They have to be stored in the System Memory to be used on the instrument. For *SmartWorx Viva* they have to be stored in the Internal Memory. All transferred coordinate systems are stored in one file (TRFSET.DAT or GPSTRF.DAT). If the file already exists on the instrument the new Coordinate System will be merged into the existing file.

To transfer the coordinate systems using a local memory device drag (copy) the coordinate system from the  **Objects** folder of the  **My Computer** location to the  **Local Memory** location in the Data Exchange Manager. The coordinate system file will be copied into the correct sub-directory of the local memory device automatically. For SmartWorx the coordinate system file will be copied into the sub-directory \DBX and for GPS System 500 into the sub-directory \GEODB. Select the local memory device type in the [DXM Settings](#).

For SmartWorx the coordinate system information is written to a file TRFSET.DAT, whereas for GPS System 500 a file GPSTRF.DAT is created. Select the System for which you wish to create the coordinate system file in the [DXM Settings](#).

After transferring the coordinate system file to the local memory device use the **Transfer** command on the instrument to copy the file to the System Memory.

Note:

- Coordinate Systems, which include transformation types [Classical 2D](#), [Stepwise](#) or [Interpolation](#) may NOT be uploaded to the instrument.
- Geoid Models included in the Coordinate System are ignored. To upload a Geoid Model to the instrument a [Geoid Model field file](#) has to be created first.
- If a CSCS model is included in a Coordinate System then the CSCS model will be ignored when uploading the Coordinate System to the instrument. To use a CSCS model on the instrument a [CSCS Model Field File](#) has to be created first.
- Coordinate System files (TRFSET.dat or GPSTRF.dat) can be imported back into LGO. For further information refer to: [Import Coordinate Systems](#).



See also:

[Transfer objects: Geoid model field files](#)

[Transfer objects: CSCS model field files](#)

Transfer objects: Antennas



User defined Antenna definitions can be transferred from the global Antenna Management component of LGO to the instrument (and vice versa). They have to be stored in the System Memory to be used on the instrument. For *SmartWorx Viva* they have to be stored in the Internal Memory. The Antenna definitions are stored in the file LIST.ANT.

To transfer the antenna information using a local memory device drag (copy) the antenna from the  **Objects** folder of the  **My Computer** location to the  **Local Memory** location in the Data Exchange Manager. The file LIST.ANT will be copied into the sub-directory \GPS of the local memory device. Use the **Transfer** command on the instrument then to copy the file to the System Memory.

Transfer objects: Codelists

Codelists stored in the global Codelist Management component can be transferred to the instrument (and vice versa). They have to be stored in the System Memory to be used on the instrument. For *SmartWorx Viva* they have to be stored in the Internal Memory.

Note that the file structure of the stored codelist depends on the instrument type for which the codelist is defined.

To transfer the codelist using a local memory device drag (copy) the codelist from the  **Objects** folder of the  **My Computer** location to the  **Local Memory** location in the Data Exchange Manager. For SmartWorx and for GPS System 500 the codelist file(s) will be copied into the sub-directory \CODE of the local memory device. Use the **Transfer** command on the instrument then to copy the codelist to the System Memory.

Note:

- Because the instrument type is already part of the codelist definition the following restrictions apply to the transfer of codelists:



The codelist is created (=copied) according to its defined type. Only codelists of type SmartWorx may be transferred to a SmartWorx field object and only codelists of type GPS500 may be transferred to a GPS500 field object.

It might be necessary to adapt the [transfer settings](#) accordingly.

Transfer objects: Format files

Format Files are created in the Format Manager. They have the extension *.FRT.

Format Files have to be stored in the System Memory to be used on the instrument. For *SmartWorx Viva* they have to be stored in the Internal Memory.

To transfer a Format File using a local memory device drag (copy) the file from the  **Objects** folder of the  **My Computer** location to the  **Local Memory** location in the Data Exchange Manager. The *.FRT file will be copied to the sub-directory `\CONVERT` of the local memory device (for SmartWorx and GPS System 500). Use the **Transfer** command on the Sensor then to copy the file to the System memory.



Note:

- Only those Format Files found in the **Search Path** of the **PC Settings** are listed in the corresponding sub-directory of the **My Computer - Objects** folder. Format Files stored in a different directory are not listed.

Transfer objects: Geoid model field files

Geoid Model **Field Files** may be extracted from an LGO Geoid Model. Each Geoid Field File is stored in files with the extension *.GEM. For more information see [Create Geoid Model field file](#).

Geoid Model Field Files can be stored in the System Memory (in the Internal memory for *SmartWorx Viva*) or in a local memory device to be used on the instrument.

To transfer a Geoid Model Field File using a local memory device drag (copy) the field file from the  **Objects** folder of the  **My Computer** location to the  **Local Memory** location in the Data Exchange Manager. The *.GEM file will be copied to the sub-directory \DATA\GPS\GEOID on the local memory device. Use the **Transfer** command on the instrument then if you wish to copy the file to the System memory.



Note:

- Only those Geoid Model Field Files found in the **Search Path** of the [PC Settings](#) are listed in the corresponding sub-directory of the **My Computer - Objects** folder. Field Files stored in a different directory are not listed.
- Geoid Model Field Files may require considerable disk space. The System Memory is limited in size depending on the number of other objects stored. Create a smaller Field File or directly access the file from the local memory device if necessary.

Transfer objects: CSCS model field files

CSCS Model **Field Files** may be extracted from an LGO CSCS Model. Each CSCS Field File is stored in a file with the extension *.CSC. For more information see [Create CSCS Model field file](#).

CSCS Model Field Files can be stored in the System Memory (in the Internal memory for *SmartWorx Viva*) or in a local memory device to be used on the instrument.



To transfer a CSCS Model Field File using a local memory device drag (copy) the field file from the  **Objects** folder of the  **My Computer** location to the  **Local Memory** location in the Data Exchange Manager. The *.CSC file will be copied to the sub-directory \DATA\GPS\CSCS on the local memory device. Use the **Transfer** command on the instrument then if you wish to copy the file to the System memory.

Note:

- Only those CSCS Model Field Files found in the **Search Path** of the [PC Settings](#) are listed in the corresponding sub-directory of the **My Computer - Objects** folder. Field Files stored in a different directory are not listed.
- CSCS Model Field Files may require considerable disk space. The System Memory is limited in size depending on the number of other objects stored. Create a smaller Field File or directly access the file from the local memory device if necessary.

Transfer objects: Configuration sets

Configuration sets for System 1200 instruments can be created with the **System 1200 Simulator** and have to be stored in the System memory to be used on the instrument.

To transfer configuration sets using a local memory device drag (copy) the files from the  **Objects** folder of the  **My Computer** location to the  **CF-card** location in the Data Exchange Manager. The configuration sets will be copied to the sub-directory \CONFIG of the local memory device. Use the **Transfer Objects** command from the **Tools** main menu on the instrument then to copy the files to the System memory.

Note:



- Only those configuration sets found in the **Search Path** of the **PC Settings** are listed in the corresponding sub-directory of the **My Computer - Objects** folder. Configuration files stored in a different directory are not listed.
- Configuration files for *GPS500* or *TPS1100* can be uploaded with the **Software Upload** tool. Please refer to:

Software Installation - Configuration Files (GPS500)
Software Installation - Configuration (TPS1100)

Transfer objects: Road jobs (SmartWorx)

Road jobs are created with the **Design to Field** component and can be used on SmartWorx instruments.

Road jobs have to be stored in the *DBX* directory of the local memory device to be used on the instrument.

To transfer a Road job using the local memory device drag (copy) the job files from the  **Objects** folder of the  **My Computer** location to the  **Local Memory** location in the Data Exchange Manager. The job files will be copied to the sub-directory *DBX* of the local memory device.



Note:

- Only those Road job files found in the **Search Path** of the **PC Settings** are listed in the corresponding sub-directory of the **My Computer - Objects** folder. Road job files stored in a different directory are not listed.

Transfer objects: DTM jobs (SmartWorx)

DTM jobs are created with the **Design to Field** component and can be used on SmartWorx instruments.

DTM jobs have to be stored in the *DBX* directory of the local memory device to be used on the instrument.

To transfer a DTM job using the local memory device drag (copy) the job files from the  **Objects** folder of the  **My Computer** location to the  **Local Memory** location in the Data Exchange Manager. The job files will be copied to the sub-directory *DBX* of the local memory device.

Note:

- Only those DTM job files found in the **Search Path** of the **PC Settings** are listed in the corresponding sub-directory of the **My Computer - Objects** folder. DTM job files stored in a different directory are not listed.

Software Upload

Software Upload



The Software Upload Tool enables you to load firmware and applications via the [Software Installation Wizard](#) to:

- System 1200 instruments (GPS 1200, TPS 1200, RX 1200)
- TS30/ TM30
- GPS System 900 instruments (CS09/ RX900)
- GPS System 500 instruments
- TPS 1000/ 1100 instruments
- RCS 1100 instruments
- TPS 300/ 400/ 700/ 800/ BUILDER instruments
- TS02/06/09
- DNA instruments

To ensure a successful upload:

1. Connect the instrument to one of the serial ports of your PC. RX1250 (or RX900) instruments have to be connected to the USB port of your PC. TPS instruments have to be switched off before you start with the Software Upload procedure.
2. Check the power supply of the instrument.
3. In the Wizard select the correct Instrument class and Connection.
4. The communication settings on the PC will be set according to the communication settings on the selected instrument. No manual interaction is required.

For System 1200 instruments (GPS or TPS) note that in case the Software Upload cannot be completed successfully and you can no longer communicate with the instrument, please, copy the Sensor Firmware manually into the \SYSTEM folder of the CF-card, insert the card and switch the instrument off and on again.

Internal Memory

The Internal Memory is an optional built-in data storage device. It is available with various file sizes. Data can be transferred from the internal memory to the PC and vice versa by using the data-transfer cable.

Alternatively, data may be copied to the local memory device of the Instrument and from there to the PC by using an appropriate device reader.

For SmartWorx Viva instruments the Internal Memory comprises a system memory, which implies that system files such as Firmware or Language files are also stored in the internal memory. The internal memory of SmartWorx Viva instruments can additionally be used to store Antennas, Coordinate Systems, Codelists, Geoid and CSCS Field Files or Format files etc. These files and objects can be transferred from and to the SD-card by using the Transfer command on the instrument or from and to the PC by using a data-transfer cable.

System Memory

The System Memory is the built-in system storage device. It is used to store the system files such as Firmware or Language files. Additionally, it can be used to store Antennas, Coordinate Systems, Codelists, Geoid and CSCS Field Files or Format files etc. These files and objects can be transferred from and to the local memory device or Internal memory by using the Transfer command on the instrument or from and to the PC by using a data-transfer cable.

For SmartWorx Viva instruments the system memory is integrated into the Internal memory.

Local memory devices

Local memory devices may be either **USB sticks**, **SD-cards** (for SmartWorx Viva), **CF-cards** (for System 1200) or **PC-cards** (available with various capacities for GPS500, TPS1100 and DNA instruments). Data can be transferred from these devices to the PC and vice versa using the data-transfer cable or by using an attached or built-in device reader.

Software Installation Wizard

The Software Installation Wizard is a combined utility tool for uploading firmware and software to any of the supported instruments.

- Invoke the Software Installation Wizard by selecting **Software Upload** from the **Tools** main menu or

by clicking the Software Upload icon  in the **Tools** List Bar.

The wizard comprises of the following steps:

Software Installation Wizard - Select Instrument class and Connection

Software Installation Wizard - Select Software Type

Software Installation - Sensor/ System Firmware

Software Installation - Current Selection

Software Installation Wizard - Select Instrument class and Connection

Before you enter the Software Installation procedure you have to:

- Select the Instrument to which you want to upload firmware or other software.
- Select the Connection (COM port or USB) to which your instrument is connected on the PC.

Note:

- With GPS 1200 instruments you have to ensure that the serial cable is attached to a port which is not currently configured to any other interface (such as Real-Time or NMEA).

With GPS 500 instruments you have to ensure that the serial cable is attached to the port which is currently assigned to the remote interface.

On how to configure a port on the GPS 1200 or GPS 500 instruments, please refer to the corresponding Technical Reference manual.

- Direct serial software upload with the RX1220 is performed at a baud rate of 115kB. It is known that in some cases COM ports can have difficulty with this baud rate. If you are unable to serial upload the terminal firmware to the RX1220, please try with an alternative COM port.
- The connection with the RX1250 (or CS09/ RX900) is established using **ActiveSync**. Connect the instrument to the USB port of your computer and ensure that the firmware is running. Also ensure that the ActiveSync and the USB driver are correctly installed.

After you have selected the instrument and connection you may either:

- Press the **Upload** button to load firmware and/ or applications to the selected instrument via the wizard. You will be forwarded to [Select a Software Type](#).

or:

- Press the **Management** button to view and modify the applications on the selected instrument. You will be forwarded to the [View Applications and System](#) dialog.

Note:

- The **Management** button is only active for TPS1000, TPS 1100 and RCS 1100 instruments.

Software Installation Wizard - Select Software Type

Depending on which Instrument Class you have chosen in the introductory page of the Software Installation wizard you may upload different additional software components:

For System 1200 (GPS 1200, TPS 1200, RX1220, RX1250), TS30/ TM30 and GPS900 (CS09, RX900):

[System Firmware](#)

System Language

Applications

License Key

For GPS 1200 the System Firmware for the **RX1210** Terminal can also be uploaded. The Terminal has to be connected to the GPS instrument then.

For **RX1220** Terminals only System Firmware can be uploaded.

For **RX1250** and **CS09/ RX900** instruments you cannot select to upload System Language, Applications or License Keys together with the System Firmware.

For GPS 500:

For GPS 500 you can either install **Sensor Firmware** or **Other Sensor Software**. Make your choice via the corresponding radio buttons and click **Next** to proceed in the wizard. If you select **Sensor Firmware** you will be forwarded directly to [Software Installation - Sensor/ System Firmware](#). If you select **Other Sensor Software**, you can select to upload:

Terminal Firmware

Language files

Configuration Files

Character Sets

For TPS 1000/ 1100:

[System Firmware](#)

System Language

EDM Firmware

ATR Firmware

PowerSearch Firmware

Applications

Configuration

For TPS 300/ 400/ 700/ 800/ BUILDER, TS02/06/09:

For TPS400, TPS800, BUILDER and TS02/06/09 instruments you will upload the first language together with the System Firmware. A second language can then be uploaded additionally.

If you select **Only Languages** you can upload only the languages or add a new second language to the instrument.

[System Firmware & Languages](#)

[Only Languages](#)

EDM Firmware

ATR Firmware (not available for TPS300, TPS400, TPS800, BUILDER and TS02/06/09)

Onto the **RCS 1100** and onto the **DNA** only **System Firmware** may be uploaded. If you select one of these instruments in the **Select Instrument and Connection** page you will be forwarded directly to **Software Installation - Sensor/ System Firmware**.

To return to the **Select Instrument and Connection** page, select **Cancel**.

To upload software components proceed as follows:

1. Select the Software components you want to install. You may select more than one component at the same time.
2. Click **Next** to proceed. If you have selected more than one component you will be guided through a series of steps. For each component you will enter a separate installation step. With each step you have to:
3. Select the directory where the special component is stored. This will normally be your Release CD.
4. Select the specific files of each component to be installed.

Only when you have specified the files for each selected component will you be forwarded to view your **current selection**.

Software Installation - Sensor/ System Firmware

The System Firmware is the instrument operating system. To upload System Firmware to your instrument:

1. Browse  to the directory where the firmware is stored. This will normally be on your Release CD.
2. In the **Choose Location** dialog select your CD drive and go to the directory that contains the firmware file(s).
3. When you have specified the location click **OK** to return to the wizard.
4. Back in the **Sensor/ System Firmware** page all firmware files found in the selected directory are listed
5. Select the Sensor/ System Firmware you want to install. For a description of the files and their specific content see the corresponding Release Notes.
6. Click **Next** to view your **current selection**.

Note:

- To upload the System firmware for System 1200 using the CF-card, copy the file into the `SYSTEM` directory on the PC-card and then go to **Upload System Files** in the **Tools** main menu on the instrument to copy the file into the System memory.
- For TPS System 1200 the System Firmware is just one file (TPS1200.fw) and includes EDM, ATR and Power Search firmware .
- For GPS System 1200 the System Firmware is also just one file (GPS1200.fw).
- The System 1200 Terminals (RX1210 and RX1220) have their own firmware. The filename is RX1200.fw and is the same for the GPS Terminal (RX1210) and for the RCS Terminal (RX1220). It includes all texts for local languages.
- For the RX1250 and for CS09/ RX900 instruments the System Firmware is also just one file.
- For GPS System 500 the Sensor Firmware may consist of separate files or of a combined package file. Refer to Sensor Firmware (GPS500) for details.
- For TPS400, TPS800, BUILDER and TS02/06/09 instruments you will upload the first language together with the System Firmware. A second language can then be uploaded in an additional step of the wizard. If no second language is required, select the **None Language** in this step.

If you selected to upload **Only Languages** you can upload only the languages or add a new second language to the instrument. To only add a second language select the checkbox to **Skip First System Language**.

Software Installation - Current Selection

Before your system starts installing files on the sensor you may review your current selection of files.

- Click **Back** if you want to change your current selection.
- Click **Finish** to start uploading the selected files to your sensor. Check the power supply of your instrument before you start the upload procedure.

Software Upload: View Applications and System (TPS1000/ 1100, RCS1100)

In the **View Applications and System** dialog you may view and edit the firmware version and additional sensor software that has already been uploaded to your TPS 1000/ 1100 or RCS 1100 instrument.

The dialog comprises of the following four property pages:

General

Language

Applications

Memory

Design to Field

Design to Field

Design to Field is the tool that allows different data types to be converted and prepared for use on-board your instrument. These data types include control points, digital terrain models and road, rail and tunnel design data for use with the **RoadRunner** suite of applications.

Data may be imported using the industry standard formats LandXML or DXF or from a number of additional formats using converters that are available on the Installation DVD, on myWorld or in the downloads area of the Leica Geosystems website.

To start the Design to Field component:

- Select  **Design to Field** from the **Tools** main menu or from the **Tools** List Bar.

Import Type:

Select which type of job you want to create.

Importer:

Select which type of data **Importer** you want to use. In the **Importer Management** decide which importers shall be listed in the **Importer** combo box. New **Importers** can be registered in the **Importer Management**, too.

Manage...:

Starts the **Importer Management** dialog to choose the **Importers** that you would like to use or to register new ones.

Note: Depending on the selected **Import Type** different importers are offered for selection in the **Importer Management**.

Import...:

Choose the data to be converted and start the selected Importer. For most of the Importers you will be guided through the corresponding **Importer** wizard. Afterwards the **Design to Field - Graphical View** opens automatically.

Data converters (Importers) are available for the following SmartWorx job types:

Points, Lines and Areas (PLA) jobs:

The entities (points, lines and areas) imported into this type of job may be displayed as a background map or may be staked out on-board a SmartWorx instrument.

DTM jobs:

In DTM jobs digital terrain models are stored on-board a SmartWorx instrument. Each digital terrain model may be made up of one or more surfaces or layers.

Road jobs:

In Road jobs a collection of two- or three-dimensional lines, known as stringlines, are stored that define a road project for use with the SmartWorx RoadRunner application. In many cases road projects are defined, in addition to their horizontal and vertical alignments, by cross-sections instead of stringlines. In this case, Design to Field converts the cross-sections to stringlines based on the parameters set by the user before storing the data on-board the SmartWorx instrument.

Rail jobs:

Rail jobs are used in conjunction with the SmartWorx RailRunner application. Design to Field allows the horizontal and vertical alignments of each track to be defined as well as the superelevation or cant for each track.

Tunnel job:

Tunnel jobs are used in conjunction with the SmartWorx RoadRunner Tunnel application. Design to Field allows the horizontal and vertical alignments of the tunnel to be defined as well as the design profiles of the tunnel.

To learn more about Design to Field see also:

[Importers](#)

[Importer Management](#)

[Graphical View](#)

[Graphical Settings](#)

[Connection Editor](#)

[Creating an on-board job](#)

[Glossary of Road Terms](#)

Importers

To successfully prepare data for on-board use it has to be converted from a Leica or 3rd party format to an on-board job. The first step is to import the data. **Importers** are available for different data types. In a second step the imported data, for example roading data, will be prepared for on-board use via the **Export** functionality of the [Design to Field: Graphical View](#).

For further information on data import and conversion, please, refer to the **Design to Field User Guide** which is installed automatically and put onto your desktop with the installation of your software.

Importers are available for the following job types:

Road jobs:

Road projects are generally defined by an horizontal and a vertical alignment. The rest of the project may be defined by cross-sections at given intervals along the horizontal alignment or by a series of longitudinal lines known as stringlines.

Design to Field can import both types of road definition, cross-sections and stringlines. Cross-section data is converted to stringlines during the import process since data is stored on-board the SmartWorx instrument in stringline format only.

Stringlines are three-dimensional lines that define an edge of the road model. A stringline model is created from a collection of cross-sections by joining the vertices of each cross-section to the preceding and following cross-section.

Given that a cross-section may have more or less points than the adjacent cross-sections, conflicts may arise when generating stringlines from cross-section data. These conflicts need to be solved in the [Connection Editor](#) before a stringline model can be produced.

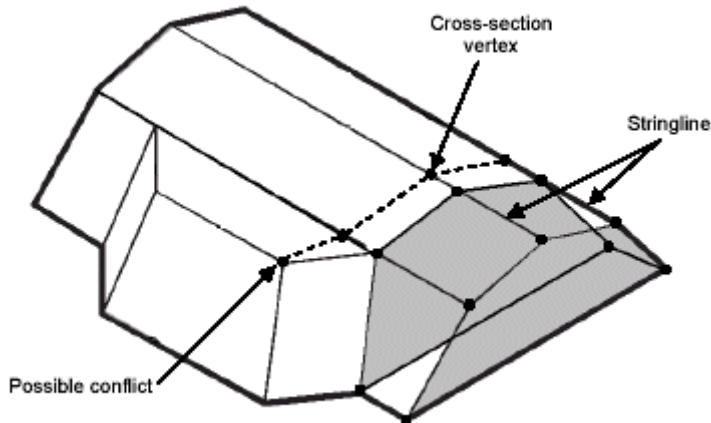

DTM jobs:

Digital terrain models may be imported to SmartWorx for use with the **RoadRunner** suite of applications or with the **Stakeout** application. A SmartWorx DTM job may be created for each digital terrain model file. Each DTM may contain one or more layers on-board the SmartWorx instrument.

Points, Lines & Areas jobs:

The Design to Field Points, Lines and Areas converters allow these graphical entities to be imported to SmartWorx. The imported data may be used as a background map (e.g. for updating purposes) or for staking out. The information imported from each data format is format dependent as not all formats store the same data.

Rail jobs:

Railway tracks are generally defined by at least one horizontal and one vertical alignment. The SmartWorx **RoadRunner Rail** application allows double tracks to be contained within the same job. The Design to Field Rail job converters allow the horizontal and vertical alignment of each track to be imported in the same formats as the Road converters. The rails of each track can be created using the **Rail Editor** application that is installed together with the Rail converters.

Tunnel jobs:

Tunnel jobs are used in conjunction with the SmartWorx **RoadRunner Tunnel** application. Design to Field allows the horizontal and vertical alignments of the tunnel to be defined as well as the design profiles of the tunnel.

Note: Design to Field importers have the file extension *.rri.

Importer Management



The Importer Management allows you to choose **Importers** that you would like to use as well as registering new importers and removing existing ones.

- In the **Design to Field** dialog press the **Manage...** button to access the **Importer Management**.

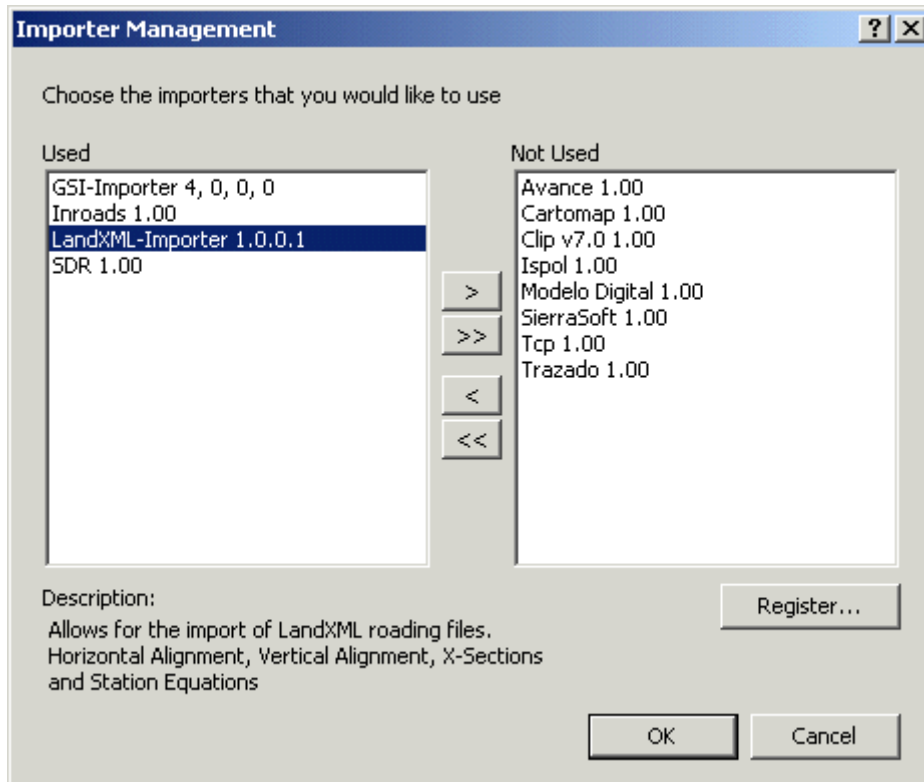
Example:



In the Importer Management:

- Use the  and  buttons to include importers in the **Used** list box. These importers will be available for selection in the **Importer** combo box of the **Design to Field** dialog then. When an importer is selected in the **Used** list box a short **Description** on what the importer does is displayed.
- Use the  and  buttons to shift importers to the **Not Used** list box. To remove an importer from the **Not Used** list box select the importer to be removed, right-click onto it and select **Unregister** from the context menu.
- To add a new importer click on the **Register...** button. Design to Field importers have the extension *.rri. If you try to add an importer that already exists a warning message is issued.

Note:

- According to the selected **Import Type** different **Importers** are offered for selection in the **Importer Management**.
- The **LandXML** and the **GSI Importers** are installed into the same directory that you chose for the installation of the software (i.e. into the [BIN] directory).
- **Importers** for the various other **Import Types** are available on the installation DVD, on myWorld or can be downloaded from the Leica Geosystems website.

Design to Field: Graphical View



The Graphical Viewer and Editor allows data imported from other data formats to be viewed and edited before creating the on-board data files that will be used on your instrument.

The application allows **Points, Lines and Areas** jobs, **Digital Terrain Model** jobs, **Road** jobs, **Rail** jobs and **Tunnel** jobs to be viewed, edited and exported.



The viewer opens in a stand-alone window. The **status bar** at the bottom of the view displays the current mouse coordinates. For Road, Rail and Tunnel job data types the status bar also indicates the **Chainage** and **Offset** of the current cursor position to a selected alignment. A different alignment can be chosen from the combo box. In the view the Offset is drawn as a perpendicular line from the cursor position to the selected alignment.

To switch to the so-called 'Pan'-mode keep the ALT-button pressed. The appearance of the cursor changes to a indicating hand and the displayed area can be moved to the left and right or up and down by clicking with the left mouse button (with the 'hand') into the view and keeping it pressed while moving the cursor.



Using the toolbar buttons you may switch to the following functionality:

- Click the  button or keep the SHIFT-button pressed to **Zoom In**. The background color of the  button changes to blue indicating that the 'Zoom In' mode is active. Click with the left mouse button into the view's background to enlarge and center the area around the cursor or click with the left mouse button into the view's background and keep the mouse button pressed while dragging a rectangle to the lower right-hand-corner of the area you want to enlarge. The content of the rectangle will be enlarged.

Alternatively: Use the mouse wheel to zoom the view in or out.

- Click the  button or keep the CTRL-button pressed to **Zoom Out**. The background color of the  button changes to blue indicating that the 'Zoom Out' mode is active. Click with the left mouse button into the view's background to reduce and center the area around the cursor.

Alternatively: Use the mouse wheel to zoom the view in or out.

- Click the  button to reset the zooming to the view's original size.
- Click the  button to invoke the **Layers** tool. This tool may be used to turn-on or turn-off layers in the graphical view, to include or exclude layers from Export and also to view a single layer of the data. Layers can be renamed by entering the new name in the names field.

When the layer button is pressed, a menu is opened where all of the layers of imported data may be viewed:

Example:

			Hz Ispol
			Taludes
			Subrasante
			Rasante
			Cunetas



Press the buttons to **turn on/ off** specific layers in the graphical view. This button is only used for visualisation purposes. It does not affect whether the data from this layer will be exported to the job.



To select or de-select all layers right-click on the button and invoke the function from the context-menu.



Press the buttons to **include/ exclude** the selected layer from the export to the job.



Press the buttons to view only the selected layer. All layers in the job will be turned-off except for the **selected** layer. This button is only used for visualisation purposes, it does not affect whether the data from this layer will be exported to the job.

- Click the  button to create a **new** layer. This functionality is only available for data based on stringlines. The new layer is added to the list of layers in the 'Active Layer' combo box. It can be renamed by clicking the  button and entering the new name in the names field.





To select an alignment for a specific layer right-click into the background of the view and select a definition from the context menu.

- When displaying jobs based on **stringlines**, you can right-click on a line and use the context-menu to include or exclude a line from the **Export**, to copy or move a line onto another **layer**, to remove a line from the **active** layer, to create **new layers** and to select the line as a **centerline**.

Note, that on each layer a centerline must be defined.

Right-click onto any of the stringlines and select **Properties** from the context-menu to open the **Alignment Properties** dialog for the selected stringline.

The Alignment **Name** and the current value for the **Start Chainage** are given and can be edited. Furthermore, you are given the values for the **End Chainage**, the direction of the tangent in the Start Chainage point (**Segment direction**), the direction of the tangent in the End Chainage point (**End segment direction**) and the count of segments in the selected stringline (**Segment count**). Click the **Opposite direction** button to reverse the stringline direction. The start segment will become the end segment and the segment direction changes by 180°.

- Click the  button to define the **Graphical Settings**.
- Click the  button to open the **Properties** toolbox. It is available for the horizontal and the vertical view. While the toolbox is open you may select single **Elements** of the alignment. The Start and End chainage of the selected element will be listed. Under **Geometry** the geometry type will be given together with its Start and End coordinates (in the horizontal view), its Start and End Height (in the vertical view) and the values of its defining elements.
- Click the  button to switch the view from horizontal to vertical and vice versa. If the vertical view is switched on the vertical profile of the selected alignment will be drawn. A different alignment can be selected from the 'Alignment selected' combo box in the Status bar.
- To view cross-section based data click the  button to launch the **Connection Editor**. When displaying road jobs based on **cross-sections**, you can right-click on a cross-section and use the context-menu to open the Connection Editor for the selected cross-section.
- When converting Tunnel data click the  button to launch the **Tunnel Profile Editor**.
- When you are satisfied with the data, click the **Export** button to **create an on-board job**.
- To save the data back into a LandXML file click the **Save** button. This file may be imported into Design to Field again to continue editing.

Design to Field: Graphical Settings

To view and/ or modify the Graphical Settings of the Graphical view click the  toolbar button to open the **Graphical Settings** dialog.

General:

In the **General** page the **Scale bar** may be switched on or off for display.
Under **Units** the default settings for the angular format and the slope can be defined.

Points:

In the **Points** page the Point Id (**Name**), its **Code**, **Height** and **Description** may be switched on for display.
The arrangement of the additional pieces of information around the point symbol is indicated.

Alignments:

In the **Alignments** page the **Name** of the Alignment, the **Start** points of the elements and the **Chainage texts** may be switched on for display.

Areas:

In the **Areas** page the **Name** of the Area may be switched on or off for display.

Design to Field: Creating an on-board job

When you are satisfied with the data, click the **Export** button to create an on-board job. In the **Export** dialog:

1. Select the **Format** that suits the instrument on which the job to be exported shall be used. Select **Centerline Report**, if you want to create a report of the exported data.
2. Under **Location** browse to the directory where the on-board job shall be written. If you intend to create a report browse to the **Folder** where the text file shall be stored.
3. If you have selected the SmartWorx/ SmartWorx Viva Format enter a job **Name**. Enter a **Filename** if a report shall be stored.
4. Modify the **Settings** if required.

For the export of Road, Rail or Tunnel jobs to the SmartWorx/ SmartWorx Viva format the following settings may be applied:

Allow chainages greater than 214000.0m

Tick this checkbox if you require chainages greater than 214000.0m in the road job. Since System 1200 firmware release 2.10 RoadRunner can use chainages greater than 214000.0m. If this option is ticked the road job will not be compatible with earlier RoadRunner versions.

Chord-Curve Tolerance

When a stringline element cannot be calculated using geometric elements, e.g. a stringline running parallel to a center-line clothoid element, it is approximated by a series of short chords. The tolerance settings of these curves can be manually edited for both the vertical and horizontal components. When converting larger jobs this can result in a smaller Road job.

Note: For the export of Road jobs to the **Roadworks 3D** Format different settings are available.

For the export of Alignment jobs to a Centerline Report the following settings may be applied:

Alignment:

The names of the alignments which are currently selected as centerlines on the different layers are given. Decide on a centerline for which you want a report to be written and select it from the drop-down list.

Start/ End chainage:

The Start and the End chainages of the selected centerline are given. Edit the values if you want the report to be written for for a sub-section.

Increment:

Decide on a increment value that will be applied from the selected Start chainage to the selected End chainage. For each chainage a coordinate will be written to the report. If you select e.g. 10m then every ten meters along the alignment a coordinate will be calculated.

Include tangent points:

Tangent points are the start/ end points of a segment. If you select this option then all segment start/ end points will be included into the report in addition to the increment points.

Include accumulative distance from start chainage:

If you select this option a column called 'LengthT.' will be added to the report into which for each step the accumulated distance is written starting with 0.0m for the selected Start chainage point.

Rotate azimuth by:

Select a value here if you want the azimuth of the calculated points to be rotated by a given amount. In

the report the 'Azimuth' column will be marked with an asterisk to indicate the rotation.

To change the angular format double-click onto the degree symbol. By default, the value set under [Graphical Settings: General](#) will be taken.

Connection Editor

Design to Field: Connection Editor

The Connection Editor allows cross-section based road data to be converted to three-dimensional lines (stringlines) for use on-board SmartWorx instruments.

When cross-section data is imported from the original data files, the cross-section vertices are joined together in order to create stringlines using a series of criteria such as the distance of the vertex from the centerline and the relative position of the vertex along the cross-section.

The stringlines may be viewed and, if required, edited using the Connection Editor.

To invoke the Connection Editor:

- Select the  **Connection Editor** icon from the toolbar of the **Design to Field: Graphical View**. The Connection Editor may only be accessed when importing cross-section based data. The Connection Editor opens in a stand-alone window with a [tri-pane view](#), which visualizes a **Plan view** panel, a **Cross-section view** panel and the **Cross-section data** panel.

At any instance three consecutive cross-sections are displayed. Only cross-sections at chainages that are contained in the original data file are displayed.

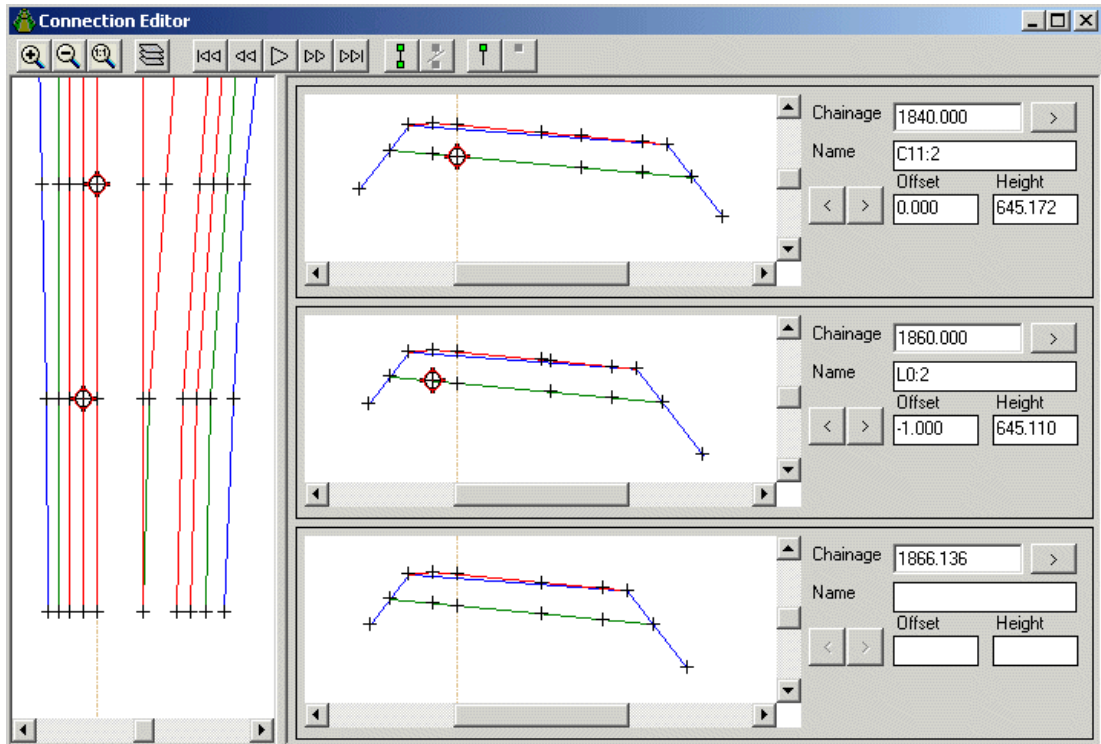

Plan view:

The perspective of the Plan view of the data may be thought of as looking down onto the road design from above with all of the curves in the alignment having been taken away. This view allows a plan perspective of how the vertices of the cross-sections have been joined to create stringlines.

The **Zoom** and **Pan** tools in this view work in the same way as in the **Graphical View** with the exception that the vertical axis of the window is not scaled.

Any cross-section vertex may be selected with a mouse click. The corresponding vertex will also be highlighted in the Cross-Section View.

The status line at the bottom of the view displays the offset from the center line for the cursor position.

Cross-section view:

The Cross-section view allows the cross-section data to be viewed at the chainages that were contained in the original data.

The **Zoom** and **Pan** tools in this view work in all three cross-section views in the same way as in the [Graphical View](#).



Any cross-section vertex may be selected with a mouse click. The corresponding vertex will also be highlighted in the Plan View.

The status line at the bottom of the view displays the offset from the center line and the absolute height for the cursor position.

Cross-section data:

The numeric values of the cross-section data may be viewed in this section. The chainage of the cross-section may be viewed together with the distance from the centerline and the absolute height of the selected vertex.

To rename vertices:

- Press the  button to **show vertex names** in the plan view and in the cross-section view.
- Press the  button to automatically rename all vertices in the selected alignment.
- To rename a range of vertices enter a new **Name** for one vertex in the cross-section data panel and press ENTER. The range of vertices that shall be renamed can be defined in the **Select Chainages** dialog.

The Connection Editor offers the following functionality using the toolbar buttons:

[Selecting layers](#)

[Navigating through cross-sections](#)







[Connecting vertices](#)

Connection Editor: Selecting layers

In the Design to Field **Connection Editor** click the  **Layers** button from the toolbar to invoke the **Layer** tool. The Layer tool is similar in operation to the one in the **Graphical View**. When the layer button is pressed, a menu is opened where all of the layers of the imported data may be viewed.

Example:



- 
 Press the buttons to **turn on/ off** specific layers in the graphical view. This button is only used for visualisation purposes, it does not affect whether the data from this layer will be exported to the SmartWorx job.
To select or de-select all layers right mouse-click on the button and invoke the function from the context-menu.
- 
 Press the buttons to decide whether vertices in the cross-section shall be joined across the centerline or not .
- 
 Press the buttons to view only the selected layer. All layers in the job will be turned-off except for the selected layer. This button is only used for visualisation purposes, it does not affect whether the data from this layer will be exported to the SmartWorx job.
- Press the **Color** buttons to change the color of the selected stringline or to define Custom Colors.

Navigating through cross-sections

The **Navigation** tools of the **Connection Editor** allow each of the cross-sections in the job to be viewed. The following navigation tools are available from the toolbar:



Go to the **first** cross-section in the job



Go to the **last** cross-section in the job



Go to the **previous** cross-section in the job



Go to the **next** cross-section in the job



Play





Stop

The **Play** and **Stop** buttons allow the cross-sections to be viewed one after the other continuously throughout the job. The **Play** button starts the sequence and the **Stop** button stops the sequence.

You may also use the **Chainage** field in the **Cross-section data** panel to display a cross-section at a given chainage. Enter the chainage of the cross-section to be displayed and press the  arrow key.



To select a vertex:

- A vertex may be selected **graphically** in either the **Plan view** panel or the **Cross-section** panel. Click on the vertex in one of the views. The corresponding vertex will be indicated in the other view, too and the offset from the centerline and the height of the point will be shown in the **Cross-section data** panel.
- To navigate across the cross-section, use the   arrow keys in the **Cross-section data** panel. The selection indicator will be moved from one vertex to the next.
- To move to a given chainage type the chainage into the **Chainage** field in the **Cross-section data** panel and press the  arrow button.

Connecting vertices

The **Connection** tools of the **Connection Editor** may be used to connect or disconnect points in a cross-section if they have been connected erroneously. The following connection tools are available from the toolbar:

To manually connect or disconnect a vertex:

-  To **disconnect** two vertices in adjacent cross-sections, select the required vertex in the middle cross-section and the currently connected vertex in the preceding or following cross-section. The **Disconnect** button will be enabled. Click on the **Disconnect** button to disconnect the two vertices.
-  To **connect** two vertices in adjacent cross-sections, select the required vertex in the middle cross-section and a currently disconnected vertex in the preceding or following cross-section. The **Connect** button will be enabled. Click on the **Connect** button to connect the two vertices.



To manually continue or discontinue a vertex:

In some cases it is required to continue a stringline to the next cross-section instead of joining a vertex to another vertex.



In the following example, the vertices 1, 2 and 4 are connected to the corresponding vertex in the next cross-section whereas the vertex 3 is continued at the same distance and height offset from the centerline.

Example:



-  To continue a vertex to the **next** cross-section the vertex must be **disconnected** from all other vertices. Select the vertex in the middle cross section and press the **Continue** button.
-  To discontinue a vertex that has been continued to the **next** cross-section select the vertex in the middle cross section and press the **Discontinue** button.

To automatically connect or disconnect vertices:

- To automatically  connect or  disconnect all vertices in the cross-section press the buttons from the toolbar. Note that the current connections will be lost.

Glossary of Road Terms

C

Center-line:

The center-line is the line that defines the chainages and direction of the road. It is made up of a **horizontal** and may contain a **vertical** component. The horizontal component defines the position of the center-line on the plane while the vertical component adds height information.

Chainage (also called: Station):

The chainage is the distance of a point along the **center-line**.

Cross-section:

Cutting a group of **stringlines** with a vertical surface orthogonal to the **center-line** shows a cross-section.

[Example:](#)

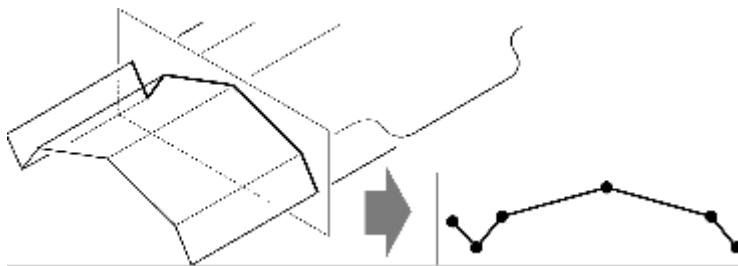

Cross-section, Ahead:

The ahead **cross-section** is the next cross-section along the **center-line** from the current location.

Cross-section, Back:

The back **cross-section** is the cross-section at the current location.

D

Deflection Tolerance:

The deflection tolerance is the tolerance value used for determining deflection errors. A deflection error occurs when the start tangent of an element does not match the end tangent of the previous element.

I

Interpolation:

Connects **vertices** from one **cross-section** to vertices on the next cross-section.

L

Layers:

A road generally consist of layers made of different materials (e.g. road surface of asphalt, layers of different gravel and so on). RoadRunner allows you to display groups of **vertices** in layers.

[Example:](#)

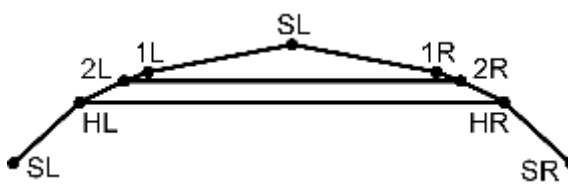

S

Station Equations:

Station equations are used to represent changes (either overlaps or gaps) in the **chainage** of a **center-line**.

Stationing Tolerance:

The maximum allowable distance between the station and the actual distance along the **center-line**.

Stringlines:

Connecting the **vertices** of cross-sections on an alignment creates a series of lines representing the three dimensional design of the road. Such lines defining the design are called stringlines.

[Example:](#)

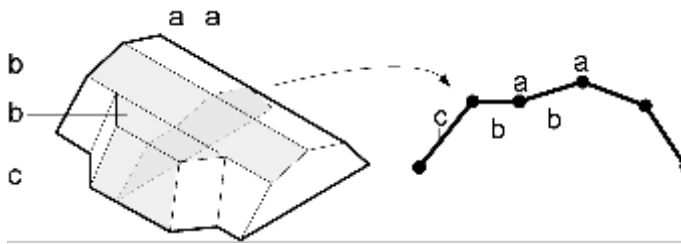

with:

a = point on the stringline

b = 'slope'

c = 'end slope'

V

Vertex:

A vertex is defined as the point of intersection of a **stringline** and the vertical surface orthogonal to the **center-line** defining a **cross-section**.

[Example:](#)

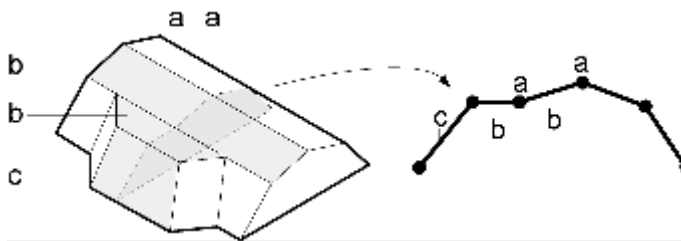

with:

a = point on the stringline

b = 'slope'

c = 'end slope'

Vertex conflict:

A vertex conflict is defined as the **ahead cross-section** being different from the **back cross-section**.

Tunnel Profile Editor

Design to Field: Tunnel Profile Editor



The Tunnel Profile Editor allows you to create SmartWorx onboard data to be used with RoadRunner Tunnel. Using the Tunnel Profile Editor you can attach tunnel profiles to alignment data (the tunnel axis) and store the data as a *.tpe file or a LandXML file. Design To Field allows you to create the RoadRunner Tunnel job to be used on site.

To invoke the Tunnel Profile Editor:

- Press the  **Tunnel Profile Editor** icon in the toolbar of the **Design to Field: Graphical View**. The Tunnel Profile Editor may only be accessed when importing tunnel based data.

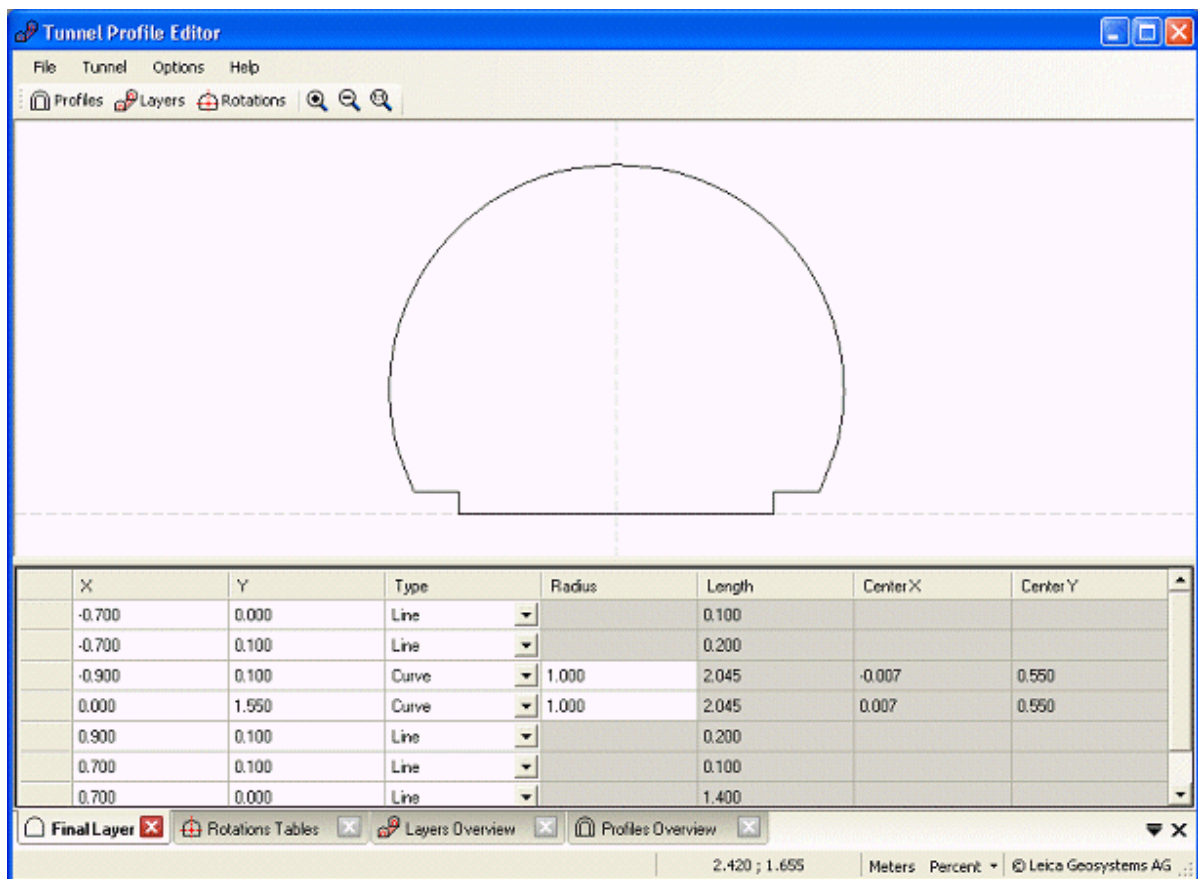
The Tunnel Profile Editor opens in a stand-alone window with a **two-pane view**, which visualizes a **Graphical view** pane and a **Table view** pane showing details on the selected elements.



The overview tabs (, **Profiles Overview**, , **Layers Overview** and , **Rotations Tables**) in the **Table view** can be opened from the toolbar at the top of the window. Via the **Zoom In**, **Zoom Out** and **Zoom 100%** toolbar buttons you may zoom in and out of the **Graphical view**.

In the **Status line** at the bottom the current local coordinates of the mouse pointer in the Graphical view are indicated. It also shows the current unit settings.

The Tunnel Profile Editor offers the following functionality:

Creating tunnel profile data:

To manually create tunnel profiles select **New** from the **File** main menu. Profile data that has been loaded before will be closed.

Opening tunnel profile data:

To open already existing tunnel profile data (stored in a *.tpe file) select **Open** from the **File** main menu. *.tpe files are files created with and stored from within the Tunnel Profile Editor and contain tunnel profile data like profiles, layers and rotations (without the tunnel alignment).

Importing tunnel profile data from LandXML files:

To import tunnel profile data from an *.xml file select **Import...** from the **File** main menu. In the **Import Profiles** dialog select **Files of type LandXML (*.xml)** and browse to the directory where the *.xml file is stored. The *.xml file contains the same information as the *.tpe file (see above). It can be created either using the Tunnel Profile Editor or a 3rd party application and must follow the structure which is defined in the Leica RoadRunner Add-On documentation.

Importing tunnel profile data from text files:

To import tunnel profile data from an *.txt file select **Import...** from the **File** main menu. In the **Import Profiles** dialog select **Files of type [X Y Radius] ASCII file (*.txt)** and browse to the directory where profile definition file is stored. To get more information on the required file structure see: [Tunnel Profile Editor: Viewing and creating tunnel profiles](#)

Saving profile information:

To save tunnel profile information (profiles, layers, rotations) for further use in the Tunnel Profile Editor select **Save** from the **File** main menu. A *.tpe file will be written.

Saving profile information as a LandXML file:

To save tunnel profile information (profiles, layers, rotations) as an *.xml file select **Export to LandXML** from the **File** main menu. An *.xml file according to the Leica RoadRunner Add-On documentation will be created.

Note:

- The linear units can be set to either Meter, Feet Int. or US Survey Feet as long as there is no setting already available from the imported data.
- The rotation units for the tunnel profile rotations can be set to Percent, Decimal degrees or Gons.

See also:

[Viewing and creating tunnel profiles](#)

[Viewing and creating layers](#)

[Viewing and creating profile rotation tables](#)



Tunnel Profile Editor: Viewing and creating tunnel profiles

A profile defines the shape of the tunnel at a certain chainage (station).

To get an overview on the available tunnel profiles:

- Select **Profiles** from the **Tunnel** main menu or click the  **Profiles** toolbar button. Already existing profiles will be displayed graphically and listed in the table view. Profiles can be created, modified and deleted.

To create a profile:

1. In the  **Profiles Overview** tab right-click and select **Add** from the context menu. Name the Profile via in-line editing and double-click on it to open the  **Profile Definition** tab.
2. Right-click into the **Profile Definition** tab and select **Add** from the context menu to create the segments of the tunnel profile.



The profile will be displayed in the Graphical view showing the selected segment highlighted (in red).

The segments are defined by segment **Type (Line or Curve)** and its **Start and End point** coordinates relative to the tunnel axis (centre-line of the tunnel). The x-axis is the horizontal axis and the y-axis is the vertical axis. Note that curve segments must not exceed 180°.

To import a profile:

You may also import tunnel profiles pre-defined either in a LandXML file or a *.txt text file:

1. From the File main menu select **Import...**
2. In the **Import Profiles** dialog select **Files of type LandXML (*.xml)** if your profile definition is stored in the LandXML format and browse to the directory where the LandXML file is stored.

Select **Files of type [X Y Radius] ASCII file (*.txt)** if your profile definition is stored in a *.txt file format and browse to the directory where profile definition file is stored.
3. If the profile definition is stored in a *.txt file and in this text file the linear units are not defined, select a linear unit for the data in the **Select Unit** dialog.
4. The new profile will be added to the  **Profiles Overview** tab. Double-click on it to open its  **Profile Definition** tab.

Note, that the X-, Y-, Radius values of a segment in a profile definition **text file** may be separated by a space, a comma or a semi-colon or they may be tab-delimited. Use the dot "." for real values (e.g. X = 2.98). For each segment enter a new line.

[Example of an \[X Y Radius\] ASCII file \(*.txt\):](#)

A text file with the following content:

```
-5 -0.01
-5 0
-5.02 0
-5.02 1 8.0
2.98 1
2.98 0
2.96 0
2.96 -0.01
```

delivers the following  **Profile Definition after Import:**

	X	Y	Type	Radius	Length	Center X	Center Y
▶	-5,000	-0,010	Linie ▼		0,010		
	-5,000	0,000	Linie ▼		0,020		
	-5,020	0,000	Linie ▼		1,000		
	-5,020	1,000	Kurve ▼	8,000	8,378	-1,020	-5,928
	2,980	1,000	Linie ▼		1,000		
	2,980	0,000	Linie ▼		0,020		
	2,960	0,000	Linie ▼		0,010		
	2,960	-0,010	▼				



Tunnel Profile Editor: Viewing and creating layers

A Layer defines the shape of the tunnel by Profile assignments and Rotations for a certain construction phase (e.g. the initial cut or the final concrete layer).

To get an overview on the available tunnel layers:

- Select **Layers** from the **Tunnel** main menu or click the  **Layers** toolbar button. Already existing layers will be displayed graphically and listed in the table view. Layers can be created, modified and deleted.

To create a layer:

1. In the  **Layers Overview** tab right-click and select **Add** from the context menu. Name the Layer via in-line editing and double-click on it to open the  **Layer Definition** tab.
2. Right-click into the **Layer Definition** tab and select **Add** from the context menu to define the profile assignments for the new layer.

The profile will be displayed in the Graphical view showing the selected segment highlighted (in red). The layer will be displayed in the Graphical view above and in the Cross-section view to the right showing the selected profile highlighted (in Red).

The final settings for the new layer can be set in the **Layers Overview** tab.

3. Define the profile **Type** (**Vertical** or **Perpendicular** to the tunnel axis) and profile **Rotations** (if there are any).

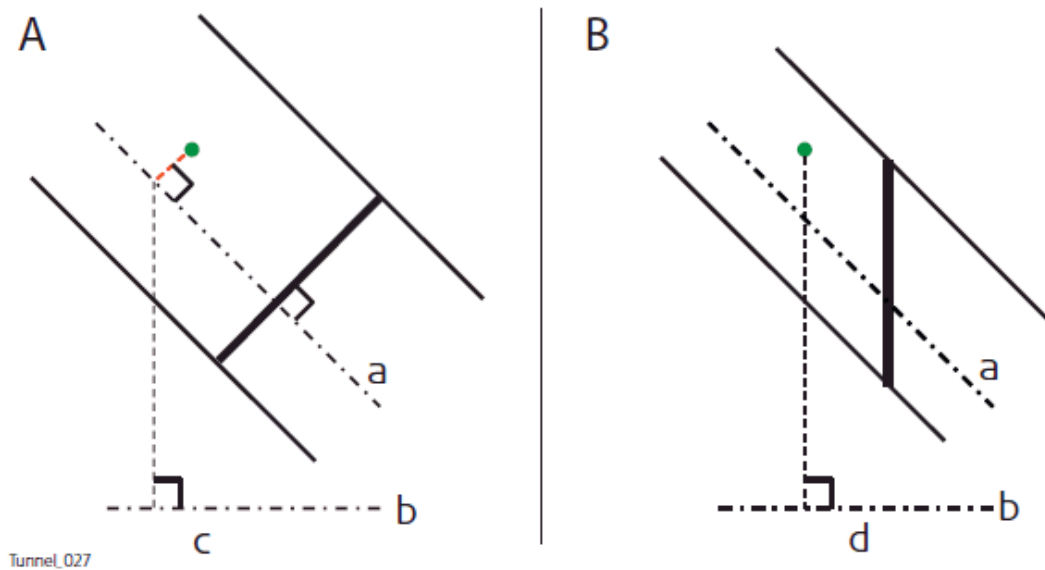

A shows a **perpendicular** tunnel profile.

B shows a **vertical** tunnel profile.

Tunnel Profile Editor: Viewing and creating profile rotation tables

Rotations define if and how a tunnel profile has to be rotated. This allows to use a profile also in curves where it can be tilted to the left or to the right.

To get an overview on the available rotation tables:

- Select **Rotations** from the **Tunnel** main menu or click the  **Rotations** toolbar button. Already existing rotation tables will be displayed graphically and listed in the table view. Rotation tables can be created, modified and deleted.

To create profile rotation tables:

1. In the  **Rotation Tables** tab right-click and select **Add** from the context menu. Name the Rotation table via in-line editing and click on it to open it in the bottom right pane.
2. Right-click into the bottom right pane and select **Add** from the context menu to define the rotation values and their offsets from the tunnel axis. The units will be set as indicated in the status bar.

The rotation will be displayed in the Graphical view showing the selected rotation highlighted (in red).

Customize

Customize...

Enables you to customize the Toolbars.

See also: [Toolbars](#)

Reset a Toolbar

Enables you to reset a Toolbars or menu bars to the original settings.

1. From the **View** menu select **Toolbars...**
2. From the **Toolbars** list the Toolbar to reset.
3. Click on the **Reset** button.
4. Click **Close** to confirm.

Options

Options...

The Options Property-Sheet enables you to configure some global settings.

1. From the **Tools** menu select **Options...**
2. Select between the following tabs and make your settings:

- General
- Units/ Display
- Default Parameters
- Internet
- Linework
- PZ-90
- CAD Import

3. Press **OK** to confirm or **Cancel** to abort the function.

Options: General

Show splash window on startup:

Click the checkbox to enable or disable displaying the Leica startup logo.

Open last used views on startup:

Click the checkbox to display the last used views upon starting LGO or Flex Office.

Text editor:

Select path and executable file of your preferred text editor program. The text editor program is used to view files in the [Data Exchange Manager](#) and to edit scripts in the [Script Management](#) component.

Local memory device drive:

Enter the location of your local memory device drive here (CF-card or SD-card or Viva USB stick).

Threshold to merge reference triplets:

If during Import a Reference triplet needs to be created for a point for which there already exists another Reference triplet, this setting allows you to specify the maximum coordinate difference below which an automated merging of the reference coordinates to be imported and the existing reference coordinates shall be allowed. To enforce that Reference triplets will never be merged automatically you have to de-select this option. A separate instance of the point ('Point Id (2)') will be created, which can always later be merged manually. See also: [Merging Reference Coordinates during Import](#)

Always merge reference triplets...:

This setting allows you to always merge Reference triplets during Import with Reference triplets that may already exist in the selected project, even if a coordinate system is required but not available. See also: [Merging Reference Coordinates during Import](#)

Deactivated messages:

Click on the **View** button to see a list of all de-activated message and warning boxes. Message boxes appear e.g. upon performing an illegal command. Warning boxes appear e.g. upon deleting data. Per default all message and warning boxes are enabled. To disable a message box tick **Do not prompt in future**. To get it back on the screen again re-activate the message in the [Messagebox Management](#).

Warning before import...

Check this option if a warning message shall be issued during raw data import when the number of points exceeds a certain limit.

Note: Theoretically there is no limit for importing points. However if you are importing a large number of points (especially automatically recorded points) and the performance of your PC is slow, the import process can take a long time.

Options: Units/ Display

This dialog page enables you to define the global Units and Display settings:

Linear units:

Select the linear units from the combo box:

- **Metres (m)**
- **US Survey feet (fts)** = 1200 / 3937 metres (used within USA only)
- **International feet (fti)** = 0.3048 metres

Decide on how many **Decimal places** shall be displayed for the chosen linear unit. You may select from a range between 1...5. The system default value is 4.

Angular units:

Select the angular units from the combo box:

- **Degree [dec]** (decimal degree)
- **DMS** (Degree, Minutes, Seconds)
- **Decimal Gon [gon]**

Decide on how many **Decimal places** shall be displayed for the chosen angular unit. You may select from a range between 1...5. For **DMS** decide on how many decimal places shall be displayed for the **Seconds**.

Note: This setting does not affect Latitude and Longitude values, Classical 3D transformation parameters and map projection properties.

Time format:

Select the desired time and date format from the combo box.

Apply leap seconds to all GPS times:

Click this checkbox if you want to apply the leap seconds when converting from GPS time to local time.

Coord. order:

Select the desired coordinate order from the combo box. You may choose between:

- **Easting, Northing** (system default)
- **Northing, Easting**

Whichever choice you make, it is remembered for future applications and applies globally to all property sheets and pages that display the chosen coordinate order.

It does not apply to any Report View or Property View, though. Changing of the column order can be achieved by drag and drop of columns!

Coordinate directions of grid view:

Switch Northing: Click this checkbox if you want to have the Northing-axis pointing to the South.

Switch Easting: Click this checkbox if you want to have the Easting-axis pointing to the left.

Displayed height for local grid view:

From the combo box select the height mode in which the height value shall be displayed for points in the **View/ Edit** or the **Adjustment** component or in the **Cogo Map view**. By default **Orthometric** will be selected.

Note: This setting will only be applied if the graphical view is configured to display *local grid* coordinates.

Options: Default Parameters

This dialog page enables you to set the **Default GPS-processing**, **Level-processing**, **Traverse-processing** and **Adjustment** Parameters. Additionally, you can select the behaviour of the GPS-processing, the Level-Processing and the Adjustment component after processing.

GPS-Processing

Default Parameters:

Click on the **Configure...** button to configure the default processing parameters. The settings will be used as default for each new project you create. See also: [GPS-processing Parameters](#).

Note:

- The pages for setting the default values of the GPS-processing parameters look very much alike those for editing project-specific values. The differences are:

Selecting or de-selecting the 'Show advanced parameters'-option does not make the respective tabs appear or disappear, but rather sets the Hide/ Show-status of these pages on the project-specific level.

The 'Active satellites' list box will not be available for default settings, since this is a project-specific feature.

Enable keyboard entry for windowing:

If this option is ticked you will by default be enabled to manually edit [windows for individual observation intervals](#) to be included or excluded in the computation. The same applies for the [satellites view](#).

Post-processing behaviour:

- **No automatic behaviour:**
If this option is selected the data-processing will NOT switch to the Results-View after processing and the results will have to be stored manually.
- **Switch to result and select using criteria: (Default):**
If this option is selected the [Results View](#) will be activated after processing showing the [Point Results](#). The points will be selected based upon the settings of the [Selection Criteria](#).
- **Auto store based upon criteria:**
If this option is selected the points will automatically be stored after processing based upon the settings of the [Selection Criteria](#). The view will not switch to the Results View.

Level-Processing

Default Parameters:

Click on the **Configure...** button to configure the default processing parameters. The settings will be used as default for each new project you create. See also: [Level-processing Parameters](#).

Post-processing behaviour:

- **No automatic behaviour:**
If this option is selected the processing will NOT switch to the Results-View after processing and the results will have to be stored manually.
- **Switch to results (Default):**
If this option is selected the [Results View](#) will be activated after processing showing the [Point Results](#).
- **Auto store all:**
If this option is selected the points will automatically be stored after processing.

Traverse-Processing

Default Parameters:

Click on the **Configure...** button to configure the default processing parameters. The settings will be used as default for each new project you create. See also: [Traverse-processing Parameters](#).

Adjustment

Default Parameters:

Click on the **Configure...** button to configure the default General Adjustment parameters. The settings will be used as default for each new project you create. See also: [General Adjustment Parameters](#)

Additionally, you can decide whether you want to store the results of an adjustment immediately after computing, or store the results separately at a later point in time. By default the **Store results immediately after computing** option is checked. When you change this setting, this has immediate effect and applies to any projects which are already open.

When you changed the configuration such that the results are not immediately stored, you are given the opportunity to store the adjusted values by a separate command either from the main Adjustment menu or the Adjustment context menu.

Note:

- As soon as the configuration is changed to storing the adjustment results immediately after computing the store menu item disappears. To get the adjusted coordinates stored automatically, the computation has to be repeated.
- If manual storage is selected and a new adjustment is computed before the existing results have been stored, the results are overwritten as soon as **Compute** is invoked. However, if the computation is unsuccessful then, there will not be any adjusted triplets to be stored and the Store menu item will be disabled.
- With storing the results of a 3D adjustment in LGO all [GPS Hidden Points](#) contained in a project will be re-computed automatically independently of whether the adjustment results are set to be stored automatically or manually.

Options: Internet

In order to support the download of RINEX raw data or Precise Ephemeris from the Internet LGO presents you with the [Internet Download](#) tool. What you have to decide on, is whether you want to select an observation site **manually** or **automatically**. Make your choice, and pick one or the other from the corresponding combo box.

Manual site selection:

If you choose to select the site manually, there will be no further options for you to decide on on this page. All possible settings are disabled. Press the **OK**-button to accept your selection as the working mode for the Internet Download.

Automatic site selection:

If you choose to have automatic site selection, all settings are enabled according to the radio button selection. You may decide on

- the maximum number of sites **or**
- the maximum distance to sites

If you go for the **Maximum number of sites**-setting, a selection of sites will be located according to the specified amount, with the search proceeding from the closest to the furthest away, based upon the coordinates specified below.

If you go for the **Maximum distance to sites**-setting, all those sites will be located, which lie within the maximum distance (in km) from the coordinates specified below.

For both options there are additional fields to enter the coordinates for the **Latitude** and **Longitude** of the search start location.

Press the **OK**-button to accept your selection as the working mode for the Internet Download.

Options: Linework

This dialog page enables you to define the strings which will be exported when selecting the variable **Linework** in the Lines or Areas **Exportstring** of a **Format Manager template** file. The specified strings will then be exported using the **Custom ASCII File Export**.

The following linework strings can be selected:

Begin of line:

Defines the string which will be exported for the first point of a line. If a line starts with an arc or with a spline then the linework strings defining the begin of the arc or spline will be exported.

Begin of area:

Defines the string which will be exported for the first point of an area.

Begin of 3 point curve:

Defines the string which will be exported for the first point of an arc.

Line/Area open:

Defines the string which will be exported for all points, where none of the other strings gets exported.

Begin of spline:

Defines the string which will be exported for the first point of a spline.

Spline open:

Defines the string which will be exported for all points between the start and the end point of a spline.

End spline:

Defines the string which will be exported for the last point of a spline. If the last point of the spline is **simultaneously** the start point of a 3 point curve or the end of the line or the last point in an area (which has to be closed with a straight line after the end of the spline) then the 'End Spline' string will be **overridden** by the corresponding strings for 'Begin of a 3 point curve' or for 'End line' or for 'Close area'.

End line:

Defines the string which will be exported for the last point of a line.

Close area:

Defines the string which will be exported for the last point of an area.

Options: PZ-90

This dialog page enables you to define the transformation parameters between the WGS84 coordinate system and the **PZ-90** coordinate system, in which the **GLONASS** satellite ephemeris are stored.

- Enter the values and press **OK** to apply the changes. Press the **Default** button to recall the default parameters.

PZ-90 parameters can also be transferred to a SmartWorx GPS instrument.

- Decide whether you want to transfer the parameters to a location on the **Hard Disk** or to the **Local memory device drive** defined under **Tools Options: General** and press **Send To...**

When selecting **Local memory device** the PZ-90 parameters are sent directly to the appropriate subdirectory on the card. If this subdirectory does not already exist, it will be created.

On the instrument use the **Transfer** command to copy the PZ-90 transformation to the **System Memory**.

- To import PZ-90 transformation parameters press **Import...** and browse to the file TRFSET.DAT.

Options: CAD Import

This dialog page enables you to define global settings for the import of CAD entities into an LGO project.

Default point class:

Select the class which imported points shall get on creation in LGO. You may choose between *Estimated* and *Control*.

Point prefix:

Define a specific prefix for points that are imported into a project from a CAD background map. This enables you to distinguish points being imported from CAD from other points. The default suggestion for CAD points is **CEP** (CAD Entity Point) plus an incremented number.

Line prefix:

Define a specific prefix for lines that are imported into a project from a CAD background map. This enables you to distinguish lines being imported from CAD from other lines. The default suggestion for CAD lines is **CEL** (CAD Entity Line) plus an incremented number.

Area prefix:

Define a specific prefix for areas that are imported into a project from a CAD background map. This enables you to distinguish areas being imported from CAD from other areas. The default suggestion for CAD areas is **CEA** (CAD Entity Area) plus an incremented number.

Add default height to 2D elements:

If you select this option then you may specify a default height value that shall be applied to 2D entities on import. When you import CAD entities with this option checked then any entity being imported that does not have a height will be imported as 3D with the default height being used.

Height to exclude:

In the CAD file you may define points with an extraordinary height value if you want to ensure that these points are recognized as 2D. In LGO you may set the same value here to ensure that the height of these points is excluded on import and the points are stored as 2D.

Create area object for closed polyline/ spline object:

If you select this option then CAD entities of type polyline or spline which end up on their start point and are thus closed will be converted into an Area object in LGO. If you do not select this option they will be converted into a Line or Spline in LGO.

Messagebox Management

Each of the Message Boxes may be switched off, so that you will not be prompted in the future.

- To do so tick **Do not prompt in future**.

To get the message back on the screen it has to be switched on again. This can be achieved in the **Messagebox Management**.

By default all Message Boxes are enabled. Those that have been manually disabled are listed in the **Messagebox Management** dialog. All de-activated messages are grouped by the software components they belong to. To re-activate a message:

- Select the corresponding software component from the tree-view and tick the message to be re-activated in the right-hand report-view.
- Leave the Messagebox Management with **OK**.